

Lighting

& BULBS COLLECTION

ΚΑΤΑΛΟΓΟΣ
ΕΠΑΓΓΕΛΜΑΤΙΚΟΥ
ΦΩΤΙΣΜΟΥ &
ΛΑΜΠΤΗΡΩΝ

2025

Pioneers in new technology!

EUROLAMP®

Lighting

COLLECTION

ΚΑΤΑΛΟΓΟΣ
ΕΠΑΓΓΕΛΜΑΤΙΚΟΥ
ΦΩΤΙΣΜΟΥ &
ΛΑΜΠΤΗΡΩΝ

2025

EUROLAMP®



EUROLAMP[®]

Η **EUROLAMP** είναι μια συνεχώς αναπτυσσόμενη ελληνική εταιρεία που πρωτοπορεί και καινοτομεί, κάνοντας τη διαφορά εδώ και 25 χρόνια! Πρόκειται για μια δυναμικά εξελισσόμενη εταιρεία με νέα προϊόντα σύγχρονης τεχνολογίας, που ανταποκρίνονται στις απαιτήσεις του σύγχρονου εμπορίου, είναι φιλικά προς το περιβάλλον και συμμορφώνονται με όλους τους ευρωπαϊκούς και διεθνείς κανονισμούς.

Διαθέτει μια ευρεία γκάμα προϊόντων φωτισμού (οικιακής και επαγγελματικής χρήσης), λαμπτήρες, ηλεκτρολογικό εξοπλισμό, χριστουγεννιάτικο φωτισμό και διακόσμηση, κλιματιστικές μονάδες ZEPHYRUS - AERE, ηλεκτρικές συσκευές, μπαταρίες, φωτοβολταϊκά συστήματα LIGHTBORN SYSTEMS, προϊόντα ηλεκτροκίνησης EMOOV (ηλεκτρικά scooters και sea-scooters) καθώς και είδη διακόσμησης ESTHETI.

Διατηρεί αξιόπιστες και μακροχρόνιες συνεργασίες και διαθέτει ένα ισχυρό δίκτυο πωλήσεων με περισσότερα από 3.000 σημεία πώλησης στην Ελλάδα, την Κύπρο και σε περισσότερες από 30 χώρες εντός και εκτός ΕΕ.

Επένδυση στο μέλλον

Το 2024, η EUROLAMP ολοκλήρωσε επένδυση ύψους 15 εκατομμυρίων ευρώ, φέρνοντας όλες τις δραστηριότητες της εταιρείας σε ένα νέο, σύγχρονο επιχειρηματικό συγκρότημα. Αυτό περιλαμβάνει ένα υπερσύγχρονο κέντρο logistics, νέα γραφεία, εκθεσιακούς χώρους, αναβαθμισμένο τεχνικό και IT εξοπλισμό, τα οποία, σε συνδυασμό με την εμπειρία, την τεχνογνωσία και τις γνώσεις του ανθρώπινου δυναμικού, διασφαλίζουν την άριστη εξυπηρέτηση των πελατών.

Οι αξίες μας

- Σεβασμός στον πελάτη με συνέπεια και αξιοπιστία
- Προσωπικό και επιχειρηματικό ήθος
- Δημιουργία αδιάρρηκτων σχέσεων με τους συνεργάτες μας
- Καινοτομία και συνεχής εξέλιξη
- Υψηλή ποιότητα προϊόντων και υπηρεσιών
- Εκπαίδευση και ανάπτυξη του προσωπικού



EUROLAMP is a constantly growing Greek company that pioneers and innovates, making a difference for 25 years!

Is a constantly evolving company with new products of modern technology that meet the requirements of modern trade, are environmentally friendly and follow all the European and International Legislation rules.

Has a wide variety of lighting products (domestic and professional use), bulbs, electrical equipment, Christmas lighting and decoration, air conditioning units ZEPHYRUS - AERE, electrical appliances, batteries, photovoltaic systems LIGHTBORN SYSTEMS, EMOOV electric mobility products (e-scooters and sea-scooters) and home decoration items ESTHETI.

Maintains reliable and long-term partnerships and has a strong sales network with more than 3,000 selling points in Greece, Cyprus and more than 30 countries inside and outside the EU.

An investment to the future

In 2024, EUROLAMP completed a 15 million euros investment, bringing all company's activities into a new modern business complex. This includes a high-end logistics center, new offices, showrooms, upgraded technical and IT equipment, which in combination with the experience, expertise and knowledge of human resources ensure an excellent customer service.

Our values

- Respect with consistency and reliability
- Personal and business ethics
- Creating unbreakable relationships with our partners
- Innovation and continuous development
- High quality products and services
- Continuous investment in human resources

EUROLAMP SA GREECE

3rd km Symmachiki Road.
57013 Oraiokastro.
Thessaloniki. Greece
Tel: +30 2310 574802
Fax: +30 2310 574919
Email: info@eurolamp.gr
www.eurolamp.gr

EUROLAMP BELGIUM SRL

Rue Des Artisans 4B
6210 - Frasnes Lez Gosselies
Belgique
Siège Social +32 (0) 493 444 162 (FR/EN)
Délégué Wallonie +32 (0) 492 245 612 (FR)
Email: info@eurolamp.be

EUROLAMP SA CHINA

Rm1101-1106. JiuYou Mansion
No.1158 Huyi Highway
Nanxiang Town. Jiading District
201800 Shanghai / P.R. China
Tel: +86-21-64379558
Fax: +86-21-64722682

Get in touch!

Ελάτε σε επαφή μαζί μας!

Η Eurolamp έχει παρουσία σε μια ποικιλία μέσων κοινωνικής δικτύωσης στα οποία μπορείτε να παρακολουθείτε την εξέλιξη της εταιρείας αλλά κυρίως τα καινοτόμα προϊόντα και λύσεις που διαθέτουμε!

Eurolamp has a presence on a variety of social media where you can follow the development of the company but mainly the innovative products and solutions we can provide to you and to your customers!

facebook  **YouTube**  **LinkedIn**  **Instagram**

Σκανάρετε το QR code και βρείτε μας στο κοινωνικό μέσο της επιλογής σας



Scan the QR code and find us on the social media of your choice



Banking Accounts

Τραπεζικοί λογαριασμοί

Στοιχεία τραπεζικών λογαριασμών **EUROLAMP ABEE**
EUROLAMP SA banking accounts

ΕΘΝΙΚΗ ΤΡΑΠΕΖΑ / NBG: 224/470122-40
IBAN: GR79 0110 2240 0000 2244 7012 240

ΤΡΑΠΕΖΑ ΠΕΙΡΑΙΩΣ / PIRAEUS BANK: 5229-063351-500
IBAN: GR26 0172 2290 0052 2906 3351 500

ALPHA BANK: 703 00 2002 016002
IBAN: GR86 0140 7030 7030 0200 2016 002

EUROBANK: 0026.0216.91.0200622333
IBAN: GR72 0260 2160 0009 1020 0622 333

Στοιχεία τραπεζικών λογαριασμών Βελγίου **EUROLAMP BELGIUM SPRL**
EUROLAMP BELGIUM SPRL banking accounts

BENEFICIARY NAME: EUROLAMP BELGIUM SPRL
BENEFICIARY ADDRESS: Rue Des Artisans 4B
6210 - Frasnes Lez Gosselies - Belgique
BANK: AXA BANK BELGIUM
IBAN ACCOUNT: BE87751207895894
BIC: AXABBE22

Certifications

Πιστοποιήσεις



ISO 14001:2015
ISO/IEC 27001:2013
ISO 45001:2018
ISO 13485:2016



ΥΠΟΥΡΓΙΚΗ ΑΠΟΦΑΣΗ
ΔΥ86/Γ.Π. ΟΙΚ/1348/2004
ISO 9001:2015



ISO 37001
ISO 39001
ISO 26000:2010



ISO 5001:2018



ΣΥΜΠΛΗΡΩΣΤΙΚΟ ΣΥΣΤΗΜΑ
ΕΝΔΕΛΤΙΚΗΣ ΔΙΑΧΕΙΡΙΣΗΣ ΦΟΡΤΙΩΝ
ΗΛΕΚΤΡΙΚΩΝ ΣΤΗΛΩΝ



ΦΩΤΟΚΥΚΛΩΣΗ



Παροχή προϊόντων και υπηρεσιών σύμφωνα με τις κορυφαίες προδιαγραφές και απαιτήσεις ποιότητας

Η προσήλωση της Εταιρείας στην Ποιότητα είναι δεδομένη, αδιαμφισβήτητη και συνοδεύει την καλή της φήμη. Για το λόγο αυτό, η Διοίκηση της Εταιρείας, έχει καθορίσει ως ανώτερο αντικειμενικό σκοπό την αυστηρή εφαρμογή και διατήρηση Ενιαίου Συστήματος Διαχείρισης Ποιότητας, Διαχείρισης Ιατροτεχνολογικού Εξοπλισμού, Περιβαλλοντικής Διαχείρισης, Επιχειρησιακής Συνέχειας, Εταιρικής Κοινωνικής Ευθύνης, Καταπολέμησης της Δωροδοκίας, Διαχείρισης της Οδικής Ασφάλειας, Υγείας & Ασφάλειας στην Εργασία και Διαχείρισης της Ενέργειας, σύμφωνα με τα νέα πρότυπα ISO 9001:2015, ISO 13485:2016, ISO 14001:2015, ISO 22301:2019, ISO 26000:2010, ISO 37001:2016, ISO 39001:2012, ISO 45001:2018 και ISO 50001:2018, καθώς και τη συνεχή βελτίωση, του εν λόγω Ενιαίου Συστήματος.

Η εταιρεία έχοντας εισαχθεί στον κλάδο των βιοκτόνων και ιατροτεχνολογικών προϊόντων λειτουργεί σύμφωνα με το πρότυπο ISO 13485 και την Υ/Α 1348 ώστε να διασφαλίζεται η ασφαλής και ακίνδυνη για την υγεία διανομή των προϊόντων. Πιστοποιημένα προϊόντα για ασφαλή χρήση με βάση την Ευρωπαϊκή και Διεθνή νομοθεσία και εφόσον απαιτείται διαθέτουν έγκριση από τον ΕΟΦ, έγκριση από τον Ευρωπαϊκό Οργανισμό Χημικών Προϊόντων ECHA και καταχώριση στην ευρωπαϊκή βάση δεδομένων συμμορφούμενα με την κοινοτική και εθνική νομοθεσία.

Επίσης, εγκατέστησε ένα σύστημα διαχείρισης ασφάλειας πληροφοριών που είναι σύμφωνο με το πρότυπο ISO 27001:2013 και θα ενημερωθεί σύμφωνα με το νέο πρότυπο ISO/IEC 27001:2022.

Με όραμα την αιεφόρο ανάπτυξη δεσμεύεται για την προσπάθεια μείωσης της ενεργειακής κατανάλωσης και των εκπεμπόμενων ρύπων που αφορούν στις δραστηριότητες παραγωγής και εμπορίας ηλεκτρολογικού υλικού στις κεντρικές εγκαταστάσεις της στο Ωραιόκαστρο Θεσσαλονίκης μέσω του συστήματος ενεργειακής διαχείρισης σύμφωνα με το πρότυπο ISO 50001:2018.

Products supply and services according to the highest quality and specifications requirements

The Company's commitment to Quality is given, indisputable and accompanies its good reputation. For this reason, the Company's Management has determined as a higher objective the strict implementation and maintenance of the Unified Quality Management System, Quality Management System of Medical Devices, Environmental Management System, Business Continuity Management System, Corporate Social Responsibility Management System, Anti-Bribery Management System, Road Safety Management System, Occupational Health and Safety Management System, Energy Management System according to the standards ISO 9001:2015, ISO 13485:2016, ISO 14001:2015, ISO 22301:2019, ISO 26000:2010, ISO 37001:2016, ISO 39001:2012, ISO 45001:2018, ISO 50001:2018, as well as the continuous improvement of the Unified System.

The company having entered in the field of the biocidal products and medical devices products, it operates according to ISO 13485 standard and Ministerial Decision 1348, so as to secure the safe and harmless for health products distribution. It markets certified products for safe use according to European and international law, which have the National Organization for Medicines approval wherever imposed, European Chemicals Agency approval as well as the registration in the European database and are compliant to the European and national legislation.

Additionally the company has installed an information safety system, which is in accordance to ISO 27001:2013 standard and it will be updated to ISO/IEC 27001:2022 standard.

With a vision to sustainable development EUROLAMP SA is committed to an effort to limit power consumption and emitted pollutants from production activities and electrological supply trade at our central facilities at Oraiokastro Thessaloniki through the energy management system according to ISO 50001:2018 standard.

Στον κατάλογο μας, σε κάθε κωδικό θα βρείτε και το barcode του. Με την εφαρμογή EUROLAMP B2B μπορείτε να σκανάρετε το barcode που επιθυμείτε και να κάνετε την παραγγελία σας εύκολα και γρήγορα! Ζητήστε μας να σας αποστείλουμε τους κωδικούς πρόσβασης!

Σχεδιασμένη και δομημένη σε πλήρη αρμονία με τη διαδικτυακή πλατφόρμα B2B, έρχεται να συμπληρώσει στο έπακρο όλες τις δυνατότητες που θα θέλατε να έχετε από ένα Ψηφιακό Πολυ-εργαλείο! Εντοπίστε τα προϊόντα που σας ενδιαφέρουν, αναζητήστε νέα προϊόντα, προσφορές και προωθητικές ενέργειες, επαληθεύστε τη διαθεσιμότητα των κωδικών και την ημερομηνία παραλαβής των προϊόντων στις αποθήκες μας, προσθέστε κωδικούς στη παραγγελία σας απλά σκανάροντας το προϊόν και κρατείστε τον έλεγχο των παραγγελιών σας! Όλα αυτά μέσω του κινητού σας!

- Διαθεσιμότητα των προϊόντων
- Ημερομηνία παραλαβής των προϊόντων στις αποθήκες μας
- Καταχώρηση παραγγελίας
- Παρακολούθηση της εξέλιξης της παραγγελίας
- Πρόσβαση σε οικονομικά στοιχεία

Τώρα μπορείτε να έχετε στο κινητό σας όλες τις πληροφορίες που χρειάζεστε άμεσα και εύκολα με ένα scroll! Κατεβάστε τη νέα mobile εφαρμογή EUROLAMP B2B από το App Store (iOS) ή το Play Store (ANDROID).

* Για οποιαδήποτε επιπρόσθετη πληροφορία σχετικά με την εφαρμογή EUROLAMP B2B App παρακαλούμε απευθυνθείτε στον πωλητή που σας εξυπηρετεί.

In our catalog, in each code you will find its barcode. With the EUROLAMP B2B application you can scan the barcode you want and place your order easily and quickly! Ask us to send you the passwords!

Designed and built in complete harmony with the B2B web platform, it comes to fill to the fullest all the possibilities you would like to have from a Digital Multi-tool! availability of codes and the date of receipt of products in our warehouses, add codes to your order simply by scanning the product and keep control of your orders! All this through your mobile!

- Availability of products
- Delivery date of the products in our warehouses
- Order entry
- Monitoring progress of the order
- Access to financial data

Now you can have all the information you need on your mobile phone instantly and easily with one scroll!

*Download the new EUROLAMP B2B mobile application from the App Store (iOS) or the Play Store (ANDROID).

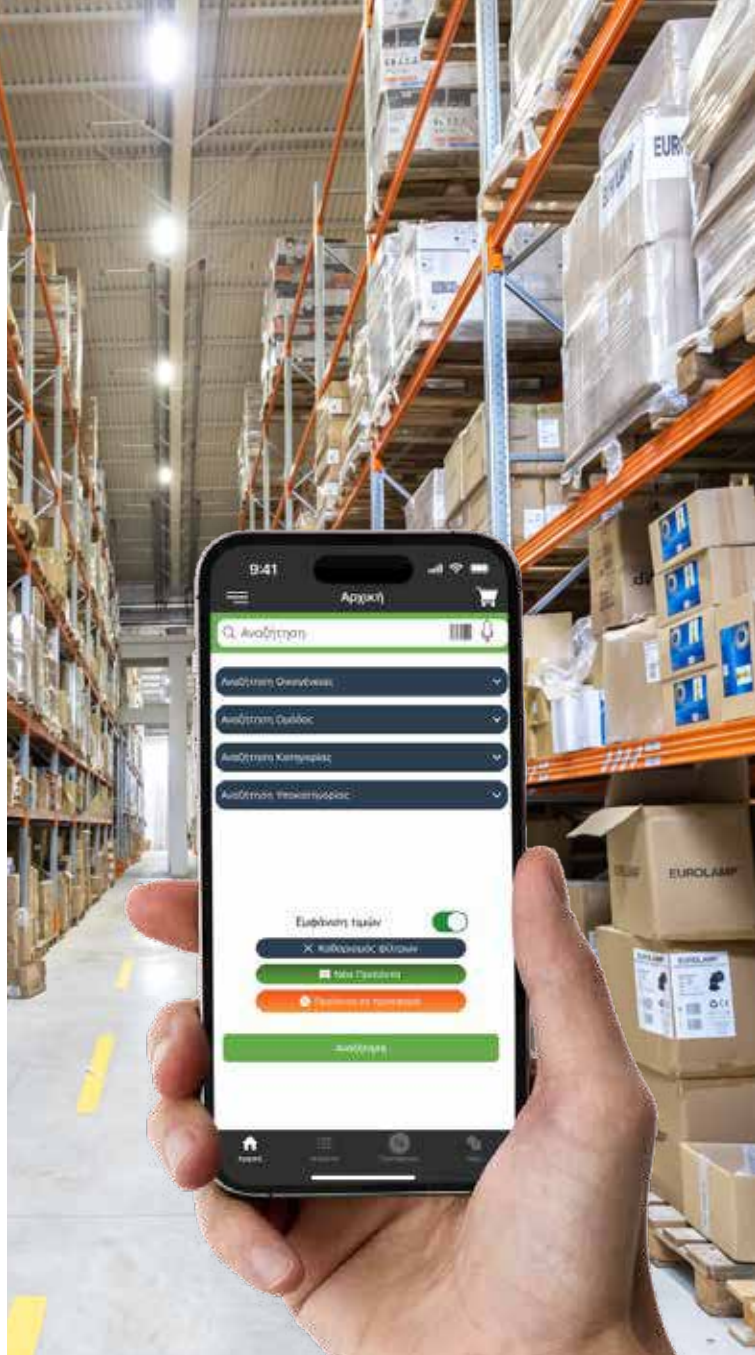

Νέα δυνατότητα
παραγγελίας μέσω του app
EUROLAMP B2B
New ordering feature
through the app

Download & Install





EUROLAMP®

Smart WiFi

Στη γκάμα των έξυπνων συσκευών για το σπίτι από τη EUROLAMP Smart, περιλαμβάνονται λαμπτήρες Wi-Fi, σύστημα ασφαλείας, αντάπτορες ρεύματος, πολύπριζα, «έξυπνα» τηλεχειριστήρια υπέρυθρων (IR remote controller), και εμπλουτίζεται συνεχώς με νέα είδη.

Η εφαρμογή EUROLAMP Smart app είναι εύκολη στη χρήση και είναι πλήρως συμβατή με όλες τις συσκευές EUROLAMP Smart WiFi, αλλά και όλες τις συσκευές που φέρουν την ένδειξη «Powered by TUYA». Άρα με μια εφαρμογή μπορεί ο χρήστης να ελέγξει όλες τις «έξυπνες» συσκευές χωρίς περιορισμούς.

Για την χρήση των Smart προϊόντων, είναι απαραίτητη η εγκατάσταση της εφαρμογής EUROLAMP SMART WI-FI στη συσκευή σας.

The range of smart home appliances from EUROLAMP Smart includes Wi-Fi Lamps, power adaptors, sockets, “smart” infrared remote controls, and new items are added continuously.

The EUROLAMP Smart app is easy to use and is fully compatible with all EUROLAMP Smart WiFi devices, as well as all devices with “Powered by TUYA” indication. The user can manage all the “smart” devices with one application, without restrictions.

For using the Smart Items, the EUROLAMP SMART WI-FI application must be installed to your device

Download & Install



Scan



Απαιτείται Android 4.4 και πάνω, & iOS 9.0 και πάνω.
Requires Android 4.4 or higher, & iOS 9.0 or higher.

Έξυπνο Σπίτι

Smart Home

New Energy Label

Νέα ενεργειακή ετικέτα

Για να βοηθηθούν οι καταναλωτές της ΕΕ να μειώσουν τους λογαριασμούς ενέργειας και το ανθρακικό τους αποτύπωμα, από τη Δευτέρα 1η Μαρτίου 2021, ισχύει μια νέα έκδοση της ευρέως αναγνωρισμένης ενεργειακής ετικέτας της ΕΕ. Ο νέος κανονισμός της Ευρωπαϊκής Ένωσης άλλαξε τον τρόπο υπολογισμού της ενεργειακής κλάσης καθώς και τον τρόπο που αυτή εμφανίζεται στις συσκευασίες.

Να τονίσουμε ότι δεν έχουν γίνει αλλαγές στα προϊόντα στα οποία εμφανίζεται η ενεργειακή κλάση με το νέο τρόπο υπολογισμού - η ποιότητα είναι ίδια καθώς και η απόδοση. Αυτό που έχει αλλάξει είναι ο τρόπος υπολογισμού της ενεργειακής κλάσης σύμφωνα με τον κανονισμό 2019/2015 της Ευρωπαϊκής Ένωσης.

Στους υπολογισμούς για τη νέα ενεργειακή κλάση, πλέον υπολογίζονται πολλοί παράγοντες όπως η κατευθυντικότητα, η τάση λειτουργίας κλπ.

To help EU consumers reduce their energy bills and carbon footprint, a brand new version of the widely recognized EU energy label comes into force from Monday 1 March 2021. The new European Directive which changes the way of calculation of the energy class, and the way which it appears on the packaging.

No changes were made at the products on which the energy class appears with the new energy label. Quality and efficiency are the same. The change which has been made, is the new way of calculation of the energy class, according to the European Directive 2019/2015.

In the calculation for the new energy class, many factors are calculated, such as directivity, operating voltage, etc.



Παλιά Ενεργειακή Ετικέτα Previous Energy Label

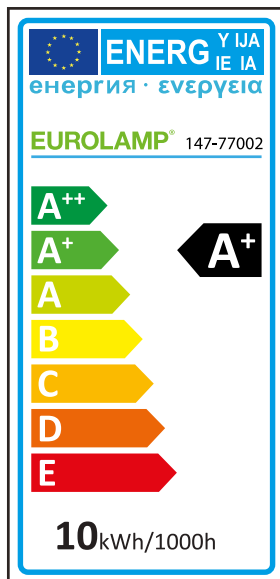

Η ενεργειακή κατανάλωση του προϊόντος

The energy consumption of the product

Νέα Ενεργειακή Ετικέτα New Energy Label

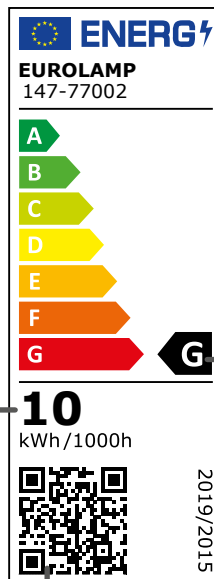

- A >210lm/W
- B >185lm/W
- C >160lm/W
- D >135lm/W
- E >110lm/W
- F >85lm/W
- G >85lm/W

Η ανανεωμένη Ενεργειακή Κλάση του προϊόντος

The rescaled energy efficiency class of the product

Ο κωδικός QR δίνει πρόσβαση στα τεχνικά χαρακτηριστικά του προϊόντος

The QR code gives access to the data sheet of the product

Quality Classifications

Σήμανση ποιότητας



PRO SERIES

Κορυφαία ποιότητα και τελευταία τεχνολογία σε επιλεγμένα προϊόντα για οικιακή και επαγγελματική χρήση. Υψηλά standards ασφάλειας, μεγάλη διάρκεια ζωής και εγγύηση έως 5 έτη.

Premium quality and use of the most recent technological advancements, in a selected group of products that are suitable for domestic and commercial use. Higher safety standards, long lasting lifetime and up to 5 years of warranty.



PLUS SERIES

Σειρά πολύ καλής ποιότητας, σε μεγάλη γκάμα κωδικών για οικιακές, επαγγελματικές και βιομηχανικές χρήσεις.

A Higher Quality series with a wide range of products suitable for domestic, professional and industrial use.



VALUE SERIES

Η κατηγορία περιλαμβάνει προϊόντα οικιακής και εμπορικής χρήσης, υψηλής απόδοσης και χαμηλού κόστους.

This category consists of high efficiency and low in cost products, that are suitable for general domestic and commercial applications.

What is CRI and Its Importance in LED Lighting

Τι είναι ο CRI και η σημασία του στον φωτισμό LED

CRI είναι τα αρχικά του **Color Rendering Index - Δείκτης Απόδοσης Χρωμάτων**. Είναι μια μονάδα μέτρησης που αξιολογεί την ικανότητα μιας πηγής φωτός να αναπαράγει τα χρώματα των αντικειμένων με μεγαλύτερη ακρίβεια και πιστότητα, συγκριτικά με μια ιδανική πηγή φωτός, όπως το ηλιακό φως.

Η τιμή του CRI κυμαίνεται από 0 έως 100, όπου το 100 αντιπροσωπεύει την τέλεια απόδοση των χρωμάτων.

Μια λάμπα με CRI 80 θεωρείται καλή, αλλά με CRI 90 ή υψηλότερο, τα χρώματα αποδίδονται ακόμα πιο φυσικά. Αντίθετα, ένας CRI κάτω από 80 μπορεί να προκαλέσει αλλοίωση των χρωμάτων, δίνοντάς τους μια κιτρινωπή ή ξεθωριασμένη όψη, ενώ ενδέχεται να αλλάξει ακόμη και την απόχρωση των αντικειμένων.

CRI stands for **Color Rendering Index**. It is a measurement unit that evaluates a light source's ability to reproduce the colors of objects with greater accuracy and fidelity compared to an ideal light source, such as sunlight.





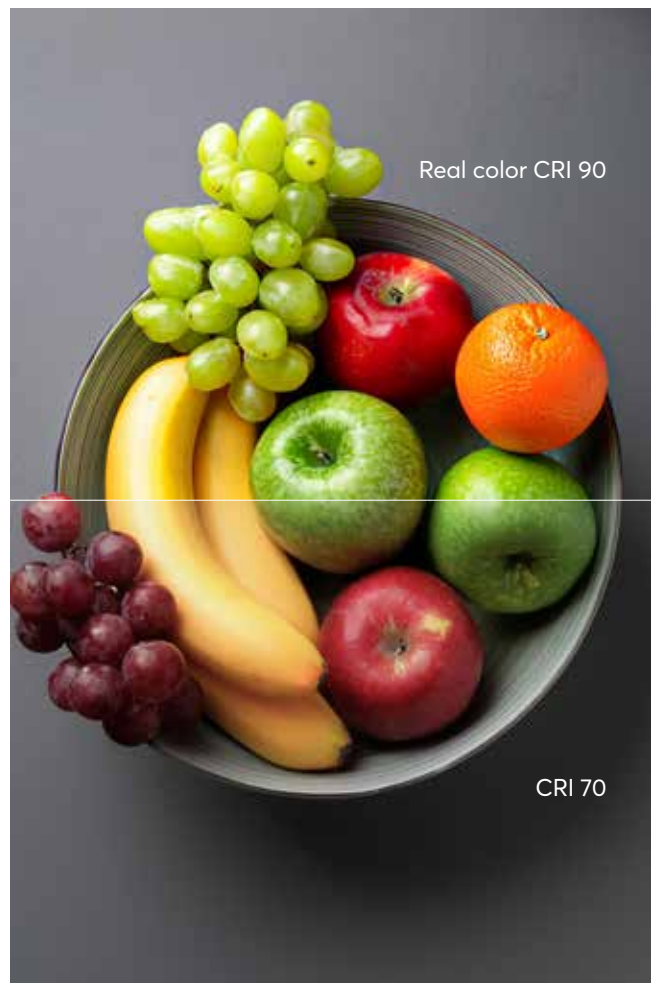

















The CRI value ranges from 0 to 100, with 100 representing perfect color rendering.

A bulb with a CRI of 80 is considered good, but with a CRI of 90 or higher, colors appear even more natural. On the other hand, a CRI below 80 can cause color distortion, making them look yellowish or washed out, and it may even alter the actual shade of objects.







Icons Explanation

Επεξήγηση εικονιδίων

| | | | | | |
|---|--|--|--|--|---|
|  | Beam angle Γωνία δέσμης φωτός |  | Color rendering index Δείκτης χρωματικής απόδοσης |  | Lumen / Watt |
|  | Dimmable Δυνατότητα ρύθμισης φωτεινότητας |  | Non Dimmable Μη δυνατότητα ρύθμισης φωτεινότητας |  | Years of warranty Χρόνια εγγύησης |
|  | Ingress Protection Βαθμός στεγανότητας |  | Life time Διάρκεια ζωής |  | Switches On/Off Ενεργοποίηση-Απενεργοποίηση |
|  | Operating Temperature Θερμοκρασία λειτουργίας |  | Appliance Class Τύπος Μόνωσης Καλωδίων |  | Resistance level Βαθμός αντίστασης |
|  | Flicker Free Δεν τρεμοπαίζει |  | Battery Type Τύπος μπαταρίας |  | Lightning Protection Αντι-κεραυνική προστασία |
|  | Lumen / Chip |  | Cable length Μήκος καλωδίου |  | Sound level Ένταση ήχου |
|  | Test button Δοκιμαστικό κουμπί |  | Self Test Αυτόματος Έλεγχος |  | Sensor Type Τύπος Αισθητήρα |
|  | Συσκευασία από ανακυκλώσιμα υλικά Packaging from recyclable materials | | |  | 10 years shelf life 10 χρόνια διάρκεια ζωής στο ράφι |





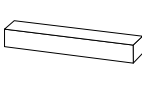





Packaging Icons

Εικονίδια Συσκευασίας

| | | | | | | |
|---|---|---|---|---|---|---|
|  |  |  |  |  |  |  |
| Color Box with eurohole hanger | Color Box with window and eurohole hanger | Blister Packing | Blister with Clamshell & Eurohole | Color Box | Paper Sleeve Packing | Bulk Packing |

Bulbs Bases

Βάσεις λαμπτήρων

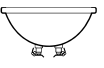
| | | | | | | | | | | | |
|---|---|---|---|---|---|---|---|--|---|---|---|
|  |  |  |  |  |  |  |  |  |  |  |  |
| E27 / E40 | E14 | B22 | GU10 | GU5,3 | G4 | G9 | G5 / G13 | GX53 | G10Q | R7s | PAR56 |

Contents

Περιεχόμενα

| | | | | | |
|---|-----|--|---|-----|--|
|  | 12 | Προωθητική προβολή προϊόντων Promotional Product Displays |  | 175 | Ταινίες LED LED Strips |
|  | 15 | Λαμπτήρες LED Filament LED Filament Lamps |  | 213 | Εξαρτήματα Ταινιών LED LED Strip Accessories |
|  | 28 | Λαμπτήρες LED Κοινής Χρήσης LED Lamps for Common Use |  | 223 | Dimmer, Ενισχυτές Σήματος, Dmx Χειριστήρια Dimmer, Signal Amplifiers, Dmx Controller |
|  | 55 | Λαμπτήρες SMD LED Tube SMD Led Tubes |  | 239 | Τροφοδοτικά Για Ταινίες LED LED Strip Drivers |
|  | 61 | Διακοσμητικοί Λαμπτήρες LED Decor LED Lamps |  | 248 | Προφίλ Αλουμινίου Για Ταινίες LED LED Strip System Profiles |
|  | 69 | Λαμπτήρες Εξειδικευμένης Χρήσης Specialized Use Bulbs |  | 261 | Φωτιστικά LED Γραμμικά Χωνευτά & Εξωτερικά Linear LED Luminaires Recessed & Surface |
|  | 81 | Λαμπτήρες LED SMD Βιομηχανικής & Επαγγελματικής Χρήσης Industrial & Professional Use LED SMD Lamps |  | 290 | Σποτ LED Ράγας & Μαγνητικής Ράγας Track Spot LED Lights & Magnetic Track |
|  | 85 | Λαμπτήρες Φθορίου Fluorescent Lamp Tubes |  | 304 | Μαγνητική Ράγα 48W Magnetic Track 48W |
|  | 95 | Μπαταρίες Batteries |  | 316 | Σποτ LED Ράγας 2 γραμμών Track Spot LED Lights 2 lines |
|  | 103 | Φακοί Flashlights |  | 326 | Σποτ LED Ράγας 4 γραμμών Track Spot LED Lights 4 lines |
|  | 108 | Φωτιστικά LED Πάνελ LED Lighting Panels |  | 346 | Φωτιστικά Πάγκου & Εσωτερικού Χώρου Countertop & Indoor Lights |
|  | 121 | Φωτιστικά Χωνευτά LED SMD & COB LED SMD & COB Recessed Fixtures |  | 356 | Προβολείς LED Εξωτερικού Χώρου Επαγγελματικής Χρήσης Flood LED Lights For Outdoor Professional Use |
|  | 139 | Φωτιστικά LED Εξωτερικά LED Fixtures Surface Mounted |  | 377 | Φωτιστικά Δρόμου LED Street LED Lights |
|  | 147 | Σποτ Χωνευτά Αλουμινίου / Σταθερά / Κινητά / Στεγανά Spot Recessed Aluminum / Fixed / Movable / Waterproof |  | 389 | Καμπάνες LED High Bay LED |
|  | 156 | Γύψινα Φωτιστικά LED Εσωτερικού Χώρου Plaster LED Indoor Lights |  | 395 | Φωτιστικά Πισίνας & Σποτ Συντριβανίου Pool Lights & Fountain Spots |
|  | 167 | Φωτιστικά LED Εφεδρικού Φωτισμού Emergency LED Lighting | | | |

Promotional Product Displays

Πρωθητική προβολή προϊόντων

Η EUROLAMP διαθέτει μια σειρά από ευπαρουσίαστα και λειτουργικά σταντ προϊόντων, κατάλληλα για κάθε επαγγελματικό χώρο. Ιδανικά για να προωθήσουν τα προϊόντα που σας διαθέτουμε. Η προμήθεια τους προϋποθέτει ελάχιστη ποσότητα παραγωγής προϊόντων. Για περισσότερες πληροφορίες παρακαλούμε απευθυνθείτε στον πωλητή που σας εξυπηρετεί.

EUROLAMP has a series of presentable and functional product stands, suitable for any professional space. Ideal to promote the products we have available to you. Their supply requires a minimum order quantity of products. For more information please contact the salesperson serving you.



147-99804
Σταντ Λαμπτήρων
SMD LED
Bulbs Display
→ 53cm
↑ 175cm
↗ 33cm



147-99812
Σταντ Λαμπτήρων
LED FILAMENT
Bulbs Display
→ 53cm
↑ 180cm
↗ 33cm



147-99834
XTREME Batteries
Display / Σταντ
→ 50cm ↑ 170cm ↗ 35cm



147-99835
XTREME Batteries
Tabletop Display
Σταντ Πάγκου
→ 35cm ↑ 58,5cm ↗ 30cm



147-99807
PRODUCTS
STAND
→ 60cm
↑ 85cm
↗ 80cm



147-99833
Σταντ Λαμπτήρων Πάγκου
LED SMD C-CLASS
Bulbs Display
→ 35cm ↑ 55cm ↗ 30cm

147-99831
Σταντ Λαμπτήρων
LED FILAMENT A-CLASS
Bulbs Display
→ 55cm ↑ 180cm ↗ 35cm



147-99843
Σταντ Λαμπτήρων
LED SMD A-CLASS
Pop Up Bulbs Display
→ 40cm
↑ 186cm
↗ 36cm



147-99812
Σταντ Λαμπτήρων
LED SMD C-CLASS
Bulbs Display
→ 55cm ↑ 180cm ↗ 35cm



147-99844
Σταντ Λαμπτήρων
LED FILAMENT C-CLASS
Pop Up Bulbs Display
→ 40cm
↑ 186cm
↗ 36cm

filament

PRO
SERIES

A

τέλειο φως! the perfect light

Γνωρίστε τους νέους λαμπτήρες LED Filament A-class που αλλάζουν τα δεδομένα στην οικονομία! Με ενεργειακή απόδοση 210Lm/W προσδίδουν το ίδιο φως με πολύ λιγότερη κατανάλωση σε σχέση με τους απλούς λαμπτήρες LED. Μοναδική επιλογή για τέλειο φως που θα διαρκέσει ...μια ζωή!

The new LED Filament A-class lamps change the status in energy economy! With an energy efficiency of 210Lm/W, they provide the same light with much less consumption than simple LED lamps.

Unique choice for perfect light that will last ...a lifetime!

*Η ενεργειακή κλάση A αναφέρεται στην πιο πρόσφατη ενεργειακή σήμανση, σύμφωνα με τον κανονισμό της Ευρωπαϊκής Επιτροπής (ΕΕ) 2019/2015
*Energy class A refers to the latest energy labeling, according to Commission delegated regulation (EU) 2019/2015 packaging



**ULTRA
efficient**

210Lm/W
κορυφαία απόδοση
excellent performance

50,000h
40 years
lifetime

60% οικονομία
energy saving

σε σύγκριση με τις κοινές λάμπες LED
comparing with standard SMD LED bulbs

ΕΓΓΥΗΤΗ • GUARANTEE
5
ΧΡΟΝΙΑ • YEARS

και σε νέα
οικολογική
συσκευασία!
new environment
friendly packaging!



Πιστοποιημένα χαρτιά FSC® με προέλευση από υπεύθυνες πηγές.
FSC® certified papers from responsible sources.



Λαμπτήρες
LED Filament

LED Filament
Lamps



filament A-Class A60



E27 Base



Voltage 220-240V 50\60Hz • Lifetime 50.000h • On\Off 50.000
 Cover Διάφανο \ Clear • Starting Time 0.5 sec • Operating Temperature -30° / +45°C
 Υλικό Κατασκευής / Production Material Γυαλί & Βάση Αλουμινίου / Glass & Aluminium Base

| | | | |
|-----------------------------------|----------------------------------|---------------------|-------------------------|
| CRI Ra >80 | BEAM ANGLE 360° | NON DIMMABLE | 5 YEARS WARRANTY |
|-----------------------------------|----------------------------------|---------------------|-------------------------|

| Code | Barcode | Energy Class | Type | Watt | = Watt | Kelvin | Lumen | Dimension Ø (mm) † | Packing | MOQ |
|-----------|---------------|--------------|------|------|--------|--------|-------|--------------------|---------|-----|
| 147-78305 | 5207227276408 | A | A60 | 2.5 | 43 | 4000 | 525 | 60 x 106 | 1/10/50 | 5 |
| 147-78306 | 5207227276415 | A | A60 | 4 | 62 | 4000 | 840 | 60 x 106 | 1/10/50 | 5 |
| 147-78307 | 5207227276422 | A | A60 | 5 | 75 | 4000 | 1055 | 60 x 106 | 1/10/50 | 5 |
| 147-78308 | 5207227276439 | A | A60 | 7.2 | 100 | 4000 | 1521 | 60 x 106 | 1/10/50 | 5 |
| 147-78310 | 5207227276446 | A | A60 | 2.5 | 43 | 3000 | 525 | 60 x 106 | 1/10/50 | 5 |
| 147-78311 | 5207227276453 | A | A60 | 4 | 62 | 3000 | 840 | 60 x 106 | 1/10/50 | 5 |
| 147-78312 | 5207227276460 | A | A60 | 5 | 75 | 3000 | 1055 | 60 x 106 | 1/10/50 | 5 |
| 147-78313 | 5207227276477 | A | A60 | 7.2 | 100 | 3000 | 1521 | 60 x 106 | 1/10/50 | 5 |

CROSS filament A60 / A67



E27 Base



Voltage 220-240V 50\60Hz • Lifetime 25.000h • On\Off 25.000
 Cover Διάφανο \ Clear • Starting Time 0.5 sec • Operating Temperature -30° / +45°C
 Υλικό Κατασκευής / Production Material Γυαλί & Βάση Αλουμινίου / Glass & Aluminium Base

| | | | |
|-----------------------------------|----------------------------------|---------------------|-------------------------|
| CRI Ra >90 | BEAM ANGLE 360° | NON DIMMABLE | 2 YEARS WARRANTY |
|-----------------------------------|----------------------------------|---------------------|-------------------------|

| Code | Barcode | Energy Class | Type | Watt | = Watt | Kelvin | Lumen | Dimension Ø (mm) † | Packing | MOQ |
|-----------|---------------|--------------|------|------|--------|--------|-------|--------------------|---------|-----|
| 147-78001 | 5207227030963 | E | A60 | 4.2 | 40 | 6500 | 480 | 60 x 106 | 1/10/50 | 5 |
| 147-78002 | 5207227030970 | E | A60 | 7 | 60 | 6500 | 806 | 60 x 106 | 1/10/50 | 5 |
| 147-78003 | 5207227037429 | E | A60 | 9 | 75 | 6500 | 1055 | 60 x 106 | 1/10/50 | 5 |
| 147-78005 | 5207227030987 | D | A67 | 11 | 105 | 6500 | 1600 | 67 x 121 | 1/10/50 | 5 |
| 147-78011 | 5207227037436 | E | A60 | 4.2 | 40 | 4000 | 480 | 60 x 106 | 1/10/50 | 5 |
| 147-78012 | 5207227030994 | E | A60 | 7 | 60 | 4000 | 806 | 60 x 106 | 1/10/50 | 5 |
| 147-78013 | 5207227037450 | E | A60 | 9 | 75 | 4000 | 1055 | 60 x 106 | 1/10/50 | 5 |
| 147-78015 | 5207227031007 | D | A67 | 11 | 105 | 4000 | 1600 | 67 x 121 | 1/10/50 | 5 |
| 147-78021 | 5207227031014 | E | A60 | 4.2 | 40 | 2700 | 480 | 60 x 106 | 1/10/50 | 5 |
| 147-78022 | 5207227031021 | E | A60 | 7 | 60 | 2700 | 806 | 60 x 106 | 1/10/50 | 5 |
| 147-78023 | 5207227031038 | E | A60 | 9 | 75 | 2700 | 1055 | 60 x 106 | 1/10/50 | 5 |
| 147-78025 | 5207227031045 | D | A67 | 11 | 105 | 2700 | 1600 | 67 x 121 | 1/10/50 | 5 |
| 147-78031 | 5207227031052 | E | A60 | 4.2 | 40 | 3000 | 480 | 60 x 106 | 1/10/50 | 5 |
| 147-78032 | 5207227031069 | E | A60 | 7 | 60 | 3000 | 806 | 60 x 106 | 1/10/50 | 5 |
| 147-78033 | 5207227031076 | E | A60 | 9 | 75 | 3000 | 1055 | 60 x 106 | 1/10/50 | 5 |
| 147-78035 | 5207227031083 | D | A67 | 11 | 105 | 3000 | 1600 | 67 x 121 | 1/10/50 | 5 |

CROSS
filament **A60 / A67**



E27 Base



Voltage 220-240V 50\60Hz • Lifetime 25.000h • On\Off 25.000
Cover Διάφανο \ Clear • Starting Time 0.5 sec • Operating Temperature -30° / +45°C
Υλικό Κατασκευής / Production Material Γυαλί & Βάση Αλουμινίου / Glass & Aluminium Base

| | | | |
|-------------------------|---------------------------|-----------------|-------------------------------|
| CRI Ra >90 | BEAM ANGLE 360° | DIMMABLE | 2 YEARS WARRANTY |
|-------------------------|---------------------------|-----------------|-------------------------------|

| Code | Barcode | Energy Class | Type | Watt | = Watt | Kelvin | Lumen | Dimension Ø (mm) † | Packing | MOQ |
|-----------|---------------|--------------|------|------|--------|--------|-------|-----------------------|---------|-----|
| 147-78072 | 5207227031137 | E | A60 | 7 | 105 | 3000 | 850 | 60 x 106 | 1/10/50 | 5 |
| 147-78076 | 5207227031915 | E | A60 | 9 | 80 | 3000 | 1100 | 60 x 106 | 1/10/50 | 5 |
| 147-78077 | 5207227056949 | D | A67 | 11 | 105 | 6500 | 1600 | 67 x 121 | 1/10/50 | 5 |
| 147-78078 | 5207227056970 | D | A67 | 11 | 105 | 4000 | 1600 | 67 x 121 | 1/10/50 | 5 |
| 147-78079 | 5207227057007 | D | A67 | 11 | 105 | 3000 | 1600 | 67 x 121 | 1/10/50 | 5 |

CROSS
filament **A60 / A67**



E27 Base



Voltage 220-240V 50\60Hz • Lifetime 25.000h • On\Off 25.000
Cover Διάφανο \ Clear • Starting Time 0.5 sec • Operating Temperature -30° / +45°C
Υλικό Κατασκευής / Production Material Γυαλί & Βάση Αλουμινίου / Glass & Aluminium Base

| | | | |
|-------------------------|---------------------------|---------------------|-------------------------------|
| CRI Ra >90 | BEAM ANGLE 360° | NON DIMMABLE | 2 YEARS WARRANTY |
|-------------------------|---------------------------|---------------------|-------------------------------|

| Code | Barcode | Energy Class | Type | Watt | = Watt | Kelvin | Lumen | Dimension Ø (mm) † | Packing | MOQ |
|-----------|---------------|--------------|------|------|--------|--------|-------|-----------------------|---------|-----|
| 147-79011 | 5207227139123 | F | A60 | 4.5 | 40 | 2700 | 480 | 60 x 106 | 1/10/50 | 10 |
| 147-79012 | 5207227139154 | E | A60 | 7 | 60 | 2700 | 806 | 60 x 106 | 1/10/50 | 10 |



CROSS
filament **A60 Milky**



E27 Base



Voltage 220-240V 50\60Hz • Lifetime 25.000h • On\Off 25.000

Cover Γαλακτούχα / Milky • Starting Time 0.5 sec • Operating Temperature -30° / +45°C

Υλικό Κατασκευής / Production Material Γυαλί & Βάση Αλουμινίου / Glass & Aluminium Base

| Code | Barcode | Energy Class | Type | Watt | = Watt | Kelvin | Lumen | Dimension Ø (mm) † | Packing | MOQ |
|-----------|---------------|--------------|------|------|--------|--------|-------|--------------------|---------|-----|
| 147-78413 | 5207227429187 | E | A60 | 4.2 | 40 | 6500 | 480 | 60 x 106 | 1/10/50 | 5 |
| 147-78414 | 5207227429286 | E | A60 | 7 | 66 | 6500 | 900 | 60 x 106 | 1/10/50 | 5 |
| 147-78415 | 5207227429385 | E | A60 | 9 | 72 | 6500 | 1055 | 60 x 106 | 1/10/50 | 5 |
| 147-78416 | 5207227429484 | D | A60 | 11 | 100 | 6500 | 1600 | 60 x 106 | 1/10/50 | 5 |
| 147-78423 | 5207227429217 | E | A60 | 4.2 | 40 | 4000 | 480 | 60 x 106 | 1/10/50 | 5 |
| 147-78424 | 5207227429316 | E | A60 | 7 | 66 | 4000 | 900 | 60 x 106 | 1/10/50 | 5 |
| 147-78425 | 5207227429415 | E | A60 | 9 | 72 | 4000 | 1055 | 60 x 106 | 1/10/50 | 5 |
| 147-78426 | 5207227429514 | D | A60 | 11 | 100 | 4000 | 1600 | 60 x 106 | 1/10/50 | 5 |
| 147-78433 | 5207227429248 | E | A60 | 4.2 | 40 | 3000 | 480 | 60 x 106 | 1/10/50 | 5 |
| 147-78434 | 5207227429347 | E | A60 | 7 | 66 | 3000 | 900 | 60 x 106 | 1/10/50 | 5 |
| 147-78435 | 5207227429446 | E | A60 | 9 | 72 | 3000 | 1055 | 60 x 106 | 1/10/50 | 5 |
| 147-78436 | 5207227429545 | D | A60 | 11 | 100 | 3000 | 1600 | 60 x 106 | 1/10/50 | 5 |



| Code | Barcode | Energy Class | Type | Watt | = Watt | Kelvin | Lumen | Dimension Ø (mm) † | Packing | MOQ |
|-----------|---------------|--------------|------|------|--------|--------|-------|--------------------|---------|-----|
| 147-78474 | 5207227429590 | D | A60 | 11 | 100 | 4000 | 1600 | 60 x 106 | 1/10/50 | 5 |
| 147-78475 | 5207227429620 | D | A60 | 11 | 100 | 3000 | 1600 | 60 x 106 | 1/10/50 | 5 |



CROSS
filament **A60 / A67**



B22 Base



Voltage 220-240V 50\60Hz • Lifetime 25.000h • On\Off 25.000

Cover Διάφανο \ Clear • Starting Time 0.5 sec • Operating Temperature -30° / +45°C

Υλικό Κατασκευής / Production Material Γυαλί & Βάση Αλουμινίου / Glass & Aluminium Base

| | | | |
|-----------------------------------|----------------------------------|---------------------|-------------------------------|
| CRI Ra >90 | BEAM ANGLE 360° | NON DIMMABLE | 2 YEARS WARRANTY |
|-----------------------------------|----------------------------------|---------------------|-------------------------------|

| Code | Barcode | Energy Class | Type | Watt | = Watt | Kelvin | Lumen | Dimension Ø (mm) † | Packing | MOQ |
|------------------|---------------|--------------|------|------|--------|--------|-------|-----------------------|---------|-----|
| 147-78042 | 5207227031090 | E | A60 | 9 | 75 | 6500 | 1055 | 60 x 106 | 1/10/50 | 5 |
| 147-78043 | 5207227031106 | D | A67 | 11 | 105 | 6500 | 1600 | 67 x 121 | 1/10/50 | 5 |
| 147-78062 | 5207227031113 | E | A60 | 9 | 75 | 3000 | 1055 | 60 x 106 | 1/10/50 | 5 |
| 147-78063 | 5207227031120 | D | A67 | 11 | 105 | 3000 | 1600 | 67 x 121 | 1/10/50 | 5 |



| Code | Barcode | Energy Class | Type | Watt | = Watt | Kelvin | Lumen | Dimension Ø (mm) † | Packing | MOQ |
|------------------|---------------|--------------|------|------|--------|--------|-------|-----------------------|---------|-----|
| 147-78047 | 5207227117305 | D | A67 | 11 | 105 | 6500 | 1600 | 67 x 121 | 1/10/50 | 5 |
| 147-78067 | 5207227117336 | D | A67 | 11 | 105 | 3000 | 1600 | 67 x 121 | 1/10/50 | 5 |





filament A-Class C35



E14 Base



Voltage 220-240V 50\60Hz • Lifetime 50.000h • On/Off 50.000
 Cover Διάφανο \ Clear • Starting Time 0.5 sec • Operating Temperature -30° / +45°C
 Υλικό Κατασκευής / Production Material Γυαλί & Βάση Αλουμινίου / Glass & Aluminium Base

| | | | |
|-----------------------------------|----------------------------------|---------------------|----------------------------|
| CRI Ra >80 | BEAM ANGLE 360° | NON DIMMABLE | 5 YEARS WARRANTY |
|-----------------------------------|----------------------------------|---------------------|----------------------------|

| Code | Barcode | Energy Class | Type | Watt | = Watt | Kelvin | Lumen | Dimension Ø (mm) ↓ | Packing | MOQ |
|-----------|---------------|--------------|------|------|--------|--------|-------|--------------------|---------|-----|
| 147-78324 | 5207227276484 | A | C35 | 2.5 | 43 | 4000 | 525 | 35 x 120 | 1/10/50 | 5 |
| 147-78327 | 5207227276491 | A | C35 | 2.5 | 43 | 3000 | 525 | 35 x 120 | 1/10/50 | 5 |



CROSS filament C37



E14 Base



Voltage 220-240V 50\60Hz • Lifetime 25.000h • On/Off 25.000
 Cover Διάφανο \ Clear • Starting Time 0.5 sec • Operating Temperature -30° / +45°C
 Υλικό Κατασκευής / Production Material Γυαλί & Βάση Αλουμινίου / Glass & Aluminium Base

| | | | |
|-----------------------------------|----------------------------------|---------------------|----------------------------|
| CRI Ra >90 | BEAM ANGLE 360° | NON DIMMABLE | 2 YEARS WARRANTY |
|-----------------------------------|----------------------------------|---------------------|----------------------------|

| Code | Barcode | Energy Class | Type | Watt | = Watt | Kelvin | Lumen | Dimension Ø (mm) ↓ | Packing | MOQ |
|-----------|---------------|--------------|------|------|--------|--------|-------|--------------------|---------|-----|
| 147-78100 | 5207227036187 | E | C37 | 2.2 | 25 | 6500 | 250 | 35 x 98 | 1/10/50 | 5 |
| 147-78101 | 5207227036194 | E | C37 | 4.2 | 40 | 6500 | 480 | 35 x 98 | 1/10/50 | 5 |
| 147-78102 | 5207227036200 | E | C37 | 6.5 | 60 | 6500 | 806 | 35 x 98 | 1/10/50 | 5 |
| 147-78110 | 5207227036231 | E | C37 | 2.2 | 25 | 4000 | 250 | 35 x 98 | 1/10/50 | 5 |
| 147-78111 | 5207227036248 | E | C37 | 4.2 | 40 | 4000 | 480 | 35 x 98 | 1/10/50 | 5 |
| 147-78112 | 5207227036255 | E | C37 | 6.5 | 60 | 4000 | 806 | 35 x 98 | 1/10/50 | 5 |
| 147-78120 | 5207227036286 | E | C37 | 2.2 | 25 | 3000 | 250 | 35 x 98 | 1/10/50 | 5 |
| 147-78121 | 5207227036293 | E | C37 | 4.2 | 40 | 3000 | 480 | 35 x 98 | 1/10/50 | 5 |
| 147-78122 | 5207227036309 | E | C37 | 6.5 | 60 | 3000 | 806 | 35 x 98 | 1/10/50 | 5 |
| 147-78130 | 5207227036330 | E | C37 | 2.2 | 25 | 2700 | 250 | 35 x 98 | 1/10/50 | 5 |
| 147-78131 | 5207227036347 | E | C37 | 4.2 | 40 | 2700 | 480 | 35 x 98 | 1/10/50 | 5 |
| 147-78132 | 5207227036354 | E | C37 | 6.5 | 60 | 2700 | 806 | 35 x 98 | 1/10/50 | 5 |



| Code | Barcode | Energy Class | Type | Watt | = Watt | Kelvin | Lumen | Dimension Ø (mm) ↓ | Packing | MOQ |
|-----------|---------------|--------------|------|------|--------|--------|-------|--------------------|---------|-----|
| 147-78173 | 5207227036408 | E | C37 | 6.5 | 60 | 3000 | 806 | 35 x 98 | 1/10/50 | 5 |
| 147-78183 | 5207227143298 | E | C37 | 6.5 | 60 | 2700 | 806 | 35 x 98 | 1/10/50 | 5 |

CROSS
filament **C37**



Voltage 220-240V 50\60Hz • Lifetime 25.000h • On\Off 25.000
Cover Διάφανο \ Clear • Starting Time 0.5 sec • Operating Temperature -30° / +45°C
Υλικό Κατασκευής / Production Material Γυαλί & Βάση Αλουμινίου / Glass & Aluminium Base

| Code | Barcode | Energy Class | Type | Watt | = Watt | Kelvin | Lumen | Dimension Ø (mm) † | Packing | MOQ |
|-----------|---------------|--------------|------|------|--------|--------|-------|-----------------------|---------|-----|
| 147-79103 | 5207227109225 | | C37 | 6.5 | 60 | 6500 | 806 | 35 x 98 | 1/10/50 | 5 |
| 147-79111 | 5207227140693 | | C37 | 4.5 | 40 | 2700 | 480 | 35 x 98 | 1/10/50 | 5 |

CROSS
filament **C35 Milky**



Voltage 220-240V 50\60Hz • Lifetime 25.000h • On\Off 25.000
Cover Γαλακτούχα / Milky • Starting Time 0.5 sec • Operating Temperature -30° / +45°C
Υλικό Κατασκευής / Production Material Γυαλί & Βάση Αλουμινίου / Glass & Aluminium Base

| Code | Barcode | Energy Class | Type | Watt | = Watt | Kelvin | Lumen | Dimension Ø (mm) † | Packing | MOQ |
|-----------|---------------|--------------|------|------|--------|--------|-------|-----------------------|---------|-----|
| 147-78140 | 5207227429651 | | C35 | 4.2 | 40 | 6500 | 480 | 35 x 98 | 1/10/50 | 5 |
| 147-78141 | 5207227429750 | | C35 | 6.5 | 55 | 6500 | 806 | 35 x 98 | 1/10/50 | 5 |
| 147-78150 | 5207227429682 | | C35 | 4.2 | 40 | 4000 | 480 | 35 x 98 | 1/10/50 | 5 |
| 147-78151 | 5207227429781 | | C35 | 6.5 | 55 | 4000 | 806 | 35 x 98 | 1/10/50 | 5 |
| 147-78160 | 5207227429712 | | C35 | 4.2 | 40 | 3000 | 480 | 35 x 98 | 1/10/50 | 5 |
| 147-78161 | 5207227429811 | | C35 | 6.5 | 55 | 3000 | 806 | 35 x 98 | 1/10/50 | 5 |

CROSS filament C37 Frost



E14 Base



Voltage 220-240V 50\60Hz • Lifetime 25.000h • On\Off 25.000
 Cover Ημιδιάφανο / Frost • Starting Time 0.5 sec • Operating Temperature -30° / +45°C
 Υλικό Κατασκευής / Production Material Γυαλί & Βάση Αλουμινίου / Glass & Aluminium Base

CRI **Ra >90** BEAM ANGLE **360°** **NON DIMMABLE** **2 YEARS WARRANTY**

| Code | Barcode | Energy Class | Type | Watt | = Watt | Kelvin | Lumen | Dimension Ø (mm) † | Packing | MOQ |
|-----------|---------------|--------------|------|------|--------|--------|-------|--------------------|---------|-----|
| 147-78104 | 5207227036217 | F | C37 | 4.5 | 40 | 6500 | 480 | 35 x 98 | 1/10/50 | 5 |
| 147-78105 | 5207227036224 | E | C37 | 6.5 | 60 | 6500 | 806 | 35 x 98 | 1/10/50 | 5 |



| Code | Barcode | Energy Class | Type | Watt | = Watt | Kelvin | Lumen | Dimension Ø (mm) † | Packing | MOQ |
|-----------|---------------|--------------|------|------|--------|--------|-------|--------------------|---------|-----|
| 147-78152 | 5207227055812 | F | C37 | 4.5 | 40 | 6500 | 480 | 35 x 98 | 1/10/50 | 5 |
| 147-78154 | 5207227064180 | E | C37 | 6.5 | 60 | 6500 | 806 | 35 x 98 | 1/10/50 | 5 |
| 147-78162 | 5207227055829 | E | C37 | 4.2 | 40 | 4000 | 480 | 35 x 98 | 1/10/50 | 5 |
| 147-78172 | 5207227036392 | E | C37 | 4.2 | 40 | 3000 | 480 | 35 x 98 | 1/10/50 | 5 |



CROSS filament F37 Long Tip



E14 Base



Voltage 220-240V 50\60Hz • Lifetime 25.000h • On\Off 25.000
 Cover Διάφανο / Clear • Starting Time 0.5 sec • Operating Temperature -30° / +45°C
 Υλικό Κατασκευής / Production Material Γυαλί & Βάση Αλουμινίου / Glass & Aluminium Base

CRI **Ra >90** BEAM ANGLE **360°** **DIMMABLE** **2 YEARS WARRANTY**

| Code | Barcode | Energy Class | Type | Watt | = Watt | Kelvin | Lumen | Dimension Ø (mm) † | Packing | MOQ |
|-----------|---------------|--------------|------|------|--------|--------|-------|--------------------|---------|-----|
| 147-78176 | 5207227073892 | E | F37 | 4.2 | 40 | 2700 | 480 | 35 x 119 | 1/10/50 | 5 |



filament T25



E14 Base



Voltage 220-240V 50\60Hz • Lifetime 25.000h • On\Off 25.000
 Cover Διάφανο / Clear • Starting Time 0.5 sec • Operating Temperature -30° / +45°C
 Υλικό Κατασκευής / Production Material Γυαλί & Βάση Αλουμινίου / Glass & Aluminium Base

CRI **Ra >80** BEAM ANGLE **360°** **NON DIMMABLE** **2 YEARS WARRANTY**

| Code | Barcode | Energy Class | Type | Watt | = Watt | Kelvin | Lumen | Dimension Ø (mm) † | Packing | MOQ |
|-----------|---------------|--------------|------|------|--------|--------|-------|--------------------|---------|-----|
| 147-78492 | 5207227276620 | E | T25 | 2.2 | 25 | 3000 | 250 | 25 x 83 | 1/10/50 | 10 |
| 147-78497 | 5207227276637 | E | T25 | 4.2 | 40 | 3000 | 470 | 25 x 83 | 1/10/50 | 10 |

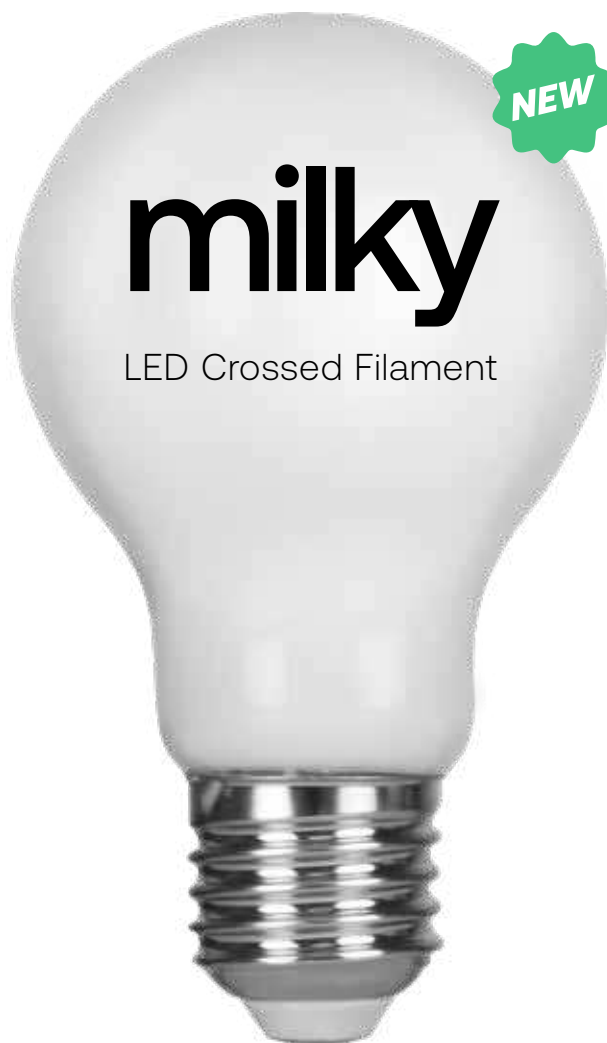

Ομοιόμορφο φως,
ξεκούραστη ατμόσφαιρα!
Even light, relaxing atmosphere!

Οι LED Milky λαμπτήρες της EUROLAMP προσφέρουν ισομερή διάχυση φωτός, μειώνοντας τη θαμπάδα και την κόπωση των ματιών. Ιδανικοί για ζεστή και χαλαρωτική ατμόσφαιρα, με απόδοση 110 lm/W.

EUROLAMP LED Milky bulbs provide uniform light distribution, reducing glare and eye strain. Ideal for a warm and calming ambiance, with an efficiency of 110 lm/W.

ομοιόμορφη
διάχυση φωτός
uniform light distribution

μειώνει τη θαμπάδα
και την κόπωση των ματιών
reduces glare and eye strain

δημιουργεί
πιο ήρεμη ατμόσφαιρα
creates a more relaxing atmosphere

110 lm/W
υψηλή απόδοση
high efficiency

EUROLAMP®

CROSS
filament **G45**



E14 Base



Voltage 220-240V 50\60Hz • Lifetime 25.000h • On\Off 25.000
Cover Διάφανο / Clear • Starting Time 0.5 sec • Operating Temperature -30° / +45°C
Υλικό Κατασκευής / Production Material Γυαλί & Βάση Αλουμινίου / Glass & Aluminium Base

| Code | Barcode | Energy Class | Type | Watt | = Watt | Kelvin | Lumen | Dimension Ø (mm) † | Packing | MOQ |
|-----------|---------------|--------------|------|------|--------|--------|-------|--------------------|---------|-----|
| 147-78211 | 5207227036439 | E | G45 | 4.2 | 40 | 4000 | 480 | 45 x 78 | 1/10/50 | 5 |
| 147-78212 | 5207227036446 | E | G45 | 6.5 | 60 | 4000 | 806 | 45 x 78 | 1/10/50 | 5 |
| 147-78221 | 5207227036460 | E | G45 | 4.2 | 40 | 3000 | 480 | 45 x 78 | 1/10/50 | 5 |
| 147-78222 | 5207227036477 | E | G45 | 6.5 | 60 | 3000 | 806 | 45 x 78 | 1/10/50 | 5 |
| 147-78231 | 5207227036507 | E | G45 | 4.2 | 40 | 2700 | 480 | 45 x 78 | 1/10/50 | 5 |
| 147-78232 | 5207227036514 | E | G45 | 6.5 | 60 | 2700 | 806 | 45 x 78 | 1/10/50 | 5 |



| Code | Barcode | Energy Class | Type | Watt | = Watt | Kelvin | Lumen | Dimension Ø (mm) † | Packing | MOQ |
|-----------|---------------|--------------|------|------|--------|--------|-------|--------------------|---------|-----|
| 147-78272 | 5207227036590 | E | G45 | 6.5 | 60 | 3000 | 806 | 45 x 74 | 1/10/50 | 5 |

CROSS
filament **G45**



E27 Base



Voltage 220-240V 50\60Hz • Lifetime 25.000h • On\Off 25.000
Cover Διάφανο / Clear • Starting Time 0.5 sec • Operating Temperature -30° / +45°C
Υλικό Κατασκευής / Production Material Γυαλί & Βάση Αλουμινίου / Glass & Aluminium Base

| Code | Barcode | Energy Class | Type | Watt | = Watt | Kelvin | Lumen | Dimension Ø (mm) † | Packing | MOQ |
|-----------|---------------|--------------|------|------|--------|--------|-------|--------------------|---------|-----|
| 147-78251 | 5207227036545 | E | G45 | 4.2 | 40 | 4000 | 480 | 45 x 74 | 1/10/50 | 5 |
| 147-78252 | 5207227036552 | E | G45 | 6.5 | 60 | 4000 | 806 | 45 x 74 | 1/10/50 | 5 |
| 147-78260 | 5207227064258 | F | G45 | 2.5 | 25 | 3000 | 250 | 45 x 74 | 1/10/50 | 5 |
| 147-78261 | 5207227036569 | E | G45 | 4.2 | 40 | 3000 | 480 | 45 x 74 | 1/10/50 | 5 |
| 147-78262 | 5207227036576 | E | G45 | 6.5 | 60 | 3000 | 806 | 45 x 74 | 1/10/50 | 5 |
| 147-78291 | 5207227117367 | E | G45 | 4.2 | 40 | 2700 | 480 | 45 x 74 | 1/10/50 | 5 |
| 147-78292 | 5207227117381 | E | G45 | 6.5 | 60 | 2700 | 806 | 45 x 74 | 1/10/50 | 5 |



| Code | Barcode | Energy Class | Type | Watt | = Watt | Kelvin | Lumen | Dimension Ø (mm) † | Packing | MOQ |
|-----------|---------------|--------------|------|------|--------|--------|-------|--------------------|---------|-----|
| 147-78282 | 5207227036606 | E | G45 | 6.5 | 60 | 3000 | 806 | 45 x 74 | 1/10/50 | 5 |

Λαμπτήρες για γιρλάντες φωτισμού
Bulbs for lighting garlands



filament **G45**

Voltage 220-240V 50\60Hz • Lifetime 25.000h • On\Off 25.000
Cover Διάφανο / Clear • Starting Time 0.5 sec • Operating Temperature -30° / +45°C
Υλικό Κατασκευής / Production Material Γυαλί & Βάση Αλουμινίου / Glass & Aluminium Base

| Code | Barcode | Energy Class | Type | Watt | = Watt | Kelvin | Lumen | Dimension Ø (mm) ↓ | Packing | MOQ |
|-----------|---------------|--------------|------|------|--------|--------|-------|-----------------------|---------|-----|
| 147-78253 | 5207227276644 | F | G45 | 1 | 10 | 4000 | 90 | 45 x 70 | 1/10/50 | 10 |
| 147-78263 | 5207227276668 | F | G45 | 1 | 10 | 3000 | 90 | 45 x 70 | 1/10/50 | 10 |

Λαμπτήρες για γιρλάντες φωτισμού
Bulbs for lighting garlands



filament **G45**

Voltage 220-240V 50\60Hz • Lifetime 25.000h • On\Off 25.000
Cover Διάφανο / Clear • Starting Time 0.5 sec • Operating Temperature -30° / +45°C
Υλικό Κατασκευής / Production Material Γυαλί & Βάση Αλουμινίου / Glass & Aluminium Base

| Code | Barcode | Energy Class | Type | Watt | = Watt | Kelvin | Lumen | Dimension Ø (mm) ↓ | Packing | MOQ |
|-----------|---------------|--------------|------|------|--------|--------|-------|-----------------------|---------|-----|
| 147-78268 | 5207227276675 | F | G45 | 1 | 10 | 3000 | 90 | 45 x 70 | 1/10/50 | 10 |





filament A-Class G95 / G125



E27 Base



Voltage 220-240V 50\60Hz • Lifetime 50.000h • On\Off 50.000
Cover Διάφανο / Clear • Starting Time 0.5 sec • Operating Temperature -30° / +45°C
Υλικό Κατασκευής / Production Material Γυαλί & Βάση Αλουμινίου / Glass & Aluminium Base

CRI **Ra >80** BEAM ANGLE **360°** NON DIMMABLE **5 YEARS WARRANTY**

| Code | Barcode | Energy Class | Type | Watt | = Watt | Kelvin | Lumen | Dimension Ø (mm) † | Packing | MOQ |
|-----------|---------------|--------------|------|------|--------|--------|-------|--------------------|---------|-----|
| 147-78366 | 5207227276545 | A | G95 | 4 | 62 | 4000 | 840 | 95 x 140 | 1/5/20 | 5 |
| 147-78368 | 5207227276552 | A | G95 | 7.2 | 100 | 4000 | 1521 | 95 x 140 | 1/5/20 | 5 |
| 147-78371 | 5207227276569 | A | G95 | 4 | 62 | 3000 | 840 | 95 x 140 | 1/5/20 | 5 |
| 147-78373 | 5207227276576 | A | G95 | 7.2 | 100 | 3000 | 1521 | 95 x 140 | 1/5/20 | 5 |
| 147-78388 | 5207227276590 | A | G125 | 7.2 | 100 | 4000 | 1521 | 125 x 178 | 1/5/20 | 5 |
| 147-78393 | 5207227276613 | A | G125 | 7.2 | 100 | 3000 | 1521 | 125 x 178 | 1/5/20 | 5 |

CROSS filament G95 / G125



E27 Base



Voltage 220-240V 50\60Hz • Lifetime 25.000h • On\Off 25.000
Cover Διάφανο / Clear • Starting Time 0.5 sec • Operating Temperature -30° / +45°C
Υλικό Κατασκευής / Production Material Γυαλί & Βάση Αλουμινίου / Glass & Aluminium Base

CRI **Ra >90** BEAM ANGLE **360°** NON DIMMABLE **2 YEARS WARRANTY**

| Code | Barcode | Energy Class | Type | Watt | = Watt | Kelvin | Lumen | Dimension Ø (mm) † | Packing | MOQ |
|-----------|---------------|--------------|------|------|--------|--------|-------|--------------------|---------|-----|
| 147-78421 | 5207227036637 | E | G95 | 8 | 75 | 3000 | 1055 | 95 x 142 | 1/5/20 | 5 |
| 147-78422 | 5207227036644 | D | G95 | 11 | 105 | 3000 | 1600 | 95 x 142 | 1/5/20 | 5 |
| 147-78451 | 5207227036675 | E | G125 | 8 | 75 | 3000 | 1055 | 125 x 180 | 1/5/20 | 5 |
| 147-78452 | 5207227036682 | D | G125 | 11 | 105 | 3000 | 1600 | 125 x 180 | 1/5/20 | 5 |



| Code | Barcode | Energy Class | Type | Watt | = Watt | Kelvin | Lumen | Dimension Ø (mm) † | Packing | MOQ |
|-----------|---------------|--------------|------|------|--------|--------|-------|--------------------|---------|-----|
| 147-78460 | 5207227055836 | D | G95 | 11 | 105 | 6500 | 1600 | 95 x 142 | 1/5/20 | 5 |
| 147-78461 | 5207227036699 | D | G95 | 11 | 105 | 4000 | 1600 | 95 x 142 | 1/5/20 | 5 |
| 147-78471 | 5207227036712 | D | G95 | 11 | 105 | 3000 | 1600 | 95 x 142 | 1/5/20 | 5 |
| 147-78472 | 5207227036729 | D | G125 | 11 | 105 | 3000 | 1600 | 125 x 180 | 1/5/20 | 5 |

CROSS
filament

G95 / G125



E27 Base



Voltage 220-240V 50\60Hz • Lifetime 25.000h • On\Off 25.000
Cover Γαλακτούχα / Milky • Starting Time 0.5 sec • Operating Temperature -30° / +45°C
Υλικό Κατασκευής / Production Material Γυαλί & Βάση Αλουμινίου / Glass & Aluminium Base

| | | | |
|-------------------------|---------------------------|-----------------|-------------------------------|
| CRI Ra >90 | BEAM ANGLE 360° | NON DIMMABLE | 2 YEARS WARRANTY |
|-------------------------|---------------------------|-----------------|-------------------------------|

| Code | Barcode | Energy Class | Type | Watt | = Watt | Kelvin | Lumen | Dimension Ø (mm) † | Packing | MOQ |
|-----------|---------------|--------------|------|------|--------|--------|-------|-----------------------|---------|-----|
| 147-78411 | 5207227036613 | D | G95 | 7.8 | 75 | 4000 | 1055 | 95 x 142 | 1/5/20 | 5 |
| 147-78441 | 5207227036651 | E | G125 | 8 | 75 | 4000 | 1055 | 125 x 180 | 1/5/20 | 5 |



filament
A-Class **ST64**



E27 Base



Voltage 220-240V 50\60Hz • Lifetime 50.000h • On\Off 50.000
Cover Διάφανο / Clear • Starting Time 0.5 sec • Operating Temperature -30° / +45°C
Υλικό Κατασκευής / Production Material Γυαλί & Βάση Αλουμινίου / Glass & Aluminium Base

| | | | |
|-------------------------|---------------------------|-----------------|-------------------------------|
| CRI Ra >80 | BEAM ANGLE 360° | NON DIMMABLE | 5 YEARS WARRANTY |
|-------------------------|---------------------------|-----------------|-------------------------------|

| Code | Barcode | Energy Class | Type | Watt | = Watt | Kelvin | Lumen | Dimension Ø (mm) † | Packing | MOQ |
|-----------|---------------|--------------|------|------|--------|--------|-------|-----------------------|---------|-----|
| 147-78346 | 5207227276507 | A | ST64 | 4 | 62 | 4000 | 840 | 64 x 140 | 1/10/50 | 5 |
| 147-78351 | 5207227276521 | A | ST64 | 4 | 62 | 3000 | 840 | 64 x 140 | 1/10/50 | 5 |

CROSS
filament

ST64



E27 Base



Voltage 220-240V 50\60Hz • Lifetime 25.000h • On\Off 25.000
Cover Διάφανο / Clear • Starting Time 0.5 sec • Operating Temperature -30° / +45°C
Υλικό Κατασκευής / Production Material Γυαλί & Βάση Αλουμινίου / Glass & Aluminium Base

| | | | |
|-------------------------|---------------------------|----------|-------------------------------|
| CRI Ra >90 | BEAM ANGLE 360° | DIMMABLE | 2 YEARS WARRANTY |
|-------------------------|---------------------------|----------|-------------------------------|

| Code | Barcode | Energy Class | Type | Watt | = Watt | Kelvin | Lumen | Dimension Ø (mm) † | Packing | MOQ |
|-----------|---------------|--------------|------|------|--------|--------|-------|-----------------------|---------|-----|
| 147-78480 | 5207227057038 | D | ST64 | 11 | 105 | 6500 | 1600 | 64 x 140 | 1/10/50 | 5 |
| 147-78481 | 5207227057069 | D | ST64 | 11 | 105 | 4000 | 1600 | 64 x 140 | 1/10/50 | 5 |
| 147-78482 | 5207227036736 | D | ST64 | 11 | 105 | 3000 | 1600 | 64 x 140 | 1/10/50 | 5 |





Λαμπτήρες LED
Κοινής Χρήσης

LED Lamps
for Common Use

SMD
2835 A60



E27 Base



Voltage 175-265V 50\60Hz • Lifetime 40.000h • On\Off 50.000
Cover Ημιδιάφανο / Frost • Starting Time 0.5 sec • Operating Temperature -30° / +45°C
Υλικό / Material Πλαστικό με Ψύκτρα Αλουμινίου/ Plastic with Aluminium Heatsink

| | | | |
|-------------------------|---------------------------|---------------------|-------------------------|
| CRI Ra >80 | BEAM ANGLE 230° | NON DIMMABLE | 5 YEARS WARRANTY |
|-------------------------|---------------------------|---------------------|-------------------------|

| Code | Barcode | Energy Class | Type | Watt | = Watt | Kelvin | Lumen | Dimension Ø (mm) † | Packing | MOQ |
|-----------|---------------|--------------|------|------|--------|--------|-------|-----------------------|---------|-----|
| 147-77110 | 5207227174704 | C | A60 | 2.9 | 40 | 6500 | 470 | 60 x 108 | 1\10\50 | 10 |
| 147-77111 | 5207227174711 | C | A60 | 5 | 60 | 6500 | 806 | 60 x 108 | 1\10\50 | 10 |
| 147-77112 | 5207227174728 | C | A60 | 6.5 | 75 | 6500 | 1055 | 60 x 108 | 1\10\50 | 10 |
| 147-77113 | 5207227174735 | C | A60 | 9.5 | 100 | 6500 | 1521 | 60 x 112 | 1\10\50 | 10 |
| 147-77120 | 5207227174759 | C | A60 | 2.9 | 40 | 4000 | 470 | 60 x 108 | 1\10\50 | 10 |
| 147-77121 | 5207227174766 | C | A60 | 5 | 60 | 4000 | 806 | 60 x 108 | 1\10\50 | 10 |
| 147-77122 | 5207227174773 | C | A60 | 6.5 | 75 | 4000 | 1055 | 60 x 108 | 1\10\50 | 10 |
| 147-77123 | 5207227174780 | C | A60 | 9.5 | 100 | 4000 | 1521 | 60 x 112 | 1\10\50 | 10 |
| 147-77130 | 5207227174803 | C | A60 | 2.9 | 40 | 3000 | 470 | 60 x 108 | 1\10\50 | 10 |
| 147-77131 | 5207227174810 | C | A60 | 5 | 60 | 3000 | 806 | 60 x 108 | 1\10\50 | 10 |
| 147-77132 | 5207227174827 | C | A60 | 6.5 | 75 | 3000 | 1055 | 60 x 108 | 1\10\50 | 10 |
| 147-77133 | 5207227174834 | C | A60 | 9.5 | 100 | 3000 | 1521 | 60 x 112 | 1\10\50 | 10 |



SMD
2835 A60



Voltage 175-250V 50\60Hz • Lifetime 25.000h • On\Off 25.000
Cover Ημιδιάφανο / Frost • Starting Time 0.5 sec • Operating Temperature -30° / +45°C
Υλικό / Material Πλαστικό με Ψύκτρα Αλουμινίου/ Plastic with Aluminium Heatsink

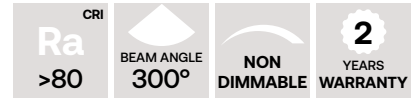

| Code | Barcode | Energy Class | Type | Watt | = Watt | Kelvin | Lumen | Dimension Ø (mm) † | Packing | MOQ |
|-----------|---------------|--------------|------|------|--------|--------|-------|--------------------|---------|-----|
| 147-77000 | 5207227112560 | F | A60 | 4.9 | 40 | 6500 | 480 | 60 x 107 | 1\10\50 | 10 |
| 147-77001 | 5207227112591 | F | A60 | 7 | 50 | 6500 | 650 | 60 x 107 | 1\10\50 | 10 |
| 147-77002 | 5207227112621 | F | A60 | 8.8 | 60 | 6500 | 810 | 60 x 108 | 1\10\50 | 10 |
| 147-77003 | 5207227112652 | F | A60 | 11.1 | 75 | 6500 | 1055 | 60 x 112 | 1\10\50 | 10 |
| 147-77004 | 5207227112683 | F | A60 | 15 | 105 | 6500 | 1521 | 60 x 124 | 1\10\50 | 10 |
| 147-77010 | 5207227112867 | F | A60 | 4.9 | 40 | 4000 | 480 | 60 x 107 | 1\10\50 | 10 |
| 147-77011 | 5207227112898 | F | A60 | 7 | 50 | 4000 | 650 | 60 x 107 | 1\10\50 | 10 |
| 147-77012 | 5207227112928 | F | A60 | 8.8 | 60 | 4000 | 810 | 60 x 108 | 1\10\50 | 10 |
| 147-77013 | 5207227112959 | F | A60 | 11.1 | 75 | 4000 | 1055 | 60 x 112 | 1\10\50 | 10 |
| 147-77014 | 5207227112980 | F | A60 | 15 | 105 | 4000 | 1521 | 60 x 124 | 1\10\50 | 10 |
| 147-77020 | 5207227263484 | F | A60 | 4.9 | 40 | 3000 | 480 | 60 x 107 | 1\10\50 | 10 |
| 147-77021 | 5207227263514 | F | A60 | 7 | 50 | 3000 | 650 | 60 x 107 | 1\10\50 | 10 |
| 147-77022 | 5207227263545 | F | A60 | 8.8 | 60 | 3000 | 810 | 60 x 108 | 1\10\50 | 10 |
| 147-77023 | 5207227263576 | F | A60 | 11.1 | 75 | 3000 | 1055 | 60 x 112 | 1\10\50 | 10 |
| 147-77024 | 5207227283178 | F | A60 | 15 | 105 | 3000 | 1521 | 60 x 124 | 1\10\50 | 10 |
| 147-77030 | 5207227112713 | F | A60 | 4.9 | 40 | 2700 | 480 | 60 x 107 | 1\10\50 | 10 |
| 147-77031 | 5207227112744 | F | A60 | 7 | 50 | 2700 | 650 | 60 x 107 | 1\10\50 | 10 |
| 147-77032 | 5207227112775 | F | A60 | 8.8 | 60 | 2700 | 810 | 60 x 108 | 1\10\50 | 10 |
| 147-77033 | 5207227112805 | F | A60 | 11.1 | 75 | 2700 | 1055 | 60 x 110 | 1\10\50 | 10 |
| 147-77034 | 5207227112836 | F | A60 | 15 | 105 | 2700 | 1521 | 60 x 124 | 1\10\50 | 10 |

SMD
2835 A60 / A80 Ceramic



Voltage 175-250V 50\60Hz • Lifetime 25.000h • On\Off 25.000
Cover Ημιδιάφανο / Frost • Starting Time 0.5 sec • Operating Temperature -30° / +45°C
Υλικό / Material Πλαστικό με Ψύκτρα Αλουμινίου/ Plastic with Aluminium Heatsink

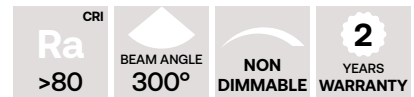

| Code | Barcode | Energy Class | Type | Watt | = Watt | Kelvin | Lumen | Dimension Ø (mm) † | Packing | MOQ |
|-----------|---------------|--------------|------|------|--------|--------|-------|--------------------|---------|-----|
| 147-77006 | 5207227115660 | E | A60 | 17 | 120 | 6500 | 2040 | 60 x 127 | 1\10\50 | 5 |
| 147-77007 | 5207227115844 | E | A80 | 24 | 155 | 6500 | 2800 | 80 x 161 | 1\10\30 | 5 |
| 147-77016 | 5207227116810 | E | A60 | 17 | 120 | 4000 | 2040 | 60 x 127 | 1\10\50 | 5 |
| 147-77017 | 5207227115721 | E | A80 | 24 | 155 | 4000 | 2800 | 80 x 161 | 1\10\30 | 5 |
| 147-77026 | 5207227283185 | E | A60 | 17 | 120 | 3000 | 2040 | 60 x 127 | 1\10\50 | 5 |
| 147-77027 | 5207227283192 | E | A80 | 24 | 155 | 3000 | 2800 | 80 x 161 | 1\10\30 | 5 |
| 147-77036 | 5207227115691 | E | A60 | 17 | 120 | 2700 | 2040 | 60 x 127 | 1\10\50 | 5 |
| 147-77037 | 5207227116841 | E | A80 | 24 | 155 | 2700 | 2800 | 80 x 161 | 1\10\30 | 5 |

SMD
2835 A60



B22 Base



Voltage 175-250V 50\60Hz • Lifetime 25.000h • On\Off 25.000
Cover Ημιδιάφανο / Frost • Starting Time 0.5 sec • Operating Temperature -30° / +45°C
Υλικό / Material Πλαστικό με Ψύκτρα Αλουμινίου/ Plastic with Aluminium Heatsin

CRI **Ra >80** BEAM ANGLE **300°** NON DIMMABLE 2 YEARS WARRANTY

| Code | Barcode | Energy Class | Type | Watt | = Watt | Kelvin | Lumen | Dimension Ø (mm) † | Packing | MOQ |
|-----------|---------------|--------------|------|------|--------|--------|-------|-----------------------|---------|-----|
| 147-77040 | 5207227116865 | G | A60 | 6 | 40 | 6500 | 480 | 60 x 107 | 1\10\50 | 10 |
| 147-77041 | 5207227116872 | G | A60 | 8 | 50 | 6500 | 650 | 60 x 107 | 1\10\50 | 10 |
| 147-77042 | 5207227113017 | F | A60 | 8.8 | 60 | 6500 | 810 | 60 x 107 | 1\10\50 | 10 |
| 147-77043 | 5207227113222 | F | A60 | 11.1 | 75 | 6500 | 1055 | 60 x 110 | 1\10\50 | 10 |
| 147-77044 | 5207227113253 | F | A60 | 15 | 100 | 6500 | 1521 | 60 x 121 | 1\10\50 | 10 |
| 147-77046 | 5207227116889 | E | A60 | 20 | 120 | 6500 | 2040 | 60 x 127 | 1\10\30 | 5 |
| 147-77050 | 5207227116896 | F | A60 | 4.9 | 40 | 4000 | 480 | 60 x 107 | 1\10\50 | 10 |
| 147-77051 | 5207227113109 | G | A60 | 8 | 50 | 4000 | 650 | 60 x 107 | 1\10\50 | 10 |
| 147-77052 | 5207227113130 | F | A60 | 8.8 | 60 | 4000 | 810 | 60 x 107 | 1\10\50 | 10 |
| 147-77053 | 5207227113161 | F | A60 | 11.1 | 75 | 4000 | 1055 | 60 x 110 | 1\10\50 | 10 |
| 147-77054 | 5207227113192 | F | A60 | 15 | 100 | 4000 | 1521 | 60 x 121 | 1\10\50 | 10 |
| 147-77056 | 5207227116902 | E | A60 | 20 | 120 | 4000 | 2040 | 60 x 127 | 1\10\30 | 5 |
| 147-77070 | 5207227116919 | F | A60 | 4.9 | 40 | 2700 | 480 | 60 x 107 | 1\10\50 | 10 |
| 147-77071 | 5207227113048 | G | A60 | 8 | 50 | 2700 | 650 | 60 x 107 | 1\10\50 | 10 |
| 147-77072 | 5207227113079 | F | A60 | 8.8 | 60 | 2700 | 810 | 60 x 107 | 1\10\50 | 10 |
| 147-77073 | 5207227113284 | F | A60 | 11.1 | 75 | 2700 | 1055 | 60 x 110 | 1\10\50 | 10 |
| 147-77074 | 5207227113314 | F | A60 | 15 | 100 | 2700 | 1521 | 60 x 121 | 1\10\50 | 10 |
| 147-77076 | 5207227116926 | E | A60 | 20 | 120 | 2700 | 2040 | 60 x 127 | 1\10\30 | 5 |



LED SMD

Άπλετος οικονομικός φωτισμός με τους νέους SMD λαμπτήρες C-class! Plentiful economy lighting with the new SMD C-class lamps!

Οι νέες γενιάς λαμπτήρες LED SMD C-class της EUROLAMP κάνουν τη διαφορά! Στον πλούσιο φωτισμό και στο πορτοφόλι του καταναλωτή. Με ουσιαστική οικονομία 50%, ενεργειακή απόδοση 160Lm/W και 32 χρόνια διάρκεια ζωής, σας προσφέρουμε ένα προϊόν με πραγματικά υψηλή αξία!

EUROLAMP's new generation SMD C-class LED lamps make the difference! In the rich lighting and in the consumer's wallet. With a substantial economy of 50%, an energy efficiency of 160Lm/W and a 32-year lifespan, we offer you a really high value product!



160Lm/W
κορυφαία απόδοση
excellent performance

40,000h
32 years
lifetime

50% οικονομία
energy saving

σε σύγκριση με τις κοινές λάμπες LED
comparing with standard SMD LED bulbs



και σε νέα
οικολογική
συσκευασία!
new environment
friendly packaging!

Πιστοποιημένα χαρτιά FSC® με προέλευση
από υπεύθυνες πηγές.
FSC® certified papers from responsible sources.



SMD
2835 A60



E27 Base



Voltage 220-240V 50\60Hz • Lifetime 25.000h • On\Off 25.000
Cover Ημιδιάφανο / Frost • Starting Time 0.5 sec • Operating Temperature -30° / +45°C
Υλικό / Material Πλαστικό με Ψύκτρα Αλουμινίου/ Plastic with Aluminium Heatsink



| Code | Barcode | Energy Class | Type | Watt | = Watt | Kelvin | Lumen | Dimension Ø (mm) † | Packing | MOQ |
|-----------|---------------|--------------|------|------|--------|--------|-------|-----------------------|---------|-----|
| 147-84402 | 5206139991027 | G | A60 | 8 | 55 | 6500 | 650 | 60 x 108 | 1\10\50 | 10 |
| 147-84404 | 5206139015280 | G | A60 | 11 | 70 | 6500 | 920 | 60 x 108 | 1\10\50 | 10 |
| 147-84405 | 5206139040480 | F | A60 | 13 | 80 | 6500 | 1170 | 60 x 110 | 1\10\50 | 10 |
| 147-84406 | 5207227058660 | F | A60 | 15 | 105 | 6500 | 1521 | 60 x 120 | 1\10\50 | 10 |
| 147-84412 | 5206139991126 | G | A60 | 8 | 55 | 2700 | 650 | 60 x 108 | 1\10\50 | 10 |
| 147-84414 | 5206139015297 | G | A60 | 11 | 70 | 2700 | 920 | 60 x 108 | 1\10\50 | 10 |
| 147-84415 | 5206139040664 | F | A60 | 13 | 80 | 2700 | 1170 | 60 x 110 | 1\10\50 | 10 |
| 147-84416 | 5207227058691 | F | A60 | 15 | 105 | 2700 | 1521 | 60 x 120 | 1\10\50 | 10 |



| Code | Barcode | Energy Class | Type | Watt | = Watt | Kelvin | Lumen | Dimension Ø (mm) † | Packing | MOQ |
|-----------|---------------|--------------|------|------|--------|--------|-------|-----------------------|---------|-----|
| 147-79023 | 5207227168475 | F | A60 | 12 | 75 | 6500 | 1160 | 60 x 112 | 1\48 | 12 |
| 147-79024 | 5207227168499 | F | A60 | 12 | 75 | 4000 | 1160 | 60 x 112 | 1\48 | 12 |
| 147-79025 | 5207227168505 | F | A60 | 12 | 75 | 3000 | 1160 | 60 x 112 | 1\48 | 12 |

SMD
2835 A60



E27 Base



Voltage 220-240V 50\60Hz • Lifetime 25.000h • On\Off 25.000
Cover Ημιδιάφανο / Frost • Starting Time 0.5 sec • Operating Temperature -30° / +45°C
Υλικό / Material Πλαστικό με Ψύκτρα Αλουμινίου/ Plastic with Aluminium Heatsink



| Code | Barcode | Energy Class | Type | Watt | = Watt | Kelvin | Lumen | Dimension Ø (mm) † | Packing | MOQ |
|-----------|---------------|--------------|------|------|--------|--------|-------|-----------------------|---------|-----|
| 147-77103 | 5207227168598 | F | A60 | 12 | 75 | 6500 | 1160 | 60 x 112 | 1\50 | 10 |
| 147-77104 | 5207227168611 | F | A60 | 12 | 75 | 4000 | 1160 | 60 x 112 | 1\50 | 10 |

SMD
2835 A65



2 PCS E27 Base

CRI Ra >80 BEAM ANGLE 260° NON DIMMABLE 2 YEARS WARRANTY

Voltage 220-240V 50\60Hz • Lifetime 15.000h • On\Off 15.000
Cover Ημιδιάφανο / Frost • Starting Time 0.5 sec • Operating Temperature -30° / +45°C
Υλικό / Material Πλαστικό με Ψύκτρα Αλουμινίου/ Plastic with Aluminium Heatsink

| Code | Barcode | Energy Class | Type | Watt | = Watt | Kelvin | Lumen | Dimension Ø (mm) † | Packing | MOQ |
|-----------|---------------|--------------|------|------|--------|--------|-------|--------------------|---------|-----|
| 180-80280 | 5207227082795 | F | A65 | 15 | 95 | 6500 | 1450 | 65 x 128 | 1\5\30 | 5 |
| 180-80282 | 5207227082825 | F | A65 | 15 | 95 | 3000 | 1450 | 65 x 128 | 1\5\30 | 5 |



| Code | Barcode | Energy Class | Type | Watt | = Watt | Kelvin | Lumen | Dimension Ø (mm) † | Packing | MOQ |
|-----------|---------------|--------------|------|------|--------|--------|-------|--------------------|----------|-----|
| 180-77023 | 5207227112140 | F | A65 | 15 | 95 | 3000 | 1450 | 65 x 128.5 | 1\20\100 | 10 |
| 180-77033 | 5207227112089 | F | A65 | 15 | 95 | 2700 | 1450 | 65 x 128.5 | 1\20\100 | 10 |

A60

| Code | Barcode | Energy Class | Type | Watt | = Watt | Kelvin | Lumen | Dimension Ø (mm) † | Packing | MOQ |
|-----------|---------------|--------------|------|------|--------|--------|-------|--------------------|---------|-----|
| 180-80270 | 5207227079894 | F | A60 | 11.5 | 75 | 6500 | 975 | 60 x 112 | 1\5\30 | 5 |
| 180-80272 | 5207227079924 | F | A60 | 11.5 | 75 | 3000 | 975 | 60 x 112 | 1\5\30 | 5 |



SMD
2835 A60 Low Voltage

E27 Base

CRI Ra >80 BEAM ANGLE 230° NON DIMMABLE 2 YEARS WARRANTY

Voltage 12-24 AC/DC & 42 AC 50\60Hz • Lifetime 25.000h • On\Off 25.000
Cover Ημιδιάφανο / Frost • Starting Time 0.5 sec • Operating Temperature -30° / +45°C
Υλικό / Material Πλαστικό με Ψύκτρα Αλουμινίου/ Plastic with Aluminium Heatsink

| Code | Barcode | Energy Class | Type | Watt | = Watt | Kelvin | Lumen | Dimension Ø (mm) † | Packing | MOQ |
|-----------|---------------|--------------|------|------|--------|--------|-------|--------------------|---------|-----|
| 147-77180 | 5207227116933 | G | A60 | 10 | 60 | 6500 | 806 | 60 x 116 | 1\10\50 | 10 |
| 147-77182 | 5207227116940 | G | A60 | 10 | 60 | 3000 | 806 | 60 x 116 | 1\10\50 | 10 |



SMD
2835 T46 Tubular

E27 Base

CRI Ra >80 BEAM ANGLE 200° NON DIMMABLE 2 YEARS WARRANTY

Voltage 175-250V 50\60Hz • Lifetime 25.000h • On\Off 50.000
Cover Ημιδιάφανο / Frost • Starting Time 0.5 sec • Operating Temperature -30° / +45°C
Υλικό / Material Πλαστικό με Ψύκτρα Αλουμινίου/ Plastic with Aluminium Heatsink

| Code | Barcode | Energy Class | Type | Watt | = Watt | Kelvin | Lumen | Dimension Ø (mm) † | Packing | MOQ |
|-----------|---------------|--------------|------|------|--------|--------|-------|--------------------|---------|-----|
| 147-77466 | 5207227257711 | F | T46 | 11.1 | 75 | 6500 | 1055 | 46 x 124 | 1\10\50 | 5 |
| 147-77468 | 5207227257025 | F | T46 | 11.1 | 75 | 3000 | 1055 | 46 x 124 | 1\10\50 | 5 |

SMD
2835 C37



E14 Base



Voltage 175-265V 50\60Hz • Lifetime 40.000h • On\Off 50.000
Cover Ημιδιάφανο / Frost • Starting Time 0.5 sec • Operating Temperature -30° / +45°C
Υλικό / Material Πλαστικό με Ψύκτρα Αλουμινίου/ Plastic with Aluminium Heatsink

CRI **Ra >80** BEAM ANGLE **200°** **NON DIMMABLE** **5 YEARS WARRANTY**

| Code | Barcode | Energy Class | Type | Watt | = Watt | Kelvin | Lumen | Dimension Ø (mm) † | Packing | MOQ |
|-----------|---------------|--------------|------|------|--------|--------|-------|--------------------|---------|-----|
| 147-77200 | 5207227283208 | C | C37 | 2.9 | 40 | 6500 | 470 | 37 x 100 | 1\10\50 | 10 |
| 147-77201 | 5207227283215 | C | C37 | 2.9 | 40 | 4000 | 470 | 37 x 100 | 1\10\50 | 10 |
| 147-77202 | 5207227283222 | C | C37 | 2.9 | 40 | 3000 | 470 | 37 x 100 | 1\10\50 | 10 |
| 147-77207 | 5207227174858 | C | C37 | 5 | 60 | 6500 | 806 | 37 x 100 | 1\10\50 | 10 |
| 147-77208 | 5207227174865 | C | C37 | 5 | 60 | 4000 | 806 | 37 x 100 | 1\10\50 | 10 |
| 147-77209 | 5207227174872 | C | C37 | 5 | 60 | 3000 | 806 | 37 x 100 | 1\10\50 | 10 |



SMD
2835 C37 Ceramic



E14 Base



Voltage 175-265V 50\60Hz • Lifetime 40.000h • On\Off 50.000
Cover Ημιδιάφανο / Frost • Starting Time 0.5 sec • Operating Temperature -30° / +45°C
Υλικό / Material Κεραμικό & Πλαστικό / Ceramic & Plastic

CRI **Ra >80** BEAM ANGLE **160°** **NON DIMMABLE** **5 YEARS WARRANTY**

| Code | Barcode | Energy Class | Type | Watt | = Watt | Kelvin | Lumen | Dimension Ø (mm) † | Packing | MOQ |
|-----------|---------------|--------------|------|------|--------|--------|-------|--------------------|---------|-----|
| 147-77215 | 5207227412967 | D | C37 | 7.1 | 76 | 6500 | 1000 | 37 x 111 | 1\10\50 | 10 |
| 147-77216 | 5207227412998 | D | C37 | 7.1 | 76 | 4000 | 1000 | 37 x 110 | 1\10\50 | 10 |
| 147-77217 | 5207227413025 | D | C37 | 7.1 | 76 | 3000 | 1000 | 37 x 110 | 1\10\50 | 10 |

SMD
2835 C37



E14 Base



Voltage 220-240V 50\60Hz • Lifetime 25.000h • On\Off 25.000
Cover Ημιδιάφανο / Frost • Starting Time 0.5 sec • Operating Temperature -30° / +45°C
Υλικό / Material Πλαστικό με Ψύκτρα Αλουμινίου/ Plastic with Aluminium Heatsink

CRI **Ra >80** BEAM ANGLE **200°** NON DIMMABLE **2 YEARS WARRANTY**

| Code | Barcode | Energy Class | Type | Watt | = Watt | Kelvin | Lumen | Dimension Ø (mm) † | Packing | MOQ |
|-----------|---------------|--------------|------|------|--------|--------|-------|--------------------|---------|-----|
| 147-77203 | 5207227113345 | G | C37 | 5 | 40 | 6500 | 400 | 37 x 100 | 1\10\50 | 10 |
| 147-77204 | 5207227113376 | G | C37 | 5 | 40 | 4000 | 400 | 37 x 100 | 1\10\50 | 10 |
| 147-77205 | 5207227263606 | G | C37 | 5 | 40 | 3000 | 400 | 37 x 100 | 1\10\50 | 10 |
| 147-77206 | 5207227113406 | G | C37 | 5 | 40 | 2700 | 400 | 37 x 100 | 1\10\50 | 10 |
| 147-77211 | 5207227113437 | F | C37 | 7 | 50 | 6500 | 630 | 37 x 100 | 1\10\50 | 10 |
| 147-77212 | 5207227113468 | F | C37 | 7 | 50 | 4000 | 630 | 37 x 100 | 1\10\50 | 10 |
| 147-77213 | 5207227263637 | F | C37 | 7 | 50 | 3000 | 630 | 37 x 107 | 1\10\50 | 10 |
| 147-77214 | 5207227113499 | F | C37 | 7 | 50 | 2700 | 630 | 37 x 100 | 1\10\50 | 10 |

SMD
2835 C37



E14 Base



Voltage 220-240V 50\60Hz • Lifetime 25.000h • On\Off 25.000
Cover Ημιδιάφανο / Frost • Starting Time 0.5 sec • Operating Temperature -30° / +45°C
Υλικό / Material Πλαστικό με Ψύκτρα Αλουμινίου/ Plastic with Aluminium Heatsink

CRI **Ra >80** BEAM ANGLE **200°** NON DIMMABLE **2 YEARS WARRANTY**

| Code | Barcode | Energy Class | Type | Watt | = Watt | Kelvin | Lumen | Dimension Ø (mm) † | Packing | MOQ |
|-----------|---------------|--------------|------|------|--------|--------|-------|--------------------|---------|-----|
| 147-84422 | 5206139008527 | F | C37 | 4 | 35 | 6500 | 380 | 37 x 100 | 1\10\50 | 10 |
| 147-84423 | 5206139008558 | F | C37 | 4 | 35 | 2700 | 380 | 37 x 100 | 1\10\50 | 10 |
| 147-84424 | 5206139021984 | G | C37 | 6 | 40 | 6500 | 470 | 37 x 100 | 1\10\50 | 10 |
| 147-84425 | 5206139022035 | G | C37 | 6 | 40 | 2700 | 470 | 37 x 100 | 1\10\50 | 10 |



| Code | Barcode | Energy Class | Type | Watt | = Watt | Kelvin | Lumen | Dimension Ø (mm) † | Packing | MOQ |
|-----------|---------------|--------------|------|------|--------|--------|-------|--------------------|---------|-----|
| 147-79123 | 5207227168536 | F | C37 | 6 | 45 | 6500 | 520 | 37 x 98 | 1\48 | 10 |
| 147-79124 | 5207227168550 | F | C37 | 6 | 45 | 4000 | 520 | 37 x 98 | 1\48 | 10 |
| 147-79125 | 5207227168574 | F | C37 | 6 | 45 | 3000 | 520 | 37 x 98 | 1\48 | 10 |

SMD
2835 C37



E14 Base



Voltage 220-240V 50\60Hz • Lifetime 25.000h • On\Off 25.000
Cover Ημιδιάφανο / Frost • Starting Time 0.5 sec • Operating Temperature -30° / +45°C
Υλικό / Material Πλαστικό με Ψύκτρα Αλουμινίου/ Plastic with Aluminium Heatsink

| Code | Barcode | Energy Class | Type | Watt | = Watt | Kelvin | Lumen | Dimension Ø (mm) † | Packing | MOQ |
|-----------|---------------|--------------|------|------|--------|--------|-------|--------------------|---------|-----|
| 147-77250 | 5207227168673 | F | C37 | 6 | 50 | 6500 | 520 | 37 x 98 | 1\50 | 10 |
| 147-77251 | 5207227168697 | F | C37 | 6 | 50 | 4000 | 520 | 37 x 98 | 1\50 | 10 |

SMD
2835 C37



E14 Base



Voltage 220-240V 50\60Hz • Lifetime 15.000h • On\Off 15.000
Cover Ημιδιάφανο / Frost • Starting Time 0.5 sec • Operating Temperature -30° / +45°C
Υλικό / Material Πλαστικό με Ψύκτρα Αλουμινίου/ Plastic with Aluminium Heatsink

| Code | Barcode | Energy Class | Type | Watt | = Watt | Kelvin | Lumen | Dimension Ø (mm) † | Packing | MOQ |
|-----------|---------------|--------------|------|------|--------|--------|-------|--------------------|---------|-----|
| 180-80370 | 5207227082856 | F | C37 | 8 | 55 | 6500 | 690 | 37 x 107 | 1\5\30 | 5 |
| 180-80372 | 5207227082887 | F | C37 | 8 | 55 | 3000 | 690 | 37 x 107 | 1\5\30 | 5 |



SMD
2835 F37



E14 Base



Voltage 220-240V 50\60Hz • Lifetime 25.000h • On\Off 25.000
Cover Ημιδιάφανο / Frost • Starting Time 0.5 sec • Operating Temperature -30° / +45°C
Υλικό / Material Πλαστικό με Ψύκτρα Αλουμινίου/ Plastic with Aluminium Heatsink

| Code | Barcode | Energy Class | Type | Watt | = Watt | Kelvin | Lumen | Dimension Ø (mm) † | Packing | MOQ |
|-----------|---------------|--------------|------|------|--------|--------|-------|--------------------|---------|-----|
| 147-77261 | 5207227116957 | F | F37 | 7 | 50 | 4000 | 630 | 37 x 131 | 1\10\50 | 10 |
| 147-77263 | 5207227116964 | F | F37 | 7 | 50 | 2700 | 630 | 37 x 131 | 1\10\50 | 10 |



SMD
2835 G45



E14 Base



Voltage 175-265V 50\60Hz • Lifetime 40.000h • On\Off 50.000
Cover Ημιδιάφανο / Frost • Starting Time 0.5 sec • Operating Temperature -30° / +45°C
Υλικό / Material Πλαστικό με Ψύκτρα Αλουμινίου/ Plastic with Aluminium Heatsink

CRI **Ra >80** BEAM ANGLE **300°** NON DIMMABLE 5 YEARS WARRANTY

| Code | Barcode | Energy Class | Type | Watt | = Watt | Kelvin | Lumen | Dimension Ø (mm) † | Packing | MOQ |
|-----------|---------------|--------------|------|------|--------|--------|-------|--------------------|---------|-----|
| 147-77300 | 5207227283239 | C | G45 | 2.9 | 40 | 6500 | 470 | 45 x 80 | 1\10\50 | 10 |
| 147-77301 | 5207227283246 | C | G45 | 2.9 | 40 | 4000 | 470 | 45 x 80 | 1\10\50 | 10 |
| 147-77302 | 5207227283253 | C | G45 | 2.9 | 40 | 3000 | 470 | 45 x 80 | 1\10\50 | 10 |
| 147-77320 | 5207227174889 | C | G45 | 4.9 | 60 | 6500 | 806 | 45 x 80 | 1\10\50 | 10 |
| 147-77321 | 5207227174896 | C | G45 | 4.9 | 60 | 4000 | 806 | 45 x 80 | 1\10\50 | 10 |
| 147-77322 | 5207227174902 | C | G45 | 4.9 | 60 | 3000 | 806 | 45 x 80 | 1\10\50 | 10 |



SMD
2835 G45



E27 Base



Voltage 175-265V 50\60Hz • Lifetime 40.000h • On\Off 50.000
Cover Ημιδιάφανο / Frost • Starting Time 0.5 sec • Operating Temperature -30° / +45°C
Υλικό / Material Πλαστικό με Ψύκτρα Αλουμινίου/ Plastic with Aluminium Heatsink

CRI **Ra >80** BEAM ANGLE **300°** NON DIMMABLE 5 YEARS WARRANTY

| Code | Barcode | Energy Class | Type | Watt | = Watt | Kelvin | Lumen | Dimension Ø (mm) † | Packing | MOQ |
|-----------|---------------|--------------|------|------|--------|--------|-------|--------------------|---------|-----|
| 147-77304 | 5207227283260 | C | G45 | 2.9 | 40 | 6500 | 470 | 45 x 80 | 1\10\50 | 10 |
| 147-77305 | 5207227283277 | C | G45 | 2.9 | 40 | 4000 | 470 | 45 x 80 | 1\10\50 | 10 |
| 147-77306 | 5207227283284 | C | G45 | 2.9 | 40 | 3000 | 470 | 45 x 80 | 1\10\50 | 10 |
| 147-77324 | 5207227174919 | C | G45 | 4.9 | 60 | 6500 | 806 | 45 x 80 | 1\10\50 | 10 |
| 147-77325 | 5207227174926 | C | G45 | 4.9 | 60 | 4000 | 806 | 45 x 80 | 1\10\50 | 10 |
| 147-77326 | 5207227174933 | C | G45 | 4.9 | 60 | 3000 | 806 | 45 x 80 | 1\10\50 | 10 |

SMD
2835

G45 Ceramic



E14 Base



Voltage 175-265V 50\60Hz • Lifetime 40.000h • On\Off 50.000
Cover Ημιδιάφανο / Frost • Starting Time 0.5 sec • Operating Temperature -30° / +45°C
Υλικό / Material Κεραμικό & Πλαστικό / Ceramic & Plastic

| Code | Barcode | Energy Class | Type | Watt | = Watt | Kelvin | Lumen | Dimension Ø (mm) † | Packing | MOQ |
|-----------|---------------|--------------|------|------|--------|--------|-------|-----------------------|---------|-----|
| 147-77340 | 5207227413056 | | G45 | 7.1 | 76 | 6500 | 1000 | 45 x 90 | 1\10\50 | 10 |
| 147-77341 | 5207227413087 | | G45 | 7.1 | 76 | 4000 | 1000 | 45 x 90 | 1\10\50 | 10 |
| 147-77342 | 5207227413117 | | G45 | 7.1 | 76 | 3000 | 1000 | 45 x 90 | 1\10\50 | 10 |

SMD
2835

G45 Ceramic



E27 Base



Voltage 175-265V 50\60Hz • Lifetime 40.000h • On\Off 50.000
Cover Ημιδιάφανο / Frost • Starting Time 0.5 sec • Operating Temperature -30° / +45°C
Υλικό / Material Κεραμικό & Πλαστικό / Ceramic & Plastic

| Code | Barcode | Energy Class | Type | Watt | = Watt | Kelvin | Lumen | Dimension Ø (mm) † | Packing | MOQ |
|-----------|---------------|--------------|------|------|--------|--------|-------|-----------------------|---------|-----|
| 147-77343 | 5207227413148 | | G45 | 7.1 | 76 | 6500 | 1000 | 45 x 84 | 1\10\50 | 10 |
| 147-77344 | 5207227413179 | | G45 | 7.1 | 76 | 4000 | 1000 | 45 x 84 | 1\10\50 | 10 |
| 147-77345 | 5207227413209 | | G45 | 7.1 | 76 | 3000 | 1000 | 45 x 84 | 1\10\50 | 10 |

SMD
2835 G45



E14 Base



Voltage 175-250V 50\60Hz • Lifetime 25.000h • On\Off 25.000
Cover Ημιδιάφανο / Frost • Starting Time 0.5 sec • Operating Temperature -30° / +45°C
Υλικό / Material Πλαστικό με Ψύκτρα Αλουμινίου/ Plastic with Aluminium Heatsink

CRI **Ra >80** BEAM ANGLE **300°** NON DIMMABLE **2 YEARS WARRANTY**

| Code | Barcode | Energy Class | Type | Watt | = Watt | Kelvin | Lumen | Dimension Ø (mm) † | Packing | MOQ |
|-----------|---------------|--------------|------|------|--------|--------|-------|--------------------|---------|-----|
| 147-77310 | 5207227113529 | F | G45 | 4.9 | 40 | 6500 | 470 | 45 x 83 | 1\10\50 | 10 |
| 147-77311 | 5207227113826 | F | G45 | 4.9 | 40 | 4000 | 470 | 45 x 83 | 1\10\50 | 10 |
| 147-77312 | 5207227283291 | F | G45 | 4.9 | 40 | 3000 | 470 | 45 x 83 | 1\10\50 | 10 |
| 147-77313 | 5207227113550 | F | G45 | 4.9 | 40 | 2700 | 470 | 45 x 83 | 1\10\50 | 10 |
| 147-77330 | 5207227113642 | F | G45 | 7 | 60 | 6500 | 630 | 47 x 92 | 1\10\50 | 10 |
| 147-77331 | 5207227113673 | F | G45 | 7 | 60 | 4000 | 630 | 47 x 92 | 1\10\50 | 10 |
| 147-77332 | 5207227263668 | F | G45 | 7 | 60 | 3000 | 630 | 47 x 92 | 1\10\50 | 10 |
| 147-77333 | 5207227113703 | F | G45 | 7 | 60 | 2700 | 630 | 47 x 92 | 1\10\50 | 10 |
| 147-77353 | 5207227072819 | F | G45 | 10 | 70 | 2700 | 1000 | 45 x 89 | 1\10\50 | 10 |

SMD
2835 G45



E27 Base



Voltage 175-250V 50\60Hz • Lifetime 25.000h • On\Off 25.000
Cover Ημιδιάφανο / Frost • Starting Time 0.5 sec • Operating Temperature -30° / +45°C
Υλικό / Material Πλαστικό με Ψύκτρα Αλουμινίου/ Plastic with Aluminium Heatsink

CRI **Ra >80** BEAM ANGLE **300°** NON DIMMABLE **2 YEARS WARRANTY**

| Code | Barcode | Energy Class | Type | Watt | = Watt | Kelvin | Lumen | Dimension Ø (mm) † | Packing | MOQ |
|-----------|---------------|--------------|------|------|--------|--------|-------|--------------------|---------|-----|
| 147-77314 | 5207227113581 | F | G45 | 4.9 | 40 | 6500 | 470 | 45 x 83 | 1\10\50 | 10 |
| 147-77315 | 5207227113857 | F | G45 | 4.9 | 40 | 4000 | 470 | 45 x 83 | 1\10\50 | 10 |
| 147-77316 | 5207227283307 | F | G45 | 4.9 | 40 | 3000 | 470 | 45 x 83 | 1\10\50 | 10 |
| 147-77317 | 5207227113611 | F | G45 | 4.9 | 40 | 2700 | 470 | 45 x 83 | 1\10\50 | 10 |
| 147-77334 | 5207227113734 | F | G45 | 7 | 60 | 6500 | 630 | 47 x 88 | 1\10\50 | 10 |
| 147-77335 | 5207227113765 | F | G45 | 7 | 60 | 4000 | 630 | 47 x 88 | 1\10\50 | 10 |
| 147-77336 | 5207227263699 | F | G45 | 7 | 60 | 3000 | 630 | 47 x 88 | 1\10\50 | 10 |
| 147-77337 | 5207227113796 | F | G45 | 7 | 60 | 2700 | 630 | 47 x 88 | 1\10\50 | 10 |



SMD
2835 G45 Color



E27 Base



Voltage 175-265V 50\60Hz • Lifetime 25.000h • On\Off 25.000
Cover Ημιδιάφανο / Frost • Starting Time 0.5 sec • Operating Temperature -30° / +45°C
Υλικό / Material Πλαστικό με Ψύκτρα Αλουμινίου/ Plastic with Aluminium Heatsink

CRI **Ra >80** BEAM ANGLE **360°** NON DIMMABLE **2 YEARS WARRANTY**

| Code | Barcode | Type | Watt | = Watt | Color | Dimension Ø (mm) † | Packing | MOQ |
|-----------|---------------|------|------|--------|--------|--------------------|---------|-----|
| 147-77500 | 5207227413230 | G45 | 1.8 | 10 | YELLOW | 45 x 69 | 1/10/50 | 10 |
| 147-77501 | 5207227413261 | G45 | 1.8 | 10 | RED | 45 x 69 | 1/10/50 | 10 |
| 147-77502 | 5207227413292 | G45 | 1.8 | 10 | BLUE | 45 x 69 | 1/10/50 | 10 |

SMD
2835 G45



E14 Base



Voltage 220-240V 50\60Hz • Lifetime 25.000h • On\Off 25.000
Cover Ημιδιάφανο / Frost • Starting Time 0.5 sec • Operating Temperature -30° / +45°C
Υλικό / Material Πλαστικό με Ψύκτρα Αλουμινίου/ Plastic with Aluminium Heatsink



| Code | Barcode | Energy Class | Type | Watt | = Watt | Kelvin | Lumen | Dimension Ø (mm) † | Packing | MOQ |
|-----------|---------------|--------------|------|------|--------|--------|-------|--------------------|---------|-----|
| 147-84430 | 5206139008473 | F | G45 | 4 | 35 | 6500 | 380 | 45 x 83 | 1\10\50 | 10 |
| 147-84431 | 5206139006349 | F | G45 | 4 | 35 | 2700 | 380 | 45 x 83 | 1\10\50 | 10 |
| 147-84432 | 5206139028891 | G | G45 | 6 | 40 | 6500 | 470 | 45 x 83 | 1\10\50 | 10 |
| 147-84433 | 5206139028945 | G | G45 | 6 | 40 | 2700 | 470 | 45 x 83 | 1\10\50 | 10 |

SMD
2835 G45



E27 Base



Voltage 220-240V 50\60Hz • Lifetime 25.000h • On\Off 25.000
Cover Ημιδιάφανο / Frost • Starting Time 0.5 sec • Operating Temperature -30° / +45°C
Υλικό / Material Πλαστικό με Ψύκτρα Αλουμινίου/ Plastic with Aluminium Heatsink



| Code | Barcode | Energy Class | Type | Watt | = Watt | Kelvin | Lumen | Dimension Ø (mm) † | Packing | MOQ |
|-----------|---------------|--------------|------|------|--------|--------|-------|--------------------|---------|-----|
| 147-84440 | 5206139008398 | F | G45 | 4 | 35 | 6500 | 380 | 45 x 83 | 1\10\50 | 10 |
| 147-84441 | 5206139008442 | F | G45 | 4 | 35 | 2700 | 380 | 45 x 83 | 1\10\50 | 10 |
| 147-84442 | 5206139028976 | G | G45 | 6 | 40 | 6500 | 470 | 45 x 83 | 1\10\50 | 10 |
| 147-84443 | 5206139029034 | G | G45 | 6 | 40 | 2700 | 470 | 45 x 83 | 1\10\50 | 10 |

SMD
2835 G45



E14 Base



Voltage 220-240V 50\60Hz • Lifetime 15.000h • On\Off 15.000
Cover Ημιδιάφανο / Frost • Starting Time 0.5 sec • Operating Temperature -30° / +45°C
Υλικό / Material Πλαστικό με Ψύκτρα Αλουμινίου/ Plastic with Aluminium Heatsink



| Code | Barcode | Energy Class | Type | Watt | = Watt | Kelvin | Lumen | Dimension Ø (mm) † | Packing | MOQ |
|-----------|---------------|--------------|------|------|--------|--------|-------|--------------------|---------|-----|
| 180-80460 | 5207227033513 | G | G45 | 5 | 35 | 6500 | 400 | 45 x 83 | 1\5\30 | 5 |
| 180-80461 | 5207227033544 | G | G45 | 5 | 35 | 3000 | 400 | 45 x 83 | 1\5\30 | 5 |

SMD
2835 **G95 / G120**



E27 Base



Voltage 220-240V 50\60Hz • Lifetime 25.000h • On\Off 25.000
Cover Ημιδιάφανο / Frost • Starting Time 0.5 sec • Operating Temperature -30° / +45°C
Υλικό / Material Πλαστικό με Ψύκτρα Αλουμινίου/ Plastic with Aluminium Heatsink

CRI **Ra >80** BEAM ANGLE **270°** **NON DIMMABLE** **2 YEARS WARRANTY**

| Code | Barcode | Energy Class | Type | Watt | = Watt | Kelvin | Lumen | Dimension Ø (mm) † | Packing | MOQ |
|-----------|---------------|--------------|------|------|--------|--------|-------|--------------------|---------|-----|
| 147-77400 | 5207227113888 | E | G95 | 11 | 80 | 6500 | 1210 | 95 x 142 | 1\5\20 | 5 |
| 147-77401 | 5207227116995 | E | G95 | 11 | 80 | 4000 | 1210 | 95 x 142 | 1\5\20 | 5 |
| 147-77402 | 5207227113918 | E | G95 | 11 | 80 | 2700 | 1210 | 95 x 142 | 1\5\20 | 5 |
| 147-77406 | 5207227113949 | E | G120 | 13.8 | 100 | 6500 | 1521 | 120 x 160 | 1\5\20 | 5 |
| 147-77407 | 5207227064357 | E | G120 | 13.8 | 100 | 4000 | 1521 | 120 x 160 | 1\5\20 | 5 |
| 147-77408 | 5207227113970 | E | G120 | 13.8 | 100 | 2700 | 1521 | 120 x 160 | 1\5\20 | 5 |



SMD
2835 **G120 Ceramic**

Υλικό / Material Κεραμικό & Πλαστικό / Ceramic & Plastic

| Code | Barcode | Energy Class | Type | Watt | = Watt | Kelvin | Lumen | Dimension Ø (mm) † | Packing | MOQ |
|-----------|---------------|--------------|------|------|--------|--------|-------|--------------------|---------|-----|
| 147-77412 | 5207227115752 | E | G120 | 24 | 155 | 6500 | 2800 | 120 x 160 | 1\5\20 | 5 |
| 147-77413 | 5207227064388 | E | G120 | 24 | 155 | 4000 | 2800 | 120 x 160 | 1\5\20 | 5 |
| 147-77414 | 5207227115783 | E | G120 | 24 | 155 | 2700 | 2800 | 120 x 160 | 1\5\20 | 5 |



SMD
2835 R50



Voltage 220-240V 50\60Hz • Lifetime 25.000h • On\Off 25.000
Cover Ημιδιάφανο / Frost • Starting Time 0.5 sec • Operating Temperature -30° / +45°C
Υλικό / Material Πλαστικό με Ψύκτρα Αλουμινίου/ Plastic with Aluminium Heatsink

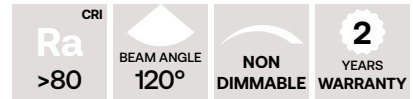

| Code | Barcode | Energy Class | Type | Watt | = Watt | Kelvin | Lumen | Dimension Ø (mm) † | Packing | MOQ |
|-----------|---------------|--------------|------|------|--------|--------|-------|--------------------|---------|-----|
| 147-77450 | 5207227114007 | G | R50 | 8 | 65 | 6500 | 640 | 50 x 86 | 1\10\30 | 10 |
| 147-77451 | 5207227072857 | G | R50 | 8 | 65 | 4000 | 640 | 50 x 86 | 1\10\30 | 10 |
| 147-77452 | 5207227114038 | G | R50 | 8 | 65 | 2700 | 640 | 50 x 86 | 1\10\30 | 10 |

SMD
2835 R63



Voltage 220-240V 50\60Hz • Lifetime 25.000h • On\Off 25.000
Cover Ημιδιάφανο / Frost • Starting Time 0.5 sec • Operating Temperature -30° / +45°C
Υλικό / Material Πλαστικό με Ψύκτρα Αλουμινίου/ Plastic with Aluminium Heatsink

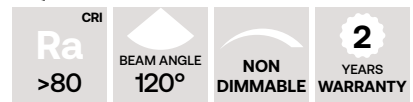

| Code | Barcode | Energy Class | Type | Watt | = Watt | Kelvin | Lumen | Dimension Ø (mm) † | Packing | MOQ |
|-----------|---------------|--------------|------|------|--------|--------|-------|--------------------|---------|-----|
| 147-77453 | 5207227114069 | G | R63 | 10 | 80 | 6500 | 800 | 63 x 101 | 1\10\30 | 10 |
| 147-77454 | 5207227072864 | G | R63 | 10 | 80 | 4000 | 800 | 63 x 101 | 1\10\30 | 10 |
| 147-77455 | 5207227114090 | G | R63 | 10 | 80 | 2700 | 800 | 63 x 101 | 1\10\30 | 10 |

SMD
2835 R80



Voltage 220-240V 50\60Hz • Lifetime 25.000h • On\Off 25.000
Cover Ημιδιάφανο / Frost • Starting Time 0.5 sec • Operating Temperature -30° / +45°C
Υλικό / Material Πλαστικό με Ψύκτρα Αλουμινίου/ Plastic with Aluminium Heatsink

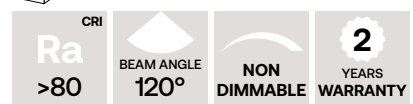

| Code | Barcode | Energy Class | Type | Watt | = Watt | Kelvin | Lumen | Dimension Ø (mm) † | Packing | MOQ |
|-----------|---------------|--------------|------|------|--------|--------|-------|--------------------|---------|-----|
| 147-77456 | 5207227060694 | F | R80 | 12 | 100 | 6500 | 1100 | 80 x 113 | 1\10\30 | 10 |
| 147-77457 | 5207227064098 | F | R80 | 12 | 100 | 4000 | 1100 | 80 x 113 | 1\10\30 | 10 |
| 147-77458 | 5207227060724 | F | R80 | 12 | 100 | 2700 | 1100 | 80 x 113 | 1\10\30 | 10 |

SMD
2835 R50 / R63



Voltage 220-240V 50\60Hz • Lifetime 25.000h • On\Off 25.000
Cover Ημιδιάφανο / Frost • Starting Time 0.5 sec • Operating Temperature -30° / +45°C
Υλικό / Material Πλαστικό με Ψύκτρα Αλουμινίου/ Plastic with Aluminium Heatsink

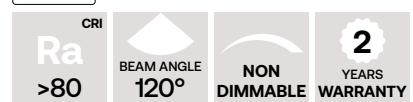

| Code | Barcode | Energy Class | Type | Base | Watt | = Watt | Kelvin | Lumen | Dimension Ø (mm) † | Packing | MOQ |
|-----------|---------------|--------------|------|------|------|--------|--------|-------|--------------------|---------|-----|
| 147-79452 | 5207227140723 | G | R50 | E14 | 8 | 97 | 3000 | 640 | 50 x 86 | 1\10\30 | 10 |
| 147-79455 | 5207227140754 | G | R63 | E27 | 10 | 144 | 3000 | 800 | 63 x 101 | 1\10\30 | 10 |

COB GU10



GU10 Base



Voltage 175-265V 50\60Hz • Lifetime 40.000h • On\Off 50.000
 Cover Διάφανο / Clear • Starting Time 0.5 sec • Operating Temperature -30° / +45°C
 Υλικό / Material Πλαστικό με Ψύκτρα Αλουμινίου/ Plastic with Aluminium Heatsink

CRI **Ra >80** BEAM ANGLE **38°** **NON DIMMABLE** **5 YEARS WARRANTY**

| Code | Barcode | Energy Class | Type | Watt | = Watt | Kelvin | Lumen | Dimension Ø (mm) ↓ | Packing | MOQ |
|-----------|---------------|--------------|------|------|--------|--------|-------|--------------------|----------|-----|
| 147-77830 | 5207227175053 | C | GU10 | 2.9 | 67 | 6500 | 430 | 50 x 56 | 1\10\100 | 10 |
| 147-77831 | 5207227175060 | C | GU10 | 2.9 | 67 | 4000 | 430 | 50 x 56 | 1\10\100 | 10 |
| 147-77832 | 5207227175077 | C | GU10 | 2.9 | 67 | 3000 | 430 | 50 x 56 | 1\10\100 | 10 |
| 147-77890 | 5207227283444 | C | GU10 | 4.9 | 110 | 6500 | 720 | 50 x 56 | 1\10\100 | 10 |
| 147-77891 | 5207227283451 | C | GU10 | 4.9 | 110 | 4000 | 720 | 50 x 56 | 1\10\100 | 10 |
| 147-77892 | 5207227283468 | C | GU10 | 4.9 | 110 | 3000 | 720 | 50 x 56 | 1\10\100 | 10 |



| Code | Barcode | Energy Class | Type | Watt | = Watt | Kelvin | Lumen | Dimension Ø (mm) ↓ | Packing | MOQ |
|-----------|---------------|--------------|------|------|--------|--------|-------|--------------------|----------|-----|
| 147-77835 | 5207227175084 | C | GU10 | 2.9 | 67 | 6500 | 430 | 50 x 56 | 1\10\100 | 10 |
| 147-77836 | 5207227175091 | C | GU10 | 2.9 | 67 | 4000 | 430 | 50 x 56 | 1\10\100 | 10 |
| 147-77837 | 5207227175107 | C | GU10 | 2.9 | 67 | 3000 | 430 | 50 x 56 | 1\10\100 | 10 |
| 147-77895 | 5207227283475 | C | GU10 | 4.9 | 110 | 6500 | 720 | 50 x 56 | 1\10\100 | 10 |
| 147-77896 | 5207227283482 | C | GU10 | 4.9 | 110 | 4000 | 720 | 50 x 56 | 1\10\100 | 10 |
| 147-77897 | 5207227283499 | C | GU10 | 4.9 | 110 | 3000 | 720 | 50 x 56 | 1\10\100 | 10 |

SMD 2835 GU10 Ceramic



GU10 Base



Voltage 175-265V 50\60Hz • Lifetime 40.000h • On\Off 50.000
 Cover Διάφανο / Clear • Starting Time 0.5 sec • Operating Temperature -30° / +45°C
 Υλικό / Material Κεραμικό & Πλαστικό / Ceramic & Plastic

CRI **Ra >80** BEAM ANGLE **38°** **NON DIMMABLE** **5 YEARS WARRANTY**

| Code | Barcode | Energy Class | Type | Watt | = Watt | Kelvin | Lumen | Dimension Ø (mm) ↓ | Packing | MOQ |
|-----------|---------------|--------------|------|------|--------|--------|-------|--------------------|----------|-----|
| 147-77887 | 5207227413629 | D | GU10 | 7.1 | 76 | 6500 | 945 | 50 x 57 | 1\10\100 | 10 |
| 147-77888 | 5207227413650 | D | GU10 | 7.1 | 76 | 4000 | 945 | 50 x 57 | 1\10\100 | 10 |
| 147-77889 | 5207227413681 | D | GU10 | 7.1 | 76 | 3000 | 945 | 50 x 57 | 1\10\100 | 10 |



| Code | Barcode | Energy Class | Type | Watt | = Watt | Kelvin | Lumen | Dimension Ø (mm) ↓ | Packing | MOQ |
|-----------|---------------|--------------|------|------|--------|--------|-------|--------------------|----------|-----|
| 147-77884 | 5207227413537 | D | GU10 | 7.1 | 76 | 6500 | 945 | 50 x 57 | 1\10\100 | 10 |
| 147-77885 | 5207227413568 | D | GU10 | 7.1 | 76 | 4000 | 945 | 50 x 57 | 1\10\100 | 10 |
| 147-77886 | 5207227413599 | D | GU10 | 7.1 | 76 | 3000 | 945 | 50 x 57 | 1\10\100 | 10 |

SMD
2835 GU10



GU10 Base



Voltage 175-250V & 220-240V 50\60Hz • Lifetime 25.000h • On\Off 25.000
Cover Διάφανο / Clear • Starting Time 0.5 sec • Operating Temperature -30° / +45°C
Υλικό / Material Πλαστικό με Ψύκτρα Αλουμινίου/ Plastic with Aluminium Heatsink

CRI Ra >80
BEAM ANGLE 38°
NON DIMMABLE
2 YEARS WARRANTY

| Code | Barcode | Energy Class | Type | Volt | Watt | = Watt | Kelvin | Lumen | Dimension Ø (mm) † | Packing | MOQ |
|-----------|---------------|--------------|------|---------|------|--------|--------|-------|--------------------|----------|-----|
| 147-77810 | 5207227117152 | F | GU10 | 175-250 | 4 | 55 | 6500 | 330 | 50 x 56 | 1\10\100 | 10 |
| 147-77811 | 5207227117169 | F | GU10 | 220-240 | 4 | 55 | 4000 | 330 | 50 x 56 | 1\10\100 | 10 |
| 147-77846 | 5207227264337 | F | GU10 | 220-240 | 4 | 55 | 3000 | 330 | 50 x 56 | 1\10\100 | 10 |
| 147-77812 | 5207227117176 | F | GU10 | 220-240 | 4 | 55 | 2700 | 330 | 50 x 56 | 1\10\100 | 10 |
| 147-77820 | 5207227114182 | F | GU10 | 220-240 | 6 | 85 | 6500 | 525 | 50 x 56 | 1\10\100 | 10 |
| 147-77821 | 5207227114212 | F | GU10 | 220-240 | 6 | 85 | 4000 | 525 | 50 x 56 | 1\10\100 | 10 |
| 147-77847 | 5207227264368 | F | GU10 | 175-250 | 6 | 85 | 3000 | 525 | 50 x 56 | 1\10\100 | 10 |
| 147-77822 | 5207227114243 | F | GU10 | 220-240 | 6 | 85 | 2700 | 525 | 50 x 56 | 1\10\100 | 10 |

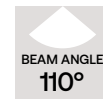

| Code | Barcode | Energy Class | Type | Volt | Watt | = Watt | Kelvin | Lumen | Dimension Ø (mm) † | Packing | MOQ |
|-----------|---------------|--------------|------|---------|------|--------|--------|-------|--------------------|----------|-----|
| 147-77813 | 5207227117183 | F | GU10 | 220-240 | 4 | 55 | 6500 | 380 | 50 x 56 | 1\10\100 | 10 |
| 147-77814 | 5207227117190 | F | GU10 | 220-240 | 4 | 55 | 4000 | 380 | 50 x 56 | 1\10\100 | 10 |
| 147-77848 | 5207227264399 | F | GU10 | 175-250 | 4 | 55 | 3000 | 380 | 50 x 56 | 1\10\100 | 10 |
| 147-77815 | 5207227117206 | F | GU10 | 220-240 | 4 | 55 | 2700 | 380 | 50 x 56 | 1\10\100 | 10 |
| 147-77823 | 5207227114274 | F | GU10 | 220-240 | 6 | 85 | 6500 | 530 | 50 x 56 | 1\10\100 | 10 |
| 147-77824 | 5207227114304 | F | GU10 | 220-240 | 6 | 85 | 4000 | 530 | 50 x 56 | 1\10\100 | 10 |
| 147-77849 | 5207227264429 | F | GU10 | 175-250 | 6 | 85 | 3000 | 530 | 50 x 56 | 1\10\100 | 10 |
| 147-77825 | 5207227114335 | F | GU10 | 220-240 | 6 | 85 | 2700 | 530 | 50 x 56 | 1\10\100 | 10 |

COB GU10



GU10 Base



Voltage 170-250V 50\60Hz • Lifetime 25.000h • On\Off 25.000
Cover Διάφανο / Clear • Starting Time 0.5 sec • Operating Temperature -30° / +45°C
Υλικό / Material Πλαστικό με Ψύκτρα Αλουμινίου/ Plastic with Aluminium Heatsink

CRI Ra >80
BEAM ANGLE 7°
NON DIMMABLE
3 YEARS WARRANTY

| Code | Barcode | Energy Class | Type | Volt | Watt | = Watt | Kelvin | Lumen | Dimension Ø (mm) † | Packing | MOQ |
|-----------|---------------|--------------|------|------|------|--------|--------|---------|--------------------|----------|-----|
| 147-77827 | 5207227149535 | F | GU10 | 6 | 85 | 4000 | 525 | 50 x 56 | 50 x 56 | 1\10\100 | 10 |
| 147-77828 | 5207227149566 | F | GU10 | 6 | 85 | 2700 | 525 | 50 x 56 | 50 x 56 | 1\10\100 | 10 |

SMD
2835 GU10



GU10 Base



Voltage 220-240V 50\60Hz • Lifetime 25.000h • On\Off 25.000
Cover Διάφανο / Clear • Starting Time 0.5 sec • Operating Temperature -30° / +45°C
Υλικό / Material Πλαστικό με Ψύκτρα Αλουμινίου/ Plastic with Aluminium Heatsink

CRI **Ra >80** BEAM ANGLE **38°** **NON DIMMABLE** **2 YEARS WARRANTY**

| Code | Barcode | Type | Watt | Color | Dimension Ø (mm) † | Packing | MOQ |
|-----------|---------------|------|------|-------------------------|--------------------|----------|-----|
| 147-77816 | 5207227117213 | GU10 | 4 | KOKKINO / RED | 50 x 56 | 1\10\100 | 5 |
| 147-77817 | 5207227114366 | GU10 | 4 | ΠΡΑΣΙΝΟ / GREEN | 50 x 56 | 1\10\100 | 5 |
| 147-77818 | 5207227114397 | GU10 | 4 | ΜΠΛΕ / BLUE | 50 x 56 | 1\10\100 | 5 |
| 147-77819 | 5207227117220 | GU10 | 4 | ΚΙΤΡΙΝΟ / YELLOW | 50 x 56 | 1\10\100 | 5 |

SMD
2835 GU10



GU10 Base



Voltage 220-240V 50\60Hz • Lifetime 25.000h • On\Off 25.000
Cover Ημιδιάφανο / Frost • Starting Time 0.5 sec • Operating Temperature -30° / +45°C
Υλικό / Material Πλαστικό με Ψύκτρα Αλουμινίου / Plastic with Aluminium Heatsink

CRI **Ra >80** BEAM ANGLE **38°** **DIMMABLE** **2 YEARS WARRANTY**

| Code | Barcode | Energy Class | Type | Watt | = Watt | Kelvin | Lumen | Dimension Ø (mm) † | Packing | MOQ |
|-----------|---------------|--------------|------|------|--------|--------|-------|--------------------|----------|-----|
| 147-77874 | 5207227072024 | E | GU10 | 6.5 | 100 | 6500 | 630 | 50 x 56 | 1\10\100 | 5 |
| 147-77875 | 5207227072055 | E | GU10 | 6.5 | 100 | 4000 | 630 | 50 x 56 | 1\10\100 | 5 |
| 147-77876 | 5207227072086 | E | GU10 | 6.5 | 100 | 3000 | 630 | 50 x 56 | 1\10\100 | 5 |
| 147-77877 | 5207227072116 | E | GU10 | 6.5 | 100 | 2700 | 630 | 50 x 56 | 1\10\100 | 5 |

BEAM ANGLE **120°** **DIMMABLE**

| Code | Barcode | Energy Class | Type | Watt | = Watt | Kelvin | Lumen | Dimension Ø (mm) † | Packing | MOQ |
|-----------|---------------|--------------|------|------|--------|--------|-------|--------------------|----------|-----|
| 147-77870 | 5207227076695 | F | GU10 | 6.5 | 100 | 6500 | 630 | 50 x 56 | 1\10\100 | 5 |
| 147-77871 | 5207227076725 | F | GU10 | 6.5 | 100 | 4000 | 630 | 50 x 56 | 1\10\100 | 5 |
| 147-77872 | 5207227076756 | F | GU10 | 6.5 | 100 | 3000 | 630 | 50 x 56 | 1\10\100 | 5 |
| 147-77873 | 5207227076787 | F | GU10 | 6.5 | 100 | 2700 | 630 | 50 x 56 | 1\10\100 | 5 |

SMD
2835 GU10



GU10 Base



Voltage 220-240V 50\60Hz • Lifetime 25.000h • On\Off 25.000
Cover Διάφανο / Clear • Starting Time 0.5 sec • Operating Temperature -30° / +45°C
Υλικό / Material Πλαστικό με Ψύκτρα Αλουμινίου/ Plastic with Aluminium Heatsink

CRI **Ra >80** BEAM ANGLE **110°** **NON DIMMABLE** **2 YEARS WARRANTY**

| Code | Barcode | Energy Class | Type | Watt | = Watt | Kelvin | Lumen | Dimension Ø (mm) † | Packing | MOQ |
|-----------|---------------|--------------|------|------|--------|--------|-------|--------------------|---------|-----|
| 147-79815 | 5207227139017 | G | GU10 | 4 | 55 | 2700 | 380 | 50 x 56 | 1\10\50 | 10 |

SMD
2835 GU10



GU10 Base

PLUS SERIES

CRI Ra >80

BEAM ANGLE 38°

DIMMABLE

2 YEARS WARRANTY

Voltage 175-250V 50\60Hz • Lifetime 25.000h • On\Off 25.000
 Cover Διάφανο / Clear • Starting Time 0.5 sec • Operating Temperature -30° / +45°C
 Υλικό / Material Γυαλί / Glass

| Code | Barcode | Energy Class | Type | Watt | = Watt | Kelvin | Lumen | Dimension Ø (mm) † | Packing | MOQ |
|-----------|---------------|--------------|------|------|--------|--------|-------|--------------------|----------|-----|
| 147-77861 | 5207227202070 | E | GU10 | 5.5 | 85 | 4000 | 550 | 51 x 55 | 1\10\100 | 10 |
| 147-77862 | 5207227202100 | E | GU10 | 5.5 | 85 | 3000 | 550 | 51 x 55 | 1\10\100 | 10 |
| 147-77863 | 5207227202131 | E | GU10 | 5.5 | 85 | 2700 | 550 | 51 x 55 | 1\10\100 | 10 |
| 147-77864 | 5207227175121 | G | GU10 | 5.5 | 85 | 6500 | 550 | 51 x 55 | 1\10\100 | 10 |

SMD
2835 MR11



G4 Base

PLUS SERIES

CRI Ra >80

BEAM ANGLE 36°

NON DIMMABLE

2 YEARS WARRANTY

Voltage 12 AC/DC 50\60Hz • Lifetime 25.000h • On\Off 25.000
 Cover Διάφανο / Clear • Starting Time 0.5 sec • Operating Temperature -30° / +45°C
 Υλικό / Material Γυαλί / Glass

| Code | Barcode | Energy Class | Type | Watt | = Watt | Kelvin | Lumen | Dimension Ø (mm) † | Packing | MOQ |
|-----------|---------------|--------------|------|------|--------|--------|-------|--------------------|----------|-----|
| 147-77806 | 5207227223044 | G | MR11 | 3 | 28 | 6500 | 220 | 35 x 38 | 1\10\100 | 10 |

SMD
2835 GU11



GU10 Base

PLUS SERIES

CRI Ra >80

BEAM ANGLE 120°

NON DIMMABLE

2 YEARS WARRANTY

Voltage 175-250V 50\60Hz • Lifetime 25.000h • On\Off 25.000
 Cover Ημιδιάφανο / Frost • Starting Time 0.5 sec • Operating Temperature -30° / +45°C
 Υλικό / Material Πλαστικό με Ψύκτρα Αλουμινίου/ Plastic with Aluminium Heatsink

| Code | Barcode | Energy Class | Type | Watt | = Watt | Kelvin | Lumen | Dimension Ø (mm) † | Packing | MOQ |
|-----------|---------------|--------------|------|------|--------|--------|-------|--------------------|----------|-----|
| 147-77880 | 5207227232350 | F | GU11 | 2.2 | 25 | 6500 | 200 | 35 x 46 | 1\10\100 | 10 |
| 147-77883 | 5207227232381 | F | GU11 | 2.2 | 25 | 2700 | 200 | 35 x 46 | 1\10\100 | 10 |

SMD
2835 MR16



GU5,3 Base



Voltage 12 AC/DC 50\60Hz • Lifetime 25.000h • On\Off 25.000
 Cover Ημιδιάφανο / Frost • Starting Time 0.5 sec • Operating Temperature -30° / +45°C
 Υλικό / Material Πλαστικό με Ψύκτρα Αλουμινίου/ Plastic with Aluminium Heatsink

| | | | |
|-----------------------------------|---------------------------|---------------------|-------------------------|
| CRI Ra >80 | BEAM ANGLE 105° | NON DIMMABLE | 2 YEARS WARRANTY |
|-----------------------------------|---------------------------|---------------------|-------------------------|

| Code | Barcode | Energy Class | Type | Watt | = Watt | Kelvin | Lumen | Dimension Ø (mm) † | Packing | MOQ |
|-----------|---------------|--------------|------|------|--------|--------|-------|-----------------------|----------|-----|
| 147-77853 | 5207227114120 | G | MR16 | 6 | 58 | 6500 | 480 | 50 x 48 | 1\10\100 | 10 |
| 147-77854 | 5207227117268 | G | MR16 | 6 | 58 | 4000 | 480 | 50 x 48 | 1\10\100 | 10 |
| 147-77855 | 5207227114151 | G | MR16 | 6 | 58 | 2700 | 480 | 50 x 48 | 1\10\100 | 10 |

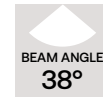

Cover Διάφανο / Clear

| Code | Barcode | Energy Class | Type | Watt | = Watt | Kelvin | Lumen | Dimension Ø (mm) † | Packing | MOQ |
|-----------|---------------|--------------|------|------|--------|--------|-------|-----------------------|----------|-----|
| 147-77850 | 5207227117237 | F | MR16 | 6 | 58 | 6500 | 480 | 50 x 48 | 1\10\100 | 10 |
| 147-77851 | 5207227117244 | F | MR16 | 6 | 58 | 4000 | 480 | 50 x 48 | 1\10\100 | 10 |
| 147-77852 | 5207227117251 | F | MR16 | 6 | 58 | 2700 | 480 | 50 x 48 | 1\10\100 | 10 |



Κεραμική βάση για μέγιστη αντοχή!

Ceramic base for maximum durability!

Περισσότερη φωτεινότητα,
μεγαλύτερη διάρκεια ζωής,
απόλυτη αξιοπιστία.

More brightness, longer lifespan,
ultimate reliability.



Οι λαμπτήρες EUROLAMP με κεραμική βάση αντέχουν στη θερμότητα και τον χρόνο. Παρέχουν υψηλή φωτεινότητα για περισσότερα χρόνια, χωρίς φθορά και διάβρωση. Επιλέξτε αντοχή και απόδοση με έως και 5 χρόνια εγγύηση.

EUROLAMP bulbs with a ceramic base withstand heat and time. They provide high brightness for years, without wear or corrosion. Choose durability and performance with up to 5-year warranty.

κεραμική βάση
για αντοχή στη θερμότητα
ceramic base for heat
resistance

δεν φθείρεται
και δεν διαβρώνεται
no wear and no corrosion

1000+ lumen
υψηλή φωτεινότητα
high brightness



μακροχρόνια απόδοση
χωρίς απώλειες
long-lasting performance
without loss

COB G4



G4 Base



Voltage 12 AC/DC 50\60Hz • Lifetime 25.000h • On\Off 25.000
 Cover Διάφανο / Clear • Starting Time 0.5 sec • Operating Temperature -30° / +45°C
 Υλικό / Material Σιλικόνη & PCB / Silicone & PCB

CRI **Ra >80** BEAM ANGLE **360°** NON DIMMABLE 2 YEARS WARRANTY

| Code | Barcode | Energy Class | Type | Watt | = Watt | Kelvin | Lumen | Dimension Ø (mm) † | Packing | MOQ |
|-----------|---------------|--------------|------|------|--------|--------|-------|--------------------|-------------|-----|
| 147-77600 | 5207227072888 | F | G4 | 2 | 20 | 6500 | 220 | 11,5 x 37 | 1\10\50\200 | 10 |
| 147-77601 | 5207227072895 | F | G4 | 2 | 20 | 4000 | 220 | 11,5 x 37 | 1\10\50\200 | 10 |
| 147-77602 | 5207227072901 | F | G4 | 2 | 20 | 2700 | 220 | 11,5 x 37 | 1\10\50\200 | 10 |
| 147-77603 | 5207227036835 | F | G4 | 3 | 30 | 6500 | 300 | 12 x 41 | 1\10\50\200 | 10 |
| 147-77604 | 5207227036842 | F | G4 | 3 | 30 | 4000 | 300 | 12 x 41 | 1\10\50\200 | 10 |
| 147-77605 | 5207227064654 | F | G4 | 3 | 30 | 2700 | 300 | 12 x 41 | 1\10\50\200 | 10 |

SMD 2835 G4



G4 Base



Voltage 12 AC/DC 50\60Hz • Lifetime 25.000h • On\Off 25.000
 Cover Διάφανο / Clear • Starting Time 0.5 sec • Operating Temperature -30° / +45°C
 Υλικό / Material Σιλικόνη & PCB / Silicone & PCB

CRI **Ra >80** BEAM ANGLE **360°** NON DIMMABLE 2 YEARS WARRANTY

| Code | Barcode | Energy Class | Type | Watt | = Watt | Kelvin | Lumen | Dimension Ø (mm) † | Packing | MOQ |
|-----------|---------------|--------------|------|------|--------|--------|-------|--------------------|----------|-----|
| 147-84608 | 5206139021182 | G | G4 | 1,5 | 13 | 6500 | 120 | 9,5 x 34,5 | 1\10\200 | 10 |
| 147-84610 | 5207227022203 | F | G4 | 2 | 20 | 6500 | 200 | 10 x 37 | 1\10\200 | 10 |
| 147-84611 | 5207227022241 | F | G4 | 2 | 20 | 2700 | 200 | 10 x 37 | 1\10\200 | 10 |

COB G9



G9 Base



Voltage 220-240V 50\60Hz • Lifetime 25.000h • On\Off 25.000
 Cover Διάφανο / Clear • Starting Time 0.5 sec • Operating Temperature -30° / +45°C
 Υλικό / Material Γυαλί / Glass

CRI **Ra >80** BEAM ANGLE **360°** NON DIMMABLE 2 YEARS WARRANTY

| Code | Barcode | Energy Class | Type | Watt | = Watt | Kelvin | Lumen | Dimension Ø (mm) † | Packing | MOQ |
|-----------|---------------|--------------|------|------|--------|--------|-------|--------------------|-------------|-----|
| 147-77640 | 5207227117060 | E | G9 | 2 | 25 | 6500 | 250 | 13,3 x 50 | 1\10\50\200 | 10 |
| 147-77641 | 5207227117077 | E | G9 | 2 | 25 | 4000 | 250 | 13,3 x 50 | 1\10\50\200 | 10 |
| 147-77642 | 5207227117084 | E | G9 | 2 | 25 | 3000 | 250 | 13,3 x 50 | 1\10\50\200 | 10 |
| 147-77645 | 5207227117091 | E | G9 | 4 | 40 | 6500 | 450 | 13,3 x 60 | 1\10\50\200 | 10 |
| 147-77646 | 5207227117107 | E | G9 | 4 | 40 | 4000 | 450 | 13,3 x 60 | 1\10\50\200 | 10 |
| 147-77647 | 5207227117114 | E | G9 | 4 | 40 | 3000 | 450 | 13,3 x 60 | 1\10\50\200 | 10 |

SMD
2835

G9 Ceramic



G9 Base



Voltage 175-265V 50\60Hz • Lifetime 25.000h • On\Off 25.000
Cover Διάφανο / Clear • Starting Time 0.5 sec • Operating Temperature -30° / +45°C
Υλικό / Material Κεραμικό & PCB / Ceramic & PCB

| | Barcode | Energy Class | Type | Watt | = Watt | Kelvin | Lumen | Dimension Ø (mm) † | Packing | MOQ |
|-----------|---------------|--------------|------|------|--------|--------|-------|-----------------------|-------------|-----|
| 147-77656 | 5207227413360 | D | G9 | 7 | 75 | 6500 | 1000 | 18,5 x 75 | 1\10\50\200 | 10 |
| 147-77657 | 5207227413407 | D | G9 | 7 | 75 | 4000 | 1000 | 18,5 x 75 | 1\10\50\200 | 10 |
| 147-77658 | 5207227413445 | D | G9 | 7 | 75 | 3000 | 1000 | 18,5 x 75 | 1\10\50\200 | 10 |

SMD
2835

G9



G9 Base



Voltage 220-240V 50\60Hz • Lifetime 25.000h • On\Off 25.000
Cover Διάφανο / Clear • Starting Time 0.5 sec • Operating Temperature -30° / +45°C
Υλικό / Material Κεραμικό & Πλαστικό/ Ceramic & Plastic

| Code | Barcode | Energy Class | Type | Watt | = Watt | Kelvin | Lumen | Dimension Ø (mm) † | Packing | MOQ |
|-----------|---------------|--------------|------|------|--------|--------|-------|-----------------------|-------------|-----|
| 147-77624 | 5207227106552 | E | G9 | 3.6 | 35 | 6500 | 400 | 16,5 x 50 | 1\10\50\200 | 10 |
| 147-77625 | 5207227073878 | E | G9 | 3.6 | 35 | 4000 | 400 | 16,5 x 50 | 1\10\50\200 | 10 |
| 147-77626 | 5207227106590 | E | G9 | 3.6 | 35 | 2700 | 400 | 16,5 x 50 | 1\10\50\200 | 10 |
| 147-77627 | 5207227106637 | E | G9 | 5 | 50 | 6500 | 580 | 19 x 52 | 1\10\50\200 | 10 |
| 147-77628 | 5207227076800 | E | G9 | 5 | 50 | 4000 | 580 | 19 x 52 | 1\10\50\200 | 10 |
| 147-77629 | 5207227106675 | E | G9 | 5 | 50 | 2700 | 580 | 19 x 52 | 1\10\50\200 | 10 |

SMD
2835 G9



Voltage 220-240V 50\60Hz • Lifetime 25.000h • On\Off 25.000
Cover Ημιδιάφανο / Frost • Starting Time 0.5 sec • Operating Temperature -30° / +45°C
Υλικό / Material Κεραμικό & Πλαστικό/ Ceramic & Plastic

CRI Ra >80
BEAM ANGLE 360°
DIMMABLE
2 YEARS WARRANTY

| | Barcode | Energy Class | Type | Watt | = Watt | Kelvin | Lumen | Dimension Ø (mm) † | Packing | MOQ |
|-----------|---------------|--------------|------|------|--------|--------|-------|--------------------|-------------|-----|
| 147-77650 | 5207227106712 | F | G9 | 4 | 35 | 6500 | 400 | 18 x 54 | 1\10\50\200 | 10 |
| 147-77651 | 5207227106750 | F | G9 | 4 | 35 | 4000 | 400 | 18 x 54 | 1\10\50\200 | 10 |
| 147-77652 | 5207227106798 | F | G9 | 4 | 35 | 3000 | 400 | 18 x 54 | 1\10\50\200 | 10 |

SMD
2835 G9



Voltage 220-240V 50\60Hz • Lifetime 25.000h • On\Off 25.000
Cover Διάφανο / Clear • Starting Time 0.5 sec • Operating Temperature -30° / +45°C
Υλικό / Material Κεραμικό & Πλαστικό/ Ceramic & Plastic

2 PCS
CRI Ra >80
BEAM ANGLE 360°
NON DIMMABLE
2 YEARS WARRANTY

| | Barcode | Energy Class | Type | Watt | = Watt | Kelvin | Lumen | Dimension Ø (mm) † | Packing | MOQ |
|-----------|---------------|--------------|------|------|--------|--------|-------|--------------------|----------|-----|
| 800-84654 | 5207227029233 | F | G9 | 6 | 50 | 4000 | 580 | 16 x 62 | 1\10\100 | 10 |
| 800-84655 | 5207227029264 | F | G9 | 6 | 50 | 2700 | 580 | 16 x 62 | 1\10\100 | 10 |

COB R7s



Voltage 220-240V 50\60Hz • Lifetime 25.000h • On\Off 25.000
Cover Ημιδιάφανο / Frost • Starting Time 0.5 sec • Operating Temperature -30° / +45°C
Υλικό / Material Γυαλί & Κεραμική Βάση / Glass & Ceramic Base

CRI Ra >80
BEAM ANGLE 360°
NON DIMMABLE
3 YEARS WARRANTY

| | Barcode | Energy Class | Type | Watt | = Watt | Kelvin | Lumen | Dimension Ø (mm) † | Packing | MOQ |
|-----------|---------------|--------------|------|------|--------|--------|-------|--------------------|----------|-----|
| 147-77691 | 5207227228063 | E | R7s | 4.2 | 45 | 4000 | 550 | 16 x 78 | 1\10\200 | 5 |
| 147-77692 | 5207227228087 | E | R7s | 4.2 | 45 | 3000 | 550 | 16 x 78 | 1\10\200 | 5 |
| 147-77696 | 5207227228100 | E | R7s | 8 | 75 | 4000 | 1055 | 16 x 118 | 1\10\200 | 5 |
| 147-77697 | 5207227228131 | E | R7s | 8 | 75 | 3000 | 1055 | 16 x 118 | 1\10\200 | 5 |

SMD
2835 GX53
3000K 4000K 6500K



Voltage 220-240V 50\60Hz • Lifetime 40.000h • On\Off 50.000
Cover Γάλακτος / Milky • Starting Time 0.5 sec • Operating Temperature -30° / +45°C
Υλικό / Material Πλαστικό - Αλουμίνιο / Plastic - Aluminum

CRI Ra >80
BEAM ANGLE 120°
NON DIMMABLE
2 YEARS WARRANTY

| | Barcode | Energy Class | Type | Watt | = Watt | Kelvin | Lumen | Dimension Ø (mm) † | Packing | MOQ |
|-----------|---------------|--------------|------|------|--------|--------|-------|--------------------|----------|-----|
| 147-77510 | 5207227413322 | F | GX53 | 8 | 60 | 3CCT | 680 | 74 x 25 | 1/10/100 | 10 |

Λαμπτήρες SMD
LED Tube

SMD Led Tubes



SMD 2835 G13 T8 60cm / 120cm / 150cm

Voltage 175-265V 50\60Hz • Lifetime 100.000h • On\Off 200.000
 Cover Frost • Starting Time 0.5 sec • Operating Temperature -30° / +45°C
 Υλικό / Material Γυαλί & Πλαστική Βάση / Glass & Plastic Base

G13 Base

CRI Ra >80 BEAM ANGLE 220° NON DIMMABLE 5 YEARS WARRANTY

| Code | Barcode | Energy Class | Type | Watt | Kelvin | Lumen | Dimension Ø (mm) † | Height (Edge-Edge) | Weight (kg) | Packing | MOQ |
|-----------|---------------|--------------|------|------|--------|-------|--------------------|--------------------|-------------|---------|-----|
| 147-77760 | 5207227282515 | C | T8 | 7 | 6500 | 1120 | 28 x 600 | 588 | 0,121 | 1/25 | 10 |
| 147-77761 | 5207227282539 | C | T8 | 7 | 4000 | 1120 | 28 x 600 | 588 | 0,121 | 1/25 | 10 |
| 147-77762 | 5207227286322 | C | T8 | 7 | 3000 | 1120 | 28 x 600 | 588 | 0,121 | 1/25 | 10 |
| 147-77763 | 5207227282553 | C | T8 | 13 | 6500 | 2080 | 28 x 1200 | 1198 | 0,215 | 1/25 | 10 |
| 147-77764 | 5207227282577 | C | T8 | 13 | 4000 | 2080 | 28 x 1200 | 1198 | 0,215 | 1/25 | 10 |
| 147-77765 | 5207227286339 | C | T8 | 13 | 3000 | 2080 | 28 x 1200 | 1198 | 0,215 | 1/25 | 10 |
| 147-77766 | 5207227282591 | C | T8 | 18.5 | 6500 | 2960 | 28 x 1500 | 1498 | 0,236 | 1/25 | 10 |
| 147-77767 | 5207227282614 | C | T8 | 18.5 | 4000 | 2960 | 28 x 1500 | 1498 | 0,236 | 1/25 | 10 |
| 147-77768 | 5207227286346 | C | T8 | 18.5 | 3000 | 2960 | 28 x 1500 | 1498 | 0,236 | 1/25 | 10 |
| 147-77721 | 5207227170621 | C | T8 | 9 | 4000 | 1440 | 28 x 600 | 588 | 0,121 | 1/25 | 10 |
| 147-77722 | 5207227170645 | C | T8 | 9 | 3000 | 1440 | 28 x 600 | 588 | 0,121 | 1/25 | 10 |

SMD 2835 G13 T8 60cm / 120cm / 150cm

Voltage 90-265V 50\60Hz • Lifetime 50.000h • On\Off 50.000
 Cover Frost • Starting Time 0.5 sec • Operating Temperature -30° / +45°C
 Υλικό / Material Γυαλί & Πλαστική Βάση / Glass & Plastic Base

G13 Base

CRI Ra >80 BEAM ANGLE 300° NON DIMMABLE 3 YEARS WARRANTY

| Code | Barcode | Energy Class | Type | Watt | Kelvin | Lumen | Dimension Ø (mm) † | Height (Edge-Edge) | Weight (kg) | Packing | MOQ |
|-----------|---------------|--------------|------|------|--------|-------|--------------------|--------------------|-------------|---------|-----|
| 147-77770 | 5207227282492 | D | T8 | 7.5 | 6500 | 1015 | 28 x 600 | 588 | 0,096 | 1/25 | 10 |
| 147-77771 | 5207227286353 | D | T8 | 7.5 | 4000 | 1015 | 28 x 600 | 588 | 0,096 | 1/25 | 10 |
| 147-77772 | 5207227286360 | D | T8 | 7.5 | 3000 | 1015 | 28 x 600 | 588 | 0,096 | 1/25 | 10 |
| 147-77773 | 5207227282478 | D | T8 | 14 | 6500 | 1890 | 28 x 1200 | 1198 | 0,173 | 1/25 | 10 |
| 147-77774 | 5207227286377 | D | T8 | 14 | 4000 | 1890 | 28 x 1200 | 1198 | 0,173 | 1/25 | 10 |
| 147-77775 | 5207227286384 | D | T8 | 14 | 3000 | 1890 | 28 x 1200 | 1198 | 0,173 | 1/25 | 10 |
| 147-77776 | 5207227286391 | D | T8 | 20 | 6500 | 2700 | 28 x 1500 | 1498 | 0,285 | 1/25 | 10 |
| 147-77777 | 5207227286407 | D | T8 | 20 | 4000 | 2700 | 28 x 1500 | 1498 | 0,285 | 1/25 | 10 |
| 147-77778 | 5207227286414 | D | T8 | 20 | 3000 | 2700 | 28 x 1500 | 1498 | 0,285 | 1/25 | 10 |
| 147-77731 | 5207227174971 | D | T8 | 9 | 4000 | 1215 | 28 x 600 | 588 | 0,096 | 1/25 | 10 |
| 147-77733 | 5207227174995 | D | T8 | 18 | 6500 | 2430 | 28 x 1200 | 1198 | 0,173 | 1/25 | 10 |
| 147-77734 | 5207227175008 | D | T8 | 18 | 4000 | 2430 | 28 x 1200 | 1198 | 0,173 | 1/25 | 10 |
| 147-77736 | 5207227175022 | D | T8 | 22 | 6500 | 2970 | 28 x 1500 | 1498 | 0,206 | 1/25 | 10 |
| 147-77737 | 5207227175039 | D | T8 | 22 | 4000 | 2970 | 28 x 1500 | 1498 | 0,206 | 1/25 | 10 |
| 147-77738 | 5207227175046 | D | T8 | 22 | 3000 | 2970 | 28 x 1500 | 1498 | 0,206 | 1/25 | 10 |



SMD
2835

G13 T8

45cm / 60cm / 90cm / 100cm / 120cm / 150cm



Voltage 175-265V 50\60Hz • Lifetime 25.000h • On\Off 50.000
Cover Frost • Starting Time 0.5 sec • Operating Temperature -30° / +45°C
Υλικό / Material Γυαλί & Πλαστική Βάση / Glass & Plastic Base

CRI **Ra >80** BEAM ANGLE **300°** NON DIMMABLE 2 YEARS WARRANTY

| Code | Barcode | Energy Class | Type | Watt | Kelvin | Lumen | Dimension Ø (mm) † | Height (Edge-Edge) | Weight (kg) | Packing | MOQ |
|-----------|---------------|--------------|------|------|--------|-------|--------------------|--------------------|-------------|---------|-----|
| 180-77740 | 5207227064418 | E | T8 | 5 | 6500 | 550 | 28 x 450 | 434 | 0,078 | 1/25 | 10 |
| 180-77741 | 5207227064425 | E | T8 | 8 | 6500 | 920 | 28 x 600 | 588 | 0,096 | 1/25 | 10 |
| 180-77742 | 5207227073144 | E | T8 | 8 | 4000 | 920 | 28 x 600 | 588 | 0,096 | 1/25 | 10 |
| 180-77746 | 5207227088735 | E | T8 | 13 | 6500 | 1470 | 28 x 900 | 894 | 0,139 | 1/25 | 10 |
| 180-77747 | 5207227088759 | E | T8 | 13 | 4000 | 1470 | 28 x 900 | 894 | 0,139 | 1/25 | 10 |
| 180-77750 | 5207227064449 | F | T8 | 15 | 4000 | 1575 | 28 x 1000 | 970 | 0,147 | 1/25 | 10 |
| 180-77748 | 5207227295829 | E | T8 | 16 | 6500 | 1840 | 28 x 1200 | 1198 | 0,179 | 1/25 | 10 |
| 180-77749 | 5207227064432 | E | T8 | 16 | 4000 | 1840 | 28 x 1200 | 1198 | 0,179 | 1/25 | 10 |
| 180-77757 | 5207227295836 | E | T8 | 22 | 6500 | 2530 | 28 x 1500 | 1498 | 0,285 | 1/25 | 10 |
| 180-77758 | 5207227295843 | E | T8 | 22 | 4000 | 2530 | 28 x 1500 | 1498 | 0,285 | 1/25 | 10 |
| 180-77744 | 5207227088711 | E | T8 | 10 | 4000 | 1100 | 28 x 600 | 588 | 0,096 | 1/25 | 10 |
| 180-77753 | 5207227102165 | E | T8 | 18 | 4000 | 1980 | 28 x 1200 | 1198 | 0,179 | 1/25 | 10 |
| 180-77756 | 5207227102172 | E | T8 | 24 | 4000 | 2640 | 28 x 1500 | 1498 | 0,285 | 1/25 | 10 |

SMD
2835

G13 T8 "2 άκρων" - " 2 Ends"

60cm / 120cm / 150cm



Voltage 175-265V 50\60Hz • Lifetime 25.000h • On\Off 50.000
Cover Frost • Starting Time 0.5 sec • Operating Temperature -30° / +45°C
Υλικό / Material Γυαλί & Πλαστική Βάση / Glass & Plastic Base

CRI **Ra >80** BEAM ANGLE **300°** NON DIMMABLE 2 YEARS WARRANTY

| Code | Barcode | Energy Class | Type | Watt | Kelvin | Lumen | Dimension Ø (mm) † | Height (Edge-Edge) | Weight (kg) | Packing | MOQ |
|-----------|---------------|--------------|------|------|--------|-------|--------------------|--------------------|-------------|---------|-----|
| 180-77720 | 5207227146923 | E | T8 | 10 | 6500 | 1100 | 28 x 600 | 588 | 0,096 | 1/25 | 10 |
| 180-77721 | 5207227146947 | E | T8 | 10 | 4000 | 1100 | 28 x 600 | 588 | 0,096 | 1/25 | 10 |
| 180-77723 | 5207227146961 | E | T8 | 18 | 6500 | 1980 | 28 x 1200 | 1198 | 0,179 | 1/25 | 10 |
| 180-77724 | 5207227146985 | E | T8 | 18 | 4000 | 1980 | 28 x 1200 | 1198 | 0,179 | 1/25 | 10 |
| 180-77726 | 5207227147005 | E | T8 | 24 | 6500 | 2640 | 28 x 1500 | 1498 | 0,285 | 1/25 | 10 |
| 180-77727 | 5207227147029 | F | T8 | 24 | 4000 | 2520 | 28 x 1500 | 1498 | 0,285 | 1/25 | 10 |

LED Starter

Voltage 90-265V 50\60Hz • Operating Temperature -30° / +45°C • Material Πλαστικό / Plastic

| Code | Barcode | Weight (kg) | Packing | MOQ |
|-----------|---------------|-------------|---------|-----|
| 147-02210 | 5207227033957 | 0,003 | 25/500 | 25 |





SMD 2835 **G5 T5**
60cm / 90cm / 120cm / 150cm

Voltage 175-265V 50\60Hz • Lifetime 50.000h • On\Off 20.000
Cover Frost • Starting Time 0.5 sec • Operating Temperature -30° / +45°C
Υλικό / Material Γυαλί & Πλαστική Βάση / Glass & Plastic Base

G5 Base

| | | | |
|-----------------------------------|----------------------------------|---------------------|-------------------------------|
| CRI Ra >80 | BEAM ANGLE 220° | NON DIMMABLE | 5 YEARS WARRANTY |
|-----------------------------------|----------------------------------|---------------------|-------------------------------|

| Code | Barcode | Energy Class | Type | Watt | Kelvin | Lumen | Dimension Ø (mm) † | Height (Edge-Edge) | Weight (kg) | Packing | MOQ |
|-----------|---------------|--------------|------|------|--------|-------|--------------------|--------------------|-------------|---------|-----|
| 147-77711 | 5207227288517 | D | T5 | 7 | 4000 | 945 | 18.5 x 562 | 548 | 0,066 | 1/25/50 | 25 |
| 147-77781 | 5207227332302 | D | T5 | 7 | 3000 | 945 | 18.5 x 562 | 548 | 0,066 | 1/25/50 | 25 |
| 147-77788 | 5207227332371 | C | T5 | 10 | 4000 | 1600 | 18.5 x 562 | 548 | 0,066 | 1/25/50 | 25 |
| 147-77789 | 5207227332388 | C | T5 | 10 | 3000 | 1600 | 18.5 x 562 | 548 | 0,066 | 1/25/50 | 25 |
| 147-77712 | 5207227288524 | C | T5 | 10 | 4000 | 1600 | 18.5 x 862 | 849 | 0,121 | 1/25/50 | 25 |
| 147-77782 | 5207227332319 | C | T5 | 10 | 3000 | 1600 | 18.5 x 862 | 849 | 0,121 | 1/25/50 | 25 |
| 147-77713 | 5207227288531 | C | T5 | 16 | 4000 | 2560 | 18.5 x 862 | 849 | 0,121 | 1/25/50 | 25 |
| 147-77783 | 5207227332326 | C | T5 | 16 | 3000 | 2560 | 18.5 x 862 | 849 | 0,121 | 1/25/50 | 25 |
| 147-77714 | 5207227288548 | C | T5 | 16 | 4000 | 2560 | 18.5 x 1158 | 1148 | 0,125 | 1/25/50 | 25 |
| 147-77784 | 5207227332333 | C | T5 | 16 | 3000 | 2560 | 18.5 x 1158 | 1148 | 0,125 | 1/25/50 | 25 |
| 147-77715 | 5207227288555 | C | T5 | 26 | 4000 | 4160 | 18.5 x 1158 | 1148 | 0,125 | 1/25/50 | 25 |
| 147-77785 | 5207227332340 | C | T5 | 26 | 3000 | 4160 | 18.5 x 1158 | 1148 | 0,125 | 1/25/50 | 25 |
| 147-77716 | 5207227288562 | C | T5 | 18 | 4000 | 2880 | 18.5 x 1462 | 1448 | 0,174 | 1/25/50 | 25 |
| 147-77786 | 5207227332357 | C | T5 | 18 | 3000 | 2880 | 18.5 x 1462 | 1448 | 0,174 | 1/25/50 | 25 |
| 147-77717 | 5207227288579 | C | T5 | 26 | 4000 | 4160 | 18.5 x 1462 | 1448 | 0,174 | 1/25/50 | 25 |
| 147-77787 | 5207227332364 | C | T5 | 26 | 3000 | 3900 | 18.5 x 1462 | 1448 | 0,174 | 1/25/50 | 25 |
| 147-77718 | 5207227363184 | C | T5 | 36 | 4000 | 5760 | 18.5 x 1462 | 1448 | 0,174 | 1/25/50 | 25 |

SMD 2835 **G5 T5**
60cm / 90cm / 120cm / 150cm

Voltage 175-265V 50\60Hz • Lifetime 25.000h • On\Off 40.000
Cover Frost • Starting Time 0.5 sec • Operating Temperature -30° / +45°C
Υλικό / Material Πλαστικό & Μεταλλικό/ Plastic & Metallic

G5 Base

| | | | |
|-----------------------------------|----------------------------------|---------------------|-------------------------------|
| CRI Ra >80 | BEAM ANGLE 220° | NON DIMMABLE | 3 YEARS WARRANTY |
|-----------------------------------|----------------------------------|---------------------|-------------------------------|

| Code | Barcode | Energy Class | Type | Watt | Kelvin | Lumen | Dimension Ø (mm) † | Height (Edge-Edge) | Weight (kg) | Packing | MOQ |
|-----------|---------------|--------------|------|------|--------|-------|--------------------|--------------------|-------------|---------|-----|
| 147-77701 | 5207227105814 | E | T5 | 9 | 4000 | 900 | 18.5 x 562 | 548 | 0,066 | 25/50 | 10 |
| 147-77704 | 5207227105845 | E | T5 | 14 | 4000 | 1400 | 18.5 x 862 | 849 | 0,121 | 1/25/50 | 10 |
| 147-77707 | 5207227105876 | E | T5 | 16 | 4000 | 1800 | 18.5 x 1158 | 1148 | 0,125 | 1/25/50 | 10 |
| 147-77710 | 5207227143175 | E | T5 | 22 | 4000 | 2600 | 18.5 x 1462 | 1448 | 0,174 | 1/25/50 | 10 |

PRO
SERIES



SMD LED TUBES



η επιλογή
των επαγγελματιών
the professionals' choice

100,000h
lifetime

160Lm/W
κορυφαία απόδοση
excellent performance

50%
οικονομία
energy saving

σε σύγκριση με τις T8 λάμπες LED
comparing with T8 SMD LED tubes



Νέας γενιάς SMD LED Tubes C-class ρίχνουν το φως τους στην οικονομία και τη διάρκεια αυτής! Ουσιαστική οικονομία 50% με ενεργειακή απόδοση 160Lm/W, και 100.000 ώρες ζωής θα φωτίζουν τα κέρδη της επιλογής σας για πολλά χρόνια!

New generation SMD LED Tubes C-class shine their light in the economy and its duration! Substantial savings of 50% with an energy efficiency of 160Lm/W, and 100,000 hours of life they will illuminate the earnings of your choice for many years!



**SMD
2835** **G10Q T9**



Voltage 170-250V 50\60Hz • Lifetime 25.000h • On\Off 50.000
 Cover Frost • Starting Time 0.5 sec • Operating Temperature -30° / +45°C
 Υλικό / Material Γυαλί & Πλαστική Βάση / Glass & Plastic Base

| | | | |
|--|----------------------------------|-------------------------------|---|
| CRI Ra >80 | BEAM ANGLE 270° | NON DIMMABLE | 2 YEARS WARRANTY |
|--|----------------------------------|-------------------------------|---|

| Code | Barcode | Energy Class | Type | Watt | Kelvin | Lumen | Dimension Ø (mm) † | Weight (kg) | Packing | MOQ |
|------------------|---------------|--------------|------|------|--------|-------|--------------------|-------------|---------|-----|
| 147-77792 | 5207227189685 | F | T9 | 18 | 4000 | 1850 | 300 x 30 | 0,317 | 1/10 | 1 |
| 147-77795 | 5207227189708 | F | T9 | 25 | 4000 | 2600 | 400 x 30 | 0,467 | 1/10 | 1 |



Διακοσμητικοί
Λαμπτήρες LED

Decor LED Lamps

CROSS filament A60 Gold



E27 Base



Voltage 220-240V 50\60Hz • Lifetime 25.000h • On\Off 25.000
 Cover Χρυσό / Gold • Starting Time 0.5 sec • Operating Temperature -30° / +45°C
 Υλικό Κατασκευής / Production Material Γυαλί & Βάση Αλουμινίου / Glass & Aluminium Base

| | | | |
|-----------------------------------|---------------------------|-----------------|-------------------------------|
| CRI Ra >90 | BEAM ANGLE 360° | DIMMABLE | 2 YEARS WARRANTY |
|-----------------------------------|---------------------------|-----------------|-------------------------------|

| Code | Barcode | Energy Class | Type | Watt | = Watt | Kelvin | Lumen | Dimension Ø (mm) † | Packing | MOQ |
|-----------|---------------|--------------|------|------|--------|--------|-------|-----------------------|---------|-----|
| 147-78760 | 5207227146701 | E | A60 | 7 | 60 | 2400 | 806 | 60 x 106 | 1/10/50 | 5 |

CROSS filament C37



E14 Base



Voltage 220-240V 50\60Hz • Lifetime 25.000h • On\Off 25.000
 Cover Χρυσό / Gold • Starting Time 0.5 sec • Operating Temperature -30° / +45°C
 Υλικό Κατασκευής / Production Material Γυαλί & Βάση Αλουμινίου / Glass & Aluminium Base

| | | | |
|-----------------------------------|---------------------------|-----------------|-------------------------------|
| CRI Ra >90 | BEAM ANGLE 360° | DIMMABLE | 2 YEARS WARRANTY |
|-----------------------------------|---------------------------|-----------------|-------------------------------|

| Code | Barcode | Energy Class | Type | Watt | = Watt | Kelvin | Lumen | Dimension Ø (mm) † | Packing | MOQ |
|-----------|---------------|--------------|------|------|--------|--------|-------|-----------------------|---------|-----|
| 147-78765 | 5207227175152 | F | C37 | 4.5 | 40 | 2400 | 480 | 35 x 98 | 1/10/50 | 5 |



filament ST64 / G95 / G125 Gold



E27 Base



Voltage 220-240V 50\60Hz • Lifetime 25.000h • On\Off 15.000
 Cover Χρυσό / Gold • Starting Time 0.5 sec • Operating Temperature -30° / +45°C
 Υλικό Κατασκευής / Production Material Γυαλί / Glass

| | | | |
|-----------------------------------|---------------------------|-----------------|-------------------------------|
| CRI Ra >80 | BEAM ANGLE 360° | DIMMABLE | 2 YEARS WARRANTY |
|-----------------------------------|---------------------------|-----------------|-------------------------------|

| Code | Barcode | Energy Class | Type | Watt | Amperage mA | Kelvin | Lumen | Dimension Ø (mm) † | Packing | MOQ |
|-----------|---------------|--------------|------|------|----------------|--------|-------|-----------------------|---------|-----|
| 147-78701 | 5207227114427 | G | ST64 | 5 | 35 | 2000 | 300 | 64 x 140 | 1\10\50 | 2 |
| 147-78702 | 5207227146749 | G | G95 | 5 | 28 | 1800 | 300 | 95 x 142 | 1\5\20 | 2 |
| 147-78703 | 5207227148705 | G | G125 | 5 | | 2000 | 300 | 125 x 170 | 1\5\20 | 5 |



filament **G95 / G125 Gold**

Voltage 220-240V 50\60Hz • Lifetime 25.000h • On\Off 25.000
 Cover Χρυσό / Gold • Starting Time 0.5 sec • Operating Temperature -30° / +45°C
 Υλικό Κατασκευής / Production Material Γυαλί & Βάση Αλουμινίου / Glass & Aluminium Base

| Code | Barcode | Energy Class | Type | Watt | = Watt | Kelvin | Lumen | Dimension Ø (mm) † | Packing | MOQ |
|-----------|---------------|--------------|------|------|--------|--------|-------|--------------------|---------|-----|
| 147-78770 | 5207227114458 | E | G95 | 8 | 75 | 2400 | 1055 | 95 x 142 | 1/5/20 | 5 |
| 147-78771 | 5207227114489 | E | G125 | 8 | 75 | 2400 | 1055 | 125 x 180 | 1/5/20 | 5 |



filament **ST64 Gold**

Voltage 220-240V 50\60Hz • Lifetime 25.000h • On\Off 25.000
 Cover Χρυσό / Gold • Starting Time 0.5 sec • Operating Temperature -30° / +45°C
 Υλικό Κατασκευής / Production Material Γυαλί & Βάση Αλουμινίου / Glass & Aluminium Base

| Code | Barcode | Energy Class | Type | Watt | = Watt | Kelvin | Lumen | Dimension Ø (mm) † | Packing | MOQ |
|-----------|---------------|--------------|------|------|--------|--------|-------|--------------------|---------|-----|
| 147-80930 | 5206139038982 | F | ST64 | 10 | 75 | 2500 | 1050 | 64 x 140 | 1/10/50 | 5 |



SMD **2835 G95 / Diamond - Gold Glass**

Voltage 220-240V 50\60Hz • Lifetime 25.000h • On\Off 25.000
 Cover Χρυσό / Gold • Starting Time 0.5 sec • Operating Temperature -30° / +45°C
 Υλικό Κατασκευής / Production Material Γυαλί & Ακρυλικό / Glass & Acrylic

| Code | Barcode | Energy Class | Type | Watt | Amperage mA | Kelvin | Lumen | Dimension Ø (mm) † | Packing | MOQ |
|-----------|---------------|--------------|---------|------|-------------|--------|-------|--------------------|---------|-----|
| 147-81823 | 5207227036774 | G | G125 | 3,5 | 56 | 2000 | 120 | 125 x 165 | 1\10 | 1 |
| 147-81824 | 5207227056185 | G | Diamond | 3,5 | 56 | 2000 | 120 | 125 x 175 | 1\10 | 1 |

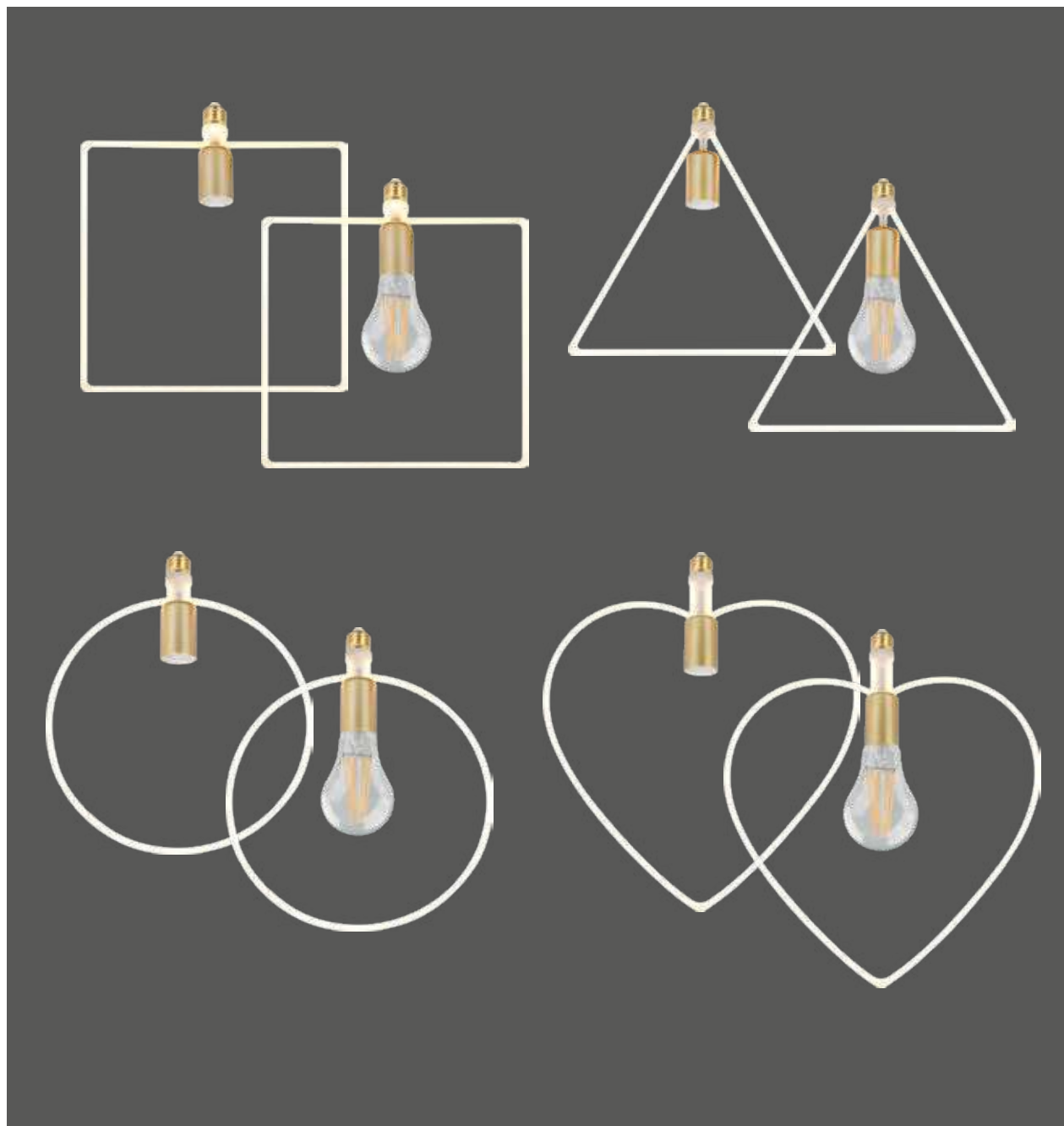

Περιλαμβάνει ντουί E27 για σύνδεση επιπλέον λαμπτήρα, ο οποίος δεν συμπεριλαμβάνεται στην συσκευασία.
Integrates E27 lampholder for extra lamp connection, which is not included in the package.

Soft filament **Shapes**

Voltage 220-240V 50\60Hz • Lifetime 25.000h • On\Off 25.000
Cover Frost • Starting Time 0.5 sec • Operating Temperature -30° / +45°C
Υλικό Κατασκευής / Production Material Πλαστικό / Plastic



E27 Base



CRI
Ra
>80

BEAM ANGLE
360°

DIMMABLE

2
YEARS
WARRANTY

| Code | Barcode | Energy Class | Type | Watt | Amperage mA | Kelvin | Lumen | Dimension (mm) | | | Packing | MOQ |
|-----------|---------------|--------------|----------|------|-------------|--------|-------|----------------|------|---|---------|-----|
| | | | | | | | | ↗ | ↔ | ↘ | | |
| 147-78721 | 5207227111556 | E | Square | 12 | 0,058 | 2700 | 1500 | 290 x 40 x 335 | 1\10 | 1 | | |
| 147-78722 | 5207227111570 | E | Triangle | 12 | 0,058 | 2700 | 1500 | 290 x 40 x 290 | 1\10 | 1 | | |
| 147-78723 | 5207227111594 | E | Circle | 12 | 0,058 | 2700 | 1500 | 350 x 40 x 415 | 1\10 | 1 | | |
| 147-78724 | 5207227111617 | E | Heart | 12 | 0,058 | 2700 | 1500 | 275 x 40 x 340 | 1\10 | 1 | | |



SMD 2835 G200 Gold Glass

Voltage 220-240V 50\60Hz • Lifetime 25.000h • On\Off 25.000
Cover Χρυσό / Gold • Starting Time 0.5 sec • Operating Temperature -30° / +45°C
Υλικό Κατασκευής / Production Material Γυαλί & Ακρυλικό / Glass & Acrylic



E27 Base

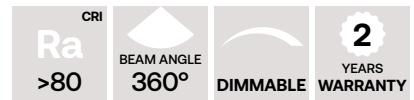

| Code | Barcode | Energy Class | Type | Watt | Amperage mA | Kelvin | Lumen | Dimension Ø (mm) † | Packing | MOQ |
|-----------|---------------|--------------|------|------|-------------|--------|-------|--------------------|---------|-----|
| 147-81830 | 5207227036798 | G | G200 | 3,5 | | 2000 | 120 | 200 x 241 | 1\4 | 1 |



SMD 2835 P165 Gold Glass

Voltage 220-240V 50\60Hz • Lifetime 25.000h • On\Off 25.000
Cover Χρυσό / Gold • Starting Time 0.5 sec • Operating Temperature -30° / +45°C
Υλικό Κατασκευής / Production Material Γυαλί & Ακρυλικό / Glass & Acrylic



E27 Base

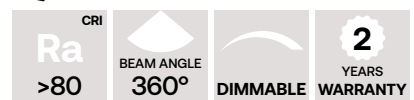

| Code | Barcode | Energy Class | Type | Watt | Amperage mA | Kelvin | Lumen | Dimension Ø (mm) † | Packing | MOQ |
|-----------|---------------|--------------|------|------|-------------|--------|-------|--------------------|---------|-----|
| 147-81832 | 5207227036804 | G | P165 | 3,5 | | 2000 | 120 | 165 x 303 | 1\4 | 1 |



147-78730



147-78731



147-78735

SMD
2835 **Smoky DNA**



E27 Base



Voltage 220-240V 50\60Hz • Lifetime 25.000h • On\Off 25.000
Cover Γκρι / Smoky • Starting Time 0.5 sec • Operating Temperature -30° / +45°C
Υλικό Κατασκευής / Production Material Γυαλί & Ακρυλικό / Glass & Acrylic

| | | | |
|-------------------------|---------------------------|----------|-------------------------------|
| CRI Ra >80 | BEAM ANGLE 360° | DIMMABLE | 2 YEARS WARRANTY |
|-------------------------|---------------------------|----------|-------------------------------|

| Code | Barcode | Type | Watt | Amperage mA | Kelvin | Lumen | Dimension Ø (mm) † | Packing | MOQ |
|------------------|---------------|------|------|----------------|--------|-------|-----------------------|---------|-----|
| 147-78730 | 5207227157103 | G125 | 4 | 56 | 1800 | 55 | 125 x 164 | 1\10 | 1 |
| 147-78731 | 5207227157127 | G125 | 4 | 56 | 1800 | 55 | 125 x 164 | 1\10 | 1 |
| 147-78735 | 5207227157141 | S125 | 4 | 56 | 1800 | 55 | 125 x 163 | 1\10 | 1 |



Vintage
Edison **A110**



E27 Base



Voltage 220-240V 50\60Hz • Lifetime 2.000h • On\Off 1.000
Cover Διάφανο / Clear • Operating Temperature -30°C / +45°C
Υλικό Κατασκευής / Production Material Γυαλί & Βάση Αλουμινίου / Glass & Aluminium Base

| | | |
|---------------------------|----------|-------------------------------|
| BEAM ANGLE 360° | DIMMABLE | 2 YEARS WARRANTY |
|---------------------------|----------|-------------------------------|

| Code | Barcode | Energy Class | Type | Watt | Lumen | Dimension Ø (mm) † | Packing | MOQ |
|------------------|---------------|-----------------|------|------|-------|-----------------------|---------|-----|
| 147-88244 | 5206139054081 | G | A110 | 60 | 250 | 110 x 235 | 1\8 | 2 |



SMD
2835 **Move me**

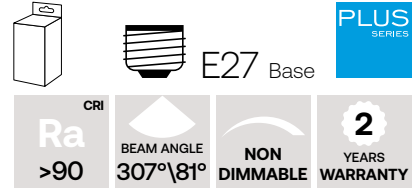

Voltage 220-240V 50\60Hz • Lifetime 25.000h • On\Off 25.000
Cover Διάφανο-Ασημί/Clear-Silver • Starting Time 0.5 sec • Operating Temperature -30° / +45°C
Υλικό Κατασκευής / Production Material Γυαλί & Αλουμίνιο / Glass & Aluminum

| Code | Barcode | Energy Class | Type | Watt | Amperage mA | Kelvin | Lumen | Dimension Ø (mm) † | Packing | MOQ |
|-----------|---------------|--------------|------|------|-------------|--------|-------|--------------------|---------|-----|
| 147-81890 | 5207227061776 | G | G120 | 5,5 | 24 | 2700 | 450 | 120 x 186 | 1\20 | 1 |

Ο λαμπτήρας δεν περιλαμβάνεται στη συσκευασία
The lamp is not included in the package

SMD
2835
Move me
Φωτιστικό Επιτραπέζιο
Table Luminaire



Voltage 220-240V 50\60Hz • Operating Temperature -10° / +45°C
Connection Φις / Plug • Μήκος Καλωδίου / Cable Length 150cm
Υλικό Κατασκευής / Production Material Πλαστικό & Χαλκός / Plastic & Copper

| Code | Barcode | Watt | Dimension Ø (mm) † | Packing | MOQ |
|-----------|---------------|-------------|--------------------|---------|-----|
| 147-81895 | 5207227083358 | MAX 10W LED | 170 x 95 | 1\20 | 1 |
| 147-81896 | 5207227083365 | MAX 10W LED | 160 x 60 | 1\20 | 1 |



Ο λαμπτήρας δεν περιλαμβάνεται στη συσκευασία
The lamp is not included in the package

SMD
2835
Move me
Φωτιστικό Κρεμαστό
Pendant Lunimaire



Voltage 220-240V 50\60Hz • Operating Temperature -10° / +45°C
Connection Κλέμμα / Terminal Block • Μήκος Καλωδίου / Cable Length 150cm
Υλικό Κατασκευής / Production Material Πλαστικό & Χαλκός / Plastic & Copper

| Code | Barcode | Watt | Dimension Ø (mm) † | Packing | MOQ |
|-----------|---------------|-------------|--------------------|---------|-----|
| 147-81897 | 5207227083372 | MAX 10W LED | 105 x 1500 | 1\20 | 1 |



filament A60 Ανεστραμμένου Καθρέπτη Crown Silver Mirror



E27 Base



Voltage 220-240V 50\60Hz • Lifetime 25.000h • On\Off 25.000
Cover Διάφανο / Clear • Starting Time 0,5 sec • Operating Temperature -30° / +45°C
Υλικό Κατασκευής / Production Material Γυαλί & Βάση Αλουμινίου / Glass & Aluminium Base



| Code | Barcode | Energy Class | Type | Watt | Kelvin | Lumen | Dimension Ø (mm) † | Packing | MOQ |
|-----------|---------------|--------------|------|------|--------|-------|--------------------|---------|-----|
| 147-80960 | 5206139035677 | F | A60 | 6 | 2700 | 650 | 60 x 106 | 1/10/50 | 5 |
| 147-78071 | 5207227408540 | E | A60 | 8 | 2700 | 900 | 60 x 106 | 1/10/50 | 5 |

filament G45 Ανεστραμμένου Καθρέπτη Crown Silver & Gold Mirror



E14 Base

| Code | Barcode | Energy Class | Type | Mirror | Watt | Kelvin | Lumen | Dimension Ø (mm) † | Packing | MOQ |
|-----------|---------------|--------------|------|--------|------|--------|-------|--------------------|---------|-----|
| 147-78073 | 5207227406577 | E | G45 | SILVER | 6,5 | 2700 | 806 | 45 x 72 | 1/10/50 | 5 |
| 147-78243 | 5207227408601 | E | G45 | GOLD | 6,5 | 2700 | 806 | 45 x 72 | 1/10/50 | 5 |

filament G95 Ανεστραμμένου Καθρέπτη Crown Silver Mirror



E27 Base

| Code | Barcode | Energy Class | Type | Watt | Kelvin | Lumen | Dimension Ø (mm) † | Packing | MOQ |
|-----------|---------------|--------------|------|------|--------|-------|--------------------|---------|-----|
| 147-78080 | 5207227408571 | E | G95 | 8 | 3000 | 900 | 95 x 138 | 1/10/50 | 5 |

- Με τον ανεστραμμένο καθρέπτη, προσφέρει ρυθμιζόμενο διάχυτο φως.
- Προσφέρει φωτεινό και με λιγότερο θάμπωμα φωτισμό, ανακλώντας το φως πίσω στο φωτιστικό με την επίστρωση της μισής λάμπας.
- Είναι ιδανικός για ανοιχτά ή κρεμαστά φωτιστικά.

- The dimmable mirror silver bulb offers diffused light.
- Offers bright and less glare lighting, by reflecting the light back to the fixture with its half coating.
- It is ideal for open fixtures, pendants.

Λαμπτήρες
Εξειδικευμένης
Χρήσης

Specialized Use Bulbs

Smart WiFi A60 - E27

Λαμπτήρες LED Smartlights Wi-Fi LED Lamps Smartlights Wi-Fi



Ρυθμίζεται μέσω εφαρμογής
Dimmable through app



E27 Base



Volt 220-240V 50/60Hz • Led Type SMD 2835 • Lifetime 25.000h • On/Off 25.000
Cover Ημιδιάφανο / Frost • Starting Time Instant Full Light • Operating Temperature -30° / +45°C
Υλικό / Material Πλαστικό με Ψύκτρα Αλουμινίου/ Plastic with Aluminium Heatsin

| | | | |
|---|----------------------------------|-----------------|---|
| CR Ra >80 | BEAM ANGLE 260° | DIMMABLE | 2 YEARS WARRANTY |
|---|----------------------------------|-----------------|---|

| Code | Barcode | Energy Class | Type | Watt | = Watt | Kelvin | Lumen | Dimension Ø (mm) † | Packing | MOQ |
|-----------|---------------|--------------|------|------|--------|-------------|-------|-----------------------|---------|-----|
| 147-77901 | 5207227076817 | F | A60 | 9 | 60 | RGBW | 850 | 60 x 110 | 1\10\50 | 5 |

Smart WiFi C37 - E14

Λαμπτήρες LED Smartlights Wi-Fi LED Lamps Smartlights Wi-Fi



Ρυθμίζεται μέσω εφαρμογής
Dimmable through app



E14 Base



Volt 220-240V 50/60Hz • Led Type SMD 2835 • Lifetime 25.000h • On/Off 25.000
Cover Ημιδιάφανο / Frost • Starting Time Instant Full Light • Operating Temperature -30° / +45°C
Υλικό / Material Πλαστικό με Ψύκτρα Αλουμινίου/ Plastic with Aluminium Heatsin

| | | | |
|---|----------------------------------|-----------------|---|
| CR Ra >80 | BEAM ANGLE 260° | DIMMABLE | 2 YEARS WARRANTY |
|---|----------------------------------|-----------------|---|

| Code | Barcode | Energy Class | Type | Watt | = Watt | Kelvin | Lumen | Dimension Ø (mm) † | Packing | MOQ |
|-----------|---------------|--------------|------|------|--------|-------------|-------|-----------------------|---------|-----|
| 147-77902 | 5207227076824 | F | C37 | 6 | 40 | RGBW | 470 | 39 x 115 | 1\10\50 | 5 |

Smart WiFi GU10

Λαμπτήρες LED Smartlights Wi-Fi LED Lamps Smartlights Wi-Fi



Ρυθμίζεται μέσω εφαρμογής
Dimmable through app



GU10 Base



Volt 220-240V 50/60Hz • Led Type SMD 2835 • Lifetime 25.000h • On/Off 25.000
Cover Ημιδιάφανο / Frost • Starting Time Instant Full Light • Operating Temperature -30° / +45°C
Υλικό / Material Πλαστικό με Ψύκτρα Αλουμινίου/ Plastic with Aluminium Heatsin

| | | | |
|---|----------------------------------|-----------------|---|
| CR Ra >80 | BEAM ANGLE 120° | DIMMABLE | 2 YEARS WARRANTY |
|---|----------------------------------|-----------------|---|

| Code | Barcode | Energy Class | Type | Watt | = Watt | Kelvin | Lumen | Dimension Ø (mm) † | Packing | MOQ |
|-----------|---------------|--------------|------|------|--------|-------------|-------|-----------------------|----------|-----|
| 147-77903 | 5207227076831 | G | GU10 | 6 | 40 | RGBW | 470 | 50 x 55 | 1\10\100 | 5 |

SMD
5730

A70
Με Ηλιακό Πάνελ
Built-in Solar Panels



E27 Base



Voltage 85-265V 50\60Hz • Lifetime 25.000h • On\Off 25.000
Cover Ημιδιάφανο / Frost • Starting Time 0.5 sec • Operating Temperature -30° / +45°C
Υλικό Κατασκευής / Production Material Πλαστικό - PP / Plastic - PP

| | | | | |
|------|-------------------------|---------------------------|-----------------|-------------------------------|
| IP65 | CRI Ra >80 | BEAM ANGLE 230° | NON DIMMABLE | 2 YEARS WARRANTY |
|------|-------------------------|---------------------------|-----------------|-------------------------------|

| Code | Barcode | Type | Watt | Kelvin | Lumen | Dimension Ø (mm) † | Packing | MOQ |
|-----------|---------------|------|------|--------|-------|-----------------------|----------|-----|
| 145-20003 | 5207227033025 | A70 | 7 | 6500 | 630 | 70 x 130 | 1/10/100 | 5 |

ΛΕΙΤΟΥΡΓΙΕΣ

- Διαθέτει τρεις ηλιακούς συλλέκτες. Φορτίζει στο ηλιακό φως για 8-9 ώρες ώστε να δώσει φωτισμό για 2-3 ώρες.
- Ο ηλιακός λαμπτήρας λειτουργεί όπως ένας κοινός λαμπτήρας, ενώ φορτίζεται ταυτόχρονα. Χρειάζεται 4-5 ώρες για να φορτίσει πλήρως, και σας δίνει 5 ώρες φωτισμού με την μπαταρία, σε περίπτωση διακοπής ρεύματος (ο διακόπτης πρέπει να είναι ενεργοποιημένος).

FUNCTIONS

- Fitted with three Solar Panels. The bulb will change in sunlight for 8-9 hours, and give 2-3 hours of lighting.
- The solar bulb operates like any common light bulb and charges at the same time. 4-5 hours are needed for full charge, and gives 5 hours of lighting with the battery, in case of power outage (the switch must be turned on).

ΕΦΑΡΜΟΓΕΣ

- Φορητός Φωτισμός
- Εφεδρικός Φωτισμός
- Φωτισμός Μικρών Εσωτερικών Χώρων
- Φωτισμός για Κήπο ή Βεράντα

APPLICATIONS

- Portable Lighting
- Emergency Lighting
- Small Indoor Lighting
- Garden or Porch Lighting

SMD
2835

Με Αισθητήρα Κίνησης
Motion Detector



E27 Base



Voltage 170-265V 50\60Hz • Lifetime 30.000h • On\Off 25.000
Cover Ημιδιάφανο / Frost • Starting Time 0.5 sec • Operating Temperature -30° / +45°C
Υλικό / Material Πλαστικό με Ψύκτρα Αλουμινίου / Plastic with Aluminium Heatsink

| | | | |
|-------------------------|---------------------------|-----------------|-------------------------------|
| CRI Ra >80 | BEAM ANGLE 180° | NON DIMMABLE | 2 YEARS WARRANTY |
|-------------------------|---------------------------|-----------------|-------------------------------|

| Code | Barcode | Energy Class | Type | Watt | = Watt | Kelvin | Lumen | Dimension Ø (mm) † | Packing | MOQ |
|-----------|---------------|--------------|------|------|--------|--------|-------|-----------------------|---------|-----|
| 147-84936 | 5207227057397 | F | A60 | 12 | 75 | 4000 | 1055 | 60 x 120 | 1/10/50 | 5 |

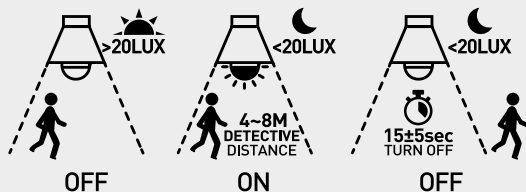

- Ανάβει αυτόματα όταν εντοπίσει κίνηση (4-8μ εύρος), και το φως του περιβάλλοντα χώρου είναι κάτω από 20 LUX. Παραμένει αναμμένος για 15 sec, αφού εντοπίσει κίνηση.
- Lights up automatically when the sensor detects motion (4-8m range) and the room light is below 20 LUX. Remains lighten for 15 sec after detecting movement.

SMD
2835

RGBW
Με Τηλεχειριστήριο
With Remote Control



E27 Base



Voltage 220-240V 50\60Hz • Lifetime 25.000h • On\Off 25.000
Cover Ημιδιάφανο / Frost • Starting Time 0.5 sec • Operating Temperature -30° / +45°C
Υλικό / Material Πλαστικό με Ψύκτρα Αλουμινίου/Plastic with Aluminium Heatsink



| Code | Barcode | Energy Class | Type | Watt | = Watt | Kelvin | Lumen | Dimension Ø (mm) † | Packing | MOQ |
|-----------|---------------|--------------|------|------|--------|--------|-------|--------------------|---------|-----|
| 147-77906 | 5207227175145 | F | A60 | 9 | 60 | RGBW | 850 | 60 x 110 | 1/6/24 | 6 |

filament

Με Αισθητήρα Ημέρας Νύχτας
Day Night Sensor



Ανάβει αυτόματα όταν το φως του περιβάλλοντα χώρου είναι κάτω από 20 LUX. Lights up automatically when the room light is below 20 LUX.



E27 Base



Voltage 220-240V 50\60Hz • Lifetime 25.000h • On\Off 25.000
Cover Διάφανο / Clear • Starting Time 0.5 sec • Operating Temperature -30° / +45°C
Υλικό / Material Γυαλί & Βάση Αλουμινίου / Glass & Aluminium Base



| Code | Barcode | Energy Class | Type | Watt | = Watt | Kelvin | Lumen | Dimension Ø (mm) † | Packing | MOQ |
|-----------|---------------|--------------|------|------|--------|--------|-------|--------------------|---------|-----|
| 147-78990 | 5207227117398 | E | A60 | 7 | 60 | 3000 | 806 | 60 x 106 | 1/10/50 | 5 |

SMD
2835

Με Αισθητήρα Ημέρας Νύχτας
Day Night Sensor



Ανάβει αυτόματα όταν το φως του περιβάλλοντα χώρου είναι κάτω από 20 LUX. Lights up automatically when the room light is below 20 LUX.



E27 Base



Voltage 170-265V 50\60Hz • Lifetime 30.000h • On\Off 25.000
Cover Ημιδιάφανο / Frost • Starting Time 0.5 sec • Operating Temperature -30° / +45°C
Υλικό / Material Πλαστικό με Ψύκτρα Αλουμινίου / Plastic with Aluminium Heatsink



| Code | Barcode | Energy Class | Type | Watt | = Watt | Kelvin | Lumen | Dimension Ø (mm) † | Packing | MOQ |
|-----------|---------------|--------------|------|------|--------|--------|-------|--------------------|---------|-----|
| 147-84931 | 5207227059001 | F | A60 | 10 | 70 | 4000 | 900 | 60 x 112 | 1/10/50 | 5 |

SMD
2835

Εντομοαπωθητικός
Insect Repellent



Voltage 220-240V 50\60Hz • Lifetime 25.000h • On\Off 25.000
Cover Κίτρινο / Yellow • Starting Time 0.5 sec • Operating Temperature -30° / +45°C
Υλικό / Material Πλαστικό με Ψύκτρα Αλουμινίου / Plastic with Aluminium Heatsink



| Code | Barcode | Type | Watt | Color | Dimension Ø (mm) † | Packing | MOQ |
|-----------|---------------|------|------|------------------|-----------------------|---------|-----|
| 147-80981 | 5207227011290 | A60 | 7 | KITPINO / YELLOW | 60 x 112 | 1/10/50 | 10 |

SMD
2835

Black Light



Voltage 220-240V 50\60Hz • Lifetime 25.000h • On\Off 25.000
Cover Ημιδιάφανο / Frost • Starting Time 0.5 sec • Operating Temperature -30° / +45°C
Υλικό / Material Πλαστικό με Ψύκτρα Αλουμινίου / Plastic with Aluminium Heatsink



| Code | Barcode | Type | Watt | Color | Dimension Ø (mm) † | Packing | MOQ |
|-----------|---------------|------|------|-------------|-----------------------|---------|-----|
| 147-84940 | 5207227058141 | A60 | 6 | ULTRAVIOLET | 60 x 111 | 1/10/50 | 5 |

Οδηγίες Συνδεσμολογίας
Connection Instruction

230V~50Hz

5mm
10mm

OFF

ON

(L) (GB) Live: brown wire (GR) Φάση: καφέ καλώδιο

(N) (GB) Neutral: blue wire (GR) Ουδέτερο : μπλε καλώδιο

Cable Type H03VV-F
Cable Length 0,15m
Cable Cross Section 2x0.75mm

NEW

SMD
2835

Με Καλώδιο και Κλέμμα
With Cable and Terminal Block



Voltage 220-240V 50\60Hz • Lifetime 25.000h • On\Off 25.000
Cover Ημιδιάφανο/Frost • Starting Time Instant Full Light • Operating Temperature -30° / +45°C
Υλικό / Material Πλαστικό με Ψύκτρα Αλουμινίου / Plastic with Aluminium Heatsink

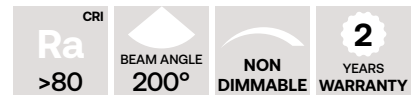

| Code | Barcode | Energy Class | Type | Watt | = Watt | Kelvin | Lumen | Dimension Ø (mm) † | Packing | MOQ |
|-----------|---------------|--------------|------|------|--------|--------|-------|-----------------------|---------|-----|
| 147-77520 | 5207227451379 | E | A60 | 9 | 65 | 4000 | 1000 | 60 x 108 | 1\10\50 | 10 |

SMD
2835



Λαμπτήρας Ανάπτυξης Φυτών με DIP Διακόπτη Plant grow light with DIP switch

- Ρυθμιζόμενο φάσμα για σπορά, βλαστική ανάπτυξη και άνθηση (με διακόπτη DIP).
- Adjustable spectrum for seeding, vegetative growth, and flowering (with DIP switch).

Χαρακτηριστικά - Features

- Εκπέμπει Φάσματα Μήκους Κύματος και Χρώματος για Φωτοσυνθετική Απόκριση / Emits Spectrum Wavelengths and Color for Photosynthetic Response
- Κατάλληλο για Υγρά Περιβάλλοντα / Suitable for Damp Locations
- Κατάλληλο για Χρήση σε Υψηλή Υγρασία / Rated for High Humidity Use
- Μη Ντιμαριζόμενο / Non-Dimmable
- Χωρίς Υδράργυρο / 100% Mercury Free
- Εγγύηση 2 Ετών / 2 Year Warranty

Οφέλη / Benefits

- Χαμηλή Εκπομπή Θερμότητας και Χαμηλή Κατανάλωση Ενέργειας / Low Heat Emission and Low Energy Consumption
- Ρυθμιζόμενο Φάσμα για Σπορά, Ανάπτυξη και Ανθοφορία / Adjustable Spectrum for Seeding, Vegetative Growth and Flowering
- Λειτουργία Λάμπας σε Χαμηλότερη Θερμοκρασία Διατηρεί την Υγρασία στα Φυτά ενώ Αποτρέπει την Καύση της Λάμπας / Cooler Lamp Operation Retains Moisture in Plants while Preventing Lamp Burn



Ξεκίνα

Get Started

Από τον σπόρο στη σπορά
Seed to Seeding



Normalized Photon Flux: White+Blue

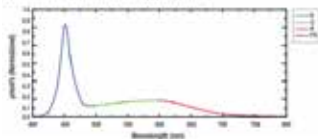

Άρχισε να αναπτύσσεσαι

Get Growing

Ανάπτυξη λαχανικών
Vegetable Growth

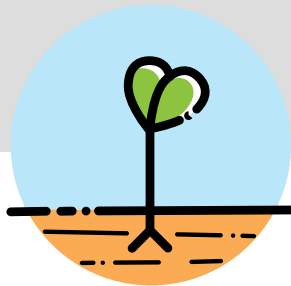

Normalized Photon Flux: White

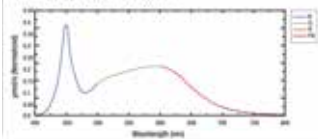

Άρχισε να ανθίζεις

Get Blooming

Ανθοφορία και καρποφορία
Flowering and Fruiting

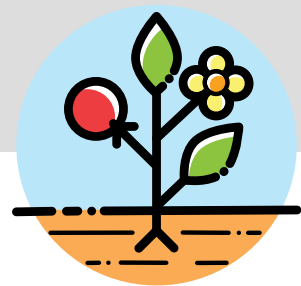

Normalized Photon Flux: White+Red

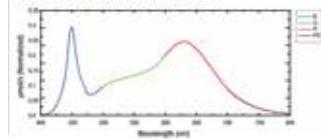

E27 Base



Voltage 220-240V 50\60Hz • Lifetime 30.000h • On/Off 25.000
Cover Διάφανο / Clear • Starting Time 0.5 sec • Operating Temperature -30° / +45°C
Υλικό / Material Πλαστικό με Ψύκτρα Αλουμινίου / Plastic with Aluminium Heatsink

CRI
Ra
>50

BEAM ANGLE
160°

NON
DIMMABLE

2
YEARS
WARRANTY

| Code | Barcode | Type | Watt | = Watt | Dimension Ø (mm) ‡ | Packing | MOQ |
|-----------|---------------|------|------|--------|-----------------------|---------|-----|
| 147-84932 | 5207227411014 | A60 | 9 | 44 | 60 x 116 | 1/10/50 | 10 |



SMD 2835 Λαμπτήρας Ψυγείου Refrigerator Lamp



E14 Base



Voltage 220-240V 50\60Hz • Lifetime 25.000h • On\Off 25.000
 Cover Ημιδιάφανο / Frost • Starting Time 0.5 sec • Operating Temperature -30° / +45°C
 Υλικό / Material Πλαστικό με Ψύκτρα Αλουμινίου/Plastic with Aluminium Heatsink

| | | | |
|-------------------------|---------------------------|-----------------|-------------------------------|
| CRI Ra >80 | BEAM ANGLE 150° | NON DIMMABLE | 2 YEARS WARRANTY |
|-------------------------|---------------------------|-----------------|-------------------------------|

| Code | Barcode | Energy Class | Type | Watt | = Watt | Kelvin | Lumen | Dimension Ø (mm) † | Packing | MOQ |
|-----------|---------------|--------------|------|------|--------|--------|-------|-----------------------|----------|-----|
| 147-82800 | 5206139076656 | G | T22 | 1 | 10 | 2700 | 70 | 23 x 50 | 1/10/200 | 10 |

SMD 2835 Λαμπτήρας Ψυγείου Refrigerator Lamp



E14 Base



Voltage 220-240V 50\60Hz • Lifetime 25.000h • On\Off 25.000
 Cover Ημιδιάφανο / Frost • Starting Time 0.5 sec • Operating Temperature -30° / +45°C
 Υλικό / Material Πλαστικό με Ψύκτρα Αλουμινίου/Plastic with Aluminium Heatsink

| | | | |
|-------------------------|---------------------------|-----------------|-------------------------------|
| CRI Ra >80 | BEAM ANGLE 330° | NON DIMMABLE | 2 YEARS WARRANTY |
|-------------------------|---------------------------|-----------------|-------------------------------|

| Code | Barcode | Energy Class | Type | Watt | = Watt | Kelvin | Lumen | Dimension Ø (mm) † | Packing | MOQ |
|-----------|---------------|--------------|------|------|--------|--------|-------|-----------------------|----------|-----|
| 147-82801 | 5207227037337 | F | T16 | 3 | 30 | 2700 | 260 | 16 x 52 | 1/10/200 | 10 |

SMD 2835 Λαμπτήρας Νυκτός Night Lamp



E14 Base



Voltage 220-240V 50\60Hz • Lifetime 25.000h • On\Off 25.000
 Cover Frost - Red - Yellow • Starting Time 0.5 sec • Operating Temperature -30° / +45°C
 Υλικό / Material Πλαστικό με Ψύκτρα Αλουμινίου/Plastic with Aluminium Heatsink

| | | | |
|-------------------------|---------------------------|-----------------|-------------------------------|
| CRI Ra >80 | BEAM ANGLE 150° | NON DIMMABLE | 2 YEARS WARRANTY |
|-------------------------|---------------------------|-----------------|-------------------------------|

| Code | Barcode | Energy Class | Type | Watt | = Watt | Kelvin | Lumen | Dimension Ø (mm) † | Packing | MOQ |
|-----------|---------------|--------------|------|------|--------|--------|-------|-----------------------|----------|-----|
| 147-82820 | 5207227014918 | G | T22 | 1.5 | 10 | 2700 | 70 | 23 x 50 | 1/20/200 | 10 |
| 147-82822 | 5207227015007 | G | T22 | 1.5 | 10 | RED | | 23 x 50 | 1/20/200 | 10 |
| 147-82823 | 5207227015090 | G | T22 | 1.5 | 10 | YELLOW | | 23 x 50 | 1/20/200 | 10 |



SMD
2835 PAR30



E27 Base



Voltage 220-240V 50\60Hz • Lifetime 25.000h • On\Off 25.000
Cover Διάφανο / Clear • Starting Time 0.5 sec • Operating Temperature -30° / +45°C
Υλικό / Material Πλαστικό με Ψύκτρα Αλουμινίου/ Plastic with Aluminium Heatsink

CRI **Ra >80** BEAM ANGLE **40°** DIMMABLE **2 YEARS WARRANTY**

| Code | Barcode | Energy Class | Type | Watt | Kelvin | Lumen | Dimension Ø (mm) † | Packing | MOQ |
|-----------|---------------|--------------|-------|------|--------|-------|--------------------|---------|-----|
| 147-77551 | 5207227074585 | F | PAR30 | 15 | 4000 | 1300 | 95 x 92 | 1/10/50 | 5 |
| 147-77552 | 5207227074615 | F | PAR30 | 15 | 2700 | 1300 | 95 x 92 | 1/10/50 | 5 |

SMD
2835 AR111



G53 Base



Voltage 12V AC/DC 50\60Hz • Lifetime 25.000h • On\Off 25.000
Cover Διάφανο / Clear • Starting Time 0.5 sec • Operating Temperature -30° / +45°C
Υλικό / Material Πλαστικό με Ψύκτρα Αλουμινίου/ Plastic with Aluminium Heatsink

CRI **Ra >80** BEAM ANGLE **24°** NON DIMMABLE **2 YEARS WARRANTY**

| Code | Barcode | Energy Class | Type | Watt | Kelvin | Lumen | Dimension Ø (mm) † | Packing | MOQ |
|-----------|---------------|--------------|-------|------|--------|-------|--------------------|---------|-----|
| 147-77681 | 5207227072987 | F | AR111 | 12 | 4000 | 1050 | 111 x 71 | 1/10/50 | 10 |

SMD
2835 AR111



GU10 Base



Voltage 220-240V 50\60Hz • Lifetime 25.000h • On\Off 25.000
Cover Διάφανο / Clear • Starting Time 0.5 sec • Operating Temperature -30° / +45°C
Υλικό / Material Πλαστικό με Ψύκτρα Αλουμινίου/ Plastic with Aluminium Heatsink

CRI **Ra >80** BEAM ANGLE **24°** NON DIMMABLE **2 YEARS WARRANTY**

| Code | Barcode | Energy Class | Type | Watt | Kelvin | Lumen | Dimension Ø (mm) † | Packing | MOQ |
|-----------|---------------|--------------|-------|------|--------|-------|--------------------|---------|-----|
| 147-77684 | 5207227072994 | F | AR111 | 12 | 4000 | 1050 | 111 x 71 | 1/10/50 | 5 |

SMD
2835 PAR38



E27 Base



Voltage 170-240V 50\60Hz • Lifetime 30.000h • On\Off 25.000
Cover Διάφανο / Clear • Starting Time 0.5 sec • Operating Temperature -30° / +45°C
Υλικό / Material Γυαλί & Βάση Αλουμινίου / Glass & Aluminium Base

IP65 CRI Ra >80 BEAM ANGLE 45° NON DIMMABLE 2 YEARS WARRANTY

| Code | Barcode | Energy Class | Type | Watt | = Watt | Kelvin | Lumen | Dimension Ø (mm) † | Packing | MOQ |
|-----------|---------------|--------------|-------|------|--------|--------|-------|--------------------|---------|-----|
| 147-77560 | 5207227114755 | F | PAR38 | 15 | | 6500 | 1320 | 122 x 133 | 1/12 | 4 |
| 147-77561 | 5207227114779 | F | PAR38 | 15 | | 4000 | 1320 | 122 x 133 | 1/12 | 4 |
| 147-77562 | 5207227114793 | F | PAR38 | 15 | | 3000 | 1320 | 122 x 133 | 1/12 | 4 |
| 147-77563 | 5207227114816 | - | PAR38 | 15 | | GREEN | - | 122 x 133 | 1/12 | 4 |
| 147-77564 | 5207227114830 | - | PAR38 | 15 | | BLUE | - | 122 x 133 | 1/12 | 4 |

Voltage 42V AC/DC 50\60Hz

| Code | Barcode | Energy Class | Type | Watt | = Watt | Kelvin | Lumen | Dimension Ø (mm) † | Packing | MOQ |
|-----------|---------------|--------------|-------|------|--------|--------|-------|--------------------|---------|-----|
| 147-77566 | 5207227114854 | G | PAR38 | 15 | | 4000 | 1320 | 122 x 133 | 1/12 | 4 |
| 147-77568 | 5207227114878 | - | PAR38 | 15 | | GREEN | - | 122 x 133 | 1/12 | 4 |

SMD
2835

PAR56
Λαμπτήρας LED
για φωτιστικά πισίνας
Led Lamps for pool lights

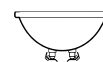

PAR56 Base



Voltage 12V AC/DC 50\60Hz • Lifetime 30.000h • On\Off 15.000
Cover Διάφανο / Clear • Starting Time 0.1 sec • Operating Temperature -30° / +50°C
Υλικό / Material Γυαλί & Βάση Αλουμινίου / Glass & Aluminium Base

IP68 CRI Ra >80 BEAM ANGLE 90° NON DIMMABLE 2 YEARS WARRANTY

| Code | Barcode | Energy Class | Type | Watt | = Watt | Kelvin | Lumen | Dimension Ø (mm) † | Packing | MOQ |
|-----------|---------------|--------------|-------|------|--------|--------|-------|--------------------|---------|-----|
| 147-77570 | 5207227153501 | F | PAR56 | 20 | | 6500 | 1900 | 178 x 114 | 1/12 | 1 |
| 147-77571 | 5207227153525 | F | PAR56 | 20 | | 3000 | 1800 | 178 x 114 | 1/12 | 1 |
| 147-84573 | 5206139042477 | | PAR56 | 20 | | RGB | - | 178 x 114 | 1/12 | 1 |

Χειριστήριο & διακόπτης για PAR56
Controller and switch for PAR56



Voltage 220-240V 50\60Hz • Operating Temperature -30° / +50°C
Υλικό / Material Πλαστικό / Plastic

IP20 2 YEARS WARRANTY



| Code | Barcode | Dimension (mm) | Packing | MOQ |
|-----------|---------------|----------------|---------|-----|
| 147-77575 | 5207227153976 | 75x45x30mm | 1/50 | 1 |





Λαμπτήρες LED SMD
Βιομηχανικής &
Επαγγελματικής
Χρήσης

Industrial &
Professional Use
LED SMD Lamps

SMD 2835 SL - E27



Voltage 170-250V 50\60Hz • Lifetime 40.000h • On\Off 50.000
 Cover Πρισματικό / Prismatic • Starting Time 0.5 sec • Oper. Temperature -30° / +45°C
 Material Αλουμίνιο & Πλαστικό με Πρισματικό Κάλυμμα & Διαχύτη / Aluminium & Plastic with Prismatic Cover & Diffuser

| Code | Barcode | Energy Class | Type | Watt | Kelvin | Lumen | Dimension Ø (mm) † | Packing | MOQ |
|-----------|---------------|--------------|------|------|--------|-------|--------------------|---------|-----|
| 147-76500 | 5207227063916 | F | SL | 15 | 6500 | 1500 | 65 x 149 | 1/10/50 | 10 |
| 147-76501 | 5207227063947 | F | SL | 15 | 4000 | 1500 | 65 x 149 | 1/10/50 | 10 |
| 147-76502 | 5207227063978 | F | SL | 15 | 2700 | 1500 | 65 x 149 | 1/10/50 | 10 |
| 147-76506 | 5207227064005 | F | SL | 20 | 6500 | 2000 | 65 x 169 | 1/10/50 | 10 |
| 147-76507 | 5207227064036 | F | SL | 20 | 4000 | 2000 | 65 x 169 | 1/10/50 | 10 |
| 147-76508 | 5207227064067 | F | SL | 20 | 2700 | 2000 | 65 x 169 | 1/10/50 | 10 |



SMD 2835 Hammer T80 - E27

Voltage 100-277V 50\60Hz • Lifetime 40.000h • On\Off 50.000
 Cover Frost • Starting Time 0.5 sec • Operating Temperature -30° / +45°C
 Material Πλαστικό με Ψύκτρα Αλουμινίου / Plastic with Aluminium Heatsink

| Code | Barcode | Energy Class | Type | Watt | Kelvin | Lumen | Dimension Ø (mm) † | Packing | MOQ |
|-----------|---------------|--------------|------|------|--------|-------|--------------------|---------|-----|
| 147-76530 | 5207227104640 | E | T80 | 16 | 6500 | 1760 | 80 x 136 | 1/40 | 10 |
| 147-76531 | 5207227104664 | E | T80 | 16 | 4000 | 1760 | 80 x 136 | 1/40 | 10 |
| 147-76532 | 5207227111150 | E | T80 | 16 | 2700 | 1760 | 80 x 136 | 1/40 | 10 |



SMD 2835 FAN E27

Voltage 185-265V 50\60Hz • Lifetime 25.000h • On\Off 25.000
 Cover Frost • Starting Time 0.5 sec • Operating Temperature -30° / +45°C
 Material Πλαστικό με Ψύκτρα Αλουμινίου / Plastic with Aluminium Heatsink

| Code | Barcode | Energy Class | Type | Watt | Kelvin | Lumen | Dimension Ø (mm) † | Packing | MOQ |
|-----------|---------------|--------------|------|------|--------|-------|--------------------|---------|-----|
| 147-76601 | 5207227099687 | F | FAN | 40 | 4000 | 4600 | 374 x 85 | 1/25 | 1 |

SMD 2835 Hammer T80 / T100 / T118 - E27



E27 Base



Voltage 100-277V 50\60Hz • Lifetime 40.000h • On\Off 50.000
 Cover Frost • Starting Time 0.5 sec • Operating Temperature -30° / +45°C
 Material Πλαστικό με Ψύκτρα Αλουμινίου / Plastic with Aluminium Heatsink



| Code | Barcode | Energy Class | Type | Watt | Kelvin | Lumen | Dimension Ø (mm) † | Packing | MOQ |
|-----------|---------------|--------------|------|------|--------|-------|--------------------|---------|-----|
| 147-76539 | 5207227111174 | F | T80 | 30 | 6500 | 3000 | 80 x 150 | 1/20 | 5 |
| 147-76540 | 5207227111198 | F | T80 | 30 | 4000 | 3000 | 80 x 150 | 1/20 | 5 |
| 147-76545 | 5207227064326 | F | T100 | 40 | 6500 | 4000 | 100 x 180 | 1/20 | 5 |
| 147-76546 | 5207227064333 | F | T100 | 40 | 4000 | 4000 | 100 x 180 | 1/20 | 5 |
| 147-76548 | 5207227111211 | F | T118 | 50 | 6500 | 5000 | 118 x 198 | 1/12 | 2 |
| 147-76549 | 5207227104695 | F | T118 | 50 | 4000 | 5000 | 118 x 198 | 1/12 | 2 |

Hammer T135 - E40/E27



| Code | Barcode | Energy Class | Type | Watt | Kelvin | Lumen | Dimension Ø (mm) † | Packing | MOQ |
|-----------|---------------|--------------|------|------|--------|-------|--------------------|---------|-----|
| 147-76551 | 5207227104718 | F | T135 | 100 | 6500 | 10000 | 135 x 277 | 1/8 | 2 |
| 147-76552 | 5207227111235 | F | T135 | 100 | 4000 | 10000 | 135 x 277 | 1/8 | 2 |



Hammer T230 - E40/E27



| Code | Barcode | Energy Class | Type | Watt | Kelvin | Lumen | Dimension Ø (mm) † | Packing | MOQ |
|-----------|---------------|--------------|------|------|--------|-------|--------------------|---------|-----|
| 147-76557 | 5207227104732 | D | T230 | 125 | 6500 | 18750 | 230 x 306 | 1/4 | 2 |
| 147-76558 | 5207227111259 | D | T230 | 125 | 4000 | 18750 | 230 x 306 | 1/4 | 2 |

SMD
2835

MAGNOLIA E27



Voltage 180-265V 50\60Hz • Lifetime 40.000h • On\Off 50.000
Cover Frost • Starting Time 0.5 sec • Operating Temperature -30° / +45°C
Material Πλαστικό με Ψύκτρα Αλουμινίου / Plastic with Aluminium Heatsink

IP65 CRI Ra >80 BEAM ANGLE 360° NON DIMMABLE 2 YEARS WARRANTY

| Code | Barcode | Energy Class | Type | Watt | Kelvin | Lumen | Dimension Ø (mm) † | Packing | MOQ |
|-----------|---------------|--------------|----------|------|--------|-------|--------------------|---------|-----|
| 147-76010 | 5207227063718 | E | Magnolia | 30 | 6500 | 3450 | 90 x 218 | 1/25 | 2 |
| 147-76011 | 5207227063725 | E | Magnolia | 30 | 4000 | 3450 | 90 x 218 | 1/25 | 2 |
| 147-76012 | 5207227063732 | E | Magnolia | 30 | 2700 | 3450 | 90 x 218 | 1/25 | 2 |
| 147-76013 | 5207227063749 | E | Magnolia | 40 | 6500 | 4600 | 90 x 218 | 1/25 | 2 |
| 147-76014 | 5207227063756 | E | Magnolia | 40 | 4000 | 4600 | 90 x 218 | 1/25 | 2 |
| 147-76015 | 5207227063763 | E | Magnolia | 40 | 2700 | 4600 | 90 x 218 | 1/25 | 2 |
| 147-76020 | 5207227059728 | E | Magnolia | 50 | 6500 | 5750 | 90 x 218 | 1/25 | 2 |
| 147-76021 | 5207227059742 | E | Magnolia | 50 | 4000 | 5750 | 90 x 218 | 1/25 | 2 |
| 147-76022 | 5207227063787 | E | Magnolia | 50 | 2700 | 5750 | 90 x 218 | 1/25 | 2 |

SMD
2835

MAGNOLIA E40



E40 Base

| Code | Barcode | Energy Class | Type | Watt | Kelvin | Lumen | Dimension Ø (mm) † | Packing | MOQ |
|-----------|---------------|--------------|----------|------|--------|-------|--------------------|---------|-----|
| 147-76017 | 5207227174698 | E | Magnolia | 40 | 6500 | 4600 | 90 x 218 | 1/10 | 2 |
| 147-76018 | 5207227142383 | E | Magnolia | 40 | 4000 | 4600 | 90 x 218 | 1/10 | 2 |
| 147-76023 | 5207227063800 | E | Magnolia | 60 | 6500 | 6300 | 120 x 285 | 1/10 | 2 |
| 147-76024 | 5207227060915 | E | Magnolia | 60 | 4000 | 6300 | 120 x 285 | 1/10 | 2 |
| 147-76025 | 5207227063824 | E | Magnolia | 60 | 2700 | 6300 | 120 x 285 | 1/10 | 2 |
| 147-76026 | 5207227063831 | E | Magnolia | 70 | 6500 | 7700 | 120 x 285 | 1/10 | 2 |
| 147-76027 | 5207227063848 | E | Magnolia | 70 | 4000 | 7700 | 120 x 285 | 1/10 | 2 |
| 147-76028 | 5207227063855 | E | Magnolia | 70 | 2700 | 7700 | 120 x 285 | 1/10 | 2 |
| 147-76030 | 5207227060892 | E | Magnolia | 80 | 6500 | 8800 | 120 x 285 | 1/10 | 2 |
| 147-76031 | 5207227063879 | E | Magnolia | 80 | 4000 | 8800 | 120 x 285 | 1/10 | 2 |
| 147-76032 | 5207227063893 | E | Magnolia | 80 | 2700 | 8800 | 120 x 285 | 1/10 | 2 |

Λαμπτήρες Φθορίου

Fluorescent
Lamp Tubes



TRI- Phosphor T8 - G13



Voltage 220-240V 50\60Hz • Lifetime 12.000h
 Cover Frost • Starting Time 3 sec • Operating Temperature -30° / +45°C
 Υλικό / Material Γυαλί & Μεταλλική Βάση / Glass & Metallic Base



| Code | Barcode | Type | Watt | Kelvin | Lumen | Dimension Ø (mm) † | Weight (kg) | Packing | MOQ |
|-----------|---------------|------|------|--------|-------|-----------------------|----------------|---------|-----|
| 147-88610 | 5206139011251 | T8 | 15 | 6500 | 610 | 26 x 450 | 0,08 | 1/25 | 25 |
| 147-88624 | 5206139011299 | T8 | 30 | 6500 | 2025 | 26 x 900 | 0,096 | 1/25 | 25 |
| 147-88625 | 5206139011381 | T8 | 18 | 6500 | 960 | 26 x 600 | 0,188 | 1/25 | 25 |
| 147-88626 | 5206139011398 | T8 | 36 | 6500 | 2650 | 26 x 1200 | 0,28 | 1/25 | 25 |
| 147-88627 | 5206139011435 | T8 | 58 | 6500 | 4270 | 26 x 1500 | 0,096 | 1/25 | 25 |
| 147-88640 | 5206139011404 | T8 | 18 | 4000 | 960 | 26 x 600 | 0,188 | 1/25 | 25 |

TRI- Phosphor T5 - G5



| Code | Barcode | Type | Watt | Kelvin | Lumen | Dimension Ø (mm) † | Weight (kg) | Packing | MOQ |
|-----------|---------------|------|------|--------|-------|-----------------------|----------------|----------|-----|
| 147-88607 | 5206139011954 | T5 | 8 | 6500 | 360 | 16 x 290 | 0,045 | 1/10/200 | 10 |
| 147-88609 | 5206139011961 | T5 | 13 | 6500 | 800 | 16 x 530 | 0,057 | 1/10/200 | 10 |



TRI- Phosphor T9 - G10Q Circular



Voltage 220-240V 50\60Hz • Lifetime 12.000h
 Cover Frost • Starting Time 3 sec • Operating Temperature -30° / +45°C
 Υλικό / Material Γυαλί & Πλαστική Βάση / Glass & Plastic Base



| Code | Barcode | Type | Watt | Kelvin | Lumen | Dimension Ø (mm) † | Weight (kg) | Packing | MOQ |
|-----------|---------------|------|-------|--------|-----------|-----------------------|----------------|---------|-----|
| 147-88635 | 5206139011442 | T9 | 22 | 6500 | 1500 | 30 x 209 | 0,18 | 1/20 | 5 |
| 147-88636 | 5206139011480 | T9 | 32 | 6500 | 2250 | 30 x 300 | 0,282 | 1/20 | 5 |
| 147-88637 | 5206139011497 | T9 | 40 | 6500 | 2800 | 30 x 400 | 0,422 | 1/20 | 5 |
| 147-88638 | 5206139011503 | T9 | 32/40 | 6500 | 2250/2800 | 30 x 300/400 | 0,642 | 1/20 | 5 |



T5 - G5 Blacklight

Voltage 220-240V 50\60Hz • Lifetime 12.000h
 Cover Frost • Starting Time 3 sec • Operating Temperature -30° / +45°C
 Υλικό / Material Μεταλλικό-Γυαλί / Metallic-Glass



| Code | Barcode | Type | Watt | Kelvin | Dimension Ø (mm) † | Weight (kg) | Packing | MOQ |
|-----------|---------------|------|------|-------------|-----------------------|----------------|----------|-----|
| 147-88601 | 5206139011244 | T5 | 6 | BLACK LIGHT | 16 x 212 | 0,03 | 1/10/200 | 5 |

Starters / S2 - S10

Voltage 220-240V 50\60Hz • Υλικό / Material Πλαστικό / Plastic



| Code | Barcode | Watt | Dimension Ø (mm) † | Weight (kg) | Packing | MOQ |
|-----------|---------------|------|-----------------------|----------------|---------|-----|
| 147-02202 | 5206139062444 | 4-22 | 20 x 40 | 0,006 | 25/500 | 25 |
| 147-02203 | 5206139062567 | 4-65 | 20 x 40 | 0,006 | 25/500 | 25 |



SOD-ED Pear shaped Νατρίου

Voltage 85-115V 50\60Hz • Lifetime 36.000h • On\Off 3.000
 Starting Time 0.30 sec • Operating Temperature -30° / +45°C
 Υλικό / Material Γυαλί & Βάση Αλουμινίου / Glass & Aluminium Base



| Code | Barcode | Energy Class | Base | Watt | Kelvin | Lumen | Dimension Ø (mm) † | Packing | MOQ |
|-----------|---------------|--------------|------|------|--------|-------|--------------------|---------|-----|
| 147-86011 | 5206139007940 | E | E27 | 70 | 2050 | 6230 | 54 x 145 | 1/40 | 1 |
| 147-86013 | 5206139007988 | E | E40 | 150 | 2050 | 17100 | 76 x 185 | 1/12 | 1 |
| 147-86015 | 5206139013323 | E | E40 | 250 | 2050 | 31000 | 90 x 228 | 1/12 | 1 |



SOD-T Tubular Νατρίου

Voltage 85-115V 50\60Hz • Lifetime 36.000h • On\Off 3.000
 Starting Time 0.30 sec • Operating Temperature -30° / +45°C
 Υλικό / Material Γυαλί & Βάση Αλουμινίου / Glass & Aluminium Base



| Code | Barcode | Energy Class | Watt | Kelvin | Lumen | Dimension Ø (mm) † | Packing | MOQ |
|-----------|---------------|--------------|------|--------|-------|--------------------|---------|-----|
| 147-86021 | 5206139013866 | E | 100 | 2050 | 11000 | 46 x 210 | 1/12 | 1 |
| 147-86022 | 5206139001832 | E | 150 | 2050 | 18000 | 46 x 210 | 1/12 | 1 |
| 147-86024 | 5206139001856 | E | 400 | 2050 | 57200 | 46 x 285 | 1/12 | 1 |

UV Stop Quartz Αλογόνου Μετάλλου



Προστασία Ακτινοβολίας UV
UV Radiation Protection



Voltage 80V 50\60Hz • Lifetime 20.000h • On\off 3.000
Starting Time 0.30 sec • Operating Temperature -30° / +45°C
Υλικό / Material Γυαλί & Μεταλλική Βάση / Glass & Metallic Base



| Code | Barcode | Energy Class | Watt | Kelvin | Lumen | Dimension Ø (mm) † | Packing | MOQ |
|-----------|---------------|--------------|------|--------|-------|-----------------------|---------|-----|
| 147-86121 | 5206139013903 | E | 250 | 4000 | 22000 | 46 x 242 | 1/12 | 1 |

UV Stop Quartz Pear shaped Αλογόνου Μετάλλου



Προστασία Ακτινοβολίας UV
UV Radiation Protection



Voltage 85-115V50\60Hz • Lifetime 20.000h • On\off 3.000
Starting Time 0.30 sec • Operating Temperature -30° / +45°C
Υλικό / Material Γυαλί & Βάση Αλουμινίου / Glass & Aluminium Base



| Code | Barcode | Energy Class | Watt | Kelvin | Lumen | Dimension Ø (mm) † | Packing | MOQ |
|-----------|---------------|--------------|------|--------|-------|-----------------------|---------|-----|
| 147-86131 | 5206139013941 | E | 100 | 4000 | 9600 | 55 x 145 | 1/40 | 1 |
| 147-86132 | 5206139013934 | E | 150 | 4000 | 14400 | 55 x 145 | 1/40 | 1 |



147-88061

147-88062

147-88063



E27 Base

BR38 / PAR38

Λαμπτήρες Χοιροστασίου Infrared Lamps

Voltage 220-240V 50\60Hz • Lifetime 5.000h • On/Off 25.000

Cover Κόκκινο / Red - Διάφανο / Clear • Operating Temperature 400°C

Υλικό / Material Γυαλί & Βάση Αλουμινίου / Glass & Aluminium Base



DIMMABLE



1 YEAR WARRANTY

| Code | Barcode | Type | Watt | Dimension Ø (mm) † | Packing | MOQ |
|-----------|---------------|-------|------|-----------------------|---------|-----|
| 147-88061 | 5206139001757 | BR38 | 250 | 125 x 183 | 1/24 | 6 |
| 147-88062 | 5206139005021 | PAR38 | 175 | 120 x 134 | 1/12 | 6 |
| 147-88063 | 5207227103131 | PAR38 | 175 | 120 x 134 | 1/12 | 6 |





E27 / A60



E27 Base

Voltage 12V 50\60Hz • Lifetime 1.000h • On\Off 25.000
 Cover Διάφανο / Clear • Operating Temperature -30° / +45°C
 Υλικό / Material Γυαλί & Βάση Αλουμινίου / Glass & Aluminium Base



| Code | Barcode | Energy Class | Type | Watt | Lumen | Dimension Ø (mm) † | Packing | MOQ |
|-----------|---------------|--------------|------|------|-------|--------------------|----------|-----|
| 147-88130 | 5206139000828 | G | A60 | 40 | 400 | 60 x 107 | 1/10/100 | 10 |
| 147-88131 | 5206139000835 | G | A60 | 60 | 660 | 60 x 107 | 1/10/100 | 10 |



Λαμπτήρας Ψυγείου Refrigerator Lamp



E14 Base

Voltage 220-240V 50\60Hz • Lifetime 1.000h • On\Off 25.000
 Cover Διάφανο / Clear • Operating Temperature -30° / +45°C
 Υλικό / Material Γυαλί & Βάση Αλουμινίου / Glass & Aluminium Base



| Code | Barcode | Energy Class | Type | Watt | Lumen | Dimension Ø (mm) † | Packing | MOQ |
|-----------|---------------|--------------|------|------|-------|--------------------|----------|-----|
| 800-88094 | 5206139000293 | G | T22 | 15 | 120 | 20 x 53 | 1/10/200 | 10 |



147-88095



147-88096

Λαμπτήρας Φούρνου Oven Lamp



E14 Base

Voltage 220-240V 50\60Hz • Lifetime 1.000h • On\Off 25.000
 Cover Διάφανο / Clear • Operating Temperature 300°C
 Υλικό / Material Γυαλί & Βάση Αλουμινίου / Glass & Aluminium Base



| Code | Barcode | Type | Watt | Lumen | Dimension Ø (mm) † | Packing | MOQ |
|-----------|---------------|------|------|-------|--------------------|----------|-----|
| 147-88095 | 5206139000095 | T22 | 15 | 120 | 22 x 53 | 1/25/500 | 25 |
| 147-88096 | 5206139040176 | G45 | 40 | 200 | 45 x 80 | 1/10/100 | 10 |

| Code | Barcode | Type | Watt | Lumen | Dimension Ø (mm) † | Packing | MOQ |
|-----------|---------------|------|------|-------|--------------------|----------|-----|
| 800-88095 | 5206139000521 | T22 | 15 | 120 | 22 x 53 | 1/10/200 | 10 |

Λαμπτήρες Νυκτός Night Lamps



E14 Base

Voltage 220-240V 50\60Hz • Lifetime 1.000h • On\Off 25.000 • Operating Temperature -30°C / +45°C
Υλικό / Material Γυαλί & Βάση Αλουμινίου / Glass & Aluminium Base



| Code | Barcode | Type | Watt | Lumen | Cover | Dimension Ø (mm) † | Packing | MOQ |
|-----------|---------------|------|------|-------|--------------------|-----------------------|----------|-----|
| 147-88180 | 5206139000590 | T23 | 5 | 25 | ΔΙΑΦΑΝΟ / CLEAR | 20 x 53 | 1/25/500 | 25 |
| 147-88181 | 5206139000712 | T23 | 5 | 25 | ΗΜΙΔΙΑΦΑΝΟ / FROST | 20 x 53 | 1/25/500 | 25 |
| 147-88182 | 5206139000064 | T23 | 5 | - | ΚΟΚΚΙΝΟ / RED | 20 x 53 | 1/25/500 | 25 |
| 147-88183 | 5206139000736 | T20 | 5 | - | ΚΙΤΡΙΝΟ / YELLOW | 20 x 53 | 1/25/500 | 25 |
| 147-88184 | 5206139000743 | T23 | 5 | - | ΠΡΑΣΙΝΟ / GREEN | 20 x 53 | 1/25/500 | 25 |
| 147-88185 | 5206139000750 | T23 | 5 | - | ΜΠΛΕ / BLUE | 20 x 53 | 1/25/500 | 25 |



| Code | Barcode | Type | Watt | Lumen | Cover | Dimension Ø (mm) † | Packing | MOQ |
|-----------|---------------|------|------|-------|--------------------|-----------------------|----------|-----|
| 800-88180 | 5206139000538 | T20 | 5 | 25 | ΔΙΑΦΑΝΟ / CLEAR | 20 x 53 | 1/10/200 | 10 |
| 800-88181 | 5206139000545 | T23 | 5 | 25 | ΗΜΙΔΙΑΦΑΝΟ / FROST | 20 x 53 | 1/10/200 | 10 |
| 800-88182 | 5206139000552 | T23 | 5 | - | ΚΟΚΚΙΝΟ / RED | 20 x 53 | 1/10/200 | 10 |
| 800-88183 | 5206139000569 | T20 | 5 | - | ΚΙΤΡΙΝΟ / YELLOW | 20 x 53 | 1/10/200 | 10 |
| 800-88184 | 5206139000576 | T23 | 5 | - | ΠΡΑΣΙΝΟ / GREEN | 20 x 53 | 1/10/200 | 10 |
| 800-88185 | 5206139000583 | T23 | 5 | - | ΜΠΛΕ / BLUE | 20 x 53 | 1/10/200 | 10 |

Λαμπτήρες Νυκτός Night Lamps



E27 Base

Voltage 220-240V 50\60Hz • Lifetime 1.000h • On\Off 25.000 • Operating Temperature -30°C / +45°C
Υλικό / Material Γυαλί & Βάση Αλουμινίου / Glass & Aluminium Base



DIMMABLE



1 YEAR WARRANTY

| Code | Barcode | Type | Watt | Lumen | Cover | Dimension Ø (mm) † | Packing | MOQ |
|-----------|---------------|------|------|-------|--------------------|-----------------------|----------|-----|
| 147-88170 | 5206139000224 | T30 | 5 | 25 | ΔΙΑΦΑΝΟ / CLEAR | 30 x 60 | 1/25/500 | 25 |
| 147-88171 | 5206139000231 | T30 | 5 | 25 | ΗΜΙΔΙΑΦΑΝΟ / FROST | 30 x 60 | 1/25/500 | 25 |
| 147-88172 | 5206139000248 | T30 | 5 | - | ΚΟΚΚΙΝΟ / RED | 30 x 60 | 1/25/500 | 25 |
| 147-88173 | 5206139000255 | T30 | 5 | - | ΚΙΤΡΙΝΟ / YELLOW | 30 x 60 | 1/25/500 | 25 |
| 147-88174 | 5206139000262 | T30 | 5 | - | ΠΡΑΣΙΝΟ / GREEN | 30 x 60 | 1/25/500 | 25 |
| 147-88175 | 5206139000279 | T30 | 5 | - | ΜΠΛΕ / BLUE | 30 x 60 | 1/25/500 | 25 |



E27 Base

| Code | Barcode | Type | Watt | Lumen | Cover | Dimension Ø (mm) † | Packing | MOQ |
|-----------|---------------|------|------|-------|--------------------|-----------------------|----------|-----|
| 800-88170 | 5206139000767 | T30 | 5 | 25 | ΔΙΑΦΑΝΟ / CLEAR | 30 x 60 | 1/10/200 | 10 |
| 800-88171 | 5206139000774 | T30 | 5 | 25 | ΗΜΙΔΙΑΦΑΝΟ / FROST | 30 x 60 | 1/10/200 | 10 |
| 800-88172 | 5206139000781 | T30 | 5 | - | ΚΟΚΚΙΝΟ / RED | 30 x 60 | 1/10/200 | 10 |
| 800-88173 | 5206139000798 | T30 | 5 | - | ΚΙΤΡΙΝΟ / YELLOW | 30 x 60 | 1/10/200 | 10 |
| 800-88174 | 5206139001764 | T30 | 5 | - | ΠΡΑΣΙΝΟ / GREEN | 30 x 60 | 1/10/200 | 10 |
| 800-88175 | 5206139001771 | T30 | 5 | - | ΜΠΛΕ / BLUE | 30 x 60 | 1/10/200 | 10 |



B22 Base

| Code | Barcode | Type | Watt | Lumen | Cover | Dimension Ø (mm) † | Packing | MOQ |
|-----------|---------------|------|------|-------|-----------------|-----------------------|----------|-----|
| 800-88160 | 5206139043429 | T30 | 5 | 25 | Διάφανο / Clear | 30 x 60 | 1/10/200 | 10 |

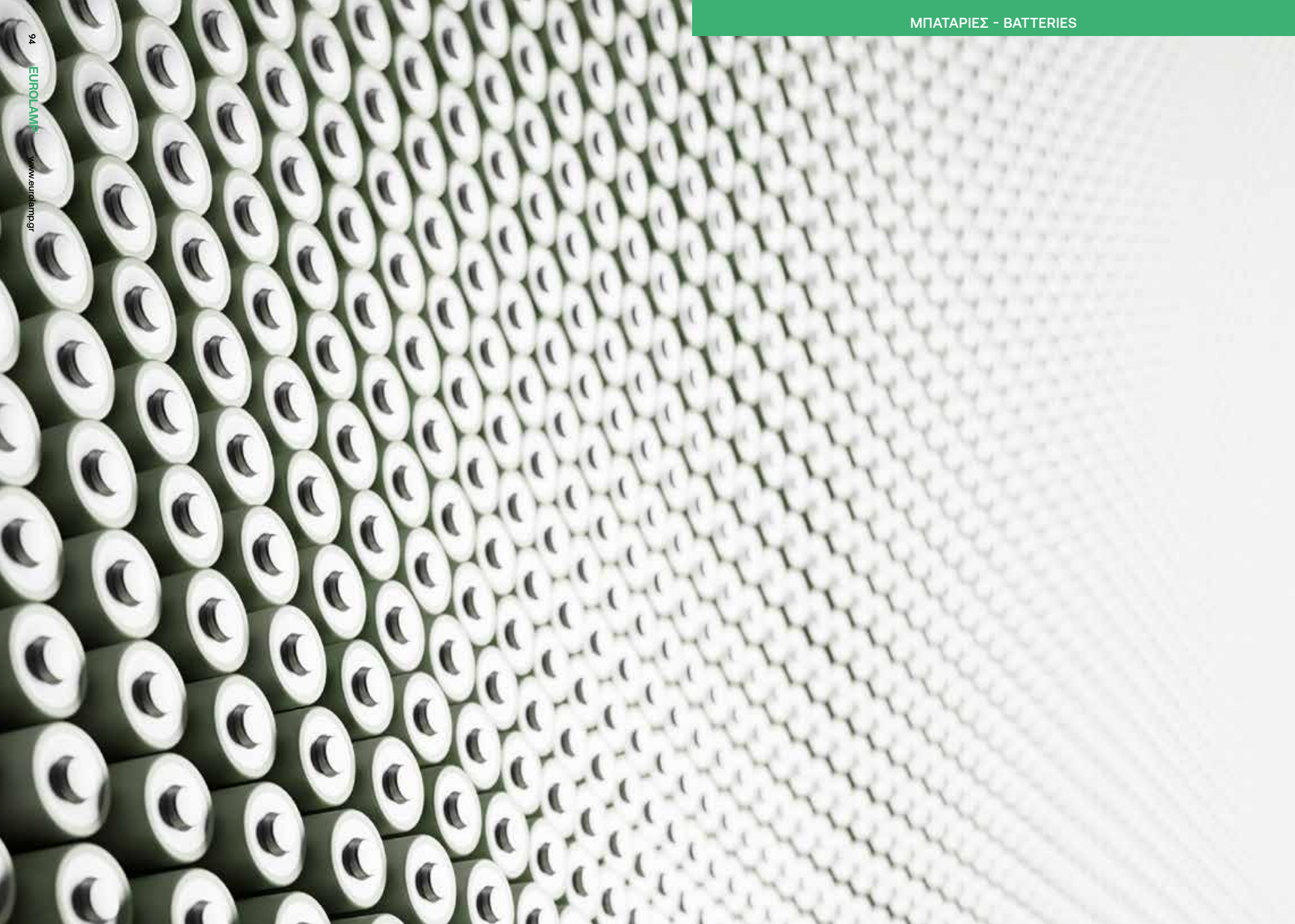



Μπαταρίες

Batteries



extreme
POWER **AAA LR03**



10 Years Shelf Life

Type AAA LR03 • Volt 1.5V • Operating Temperature -20°C / +50°C

Υλικό / Material Διοξείδιο Ψευδαργύρου-Μαγγανίου, Περιβλήμα: Αλουμίνιο / Zinc - Manganese Dioxide, Jacket: Aluminium

| Code | Barcode | Pieces Per Pack | Packing | MOQ |
|-----------|---------------|-----------------|----------|-----|
| 147-24120 | 5207227115349 | 4 | 1/12/120 | 12 |
| 147-24125 | 5207227115493 | 8 | 1/10/30 | 10 |
| 147-24127 | 5207227115554 | 24 | 1/5/60 | 5 |



147-24142



147-24144

extreme
POWER **AAA LR03 Paper Display**



10 Years Shelf Life

Type AAA LR03 • Volt 1.5V • Operating Temperature -20°C / +50°C

Υλικό / Material Διοξείδιο Ψευδαργύρου-Μαγγανίου, Περιβλήμα: Αλουμίνιο / Zinc - Manganese Dioxide, Jacket: Aluminium

| Code | Barcode | Packs Per Display | Pieces Per Pack | Packing | MOQ |
|-----------|---------------|-------------------|-----------------|---------|-----|
| 147-24142 | 5207227409424 | 70 | 8 | 1/70 | 70 |
| 147-24144 | 5207227409462 | 36 | 24 | 1/36 | 36 |



extreme
POWER AA LR6



10 Years Shelf Life

Type AA LR6 • Volt 1.5V • Operating Temperature -20°C / +50°C

Υλικό / Material Διοξειδίο Ψευδαργύρου-Μαγγανίου, Περιβλήμα: Αλουμίνιο / Zinc - Manganese Dioxide, Jacket: Aluminium

| Code | Barcode | Pieces Per Pack | Packing | MOQ |
|-----------|---------------|-----------------|----------|-----|
| 147-24121 | 5207227115370 | 4 | 1/12/120 | 12 |
| 147-24126 | 5207227115523 | 8 | 1/10/30 | 10 |
| 147-24128 | 5207227115585 | 24 | 1/5/30 | 5 |



147-24143



147-24145

extreme
POWER AA LR6 Paper Display



10 Years Shelf Life

Type AA LR6 • Volt 1.5V • Operating Temperature -20°C / +50°C

Υλικό / Material Διοξειδίο Ψευδαργύρου-Μαγγανίου, Περιβλήμα: Αλουμίνιο / Zinc - Manganese Dioxide, Jacket: Aluminium

| Code | Barcode | Packs Per Display | Pieces Per Pack | Packing | MOQ |
|-----------|---------------|-------------------|-----------------|---------|-----|
| 147-24143 | 5207227409301 | 40 | 8 | 1/40 | 40 |
| 147-24145 | 5207227409448 | 30 | 24 | 1/30 | 30 |

extreme
POWER C LR14



10 Years Shelf Life

Type C LR14 • Volt 1.5V • Operating Temperature -20°C / +50°C

Υλικό / Material Διοξειδίο Ψευδαργύρου-Μαγγανίου, Περιβλήμα: Αλουμίνιο / Zinc - Manganese Dioxide, Jacket: Aluminium

| Code | Barcode | Pieces Per Pack | Packing | MOQ |
|-----------|---------------|-----------------|---------|-----|
| 147-24122 | 5207227115400 | 2 | 1/12/72 | 12 |

extreme
POWER D LR20



10 Years Shelf Life

Type D LR20 • Volt 1.5V • Operating Temperature -20°C / +50°C

Υλικό / Material Διοξειδίο Ψευδαργύρου-Μαγγανίου, Περιβλήμα: Αλουμίνιο / Zinc - Manganese Dioxide, Jacket: Aluminium

| Code | Barcode | Pieces Per Pack | Packing | MOQ |
|-----------|---------------|-----------------|---------|-----|
| 147-24123 | 5207227115431 | 2 | 1/12/72 | 12 |

extreme
POWER 6LR61



10 Years Shelf Life

Type 6LR61 • Volt 9V • Operating Temperature -20°C / +50°C

Υλικό / Material Διοξειδίο Ψευδαργύρου-Μαγγανίου, Περιβλήμα: Αλουμίνιο / Zinc - Manganese Dioxide, Jacket: Aluminium

| Code | Barcode | Pieces Per Pack | Packing | MOQ |
|-----------|---------------|-----------------|----------|-----|
| 147-24124 | 5207227115462 | 1 | 1/12/240 | 12 |

extreme
POWER **27A**



10 Years Shelf Life

Type 27A • Volt 12V • Operating Temperature -20°C / +50°C

Υλικό / Material Διοξειδίο Ψευδαργύρου-Μαγγανίου, Περιβλήμα: Αλουμίνιο / Zinc - Manganese Dioxide, Jacket: Aluminium

| Code | Barcode | Pieces Per Pack | Packing | MOQ |
|-----------|---------------|-----------------|----------|-----|
| 147-24140 | 5207227267895 | 1 | 1/20/320 | 20 |

extreme
POWER **23A**



10 Years Shelf Life

Type 23A • Volt 12V • Operating Temperature -20°C / +50°C

Υλικό / Material Διοξειδίο Ψευδαργύρου-Μαγγανίου, Περιβλήμα: Αλουμίνιο / Zinc - Manganese Dioxide, Jacket: Aluminium

| Code | Barcode | Pieces Per Pack | Packing | MOQ |
|-----------|---------------|-----------------|----------|-----|
| 147-24141 | 5207227267925 | 1 | 1/20/320 | 20 |

extreme
POWER

CR2032 / CR2025
CR2016 / CR1616 / CR2430 / CR2450



10 Years Shelf Life

Type CR2032 / CR2025 / CR2016 / CR1616 / CR2430 / CR2450 • Volt 3V • Operating Temperature -20°C / +50°C

Υλικό / Material Διοξειδίο Λιθίου-Ψευδαργύρου-Μαγγανίου, Περιβλήμα: Σίδηρος / Lithium-Zinc-Manganese Dioxide/ Jacket: Iron

| Code | Barcode | Battery Type | Pieces Per Pack | Packing | MOQ |
|-----------|---------------|--------------|-----------------|----------|-----|
| 147-24130 | 5207227267628 | CR2032 | 1 | 1/20/320 | 20 |
| 147-24131 | 5207227267659 | CR2025 | 1 | 1/20/320 | 20 |
| 147-24132 | 5207227267680 | CR2016 | 1 | 1/20/320 | 20 |
| 147-24133 | 5207227267710 | CR1616 | 1 | 1/20/320 | 20 |
| 147-24134 | 5207227267741 | CR2430 | 1 | 1/20/320 | 20 |
| 147-24135 | 5207227267772 | CR2450 | 1 | 1/20/320 | 20 |



super
POWER **AAA LR03**



10 Years Shelf Life

Type AAA LR03 • Volt 1.5V • Operating Temperature -20°C / +50°C

Υλικό / Material Διοξειδίο Ψευδαργύρου-Μαγγανίου, Περιβλήμα: Αλουμίνιο / Zinc - Manganese Dioxide, Jacket: Aluminium

| Code | Barcode | Pieces Per Pack | Packing | MOQ |
|-----------|---------------|-----------------|----------|-----|
| 147-24100 | 5206139090003 | 4 | 1/12/120 | 12 |
| 147-24150 | 5207227064470 | 8 | 1/10/30 | 10 |
| 147-24162 | 5207227020124 | 24 | 1/5/160 | 5 |



super
POWER **AA LR6**



10 Years Shelf Life

Type AAA LR03 • Volt 1.5V • Operating Temperature -20°C / +50°C

Υλικό / Material Διοξειδίο Ψευδαργύρου-Μαγγανίου, Περιβλήμα: Αλουμίνιο / Zinc - Manganese Dioxide, Jacket: Aluminium

| Code | Barcode | Pieces Per Pack | Packing | MOQ |
|-----------|---------------|-----------------|----------|-----|
| 147-24101 | 5206139090010 | 4 | 1/12/120 | 12 |
| 147-24151 | 5207227064500 | 8 | 1/10/30 | 10 |
| 147-24163 | 5207227020155 | 24 | 1/5/30 | 5 |

super
POWER 23A



Type 23A • Volt 12V • Operating Temperature -20°C / +50°C

Υλικό / Material Διοξειδίο Ψευδαργύρου-Μαγγανίου, Περιβλήμα: Αλουμίνιο / Zinc - Manganese Dioxide, Jacket: Aluminium

| Code | Barcode | Pieces Per Pack | Packing | MOQ |
|-----------|---------------|-----------------|----------|-----|
| 147-24105 | 5206139090058 | 5 | 1/20/200 | 5 |

super
POWER AG13

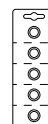

Type AG13 • Volt 1.5V • Operating Temperature -20°C / +50°C

Υλικό / Material Διοξειδίο Ψευδαργύρου-Μαγγανίου, Περιβλήμα: Σίδηρος / Zinc-Manganese Dioxide, Jacket: Iron

| Code | Barcode | Pieces Per Pack | Packing | MOQ |
|-----------|---------------|-----------------|----------|-----|
| 147-24112 | 5206139096609 | 5 | 1/12/120 | 6 |

LITHIUM CR2032 / CR2025

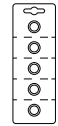

Type CR2032 / CR2025 • Volt 3V • Operating Temperature -30°C / +70°C

Υλικό / Material Διοξειδίο Λιθίου-Ψευδαργύρου-Μαγγανίου, Περιβλήμα: Σίδηρος / Lithium-Zinc-Manganese Dioxide/ Jacket: Iron

| Code | Barcode | Battery Type | Pieces Per Pack | Packing | MOQ |
|-----------|---------------|--------------|-----------------|----------|-----|
| 147-24110 | 5206139096586 | CR2032 | 5 | 1/12/120 | 6 |
| 147-24111 | 5206139096593 | CR2025 | 5 | 1/12/120 | 6 |

ΜΠΑΤΑΡΙΕΣ ΕΠΑΝΑΦΟΡΤΙΖΟΜΕΝΕΣ NI-MH - RECHARGEABLE NI-MH BATTERIES

NI-MH Rechargeable AAA HR03 / AA HR6



Type CR2032 / CR2025 • Volt 1.2V • Operating Temperature -20°C / +50°C

Υλικό / Material Ni-MH

| Code | Barcode | Battery Type | Battery Capacity | Pieces Per Pack | Packing | MOQ |
|-----------|---------------|--------------|------------------|-----------------|----------|-----|
| 147-24200 | 5207227001765 | HR03 | 1000mAh | 2 | 1/12/120 | 12 |
| 147-24210 | 5207227001772 | HR6 | 2400mAh | 2 | 1/12/120 | 12 |



Φακοί

Flashlights



• Μεταβαλλόμενη δέσμη / Zoom function: 30m-100m

LED Φακός Μπαταρίας Αλουμινίου με λειτουργία Zoom
LED Battery Flashlight with Zoom Function

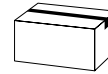

Voltage 4,5V DC • LED Type CREE COB
 Χρόνος Αποφόρτισης Μπαταρίας / Battery Discharge Time 7h
 Υλικό / Material Αλουμίνιο / Aluminium

| | | |
|------------------------------|-------------------------------|----------------------------|
| BEAM DISTANCE 100m | BEAM ANGLE 10°-120° | 2 YEARS WARRANTY |
|------------------------------|-------------------------------|----------------------------|

| Code | Barcode | Color | Watt | Lumen | Dimension Ø (mm) ↔ | Weight (kg) | Packing | MOQ |
|-----------|---------------|-------|------|-------|--------------------|-------------|---------|-----|
| 145-24507 | 5206139080400 | Black | 3 | 150 | 34,6 x 112 | 0,087 | 1\16\64 | 16 |

Zoom out ————— 5m ————— Zoom in

Εμβέλεια: 100m
 Λειτουργίες: Υψηλή-Χαμηλή-Flashing-Zoom
 Range: 100m
 Functions: High-Low-Flashing-Zoom



Λειτουργίες / Functions:

- 100%-50% - Κόκκινο φως - Κόκκινο φλας / 100%-50% - Red light - Red light flashing
- Εύκολη αφαίρεση / Easily removable
- Περιλαμβάνει μαγνήτες / Includes magnets
- Πολλαπλές γωνίες κλίσης / Selectable viewing angles

LED Φακός Κεφαλής Μπαταρίας Εργασίας
LED Battery Work Head Light

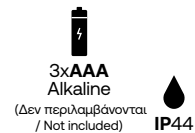

Voltage 3xAAA Alkaline batteries • LED Type COB • Operating Temperature -30° / +45°C
 Χρόνος Αποφόρτισης Μπαταρίας / Battery Discharge Time 2,5h
 Υλικό / Material Πλαστικό ABS + TPR / Plastic ABS + TPR

| | |
|------------------------------|----------------------------|
| BEAM DISTANCE 100m | 2 YEARS WARRANTY |
|------------------------------|----------------------------|

| Code | Barcode | Color | Watt | Lumen | Dimension (mm) ↕ ↔ ↕ | Weight (kg) | Packing | MOQ |
|-----------|---------------|----------------|------|-------|----------------------|-------------|---------|-----|
| 145-24515 | 5207227243134 | Black + Orange | 5 | 300 | 40 x 69 x 40 | 0,087 | 1\8\32 | 8 |



LED Φακός Μπαταρίας Αλουμινίου Αδιάβροχος LED Battery Flashlight Waterproof



Voltage 3V DC • LED Type XPE • Operating Temperature -20°C / +45°C
Χρόνος Αποφόρτισης Μπαταρίας / Battery Discharge Time 24h
Υλικό / Material Aluminum + PP + Rubber



| Code | Barcode | Color | Watt | Kelvin | Lumen | Dimension Ø (mm) ↔ | Weight (kg) | Packing | MOQ |
|-----------|---------------|-------|------|-----------|-------|-----------------------|----------------|---------|-----|
| 145-24520 | 5207227116759 | Blue | 1 | 5000-6500 | 150 | 45 x 163 | 0,118 | 1\12\24 | 3 |
| 145-24521 | 5207227116766 | Red | 1 | 5000-6500 | 150 | 45 x 163 | 0,118 | 1\12\24 | 3 |



- Μεταβαλλόμενη δέσμη / Zoom function: 30m-100m
- Λουράκι καρπού / Wrist Cord

LED Φακός Μπαταρίας Αδιάβροχος "Τσέπης" LED Battery Flashlight Waterproof "Pocket"

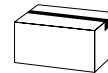

Voltage 3V DC • LED Type CREE XTE
Χρόνος Αποφόρτισης Μπαταρίας / Battery Discharge Time 1h
Υλικό / Material Aluminum



| Code | Barcode | Color | Watt | Kelvin | Lumen | Dimension Ø (mm) ↔ | Weight (kg) | Packing | MOQ |
|-----------|---------------|-------|------|--------|-------|-----------------------|----------------|---------|-----|
| 145-24523 | 5207227116780 | Black | 5 | 5000 | 200 | 16,5 x 123 | 0,027 | 1\24\96 | 24 |



- Power Bank & USB Cable type A to C
- Λειτουργίες / Functions: 35%-70%-100%-Strobe-SOS
- Μεταβαλλόμενη δέσμη / Zoom function: 100m-700m

LED Φακός Επαναφορτιζόμενος με Power Bank LED Flashlight Rechargeable with Power Bank



Voltage 5V DC • LED Type White Laser 5050 • Operating Temperature -20°C / +45°C
Χρόνος Αποφόρτισης Μπαταρίας / Battery Discharge Time 6h (100%) up to 45h (30%)
Χωρητικότητα Μπαταρίας / Battery Capacity 4500mAh • Υλικό / Material Aluminum



| Code | Barcode | Color | Watt | Kelvin | Lumen | Dimension Ø (mm) ↔ | Weight (kg) | Packing | MOQ |
|-----------|---------------|-------|------|-----------|-------|-----------------------|----------------|---------|-----|
| 145-24531 | 5206139080400 | Black | 10 | 6500-7500 | 1100 | 43 x 123 | 0,267 | 1\6\24 | 1 |



Μίνι Φακός Επαναφορτιζόμενος Mini Flashlight Rechargeable

Voltage 5V DC • LED Type COB • Operating Temperature -20°C / +45°C
Χρόνος Αποφόρτισης Μπαταρίας / Battery Discharge Time 2h (100%) up to 15h (30%)
Χωρητικότητα Μπαταρίας / Battery Capacity 600mAh • Υλικό / Material Aluminum

- Magnet & USB cable type A to C
- Λειτουργίες / Functions: 100%-50%-30%-OFF
- Παρατεταμένο πάτημα για 3δευτ. λειτουργία turbo
Pressing the switch for 3sec for turbo mode

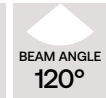

| Code | Barcode | Color | Watt | Kelvin | Lumen | Dimension Ø (mm) ↔ | Weight (kg) | Packing | MOQ |
|-----------|---------------|-------|------|--------|-------|--------------------|-------------|---------|-----|
| 145-24532 | 5207227295621 | Black | 10 | 6500 | 1000 | 22,5 x 73 | 0,047 | 1\8\32 | 8 |



Φακός Κεφαλής Επαναφορτιζόμενος με Αισθητήρα Κίνησης Head Light Rechargeable with Motion Sensor

Voltage 5V DC • LED Type CREE XTE + 2xRED LED • Operating Temperature -20°C / +45°C
Χρόνος Αποφόρτισης Μπαταρίας / Battery Discharge Time 1-5h
Χωρητικότητα Μπαταρίας / Battery Capacity 650mAh • Υλικό / Material Plastic ABS + TPR

- Λειτουργίες / Functions:
Low-Mid-High-Super-Red-Red flashing
- Περιλαμβάνει καλώδιο USB
- 2ος διακόπτης για αισθητήρα κίνησης
2nd switch for sensor mode

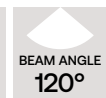

| Code | Barcode | Color | Watt | Kelvin | Lumen | Dimension (mm) ↕ ↔ ↕ | Weight (kg) | Packing | MOQ |
|-----------|---------------|-------|------|--------|-------|----------------------|-------------|---------|-----|
| 145-24533 | 5207227243103 | Black | 3 | 6500 | 220 | 40 x 69 x 40 | 0,037 | 1\8\32 | 8 |



Φακός Καπέλου Επαναφορτιζόμενος με Αισθητήρα Κίνησης Hat Flashlight Rechargeable with Motion Sensor

Voltage 5V DC • LED Type XPE + 6W COB • Operating Temperature -30°C / +45°C
Χρόνος Αποφόρτισης Μπαταρίας / Battery Discharge Time 1-3h
Χωρητικότητα Μπαταρίας / Battery Capacity 500mAh • Υλικό / Material Aluminum + Plastic

- Λειτουργίες / Functions:
LED κεφαλής / COB 100%-50%-30%-RED-Flash-OFF
- Παρατεταμένο πάτημα λειτουργία αισθητήρα /
Press switch for 2sec sensor mode
- Περιλαμβάνει μαγνήτη, ανοιχτήρι μπουκαλιών και καλώδιο USB /
Includes magnet, bottle opener, USB cable

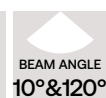

| Code | Barcode | Color | Watt | Kelvin | Lumen | Dimension (mm) ↕ ↔ ↕ | Weight (kg) | Packing | MOQ |
|-----------|---------------|------------|------|--------|-------|----------------------|-------------|---------|-----|
| 145-24536 | 5207227243134 | Army Green | 5 | 6500 | 500 | 26 x 50 x 62 | 0,04 | 1\8\32 | 8 |



- Λειτουργίες / Functions:
High-Low-SMD-Red-Red flashing-Off
- Περιλαμβάνει καλώδιο USB
- Ρύθμιση της έντασης με το πάτημα ενός κουμπιού/
Dimming filament by pressing switch

LED Φανάρι με Φακό για Camping Battery Camping Led Light



Voltage 5V DC • LED Type CREE XTE + Filament • Operating Temperature -20°C / +45°C
Χρόνος Αποφόρτισης Μπαταρίας / Battery Discharge Time 3-8h
Χωρητικότητα Μπαταρίας / Battery Capacity 2000mAh • Υλικό / Material Plastic ABS + TPR

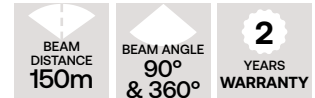

| Code | Barcode | Color | Watt | Kelvin | Lumen | Dimension (mm) | | | Weight (kg) | Packing | MOQ |
|-----------|---------------|-------|------|-------------|-----------|----------------|------|----|-------------|---------|-----|
| | | | | | | ↗ | ↔ | ↘ | | | |
| 145-24539 | 5207227295638 | Grey | 3 | 6500 & 2700 | 300 + 100 | 155 x | 70 x | 70 | 0,17 | 1\6\24 | 1 |







Φωτιστικά LED
Πάνελ

LED Lighting
Panels



3CCT
3000K 4000K 6500K

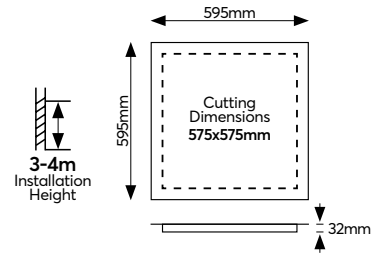

○ Λευκό / White



60X60 UGR19



LED Type SMD2835 • Chip Brand Sanan • Volt 220-240V 50/60Hz • Output Volt 36V DC
Start Time 0,5sec • PF > 0,90 • Operating Temperature -20°C / +40°C
Connection Καλώδιο / Wire
Production Material Αλουμίνιο & Πλαστικό / Aluminium & Plastic

| | | | | |
|-----------------------------|------------------|-------------------|--------------|------------------|
| LUMEN / WATT lm/W 135 | CRI Ra >80 | BEAM ANGLE 90° | NON DIMMABLE | 5 YEARS WARRANTY |
|-----------------------------|------------------|-------------------|--------------|------------------|

| Code | Barcode | Watt | Amperage mA | Kelvin | Total Lumen | Weight (kg) | Packing | MOQ |
|-----------|---------------|------|-------------|--------|-------------|-------------|---------|-----|
| 145-56350 | 5207227282942 | 36 | 900 | 3CCT | 4860 | 1,480 | 1\5 | 1 |

ΣΥΜΒΑΤΟ DRIVER / COMPATIBLE DRIVER: DIMMABLE 145-56187 / DALI 145-56188



○ Λευκό / White



3CCT
3000K 4000K 6500K

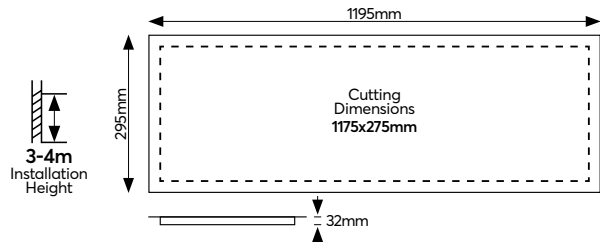

120X30 UGR19



LED Type SMD2835 • Chip Brand Sanan • Volt 220-240V 50/60Hz • Output Volt 36V DC
Start Time 0,5sec • PF > 0,90 • Operating Temperature -20°C / +40°C
Connection Καλώδιο / Wire
Production Material Αλουμίνιο & Πλαστικό / Aluminium & Plastic

| | | | | |
|-----------------------------|------------------|-------------------|--------------|------------------|
| LUMEN / WATT lm/W 135 | CRI Ra >80 | BEAM ANGLE 90° | NON DIMMABLE | 5 YEARS WARRANTY |
|-----------------------------|------------------|-------------------|--------------|------------------|

| Code | Barcode | Watt | Amperage mA | Kelvin | Total Lumen | Weight (kg) | Packing | MOQ |
|-----------|---------------|------|-------------|--------|-------------|-------------|---------|-----|
| 145-56351 | 5207227282966 | 36 | 900 | 3CCT | 4860 | 1,580 | 1\5 | 1 |

ΣΥΜΒΑΤΟ DRIVER / COMPATIBLE DRIVER: DIMMABLE 145-56187 / DALI 145-56188

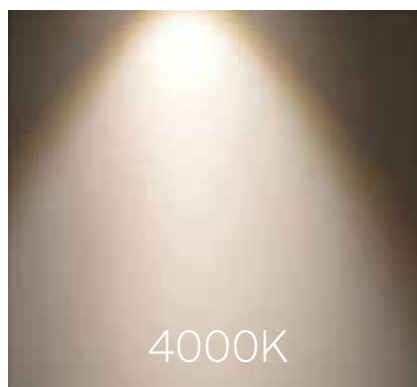
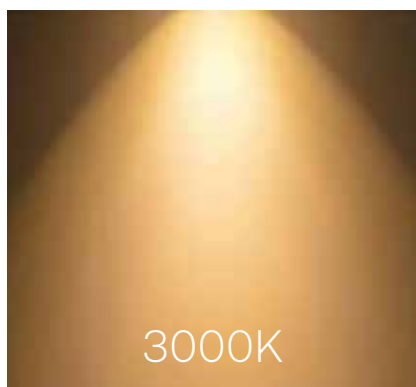

LED Χωνευτό Backlight Panel 3CCT

Το LED Χωνευτό Backlight Panel 3CCT είναι μια ευέλικτη λύση φωτισμού σχεδιασμένη για σύγχρονους εσωτερικούς χώρους. Προσφέρει τρεις επιλογές θερμοκρασίας χρώματος (3000K, 4000K και 6500K) για να ταιριάζει σε διαφορετικές διαθέσεις και περιβάλλοντα. Με τον κομψό σχεδιασμό και την ενεργειακά αποδοτική τεχνολογία του, αυτό το πάνελ παρέχει ομοιόμορφο φωτισμό και ενισχύει την αισθητική κάθε χώρου. Επιπλέον, διαθέτει εντυπωσιακή απόδοση 135 lumens ανά watt (lm/W) και συνοδεύεται από 5 χρόνια εγγύηση για απόλυτη εμπιστοσύνη.

LED Recessed Backlight Panel 3CCT

The LED Recessed Backlight Panel 3CCT is a versatile lighting solution designed for modern interiors. It offers three color temperature options (3000K, 4000K, and 6500K) to suit different moods and settings. With its sleek design and energy-efficient technology, this panel provides uniform illumination and enhances the aesthetic appeal of any space. Additionally, it boasts an impressive 135 lumens per watt (lm/W) efficiency and comes with a 5-year warranty for peace of mind.



○ Λευκό / White

60X60 • 120X30 UGR19



LED Type SMD2835 • Chip Brand Sanan • Volt 220-240V 50/60Hz • Output Volt 36V DC
 Start Time 0,5sec • PF > 0,90 • Operating Temperature -20°C / +40°C
 Installation Height 2-3m • Connection Καλώδιο / Wire
 Production Material Αλουμίνιο & Πλαστικό / Aluminium & Plastic

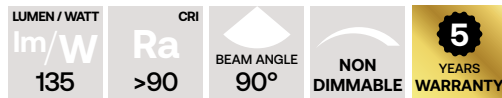

| Code | Barcode | Dimension (mm) ↕ ↔ ↕ | Watt | Amperage mA | Kelvin | Total Lumen | Weight (kg) | Packing | MOQ |
|-----------|---------------|-------------------------|------|----------------|--------|-------------|----------------|---------|-----|
| 145-56320 | 5207227327872 | 595 x 595 x 28 | 32 | 140 | 6500 | 4320 | 1.830 | 1\6 | 1 |
| 145-56321 | 5207227327896 | 595 x 595 x 28 | 32 | 140 | 4000 | 4320 | 1.830 | 1\6 | 1 |
| 145-56322 | 5207227327919 | 595 x 595 x 28 | 32 | 140 | 3000 | 4320 | 1.830 | 1\6 | 1 |
| 145-56323 | 5207227327933 | 295 x 1195 x 28 | 32 | 140 | 6500 | 4320 | 2.030 | 1\6 | 1 |
| 145-56324 | 5207227327957 | 295 x 1195 x 28 | 32 | 140 | 4000 | 4320 | 2.030 | 1\6 | 1 |
| 145-56325 | 5207227327971 | 295 x 1195 x 28 | 32 | 140 | 3000 | 4320 | 2.030 | 1\6 | 1 |

SYMBATO DRIVER / COMPATIBLE DRIVER: DIMMABLE 145-56187 / DALI 145-56188



60X60 • 120X30 UGR19



LED Type SMD2835 • Chip Brand Sanan • Volt 220-240V 50/60Hz • Output Volt 36V DC
 Start Time 0,5sec • PF > 0,90 • Operating Temperature -20°C / +40°C
 Installation Height 3-4m • Connection Καλώδιο / Wire
 Production Material Αλουμίνιο & Πλαστικό / Aluminium & Plastic

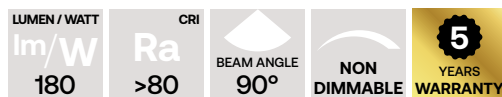

| Code | Barcode | Dimension (mm) ↕ ↔ ↕ | Watt | Amperage mA | Kelvin | Total Lumen | Weight (kg) | Packing | MOQ |
|-----------|---------------|-------------------------|------|----------------|--------|-------------|----------------|---------|-----|
| 145-56310 | 5207227282980 | 595 x 595 x 32 | 28 | 110 | 6500 | 5040 | 1.260 | 1\5 | 1 |
| 145-56311 | 5207227283000 | 595 x 595 x 32 | 28 | 110 | 4000 | 5040 | 1.260 | 1\5 | 1 |
| 145-56312 | 5207227283024 | 595 x 595 x 32 | 28 | 110 | 3000 | 5040 | 1.260 | 1\5 | 1 |
| 145-56313 | 5207227283048 | 295 x 1195 x 32 | 28 | 110 | 6500 | 5040 | 1.360 | 1\5 | 1 |
| 145-56314 | 5207227283062 | 295 x 1195 x 32 | 28 | 110 | 4000 | 5040 | 1.360 | 1\5 | 1 |
| 145-56315 | 5207227283086 | 295 x 1195 x 32 | 28 | 110 | 3000 | 5040 | 1.360 | 1\5 | 1 |

SYMBATO DRIVER / COMPATIBLE DRIVER: DIMMABLE 145-56187 / DALI 145-56188



○ Λευκό / White



60X60 • 120X30 UGR19

LED Type SMD2835 • Chip Brand Sanan • Volt 220-240V 50/60Hz • Output Volt 36V DC
 Start Time 0,5sec • PF > 0,90 • Operating Temperature -20°C / +40°C
 Installation Height 2-3m • Connection Καλώδιο / Wire
 Production Material Αλουμίνιο & Πλαστικό / Aluminium & Plastic

| | | | | |
|------------------------------|-------------------------|--------------------------|--------------|----------------------------|
| AMPERAGE mA 160 | CRI Ra >80 | BEAM ANGLE 90° | NON DIMMABLE | 5 YEARS WARRANTY |
|------------------------------|-------------------------|--------------------------|--------------|----------------------------|

| Code | Barcode | Dimension (mm) | | | Watt | Kelvin | Lumen/Watt | Total Lumen | Weight (kg) | Packing | MOQ |
|-----------|---------------|----------------|--------|----|------|--------|------------|-------------|-------------|---------|-----|
| | | ↗ | ↔ | ↘ | | | | | | | |
| 145-56330 | 5207227327995 | 595 x | 595 x | 32 | 36 | 6500 | 120 | 4320 | 1.800 | 1\6 | 1 |
| 145-56331 | 5207227328015 | 595 x | 595 x | 32 | 36 | 4000 | 120 | 4320 | 1.800 | 1\6 | 1 |
| 145-56332 | 5207227328039 | 595 x | 595 x | 32 | 36 | 3000 | 110 | 3960 | 1.800 | 1\6 | 1 |
| 145-56333 | 5207227328053 | 295 x | 1195 x | 32 | 36 | 6500 | 120 | 4320 | 2.000 | 1\6 | 1 |
| 145-56334 | 5207227328077 | 295 x | 1195 x | 32 | 36 | 4000 | 120 | 4320 | 2.000 | 1\6 | 1 |
| 145-56335 | 5207227328091 | 295 x | 1195 x | 32 | 36 | 3000 | 110 | 3960 | 2.000 | 1\6 | 1 |

SYMBATO DRIVER / COMPATIBLE DRIVER: DIMMABLE 145-56187 / DALI 145-56188



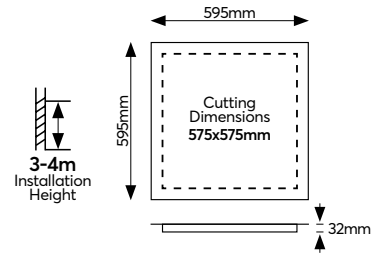

○ Λευκό / White

60X60 UGR19



LED Type SMD2835 · Chip Brand Samsung · Volt 220-240V 50/60Hz · Output Volt 130V DC
 Start Time 0,5sec · PF > 0,90 · Operating Temperature -20°C / +40°C
 Installation Height 3-4m · Connection Καλώδιο / Wire
 Production Material Αλουμίνιο & Πλαστικό / Aluminium & Plastic

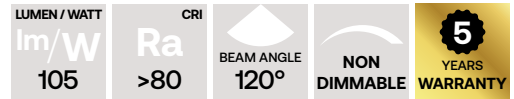

| Code | Barcode | Dimension (mm) | | | Watt | Amperage mA | Kelvin | Total Lumen | Weight (kg) | Packing | MOQ |
|-----------|---------------|----------------|-----|----|-------------|-------------|--------|-------------|-------------|---------|-----|
| | | ↗ | ↔ | ↕ | | | | | | | |
| 145-56230 | 5207227256820 | 595 | 595 | 32 | 27-34-40-48 | 350 | 6500 | 5040 | 1.305 | 1\10 | 1 |
| 145-56231 | 5207227243400 | 595 | 595 | 32 | 27-34-40-48 | 350 | 4000 | 5040 | 1.305 | 1\10 | 1 |
| 145-56232 | 5207227243424 | 595 | 595 | 32 | 27-34-40-48 | 350 | 3000 | 5040 | 1.305 | 1\10 | 1 |

ΣΥΜΒΑΤΟ DRIVER / COMPATIBLE DRIVER: DALI 145-56291 ANΤΑΛΛΑΚΤΙΚΟ DRIVER / SPARE DRIVER: 145-56290

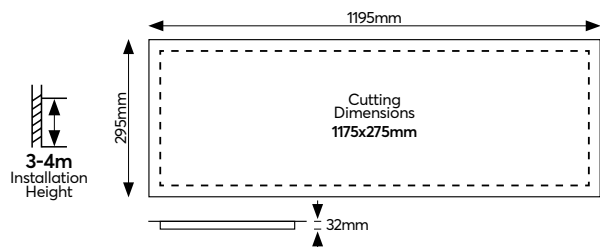

○ Λευκό / White

120X30 UGR19



LED Type SMD2835 · Chip Brand Samsung · Volt 220-240V 50/60Hz · Output Volt 130V DC
 Start Time 0,5sec · PF > 0,90 · Operating Temperature -20°C / +40°C
 Installation Height 3-4m · Connection Καλώδιο / Wire
 Production Material Αλουμίνιο & Πλαστικό / Aluminium & Plastic

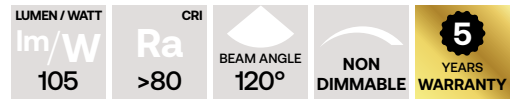

| Code | Barcode | Dimension (mm) | | | Watt | Amperage mA | Kelvin | Total Lumen | Weight (kg) | Packing | MOQ |
|-----------|---------------|----------------|-----|----|-------------|-------------|--------|-------------|-------------|---------|-----|
| | | ↗ | ↔ | ↕ | | | | | | | |
| 145-56233 | 5207227256837 | 1195 | 295 | 32 | 27-34-40-45 | 360 | 6500 | 4725 | 1.731 | 1\5 | 1 |
| 145-56234 | 5207227246333 | 1195 | 295 | 32 | 27-34-40-45 | 360 | 4000 | 4725 | 1.731 | 1\5 | 1 |
| 145-56235 | 5207227246357 | 1195 | 295 | 32 | 27-34-40-45 | 360 | 3000 | 4725 | 1.731 | 1\5 | 1 |

ΣΥΜΒΑΤΟ DRIVER / COMPATIBLE DRIVER: DALI 145-56291 ANΤΑΛΛΑΚΤΙΚΟ DRIVER / SPARE DRIVER: 145-56290

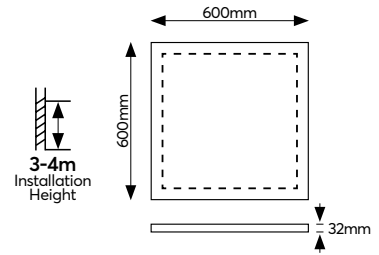

○ Λευκό / White

60X60 UGR19



LED Type SMD2835 · Chip Brand Samsung · Volt 220-240V 50/60Hz · Output Volt 130V DC
 Start Time 0,5sec · PF > 0,90 · Operating Temperature -20°C / +40°C
 Installation Height 3-4m · Connection Καλώδιο / Wire
 Production Material Αλουμίνιο & Πλαστικό / Aluminium & Plastic

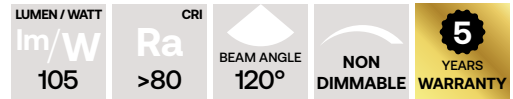

| Code | Barcode | Dimension (mm) | | | Watt | Amperage mA | Kelvin | Total Lumen | Weight (kg) | Packing | MOQ |
|-----------|---------------|----------------|-----|----|-------------|-------------|--------|-------------|-------------|---------|-----|
| | | ↗ | ↔ | ↕ | | | | | | | |
| 145-56240 | 5207227256844 | 600 | 600 | 46 | 27-34-40-48 | 350 | 6500 | 5040 | 1.871 | 1\7 | 1 |
| 145-56241 | 5207227256851 | 600 | 600 | 46 | 27-34-40-48 | 350 | 4000 | 5040 | 1.871 | 1\7 | 1 |
| 145-56242 | 5207227256875 | 600 | 600 | 46 | 27-34-40-48 | 360 | 3000 | 5040 | 1.871 | 1\7 | 1 |

ΣΥΜΒΑΤΟ DRIVER / COMPATIBLE DRIVER: DALI 145-56291 ANΤΑΛΛΑΚΤΙΚΟ DRIVER / SPARE DRIVER: 145-56290

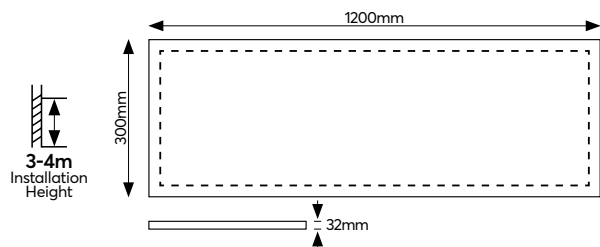

○ Λευκό / White

120X30 UGR19



LED Type SMD2835 · Chip Brand Samsung · Volt 220-240V 50/60Hz · Output Volt 130V DC
 Start Time 0,5sec · PF > 0,90 · Operating Temperature -20°C / +40°C
 Installation Height 3-4m · Connection Καλώδιο / Wire
 Production Material Αλουμίνιο & Πλαστικό / Aluminium & Plastic

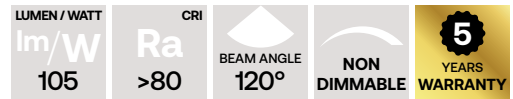

| Code | Barcode | Dimension (mm) | | | Watt | Amperage mA | Kelvin | Total Lumen | Weight (kg) | Packing | MOQ |
|-----------|---------------|----------------|-----|----|-------------|-------------|--------|-------------|-------------|---------|-----|
| | | ↗ | ↔ | ↕ | | | | | | | |
| 145-56250 | 5207227256905 | 1200 | 300 | 46 | 27-34-40-45 | 350 | 6500 | 4725 | 1.871 | 1\5 | 1 |
| 145-56251 | 5207227256912 | 1200 | 300 | 46 | 27-34-40-45 | 350 | 4000 | 4725 | 1.871 | 1\5 | 1 |
| 145-56252 | 5207227256929 | 1200 | 300 | 46 | 27-34-40-45 | 350 | 3000 | 4725 | 1.871 | 1\5 | 1 |

ΣΥΜΒΑΤΟ DRIVER / COMPATIBLE DRIVER: DALI 145-56291 ANΤΑΛΛΑΚΤΙΚΟ DRIVER / SPARE DRIVER: 145-56290

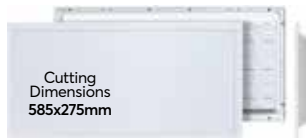

Λευκό / White

30X60 UGR19



LED Type SMD2835 • Chip Brand Samsung • Volt 220-240V 50/60Hz • Output Volt 110V DC
 Start Time 0,5sec • PF > 0,90 • Operating Temperature -20°C / +40°C
 Installation Height 3-4m • Connection Καλώδιο / Wire
 Production Material Αλουμίνιο & Πλαστικό / Aluminium & Plastic

| | | | | |
|-----------------------------|------------------|--------------------|--------------|------------------|
| LUMEN / WATT lm/W 105 | CRI Ra >80 | BEAM ANGLE 120° | NON DIMMABLE | 3 YEARS WARRANTY |
|-----------------------------|------------------|--------------------|--------------|------------------|

| Code | Barcode | Dimension (mm) ↕ ↔ ↘ | Watt | Amperage mA | Kelvin | Total Lumen | Weight (kg) | Packing | MOQ |
|-----------|---------------|-------------------------|------|----------------|--------|-------------|----------------|---------|-----|
| 145-56140 | 5207227026119 | 595 x 295 x 32 | 30 | 360 | 6500 | 3150 | 0.742 | 1\10 | 1 |
| 145-56141 | 5207227026133 | 595 x 295 x 32 | 30 | 360 | 4000 | 3150 | 0.742 | 1\10 | 1 |
| 145-56142 | 5207227123108 | 595 x 295 x 32 | 30 | 360 | 3000 | 3150 | 0.742 | 1\10 | 1 |



Λευκό / White

60X60 UGR19



LED Type SMD2835 • Chip Brand Samsung • Volt 220-240V 50/60Hz • Output Volt 130V DC
 Start Time 0,5sec • PF > 0,90 • Operating Temperature -20°C / +40°C
 Installation Height 3-4m • Connection Καλώδιο / Wire
 Production Material Αλουμίνιο & Πλαστικό / Aluminium & Plastic

| | | | | |
|-----------------------------|------------------|--------------------|--------------|------------------|
| LUMEN / WATT lm/W 105 | CRI Ra >80 | BEAM ANGLE 120° | NON DIMMABLE | 3 YEARS WARRANTY |
|-----------------------------|------------------|--------------------|--------------|------------------|

| Code | Barcode | Dimension (mm) ↕ ↔ ↘ | Watt | Amperage mA | Kelvin | Total Lumen | Weight (kg) | Packing | MOQ |
|-----------|---------------|-------------------------|------|----------------|--------|-------------|----------------|---------|-----|
| 145-56143 | 5207227123115 | 595 x 595 x 32 | 48 | 360 | 6500 | 5040 | 1.197 | 1\10 | 1 |
| 145-56144 | 5207227123139 | 595 x 595 x 32 | 48 | 360 | 4000 | 5040 | 1.197 | 1\10 | 1 |
| 145-56145 | 5207227123146 | 595 x 595 x 32 | 48 | 360 | 3000 | 5040 | 1.197 | 1\10 | 1 |

ΑΝΤΑΛΛΑΚΤΙΚΟ DRIVER / SPARE DRIVER: 145-56186



Λευκό / White

120X30 UGR19



LED Type SMD2835 • Chip Brand Samsung • Volt 220-240V 50/60Hz • Output Volt 130V DC
 Start Time 0,5sec • PF > 0,90 • Operating Temperature -20°C / +40°C
 Installation Height 3-4m • Connection Καλώδιο / Wire
 Production Material Αλουμίνιο & Πλαστικό / Aluminium & Plastic

| | | | | |
|-----------------------------|------------------|--------------------|--------------|------------------|
| LUMEN / WATT lm/W 105 | CRI Ra >80 | BEAM ANGLE 120° | NON DIMMABLE | 3 YEARS WARRANTY |
|-----------------------------|------------------|--------------------|--------------|------------------|

| Code | Barcode | Dimension (mm) ↕ ↔ ↘ | Watt | Amperage mA | Kelvin | Total Lumen | Weight (kg) | Packing | MOQ |
|-----------|---------------|-------------------------|------|----------------|--------|-------------|----------------|---------|-----|
| 145-56146 | 5207227123153 | 1195 x 295 x 32 | 45 | 360 | 6500 | 4725 | 1.623 | 1\5 | 1 |
| 145-56147 | 5207227123177 | 1195 x 295 x 32 | 45 | 360 | 4000 | 4725 | 1.623 | 1\5 | 1 |
| 145-56148 | 5207227123092 | 1195 x 295 x 32 | 45 | 360 | 3000 | 4725 | 1.623 | 1\5 | 1 |

ΑΝΤΑΛΛΑΚΤΙΚΟ DRIVER / SPARE DRIVER: 145-56186



30X60 UGR19



Λευκό / White

30.000h

ON
OFF
25.000

IP40

CLASS I

IK02

F



LED Type SMD2835 · Chip Brand Samsung · Volt 220-240V 50/60Hz · Output Volt 110V DC
Start Time 0,5sec · PF > 0,90 · Operating Temperature -20°C / +40°C
Installation Height 3-4m · Connection Καλώδιο / Wire
Production Material Αλουμίνιο & Πλαστικό / Aluminium & Plastic

| | | | | |
|-----------------------------|------------------|--------------------|-----------------|------------------------|
| LUMEN / WATT lm/W 105 | CRI Ra >80 | BEAM ANGLE 120° | NON DIMMABLE | 3 YEARS WARRANTY |
|-----------------------------|------------------|--------------------|-----------------|------------------------|

| Code | Barcode | Dimension (mm) ↗ ↔ ↘ | Watt | Amperage mA | Kelvin | Total Lumen | Weight (kg) | Packing | MOQ |
|-----------|---------------|-------------------------|------|----------------|--------|-------------|----------------|---------|-----|
| 145-56150 | 5207227159206 | 600 x 300 x 46 | 30 | 360 | 6500 | 3150 | 1.184 | 1\5 | 1 |
| 145-56151 | 5207227159220 | 600 x 300 x 46 | 30 | 360 | 4000 | 3150 | 1.184 | 1\5 | 1 |
| 145-56152 | 5207227159244 | 600 x 300 x 46 | 30 | 360 | 3000 | 3150 | 1.184 | 1\5 | 1 |

SYMBATO DRIVER / COMPATIBLE DRIVER: DALI 145-56291



60X60 UGR19



Λευκό / White

30.000h

ON
OFF
25.000

IP40

CLASS I

IK02

F



LED Type SMD2835 · Chip Brand Samsung · Volt 220-240V 50/60Hz · Output Volt 130V DC
Start Time 0,5sec · PF > 0,90 · Operating Temperature -20°C / +40°C
Installation Height 3-4m · Connection Καλώδιο / Wire
Production Material Αλουμίνιο & Πλαστικό / Aluminium & Plastic

| | | | | |
|-----------------------------|------------------|--------------------|-----------------|------------------------|
| LUMEN / WATT lm/W 105 | CRI Ra >80 | BEAM ANGLE 120° | NON DIMMABLE | 3 YEARS WARRANTY |
|-----------------------------|------------------|--------------------|-----------------|------------------------|

| Code | Barcode | Dimension (mm) ↗ ↔ ↘ | Watt | Amperage mA | Kelvin | Total Lumen | Weight (kg) | Packing | MOQ |
|-----------|---------------|-------------------------|------|----------------|--------|-------------|----------------|---------|-----|
| 145-56153 | 5207227159268 | 600 x 600 x 46 | 48 | 360 | 6500 | 5040 | 1.763 | 1\7 | 1 |
| 145-56154 | 5207227159282 | 600 x 600 x 46 | 48 | 360 | 4000 | 5040 | 1.763 | 1\7 | 1 |
| 145-56155 | 5207227159305 | 600 x 600 x 46 | 48 | 360 | 3000 | 5040 | 1.763 | 1\7 | 1 |

SYMBATO DRIVER / COMPATIBLE DRIVER: DALI 145-56291 ANΤΑΛΛΑΚΤΙΚΟ DRIVER / SPARE DRIVER: 145-56186



120X30 UGR19



Λευκό / White

30.000h

ON
OFF
25.000

IP40

CLASS I

IK02

F



LED Type SMD2835 · Chip Brand Samsung · Volt 220-240V 50/60Hz · Output Volt 130V DC
Start Time 0,5sec · PF > 0,90 · Operating Temperature -20°C / +40°C
Installation Height 3-4m · Connection Καλώδιο / Wire
Production Material Αλουμίνιο & Πλαστικό / Aluminium & Plastic

| | | | | |
|-----------------------------|------------------|--------------------|-----------------|------------------------|
| LUMEN / WATT lm/W 105 | CRI Ra >80 | BEAM ANGLE 120° | NON DIMMABLE | 3 YEARS WARRANTY |
|-----------------------------|------------------|--------------------|-----------------|------------------------|

| Code | Barcode | Dimension (mm) ↗ ↔ ↘ | Watt | Amperage mA | Kelvin | Total Lumen | Weight (kg) | Packing | MOQ |
|-----------|---------------|-------------------------|------|----------------|--------|-------------|----------------|---------|-----|
| 145-56156 | 5207227159329 | 1200 x 300 x 46 | 45 | 360 | 6500 | 4725 | 2.062 | 1\5 | 1 |
| 145-56157 | 5207227159343 | 1200 x 300 x 46 | 45 | 360 | 4000 | 4725 | 2.062 | 1\5 | 1 |
| 145-56158 | 5207227159367 | 1200 x 300 x 46 | 45 | 360 | 3000 | 4725 | 2.062 | 1\5 | 1 |

SYMBATO DRIVER / COMPATIBLE DRIVER: DALI 145-56291 ANΤΑΛΛΑΚΤΙΚΟ DRIVER / SPARE DRIVER: 145-56186



ΣΥΝΔΥΑΖΕΤΑΙ ΜΕ / COMBINED WITH:

145-56160 / 145-56161 / 145-56162 / 145-56163 / 145-56164 / 145-56165
145-56170 / 145-56171 / 145-56172 / 145-56173 / 145-56174 / 145-56175

LIFUD
LED Driver

Λευκό / White

Τροφοδοτικό / Driver Dimmable 40W



FLICKER
FREE



25.000h

ON
OFF

15.000



IP20



CLASS II



Volt 100-240V 50/60Hz • Output Volt 25-42V DC • PF > 0,95 • Operating Temperature -25°C / +70°C
Connection Καλώδιο / Wire • Production Material Πλαστικό / Plastic

| Code | Barcode | Dimension (mm) ↕ ↔ ↕ | Watt | Amperage mA | Weight (kg) | Packing | MOQ |
|-----------|---------------|-------------------------|------|---------------------------|----------------|---------|-----|
| 145-56195 | 5206139044532 | 140 x 65 x 30 | 40 | 800/850/900/950/1000/1050 | 0.150 | 1\50 | 1 |



ΣΥΝΔΥΑΖΕΤΑΙ ΜΕ / COMBINED WITH:

145-56160 / 145-56161 / 145-56162 / 145-56163 / 145-56164 /
145-56165 / 145-56170 / 145-56171 / 145-56172 / 145-56173 /
145-56174 / 145-56175 / 145-56320 / 145-56321 / 145-56322
/ 145-56323 / 145-56324 / 145-56325 / 145-56310 /
145-56311 / 145-56312 / 145-56313 / 145-56314 / 145-56315 /
145-56330 / 145-56331 / 145-56332 / 145-56333 / 145-56334
/ 145-56335 / 145-56350 / 145-56351



LIFUD
LED Driver

Λευκό / White

Τροφοδοτικό / Driver Dimmable 40W & 42VDC



FLICKER
FREE



50.000h

ON
OFF

10.000



IP20



CLASS II



Volt 198-264V 50/60Hz • Output Volt 9-42V DC (700/750/800/850/900/950/1000mA), 9-40V DC (1050mA)
Operating Temperature -20°C / +40°C • Connection Καλώδιο / Wire • Production Material Πλαστικό / Plastic

| Code | Barcode | Dimension (mm) ↕ ↔ ↕ | Watt | Amperage mA | Weight (kg) | Packing | MOQ |
|-----------|---------------|-------------------------|--------|---------------------------|----------------|---------|-----|
| 145-56188 | 5207227395185 | 142 x 46 x 27,5 | 40 MAX | 800/850/900/950/1000/1050 | 0.123 | 1\50 | 1 |



ΣΥΝΔΥΑΖΕΤΑΙ ΜΕ / COMBINED WITH:

145-56160 / 145-56161 / 145-56162 / 145-56163 / 145-56164 /
145-56165 / 145-56170 / 145-56171 / 145-56172 / 145-56173 /
145-56174 / 145-56175 / 145-56320 / 145-56321 / 145-56322
/ 145-56323 / 145-56324 / 145-56325 / 145-56310 /
145-56311 / 145-56312 / 145-56313 / 145-56314 / 145-56315 /
145-56330 / 145-56331 / 145-56332 / 145-56333 / 145-56334
/ 145-56335 / 145-56350 / 145-56351

LIFUD
LED Driver

Λευκό / White

Τροφοδοτικό / Driver Dimmable 40W 0-10V



FLICKER
FREE



50.000h

ON
OFF

10.000



IP20



CLASS II



Volt 198-264V 50/60Hz • Output Volt 25-42V DC (800/850/900/950mA), 25-40V DC (1000mA), 25-38V DC (1050mA)
Operating Temperature -20°C / +40°C • Connection Καλώδιο / Wire • Production Material Πλαστικό / Plastic

| Code | Barcode | Dimension (mm) ↕ ↔ ↕ | Watt | Amperage mA | Weight (kg) | Packing | MOQ |
|-----------|---------------|-------------------------|--------|---------------------------|----------------|---------|-----|
| 145-56187 | 5207227395161 | 142 x 46 x 27,5 | 40 MAX | 800/850/900/950/1000/1050 | 0.110 | 1\50 | 1 |



ΣΥΝΔΥΑΖΕΤΑΙ ΜΕ / COMBINED WITH:

145-56230 / 145-56231 / 145-56232 / 145-56233 / 145-56234 / 145-56235
 145-56240 / 145-56241 / 145-56242 / 145-56250 / 145-56251 / 145-56252
 145-56150 / 145-56151 / 145-56152 / 145-56153 / 145-56154 / 145-56155 / 145-56156 / 145-56157 / 145-56158

powered by
TRIDONIC

Ασημί/ Silver

Τροφοδοτικό / Driver



Volt 220-240V 50/60Hz • Output Volt 126V DC • PF > 0,95 • Operating Temperature -20°C / +40°C
 Connection Καλώδιο / Wire • Production Material Μεταλλικό / Metal

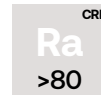

| Code | Barcode | Dimension (mm) ↗ ↔ ↘ | Watt | Amperage mA | Weight (kg) | Packing | MOQ |
|-----------|---------------|-------------------------|------|----------------|----------------|---------|-----|
| 145-56290 | 5207227202407 | 230 x 30 x 20 | 50 | 350 | 0.155 | 1\50 | 1 |

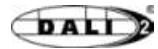

ΣΥΝΔΥΑΖΕΤΑΙ ΜΕ / COMBINED WITH:

145-56230 / 145-56231 / 145-56232 / 145-56233 / 145-56234 / 145-56235
 145-56240 / 145-56241 / 145-56242 / 145-56250 / 145-56251 / 145-56252
 145-56150 / 145-56151 / 145-56152 / 145-56153 / 145-56154 / 145-56155 / 145-56156 / 145-56157 / 145-56158



| Code | Barcode | Dimension (mm) ↗ ↔ ↘ | Watt | Amperage mA | Weight (kg) | Packing | MOQ |
|-----------|---------------|-------------------------|------|----------------|----------------|---------|-----|
| 145-56291 | 5207227202414 | 230 x 30 x 20 | 50 | 350 | 0.155 | 1\50 | 1 |



ΣΥΝΔΥΑΖΕΤΑΙ ΜΕ / COMBINED WITH:

145-56143 / 145-56144 / 145-56145 / 145-56146 / 145-56147 / 145-56148
 145-56153 / 145-56154 / 145-56155 / 145-56156 / 145-56157 / 145-56158

Λευκό / White

Ανταλλακτικό Τροφοδοτικό LED Spare Part LED Driver



Volt 175-265V 50/60Hz • Output Volt 130V DC • Operating Temperature -20°C / +40°C
 Connection Καλώδιο / Wire • Production Material Πλαστικό / Plastic

| Code | Barcode | Dimension (mm) ↗ ↔ ↘ | Watt | Amperage mA | Weight (kg) | Packing | MOQ |
|-----------|---------------|-------------------------|-------|-----------------|----------------|---------|-----|
| 145-56186 | 5207227283123 | 116 x 40 x 30 | 48-45 | 200/250/300/350 | 0.130 | 1\50 | 1 |

Εξάρτημα στήριξης για κρεμαστό φωτιστικό Metal suspending wire

Production Material: Μεταλλικό/ Metal

| Code | Barcode | Color | Weight (kg) | Packing | MOQ |
|-----------|---------------|--------|-------------|---------|-----|
| 145-56190 | 5206139052278 | SILVER | 0.065 | 1\100 | 1 |



Εξάρτημα στήριξης γυψοσανίδας Σετ (CLIP) Spring fastener Set (CLIP)

Production Material: Μεταλλικό/ Metal

| Code | Barcode | Color | Weight (kg) | Packing | MOQ |
|-----------|---------------|--------|-------------|---------|-----|
| 145-56191 | 5207227058615 | SILVER | 0.065 | 1\100 | 1 |



Εξάρτημα στήριξης γυψοσανίδας & backlight Σετ (CLIP) Spring fastener & led backlight Set (CLIP)

Production Material: Μεταλλικό/ Metal

| Code | Barcode | Color | Weight (kg) | Packing | MOQ |
|-----------|---------------|--------|-------------|---------|-----|
| 145-56192 | 5207227158827 | SILVER | 0.065 | 1\100 | 1 |



Εξωτερική βάση - Surface base 60X60 για backlight

Production Material: Αλουμίνιο & Πλαστικό / Aluminium & Plastic

| Code | Barcode | Dimension (mm) | | | Color | Weight (kg) | Packing | MOQ |
|-----------|---------------|----------------|-----|----|-------|-------------|---------|-----|
| | | ↗ | ↔ | ↕ | | | | |
| 145-56196 | 5207227026188 | 600 | 600 | 43 | WHITE | 0.400 | 1\20 | 1 |
| 145-56390 | 5207227280177 | 600 | 600 | 63 | WHITE | 0.560 | 1\20 | 1 |
| 145-56392 | 5207227385933 | 600 | 600 | 63 | BLACK | 0.730 | 1\20 | 1 |

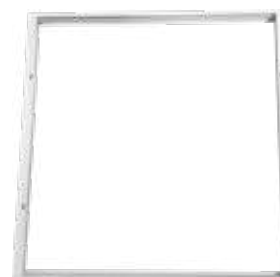

Βάση / Base Backlight
Βάθος / Depth 6,3cm

Εξωτερική βάση - Surface base 120X30 για backlight

Production Material: Αλουμίνιο & Πλαστικό / Aluminium & Plastic

| Code | Barcode | Dimension (mm) | | | Color | Weight (kg) | Packing | MOQ |
|-----------|---------------|----------------|-----|----|-------|-------------|---------|-----|
| | | ↗ | ↔ | ↕ | | | | |
| 145-56197 | 5207227031298 | 1200 | 300 | 43 | WHITE | 0,500 | 1\20 | 1 |
| 145-56391 | 5207227280191 | 1200 | 300 | 63 | WHITE | 0.730 | 1\20 | 1 |
| 145-56393 | 5207227385957 | 1200 | 300 | 63 | BLACK | 0.730 | 1\20 | 1 |



Βάση / Base Backlight
Βάθος / Depth 6,3cm

Στεφάνι υποστήριξης - Frame adaptor 62,5x62,5

Production Material: Αλουμίνιο/ Aluminium

| Code | Barcode | Dimension ↗ (mm) ↔ | Color | Weight (kg) | Packing | MOQ |
|-----------|---------------|-----------------------|--------|-------------|---------|-----|
| 145-68095 | 5207227060335 | 625 x 625 | SILVER | 0.210 | 1 | 1 |

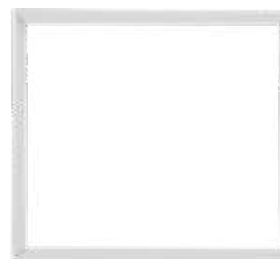



Φωτιστικά Χωνευτά
LED SMD & COB

LED SMD & COB
Recessed Fixtures



○ Λευκό / White

Spot Ø30 1W 12V



LED Type COB · Chip Brand Bridgelux · Volt DC 12V 50/60Hz · Output Volt 12V DC
 Start Time 0,5 sec · Operating Temperature -10°C / +60°C
 Installation Height 2-3m · Connection Καλώδιο / Wire
 Production Material Αλουμίνιο & Πλαστικό / Aluminium & Plastic

| | | | | |
|-----------------------------|------------------|-------------------|--------------|------------------|
| LUMEN / WATT lm/W 100 | CRI Ra >80 | BEAM ANGLE 12° | NON DIMMABLE | 2 YEARS WARRANTY |
|-----------------------------|------------------|-------------------|--------------|------------------|

| Code | Barcode | Dimension Ø (mm) † | Watt | Kelvin | Total Lumen | Weight (kg) | Packing | MOQ |
|-----------|---------------|-----------------------|------|--------|-------------|----------------|---------|-----|
| 145-68910 | 5207227282683 | 30 x 25 | 1 | 6500 | 100 | 0.150 | 9\90 | 9 |
| 145-68911 | 5207227282690 | 30 x 25 | 1 | 4000 | 100 | 0.150 | 9\90 | 9 |
| 145-68912 | 5207227282706 | 30 x 25 | 1 | 3000 | 100 | 0.150 | 9\90 | 9 |



3CCT

3000K 4000K 6500K



○ Λευκό / White

Γυψοσανίδας / Plaster Board Ø85



LED Type COB · Chip Brand Bridgelux · Volt 220-240V 50/60Hz · Output Volt 33-40V DC
 Start Time 0,5 sec · PF >0,50 · Operating Temperature -10°C / +60°C
 Installation Height 2-3m · Connection Καλώδιο / Wire
 Production Material Αλουμίνιο & Πλαστικό / Aluminium & Plastic

| | | | | |
|-----------------------------|------------------|-------------------|--------------|------------------|
| LUMEN / WATT lm/W 100 | CRI Ra >80 | BEAM ANGLE 60° | NON DIMMABLE | 5 YEARS WARRANTY |
|-----------------------------|------------------|-------------------|--------------|------------------|

| Code | Barcode | Dimension Ø (mm) † | Watt | Amperage mA | Kelvin | Total Lumen | Weight (kg) | Packing | MOQ |
|-----------|---------------|-----------------------|------|----------------|--------|-------------|----------------|---------|-----|
| 145-65100 | 5207227282812 | 85 x 85 | 9 | 200 | 3CCT | 900 | 0.400 | 1\20 | 1 |



3CCT

3000K 4000K 6500K



○ Λευκό / White

Στεγανό Ø88 3CCT



LED Type COB · Chip Brand Bridgelux · Volt 220-240V 50/60Hz · Output Volt 25-42V DC
 Start Time 0,5 sec · PF >0,50 · Operating Temperature -10°C / +60°C
 Installation Height 2-3m · Connection Καλώδιο / Wire
 Production Material Αλουμίνιο & Πλαστικό / Aluminium & Plastic

| | | | | |
|-----------------------------|------------------|-------------------|--------------|------------------|
| LUMEN / WATT lm/W 100 | CRI Ra >80 | BEAM ANGLE 60° | NON DIMMABLE | 5 YEARS WARRANTY |
|-----------------------------|------------------|-------------------|--------------|------------------|

| Code | Barcode | Dimension Ø (mm) † | Watt | Amperage mA | Kelvin | Total Lumen | Weight (kg) | Packing | MOQ |
|-----------|---------------|-----------------------|------|----------------|--------|-------------|----------------|---------|-----|
| 145-68902 | 5207227282676 | 88 x 60 | 7 | 180 | 3CCT | 700 | 0.400 | 1\20 | 1 |

**4CCT**

2700K 3000K 4000K 6500K

Πυράντοχο για 90 λεπτά
Fire Rated 90min

 Άσπρο - Μαύρο Περιβλήμα
White - Black Housing
**Στεγανό Ø90 4CCT**

LED Type SMD2835 • Chip Brand MTC • Volt 220-240V 50/60Hz • Output Volt 60-100V
Start Time 0,5 sec • PF >0,93 • Operating Temperature -20°C / +45°C
Installation Height 2-3m • Connection Push fit terminal / Ταχεία σύνδεση
Production Material Αλουμίνιο - Πλαστικό / Aluminium - Plastic

LUMEN / WATT
lm/W
110

CRI
Ra
>80

BEAM ANGLE
60°

DIMMABLE

5
YEARS
WARRANTY

| Code | Barcode | Dimension Ø (mm) ↓ | Watt | Amperage mA | Kelvin | Total Lumen | Weight (kg) | Packing | MOQ |
|-----------|---------------|-----------------------|-------|----------------|--------|-------------|----------------|---------|-----|
| 145-68900 | 5207227271151 | 90 x 45 | 5 / 8 | 60 / 100 | 4CCT | 880 | 0.242 | 1\48 | 1 |



NEW

3CCT

2700K 3000K 4000K

 Άσπρο - Μαύρο Περιβλήμα
White - Black Housing
**Στεγανό Ø87 TRIAC**

LED Type SMD2835 • Chip Brand Bridgelux • Volt 220-240V 50/60Hz • Output Volt 257V DC
Start Time 0,5 sec • PF >0.60 • Operating Temperature -10°C / +40°C
Installation Height 2-3m • Connection Καλώδιο / Wire
Production Material Αλουμίνιο - Πλαστικό / Aluminium - Plastic

LUMEN / WATT
lm/W
100

CRI
Ra
>80

BEAM ANGLE
38°

DIMMABLE

3
YEARS
WARRANTY

| Code | Barcode | Dimension Ø (mm) ↓ | Watt | Amperage mA | Kelvin | Total Lumen | Weight (kg) | Packing | MOQ |
|-----------|---------------|-----------------------|------|----------------|--------|-------------|----------------|---------|-----|
| 145-68905 | 5207227455605 | 87 x 47 | 5.5 | 17 | 3CCT | 550 | 0.100 | 1/48 | 1 |



NEW

3CCT

2700K 3000K 4000K

 Λευκό / White
**Ø87 TRIAC 3CCT
Στεγανό με Connection Box**

LED Type SMD2835 • Chip Brand Bridgelux • Volt 220-240V 50/60Hz • Output Volt 265V DC
Start Time 0,5 sec • PF >0.60 • Operating Temperature -10°C / +40°C
Installation Height 2-3m • Connection Καλώδιο / Wire
Production Material Αλουμίνιο - Πλαστικό / Aluminium - Plastic

LUMEN / WATT
lm/W
100

CRI
Ra
>81

BEAM ANGLE
38°

DIMMABLE

3
YEARS
WARRANTY

| Code | Barcode | Dimension Ø (mm) ↓ | Watt | Amperage mA | Kelvin | Total Lumen | Weight (kg) | Packing | MOQ |
|-----------|---------------|-----------------------|------|----------------|--------|-------------|----------------|---------|-----|
| 145-68906 | 5207227455629 | 87 x 45.5 | 5.5 | 17 | 3CCT | 550 | 0.130 | 1/48 | 1 |



LIFUD
LED Driver

○ Λευκό / White

COB Ø40 5W / Ø60 12W / Ø70 18W



LED Type COB • Chip Brand Bridgelux • Volt 220-240V 50/60Hz • Output Volt 25-42V DC
Start Time 0,5 sec • PF >0,50 • Operating Temperature -10°C / +60°C
Installation Height 2-3m • Connection Καλώδιο / Wire
Production Material Αλουμίνιο & Πλαστικό / Aluminium & Plastic

LUMEN / WATT
lm/W
100

CRI
Ra
>80

BEAM ANGLE
36°

NON DIMMABLE

5 YEARS WARRANTY

| Code | Barcode | Dimension Ø (mm) ↓ | Cutting Hole (mm) | Watt | Amperage mA | Kelvin | Total Lumen | Weight (kg) | Packing | MOQ |
|-----------|---------------|--------------------|-------------------|------|-------------|--------|-------------|-------------|---------|-----|
| 145-65011 | 5207227282751 | 40 x 50 | 35 | 5 | 135 | 4000 | 500 | 0.150 | 1\50 | 1 |
| 145-65012 | 5207227282768 | 40 x 50 | 35 | 5 | 135 | 3000 | 500 | 0.150 | 1\50 | 1 |
| 145-65014 | 5207227282713 | 60 x 60 | 55 | 12 | 300 | 4000 | 1200 | 0.250 | 1\50 | 1 |
| 145-65015 | 5207227282720 | 60 x 60 | 55 | 12 | 300 | 3000 | 1200 | 0.250 | 1\50 | 1 |
| 145-65017 | 5207227282744 | 75 x 75 | 70 | 18 | 450 | 4000 | 1800 | 0.550 | 1\20 | 1 |
| 145-65018 | 5207227282737 | 75 x 75 | 70 | 18 | 450 | 3000 | 1800 | 0.550 | 1\20 | 1 |



EAGLERISE
LED Driver

145-59801 ○ Λευκό / White

145-59802 ● Μαύρο / Black

SMD Κινητό / Movable Ø84 12W



LED Type SMD2835 • Chip Brand Cree • Volt 220-240V 50/60Hz
Start Time 0,5 sec • PF >0,50 • Operating Temperature -20°C / +45°C
Installation Height 3 - 4m • Connection Κλέμμα / Terminal Block
Production Material Πλαστικό - Αλουμίνιο / Plastic - Aluminium

LUMEN / WATT
lm/W
85

CRI
Ra
>80

BEAM ANGLE
24°

NON DIMMABLE

2 YEARS WARRANTY

| | Barcode | Dimension (mm) ↗ ↖ ↓ | Watt | Amperage mA | Kelvin | Total Lumen | Weight (kg) | Packing | MOQ |
|-----------|---------------|----------------------|------|-------------|--------|-------------|-------------|---------|-----|
| 145-59801 | 5207227151132 | 100 x 100 x 84 | 12 | 250 | 4000 | 1020 | 1.100 | 1\20 | 1 |
| 145-59802 | 5207227151149 | 100 x 100 x 84 | 12 | 250 | 4000 | 1020 | 1.100 | 1\20 | 1 |





LIFUD
LED Driver

Λευκό / White

Ø90 12W Με Κινητή Βάση / With Movable Base



LED Type COB · Chip Brand Bridgelux · Volt 220-240V 50/60Hz · Output Volt 33-40V DC
Start Time 0,5 sec · PF >0,50 · Operating Temperature -10°C / +60°C
Installation Height 2-3m · Connection Καλώδιο / Wire
Production Material Αλουμίνιο & Πλαστικό / Aluminium & Plastic

LUMEN / WATT
lm/W
100

CRI
Ra
>80

BEAM ANGLE
36°

NON
DIMMABLE

5
YEARS
WARRANTY

| | Barcode | Dimension Ø (mm) ↓ | Cutting Hole (mm) | Watt | Amperage mA | Kelvin | Total Lumen | Weight (kg) | Packing | MOQ |
|-----------|---------------|-----------------------|----------------------|------|----------------|--------|-------------|----------------|---------|-----|
| 145-65020 | 5207227282775 | 110 x 120 | 90 | 12 | 300 | 4000 | 1200 | 0.450 | 1\20 | 1 |
| 145-65021 | 5207227282782 | 110 x 120 | 90 | 12 | 300 | 3000 | 1200 | 0.450 | 1\20 | 1 |



3CCT

3000K 4000K 6500K

LIFUD
LED Driver

Λευκό / White

Ø95 12W / Ø110 30W Με Κινητή Βάση / With Movable Base



LED Type COB · Chip Brand Bridgelux · Volt 220-240V 50/60Hz · Output Volt 33-40V DC
Start Time 0,5 sec · PF >0,50 · Operating Temperature -10°C / +60°C
Installation Height 2-3m · Connection Καλώδιο / Wire
Production Material Αλουμίνιο & Πλαστικό / Aluminium & Plastic

LUMEN / WATT
lm/W
100

CRI
Ra
>80

BEAM ANGLE
36°

NON
DIMMABLE

5
YEARS
WARRANTY

| | Barcode | Dimension Ø (mm) ↓ | Cutting Hole (mm) | Watt | Amperage mA | Kelvin | Total Lumen | Weight (kg) | Packing | MOQ |
|-----------|---------------|-----------------------|----------------------|------|----------------|--------|-------------|----------------|---------|-----|
| 145-65022 | 5207227282799 | 110 x 120 | 95 | 20 | 500 | 3CCT | 2000 | 0.500 | 1\20 | 1 |
| 145-65023 | 5207227282805 | 134 x 120 | 110 | 30 | 750 | 3CCT | 3000 | 0.900 | 1\20 | 1 |





3 CCT

3000K 4000K 6500K

LIFUD
LED Driver

Λευκό / White

SMD Ø130 15W / Ø165 25W / Ø220 40W 3CCT



LED Type COB • Chip Brand Bridgelux • Volt 220-240V 50/60Hz • Output Volt 33-40V DC
Start Time 0,5 sec • PF >0,50 & >0,90 • Operating Temperature -10°C / +60°C
Installation Height 2-3m • Connection Καλώδιο / Wire
Production Material Αλουμίνιο & Πλαστικό / Aluminium & Plastic

LUMEN / WATT
lm/W
100

CRI
Ra
>80

BEAM ANGLE
60°

NON DIMMABLE

5 YEARS WARRANTY

| Code | Barcode | Dimension Ø (mm) † | Cutting Hole (mm) | Watt | Amperage mA | Kelvin | Total Lumen | Weight (kg) | Packing | MOQ |
|-----------|---------------|--------------------|-------------------|------|-------------|--------|-------------|-------------|---------|-----|
| 145-65200 | 5207227282843 | 130 x 68 | 110 | 15 | 400 | 3CCT | 1500 | 0.500 | 1\20 | 1 |
| 145-65201 | 5207227282829 | 165 x 90 | 145 | 25 | 600 | 3CCT | 2500 | 0.650 | 1\20 | 1 |
| 145-65202 | 5207227282836 | 220 x 105 | 200 | 40 | 850 | 3CCT | 4000 | 1.150 | 1\10 | 1 |



3 CCT

3000K 4000K 6500K

LIFUD
LED Driver

Λευκό / White

COB Ø90 10W / Ø230 35W 3CCT



LED Type COB • Chip Brand Bridgelux • Volt 220-240V 50/60Hz • Output Volt 33-40V DC
Start Time 0,5 sec • PF >0,50 & >0,90 • Operating Temperature -10°C / +60°C
Installation Height 2-3m & 4-5m • Connection Καλώδιο / Wire
Production Material Αλουμίνιο & Πλαστικό / Aluminium & Plastic

LUMEN / WATT
lm/W
100

CRI
Ra
>80

BEAM ANGLE
60°

NON DIMMABLE

5 YEARS WARRANTY

| Code | Barcode | Dimension Ø (mm) † | Cutting Hole (mm) | Watt | Amperage mA | Kelvin | Total Lumen | Weight (kg) | Packing | MOQ |
|-----------|---------------|--------------------|-------------------|------|-------------|--------|-------------|-------------|---------|-----|
| 145-65210 | 5207227282850 | 90 x 42 | 75 | 10 | 250 | 3CCT | 1000 | 0.450 | 1\20 | 1 |
| 145-65211 | 5207227282867 | 225 x 100 | 200 | 35 | 700 | 3CCT | 3500 | 1.000 | 1\10 | 1 |





○ Λευκό / White

COB Ø220 30W



LED Type COB7660 • Chip Brand Sanan • Volt 170-265V 50/60Hz • Output Volt 96V DC
 Start Time 0,5 sec • PF >0,50 • Operating Temperature -20°C / +40°C
 Installation Height 3-4m • Connection Καλώδιο / Wire
 Production Material Αλουμίνιο & Πλαστικό / Aluminium & Plastic

| | | | | |
|----------------------------|------------------|--------------------|--------------|------------------|
| LUMEN / WATT lm/W 90 | CRI Ra >80 | BEAM ANGLE 120° | NON DIMMABLE | 2 YEARS WARRANTY |
|----------------------------|------------------|--------------------|--------------|------------------|

| Code | Barcode | Dimension Ø (mm) † | Cutting Hole (mm) | Watt | Amperage mA | Kelvin | Total Lumen | Weight (kg) | Packing | MOQ |
|-----------|---------------|--------------------|-------------------|------|-------------|--------|-------------|-------------|---------|-----|
| 145-68201 | 5206139025081 | 220 x 52 | 200 | 30 | 245 | 6500 | 2700 | 0.470 | 1\20 | 1 |
| 145-68202 | 5206139098665 | 220 x 52 | 200 | 30 | 245 | 4000 | 2700 | 0.470 | 1\20 | 1 |



○ Λευκό / White

COB Ø220 55W



LED Type COB1428 • Chip Brand Sanan • Volt 85-265V 50/60Hz • Output Volt 108V DC
 Start Time 0,5 sec • PF >0,90 • Operating Temperature -20°C / +40°C
 Installation Height 4-6m • Connection Καλώδιο / Wire
 Production Material Αλουμίνιο & Πλαστικό / Aluminium & Plastic

| | | | | |
|----------------------------|------------------|-------------------|--------------|------------------|
| LUMEN / WATT lm/W 90 | CRI Ra >80 | BEAM ANGLE 50° | NON DIMMABLE | 2 YEARS WARRANTY |
|----------------------------|------------------|-------------------|--------------|------------------|

| Code | Barcode | Dimension Ø (mm) † | Cutting Hole (mm) | Watt | Amperage mA | Kelvin | Total Lumen | Weight (kg) | Packing | MOQ |
|-----------|---------------|--------------------|-------------------|------|-------------|--------|-------------|-------------|---------|-----|
| 145-68205 | 5207227008375 | 230 x 113 | 200 | 55 | 1500 | 6500 | 4950 | 1.690 | 1\10 | 1 |
| 145-68206 | 5207227002502 | 230 x 113 | 200 | 55 | 1500 | 4000 | 4950 | 1.690 | 1\10 | 1 |





Cutting Dimension
220x130mm

EAGLERISE
LED Driver

○ Λευκό / White

220x132x116.5cm

FLICKER
FREE

30.000h

ON
OFF
15.000

IP20

CLASS II

IK03

F

PRO
SERIES

LED Type SMD5730 · Chip Brand Epistar · Volt 220-240V 50/60Hz · Output Volt 27-45,5V DC
Start Time 0,5 sec · PF >0,95 · Operating Temperature -20°C / +50°C
Installation Height 4-5m · Connection Καλώδιο / Wire
Production Material Αλουμίνιο & Πλαστικό / Aluminium & Plastic

| | | | | |
|----------------------------|------------------|--------------------|-----------------|------------------------|
| LUMEN / WATT lm/W 90 | CRI Ra >80 | BEAM ANGLE 120° | NON DIMMABLE | 2 YEARS WARRANTY |
|----------------------------|------------------|--------------------|-----------------|------------------------|

| Code | Barcode | Dimension (mm) ↗ ↔ ↘ | Watt | Amperage mA | Kelvin | Total Lumen | Weight (kg) | Packing | MOQ |
|-----------|---------------|-------------------------|------|----------------|--------|-------------|----------------|---------|-----|
| 145-68252 | 5207227205743 | 235 x 145 x 116.5 | 35 | 600 | 4000 | 3150 | 1.275 | 1\8 | 1 |



Cutting Dimension
350x65mm

KGP
LED Driver

○ Άσπρο - Μαύρο Περιβλήμα
White - Black Housing

Γραμμικό Μονό
Linear Single Light

FLICKER
FREE

25.000h

ON
OFF
10.000

IP20

CLASS II

IK03

G

PRO
SERIES

LED Type SMD2835 · Chip Brand Bridgelux · Volt 220-240V 50/60Hz
Start Time 0,5 sec · PF >0,50 · Operating Temperature -20°C / +45°C
Installation Height 3 - 5m · Connection Κλέμμα / Terminal Block
Production Material Πλαστικό - Αλουμίνιο / Plastic - Aluminium

| | | | | |
|----------------------------|------------------|-------------------|-----------------|------------------------|
| LUMEN / WATT lm/W 90 | CRI Ra >80 | BEAM ANGLE 24° | NON DIMMABLE | 2 YEARS WARRANTY |
|----------------------------|------------------|-------------------|-----------------|------------------------|

| Code | Barcode | Dimension (mm) ↗ ↔ ↘ | Watt | Amperage mA | Kelvin | Total Lumen | Weight (kg) | Packing | MOQ |
|-----------|---------------|-------------------------|------|----------------|--------|-------------|----------------|---------|-----|
| 145-55092 | 5207227061660 | 361 x 85 x 40 | 12 | 265 | 4000 | 1080 | 0.420 | 1\20 | 1 |



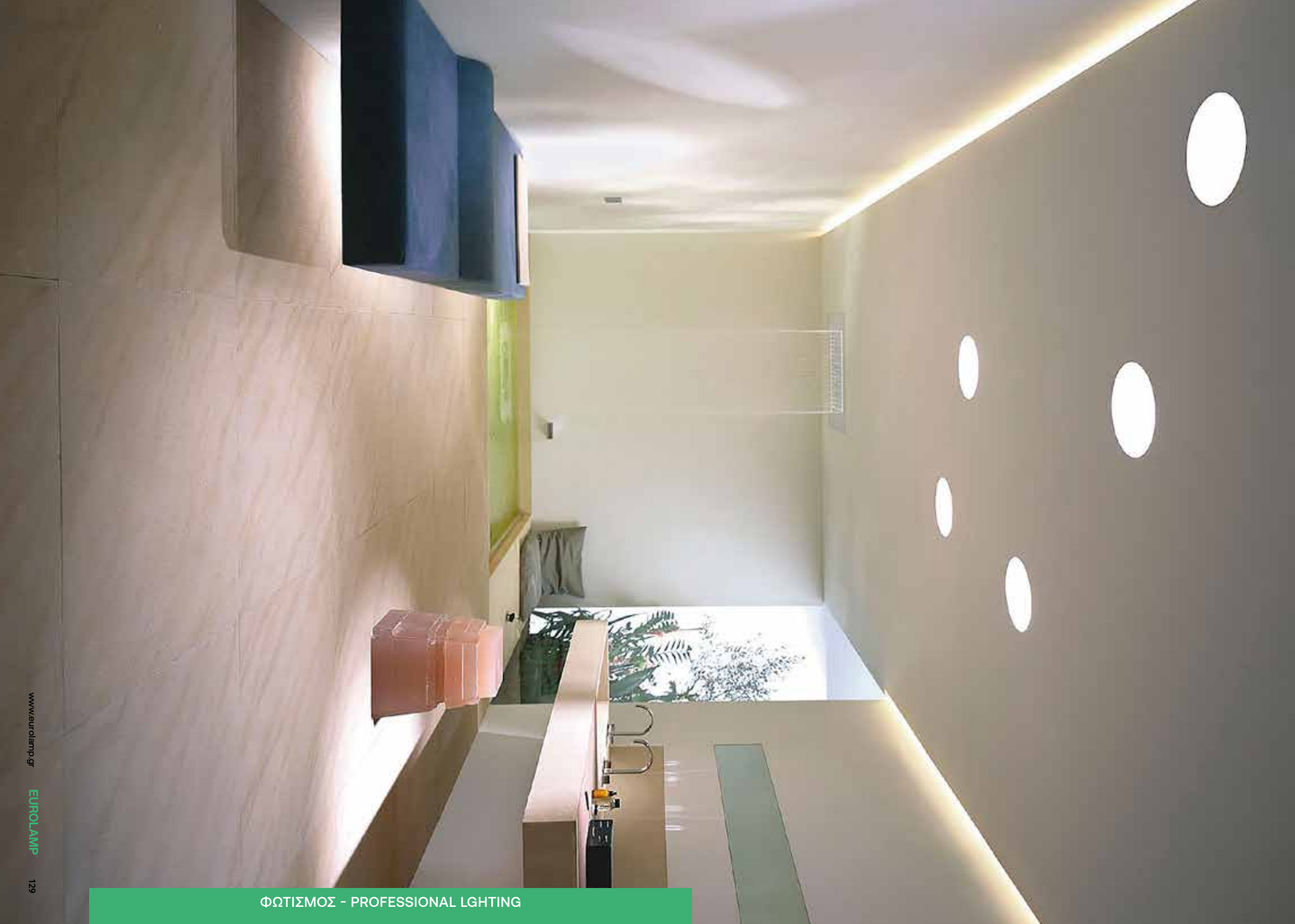



CUPOWER
LED Driver

Led Slim Ø85mm 3W



LED Type SMD2835 • Chip Brand Sanan • Volt 85-265V 50/60Hz • Output Volt 8-11V DC
Start Time 0,5 sec • PF >0,50 • Operating Temperature -10°C / +60°C
Installation Height 2-3m • Connection Καλώδιο / Wire
Production Material Αλουμίνιο & Πλαστικό / Aluminium & Plastic

| | | | | |
|----------------------------|------------------|--------------------|--------------|------------------|
| LUMEN / WATT lm/W 90 | CRI Ra >80 | BEAM ANGLE 120° | NON DIMMABLE | 2 YEARS WARRANTY |
|----------------------------|------------------|--------------------|--------------|------------------|

| Code | Barcode | Dimension Ø (mm) † | Color | Watt | Amperage mA | Kelvin | Total Lumen | Weight (kg) | Packing | MOQ |
|-----------|---------------|-----------------------|--------|------|----------------|--------|-------------|----------------|---------|-----|
| 145-68600 | 5206139014931 | 85 x 10,5 | WHITE | 3 | 300 | 6500 | 270 | 0.085 | 1\10\60 | 1 |
| 145-68601 | 5206139037190 | 85 x 10,5 | WHITE | 3 | 300 | 4000 | 270 | 0.085 | 1\10\60 | 1 |
| 145-68602 | 5207227020544 | 85 x 10,5 | WHITE | 3 | 300 | 3000 | 270 | 0.085 | 1\10\60 | 1 |
| 145-68620 | 5207227268779 | 85 x 10,5 | BLACK | 3 | 300 | 6500 | 270 | 0.085 | 1\10\60 | 1 |
| 145-68621 | 5207227268786 | 85 x 10,5 | BLACK | 3 | 300 | 4000 | 270 | 0.085 | 1\10\60 | 1 |
| 145-68622 | 5207227268793 | 85 x 10,5 | BLACK | 3 | 300 | 3000 | 270 | 0.085 | 1\10\60 | 1 |
| 145-68604 | 5206139037206 | 85 x 10,5 | SATINE | 3 | 300 | 4000 | 270 | 0.085 | 1\10\60 | 1 |





CUPOWER
LED Driver

○ Λευκό / White

Led Slim Ø120mm 6W



LED Type SMD2835 · Chip Brand Sanan · Volt 85-265V 50/60Hz · Output Volt 16-22V DC
Start Time 0,5 sec · PF >0,50 · Operating Temperature -10°C / +60°C
Installation Height 2-3m · Connection Καλώδιο / Wire
Production Material Αλουμίνιο & Πλαστικό / Aluminium & Plastic

| | | | | |
|----------------------------|------------------|--------------------|--------------|------------------|
| LUMEN / WATT lm/W 90 | CRI Ra >80 | BEAM ANGLE 120° | NON DIMMABLE | 2 YEARS WARRANTY |
|----------------------------|------------------|--------------------|--------------|------------------|

| Code | Barcode | Dimension Ø (mm) † | Cutting Hole (mm) | Watt | Amperage mA | Kelvin | Total Lumen | Weight (kg) | Packing | MOQ |
|-----------|---------------|--------------------|-------------------|------|-------------|--------|-------------|-------------|---------|-----|
| 145-68606 | 5207227020568 | 120 x 10,5 | 105 | 6 | 300 | 6500 | 540 | 0.120 | 1\40 | 1 |
| 145-68607 | 5207227124037 | 120 x 10,5 | 105 | 6 | 300 | 4000 | 540 | 0.120 | 1\40 | 1 |
| 145-68608 | 5207227020582 | 120 x 10,5 | 105 | 6 | 300 | 3000 | 540 | 0.120 | 1\40 | 1 |

Led Slim Ø145mm 9W

Output Volt 25-32V DC

| Code | Barcode | Dimension Ø (mm) † | Cutting Hole (mm) | Watt | Amperage mA | Kelvin | Total Lumen | Weight (kg) | Packing | MOQ |
|-----------|---------------|--------------------|-------------------|------|-------------|--------|-------------|-------------|---------|-----|
| 145-68609 | 5207227020605 | 145 x 10,5 | 130 | 9 | 300 | 6500 | 810 | 0.170 | 1\20 | 1 |
| 145-68610 | 5207227124051 | 145 x 10,5 | 130 | 9 | 300 | 4000 | 810 | 0.170 | 1\20 | 1 |
| 145-68611 | 5207227020629 | 145 x 10,5 | 130 | 9 | 300 | 3000 | 810 | 0.170 | 1\20 | 1 |

Led Slim Ø170mm 12W

Output Volt 35-42V DC

| Code | Barcode | Dimension Ø (mm) † | Cutting Hole (mm) | Watt | Amperage mA | Kelvin | Total Lumen | Weight (kg) | Packing | MOQ |
|-----------|---------------|--------------------|-------------------|------|-------------|--------|-------------|-------------|---------|-----|
| 145-68612 | 5207227020643 | 170 x 10,5 | 155 | 12 | 300 | 6500 | 1080 | 0.215 | 1\20 | 1 |
| 145-68613 | 5207227124075 | 170 x 10,5 | 155 | 12 | 300 | 4000 | 1080 | 0.215 | 1\20 | 1 |
| 145-68614 | 5207227020667 | 170 x 10,5 | 155 | 12 | 300 | 3000 | 1080 | 0.215 | 1\20 | 1 |



CUPOWER
LED Driver

Ø225 20W



LED Type SMD2835 · Chip Brand Sanan · Volt 85-265V 50/60Hz · Output Volt 55-65V DC
Start Time 0,5 sec · PF >0,50 · Operating Temperature -10°C / +60°C
Installation Height 2-3m · Connection Καλώδιο / Wire
Production Material Αλουμίνιο & Πλαστικό / Aluminium & Plastic

| | | | | |
|----------------------------|------------------|--------------------|--------------|------------------|
| LUMEN / WATT lm/W 90 | CRI Ra >80 | BEAM ANGLE 120° | NON DIMMABLE | 2 YEARS WARRANTY |
|----------------------------|------------------|--------------------|--------------|------------------|

| Code | Barcode | Dimension Ø (mm) † | Color | Watt | Amperage mA | Kelvin | Total Lumen | Weight (kg) | Packing | MOQ |
|-----------|---------------|-----------------------|-------|------|----------------|--------|-------------|----------------|---------|-----|
| 145-68000 | 5206139037824 | 225 x 10,5 | SATIN | 20 | 300 | 6500 | 1800 | 0.300 | 1\20 | 1 |
| 145-68001 | 5206139037213 | 225 x 10,5 | SATIN | 20 | 300 | 4000 | 1800 | 0.300 | 1\20 | 1 |
| 145-68010 | 5206139021427 | 225 x 10,5 | WHITE | 20 | 300 | 6500 | 1800 | 0.300 | 1\20 | 1 |
| 145-68011 | 5206139021434 | 225 x 10,5 | WHITE | 20 | 300 | 4000 | 1800 | 0.300 | 1\20 | 1 |
| 145-68012 | 5206139021441 | 225 x 10,5 | WHITE | 20 | 300 | 3000 | 1800 | 0.300 | 1\20 | 1 |

ΑΝΤΑΛΛΑΚΤΙΚΟ DRIVER / SPARE DRIVER: **145-68097** (2 YEARS GUARANTEE) / **145-68096** (3 YEARS GUARANTEE)

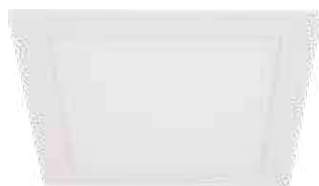

CUPOWER
LED Driver

○ Λευκό / White

225X225 20W



LED Type SMD2835 · Chip Brand Sanan · Volt 85-265V 50/60Hz · Output Volt 55-65V DC
Start Time 0,5 sec · PF >0,50 · Operating Temperature -10°C / +60°C
Installation Height 2-3m · Connection Καλώδιο / Wire
Production Material Αλουμίνιο & Πλαστικό / Aluminium & Plastic

| | | | | |
|----------------------------|------------------|--------------------|--------------|------------------|
| LUMEN / WATT lm/W 90 | CRI Ra >80 | BEAM ANGLE 120° | NON DIMMABLE | 2 YEARS WARRANTY |
|----------------------------|------------------|--------------------|--------------|------------------|

| Code | Barcode | Dimension (mm) ↗ ↔ † | Watt | Amperage mA | Kelvin | Total Lumen | Weight (kg) | Packing | MOQ |
|-----------|---------------|-------------------------|------|----------------|--------|-------------|----------------|---------|-----|
| 145-68020 | 5206139026224 | 225 x 225 x 10,5 | 20 | 300 | 6500 | 1800 | 0.360 | 1\20 | 1 |
| 145-68021 | 5206139098900 | 225 x 225 x 10,5 | 20 | 300 | 4000 | 1800 | 0.360 | 1\20 | 1 |
| 145-68022 | 5207227124099 | 225 x 225 x 10,5 | 20 | 300 | 3000 | 1800 | 0.360 | 1\20 | 1 |

ΑΝΤΑΛΛΑΚΤΙΚΟ DRIVER / SPARE DRIVER: **145-68097** (2 YEARS GUARANTEE) / **145-68096** (3 YEARS GUARANTEE)



CUPOWER
LED Driver

Λευκό / White

Ø225 20W



LED Type SMD2835 • Chip Brand Epistar • Volt 85-265V 50/60Hz • Output Volt 55-65V DC
Start Time 0,5 sec • PF >0,50 • Operating Temperature -10°C / +60°C
Installation Height 2-3m • Connection Καλώδιο / Wire
Production Material Αλουμίνιο & Πλαστικό / Aluminium & Plastic

| Code | Barcode | Dimension Ø (mm) † | Watt | Amperage mA | Kelvin | Lumen/Watt | Weight (kg) | Packing | MOQ |
|-----------|---------------|--------------------|------|-------------|--------|------------|-------------|---------|-----|
| 145-68400 | 5207227033551 | 225 x 10,5 | 20 | 300 | 6500 | 105 | 0.310 | 1\20 | 1 |
| 145-68401 | 5207227033568 | 225 x 10,5 | 20 | 300 | 4000 | 103 | 0.310 | 1\20 | 1 |
| 145-68402 | 5207227033575 | 225 x 10,5 | 20 | 300 | 3000 | 95 | 0.310 | 1\20 | 1 |

ΑΝΤΑΛΛΑΚΤΙΚΟ DRIVER / SPARE DRIVER: **145-68096** (3 YEARS GUARANTEE)

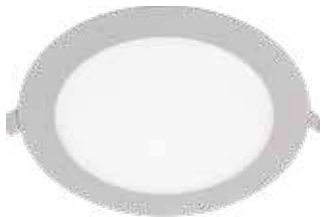

CUPOWER
LED Driver

Σατινέ/ Satin

Ø225 20W



LED Type SMD2835 • Chip Brand Epistar • Volt 85-265V 50/60Hz • Output Volt 55-65V DC
Start Time 0,5 sec • PF >0,50 • Operating Temperature -10°C / +60°C
Installation Height 2-3m • Connection Καλώδιο / Wire
Production Material Αλουμίνιο & Πλαστικό / Aluminium & Plastic

| Code | Barcode | Dimension Ø (mm) † | Watt | Amperage mA | Kelvin | Lumen/Watt | Weight (kg) | Packing | MOQ |
|-----------|---------------|--------------------|------|-------------|--------|------------|-------------|---------|-----|
| 145-68410 | 5207227033599 | 225 x 10,5 | 20 | 300 | 6500 | 105 | 0.310 | 1\20 | 1 |
| 145-68411 | 5207227033612 | 225 x 10,5 | 20 | 300 | 4000 | 103 | 0.310 | 1\20 | 1 |
| 145-68412 | 5207227033636 | 225 x 10,5 | 20 | 300 | 3000 | 95 | 0.310 | 1\20 | 1 |

ΑΝΤΑΛΛΑΚΤΙΚΟ DRIVER / SPARE DRIVER: **145-68096** (3 YEARS GUARANTEE)



LIFUD
LED Driver

Λευκό / White

Ø225 20W



LED Type SMD2835 • Chip Brand Epistar • Volt 85-265V 50/60Hz • Output Volt 55-65V DC
Start Time 0,5 sec • PF >0,50 • Operating Temperature -10°C / +60°C
Installation Height 2-3m • Connection Καλώδιο / Wire
Production Material Αλουμίνιο & Πλαστικό / Aluminium & Plastic

| Code | Barcode | Dimension Ø (mm) † | Watt | Amperage mA | Kelvin | Total Lumen | Weight (kg) | Packing | MOQ |
|-----------|---------------|--------------------|------|-------------|--------|-------------|-------------|---------|-----|
| 145-68450 | 5207227282669 | 225 x 20 | 20 | 300 | 6500 | 2000 | 0.300 | 1\20 | 1 |
| 145-68452 | 5207227282652 | 225 x 20 | 20 | 300 | 5000 | 2000 | 0.300 | 1\20 | 1 |
| 145-68451 | 5207227282645 | 225 x 20 | 20 | 300 | 4000 | 2000 | 0.300 | 1\20 | 1 |
| 145-68453 | 5207227498626 | 225 x 20 | 20 | 300 | 3000 | 2000 | 0.300 | 1\20 | 1 |



CUPOWER
LED Driver

○ Λευκό / White

Ø50-115mm



LED Type SMD2835 • Chip Brand Epistar • Volt 85-265V 50/60Hz • Output Volt 24-42V DC
Start Time 0,5 sec • PF >0,50 • Operating Temperature -10°C / +60°C
Installation Height 2-3m • Connection Καλώδιο / Wire
Production Material Αλουμίνιο & Πλαστικό / Aluminium & Plastic

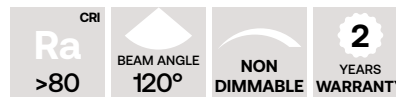

| Code | Barcode | Dimension Ø (mm) † | Watt | Amperage mA | Kelvin | Lumen/Watt | Weight (kg) | Packing | MOQ |
|-----------|---------------|--------------------|------|-------------|--------|------------|-------------|---------|-----|
| 145-68423 | 5207227071911 | 120 x 10,5 | 8 | 300 | 6500 | 105 | 0.210 | 1\40 | 1 |
| 145-68424 | 5207227071928 | 120 x 10,5 | 8 | 300 | 4000 | 103 | 0.210 | 1\40 | 1 |
| 145-68425 | 5207227071935 | 120 x 10,5 | 8 | 300 | 3000 | 95 | 0.210 | 1\40 | 1 |



CUPOWER
LED Driver

○ Λευκό / White

Ø50-210mm



LED Type SMD2835 • Chip Brand Epistar • Volt 85-265V 50/60Hz • Output Volt 60-75V DC
Start Time 0,5 sec • PF >0,50 • Operating Temperature -10°C / +60°C
Installation Height 2-3m • Connection Καλώδιο / Wire
Production Material Αλουμίνιο & Πλαστικό / Aluminium & Plastic

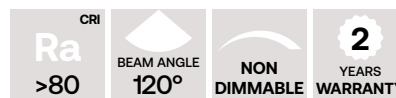

| Code | Barcode | Dimension Ø (mm) † | Watt | Amperage mA | Kelvin | Lumen/Watt | Weight (kg) | Packing | MOQ |
|-----------|---------------|--------------------|------|-------------|--------|------------|-------------|---------|-----|
| 145-68420 | 5207227033650 | 225 x 12 | 20 | 300 | 6500 | 105 | 0.310 | 1\20 | 1 |
| 145-68421 | 5207227033674 | 225 x 12 | 20 | 300 | 4000 | 103 | 0.310 | 1\20 | 1 |
| 145-68422 | 5207227033698 | 225 x 12 | 20 | 300 | 3000 | 95 | 0.310 | 1\20 | 1 |

ΑΝΤΑΛΛΑΚΤΙΚΟ DRIVER / SPARE DRIVER: 145-68093

Χωνευτά LED Slim Panels με Ρυθμιζόμενη Εγκοπή Τοποθέτησης

Ανακαλύψτε τα νέα χωνευτά LED slim panels με ρυθμιζόμενη εγκοπή τοποθέτησης, ιδανικά για κάθε χώρο. Αυτά τα πάνελ προσφέρουν εξαιρετική φωτεινότητα και ενεργειακή απόδοση, ενώ η λεπτή τους σχεδίαση εξασφαλίζει διακριτική ενσωμάτωση σε κάθε οροφή. Η ρυθμιζόμενη εγκοπή τοποθέτησης επιτρέπει εύκολη και ευέλικτη εγκατάσταση, προσαρμοζόμενη στις ανάγκες του χώρου σας. Ιδανικά για οικιακή και επαγγελματική χρήση, τα LED slim panels μας εγγυώνται μακροχρόνια απόδοση και οικονομία στην κατανάλωση ενέργειας.

Recessed LED Slim Panels with Adjustable Mounting Cutout

Discover the new recessed LED slim panels with an adjustable mounting cutout, perfect for any space. These panels offer excellent brightness and energy efficiency, while their slim design ensures discreet integration into any ceiling. The adjustable mounting cutout allows for easy and flexible installation, adapting to your space's needs. Ideal for both residential and commercial use, our LED slim panels guarantee long-lasting performance and energy savings.



CUPOWER
LED Driver

○ Λευκό / White

Ø225 25W, 30W, 40W



LED Type SMD2835 • Chip Brand Epistar • Volt 85-265V 50/60Hz • Output Volt 65-75V DC
 Start Time 2 sec • PF >0,90 • Operating Temperature -20°C / +40°C
 Installation Height 3-4m • Connection Καλώδιο / Wire
 Production Material Αλουμίνιο & Πλαστικό / Aluminium & Plastic

| | | | |
|-------------------------|---------------------------|---------------------|-------------------------|
| CRI Ra >80 | BEAM ANGLE 120° | NON DIMMABLE | 3 YEARS WARRANTY |
|-------------------------|---------------------------|---------------------|-------------------------|

| Code | Barcode | Dimension Ø (mm) † | Watt | Amperage mA | Kelvin | Lumen/Watt | Weight (kg) | Packing | MOQ |
|-----------|---------------|--------------------|------|-------------|--------|------------|-------------|---------|-----|
| 145-68430 | 5207227120961 | 225 x 45 | 25 | 630 | 6500 | 105 | 0.480 | 1\20 | 1 |
| 145-68431 | 5207227120985 | 225 x 45 | 25 | 630 | 4000 | 103 | 0.480 | 1\20 | 1 |
| 145-68432 | 5207227120992 | 225 x 45 | 25 | 630 | 3000 | 95 | 0.480 | 1\20 | 1 |

ΑΝΤΑΛΛΑΚΤΙΚΟ DRIVER / SPARE DRIVER: **145-68490**

Installation Height 4-5m

| Code | Barcode | Dimension Ø (mm) † | Watt | Amperage mA | Kelvin | Lumen/Watt | Weight (kg) | Packing | MOQ |
|-----------|---------------|--------------------|------|-------------|--------|------------|-------------|---------|-----|
| 145-68433 | 5207227121005 | 225 x 45 | 30 | 760 | 6500 | 105 | 0.480 | 1\20 | 1 |
| 145-68434 | 5207227121012 | 225 x 45 | 30 | 760 | 4000 | 103 | 0.480 | 1\20 | 1 |
| 145-68435 | 5207227121029 | 225 x 45 | 30 | 760 | 3000 | 95 | 0.480 | 1\20 | 1 |

ΑΝΤΑΛΛΑΚΤΙΚΟ DRIVER / SPARE DRIVER: **145-68491**

Installation Height 5-7m

| Code | Barcode | Dimension Ø (mm) † | Watt | Amperage mA | Kelvin | Lumen/Watt | Weight (kg) | Packing | MOQ |
|-----------|---------------|--------------------|------|-------------|--------|------------|-------------|---------|-----|
| 145-68436 | 5207227121036 | 225 x 45 | 40 | 1000 | 6500 | 105 | 0.480 | 1\20 | 1 |
| 145-68437 | 5207227121043 | 225 x 45 | 40 | 1000 | 4000 | 103 | 0.480 | 1\20 | 1 |
| 145-68438 | 5207227121050 | 225 x 45 | 40 | 1000 | 3000 | 95 | 0.480 | 1\20 | 1 |

ΑΝΤΑΛΛΑΚΤΙΚΟ DRIVER / SPARE DRIVER: **145-68492**





ΣΥΝΔΥΑΖΕΤΑΙ ΜΕ / COMBINED WITH:
Όλα τα Panel Χωνευτά ή Εξωτερικά από 7W έως 24W
All Panel Recessed or Surface from 7W to 24W

LIFUD
LED Driver

Λευκό / White

7-15W, 15-24W Dimmer Ohm

20.000h

ON OFF
15.000

IP20

CLASS II



Volt 100-240V 50/60Hz • Output Volt 21-52V DC
PF >0,50 • Operating Temperature -20°C / +40°C
Connection Καλώδιο / Wire
Production Material Πλαστικό/ Plastic



| Code | Barcode | Dimension (mm) | | | Watt | Amperage mA | Weight (kg) | Packing | MOQ |
|-----------|---------------|----------------|----|----|-------|-------------|-------------|---------|-----|
| | | ↕ | ↔ | ↕ | | | | | |
| 145-68090 | 5207227191992 | 80 | 35 | 20 | 7-15 | 350 | 0.210 | 1\100 | 1 |
| 145-68091 | 5207227192005 | 80 | 35 | 20 | 15-24 | 600 | 0.210 | 1\100 | 1 |



ΣΥΝΔΥΑΖΕΤΑΙ ΜΕ / COMBINED WITH:
Όλα τα Panel Χωνευτά ή Εξωτερικά από 7W έως 24W
All Panel Recessed or Surface from 7W to 24W

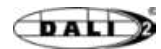

CUPOWER
LED Driver

Λευκό / White

7-12W, 15-24W Dimming Dali

100.000h

ON OFF
100.000

IP20

CLASS II



Volt 198-264V 50/60Hz • Output Volt 6-52V DC
PF >0,90 • Operating Temperature -20°C / +50°C
Connection Καλώδιο / Wire
Production Material Πλαστικό/ Plastic



| Code | Barcode | Dimension (mm) | | | Watt | Amperage mA | Weight (kg) | Packing | MOQ |
|-----------|---------------|----------------|----|----|-------|-------------|-------------|---------|-----|
| | | ↕ | ↔ | ↕ | | | | | |
| 145-68080 | 5207227279324 | 97 | 43 | 30 | 7-12 | 350 | 0.210 | 1\100 | 1 |
| 145-68081 | 5207227279348 | 97 | 43 | 30 | 15-24 | 600 | 0.210 | 1\100 | 1 |



Στεφάνι υποστήριξης Ø240 για Ø225 / Frame adaptor Ø240 for Ø225

Production Material Αλουμίνιο/ Aluminium

| Code | Barcode | Dimension Ø (mm) ↕ | Weight (kg) | Packing | MOQ |
|-----------|---------------|--------------------|-------------|---------|-----|
| 145-68099 | 5207227072178 | Ø240 | 0.250 | 1 | 1 |



25W, 30W, 40W

Λευκό / White



Volt 85-265V 50/60Hz · Output Volt 24-42V DC
 Start Time 0,5 sec · PF >0,50 · Operating Temperature -20°C / +40°C
 Connection Καλώδιο / Wire
 Production Material Πλαστικό/ Plastic



| Code | Barcode | Dimension (mm) | | | Watt | Weight (kg) | Packing | MOQ |
|-----------|---------------|----------------|----|----|------|-------------|----------|-----|
| | | ↗ | ↔ | ↘ | | | | |
| 145-68490 | 5207227268809 | 90 | 35 | 20 | 25 | 0.200 | 1/10/100 | 1 |
| 145-68491 | 5207227207471 | 95 | 35 | 20 | 30 | 0.250 | 1/10/100 | 1 |
| 145-68492 | 5207227268816 | 95 | 35 | 20 | 40 | 0.300 | 1/10/100 | 1 |



20W 85-265V

Λευκό / White



Volt 85-265V 50/60Hz · Max Output 38-64V DC · Start Time 0,5 sec · PF >0,50
 Operating Temperature -10°C / +60°C
 Connection Καλώδιο / Wire · Production Material Πλαστικό/ Plastic



| Code | Barcode | Watt | Weight (kg) | Packing | MOQ |
|-----------|---------------|------|-------------|---------|-----|
| 145-68097 | 5207227039409 | 20 | 0.070 | 1\200 | 1 |



20W, 24W, 30W 85-265V

Ο κωδικός / Code 145-68092
 συνδυάζεται με / is combined with
 145-68201 145-68202



Λευκό / White

Ο κωδικός / Code 145-68093
 συνδυάζεται με / is combined with
 145-68420 145-68421 145-68422



Volt 85-265V 50/60Hz
 Start Time 0,5 sec · PF >0,50 · Operating Temperature -10°C / +60°C
 Connection Καλώδιο / Wire
 Production Material Πλαστικό/ Plastic



| Code | Barcode | Series | Watt | Weight (kg) | Packing | MOQ |
|-----------|---------------|--------|------|-------------|----------|-----|
| 145-68096 | 5207227035494 | PRO | 20 | 0.070 | 1\200 | 1 |
| 145-68093 | 5207227279270 | PRO | 20 | 0.210 | 1\10\100 | 1 |
| 145-68098 | 5207227110719 | PRO | 24 | 0.070 | 1\10\100 | 1 |
| 145-68092 | 5207227279294 | PLUS | 30 | 0.210 | 1\10\100 | 1 |



Τροφοδοτικό Μπαταρίας Universal Universal Battery Emergency Driver



Volt 220-240V 50/60Hz • Output Volt 24-80V DC • PF > 0,90 • Operating Temperature -25°C / +70°C

Battery Type 60-120min Lithium: 7,4V 2200mAh

Connection Καλώδιο / Wire • Production Material Πλαστικό / Plastic

| Code | Barcode | Dimension (mm) | | | Watt | Weight (kg) | Packing | MOQ |
|-----------|---------------|----------------|----|------|-------|-------------|---------|-----|
| | | ↕ | ↔ | ↕ | | | | |
| 145-56180 | 5207227058882 | 202 | 42 | 27,5 | 12-80 | 0.211 | 1\50 | 1 |

Τροφοδοτικό Μπαταρίας Εφεδρείας,

σχεδιασμένο να υποστηρίξει απαιτήσεις ισχύος από 12W έως 80W και να παρέχει 60-120 λεπτά εφεδρικής ισχύος. Αυτό το ευέλικτο τροφοδοτικό εξασφαλίζει αξιόπιστη απόδοση και είναι ιδανικό για χρήση με πάνελ LED. Ο συμπαγής σχεδιασμός του και η υψηλή απόδοση το καθιστούν απαραίτητο αξεσουάρ για οικιακή και επαγγελματική χρήση.

Backup Battery Power Supply

is designed to support power requirements from 12W to 80W and provide 60-120 minutes of backup power. This versatile power supply ensures reliable performance and is ideal for use with LED panels. Its compact design and high efficiency make it an essential accessory for both home and professional use.





Φωτιστικά LED
Εξωτερικά

LED Fixtures
Surface Mounted



CUPOWER
LED Driver

○ Λευκό / White

Ø120mm 6W



LED Type SMD2835 • Chip Brand Sanan • Volt 85-265V 50/60Hz
Start Time 0,5 sec • PF >0,90 • Operating Temperature -10°C / +60°C
Connection Καλώδιο / Wire
Production Material Αλουμίνιο & Πλαστικό / Aluminium & Plastic

| | | | | |
|----------------------------|------------------|--------------------|--------------|------------------|
| LUMEN / WATT lm/W 90 | CRI Ra >80 | BEAM ANGLE 120° | NON DIMMABLE | 2 YEARS WARRANTY |
|----------------------------|------------------|--------------------|--------------|------------------|

| Code | Barcode | Dimension Ø (mm) † | Watt | Amperage mA | Kelvin | Total Lumen | Weight (kg) | Installation Height | Packing | MOQ |
|-----------|---------------|--------------------|------|-------------|--------|-------------|-------------|---------------------|---------|-----|
| 145-68500 | 5207227069468 | 120 x 32 | 6 | 300 | 6500 | 540 | 0.100 | 2 - 3m | 1\40 | 1 |
| 145-68501 | 5207227069482 | 120 x 32 | 6 | 300 | 4000 | 540 | 0.100 | 2 - 3m | 1\40 | 1 |
| 145-68502 | 5207227069505 | 120 x 32 | 6 | 300 | 3000 | 540 | 0.100 | 2 - 3m | 1\40 | 1 |

Ø170mm 12W

| | Barcode | Dimension Ø (mm) † | Watt | Amperage mA | Kelvin | Total Lumen | Weight (kg) | Installation Height | Packing | MOQ |
|-----------|---------------|--------------------|------|-------------|--------|-------------|-------------|---------------------|---------|-----|
| 145-68506 | 5207227069529 | 170 x 32 | 12 | 300 | 6500 | 1080 | 0.200 | 2 - 3m | 1\20 | 1 |
| 145-68507 | 5207227069543 | 170 x 32 | 12 | 300 | 4000 | 1080 | 0.200 | 2 - 3m | 1\20 | 1 |
| 145-68508 | 5207227069567 | 170 x 32 | 12 | 300 | 3000 | 1080 | 0.200 | 2 - 3m | 1\20 | 1 |

Ø225mm 20W

| | Barcode | Dimension Ø (mm) † | Watt | Amperage mA | Kelvin | Total Lumen | Weight (kg) | Installation Height | Packing | MOQ |
|-----------|---------------|--------------------|------|-------------|--------|-------------|-------------|---------------------|---------|-----|
| 145-68510 | 5207227124105 | 225 x 32 | 20 | 300 | 6500 | 1800 | 0.300 | 2 - 3m | 1\20 | 1 |
| 145-68511 | 5207227124112 | 225 x 32 | 20 | 300 | 4000 | 1800 | 0.300 | 2 - 3m | 1\20 | 1 |
| 145-68512 | 5207227124136 | 225 x 32 | 20 | 300 | 3000 | 1800 | 0.300 | 2 - 3m | 1\20 | 1 |

ΑΝΤΑΛΛΑΚΤΙΚΟ DRIVER / SPARE DRIVER: 145-68097 (2 YEARS GUARANTEE) / 145-68096 (3 YEARS GUARANTEE)

Ø225mm 24W

| | Barcode | Dimension Ø (mm) † | Watt | Amperage mA | Kelvin | Total Lumen | Weight (kg) | Installation Height | Packing | MOQ |
|-----------|---------------|--------------------|------|-------------|--------|-------------|-------------|---------------------|---------|-----|
| 145-68513 | 5207227117640 | 225 x 32 | 24 | 400 | 6500 | 2160 | 0.350 | 3 - 5m | 1\20 | 1 |
| 145-68514 | 5207227117657 | 225 x 32 | 24 | 400 | 4000 | 2160 | 0.350 | 3 - 5m | 1\20 | 1 |
| 145-68515 | 5207227117664 | 225 x 32 | 24 | 400 | 3000 | 2160 | 0.350 | 3 - 5m | 1\20 | 1 |

ΑΝΤΑΛΛΑΚΤΙΚΟ DRIVER / SPARE DRIVER: 145-68098

Ø300mm 30W

| Code | Barcode | Dimension Ø (mm) † | Watt | Amperage mA | Kelvin | Total Lumen | Weight (kg) | Installation Height | Packing | MOQ |
|-----------|---------------|--------------------|------|-------------|--------|-------------|-------------|---------------------|---------|-----|
| 145-68516 | 5207227117671 | 300 x 32 | 30 | 300 | 6500 | 2700 | 0.450 | 3 - 5m | 1\10 | 1 |
| 145-68517 | 5207227117688 | 300 x 32 | 30 | 300 | 4000 | 2700 | 0.450 | 3 - 5m | 1\10 | 1 |
| 145-68518 | 5207227117695 | 300 x 32 | 30 | 300 | 3000 | 2700 | 0.450 | 3 - 5m | 1\10 | 1 |

ΑΝΤΑΛΛΑΚΤΙΚΟ DRIVER / SPARE DRIVER: 145-68092

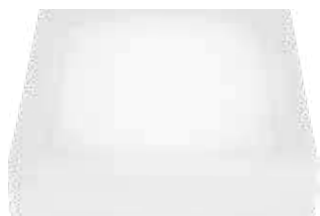

120X120 6W

Λευκό / White

CUPOWER
LED Driver



LED Type SMD2835 • Chip Brand Sanan • Volt 85-265V 50/60Hz
Start Time 0,5 sec • PF >0,90 • Operating Temperature -10°C / +60°C
Connection Καλώδιο / Wire
Production Material Αλουμίνιο & Πλαστικό / Aluminium & Plastic

| | | | | |
|----------------------------|------------------|--------------------|--------------|------------------|
| LUMEN / WATT lm/W 90 | CRI Ra >80 | BEAM ANGLE 120° | NON DIMMABLE | 2 YEARS WARRANTY |
|----------------------------|------------------|--------------------|--------------|------------------|

| Code | Barcode | Dimension (mm) | | | Amperage | | Kelvin | Total Lumen | Weight (kg) | Installation Height | Packing | MOQ |
|-----------|---------------|----------------|-----|----|----------|-----|--------|-------------|-------------|---------------------|---------|-----|
| | | ↗ | ↔ | ↘ | Watt | mA | | | | | | |
| 145-68520 | 5207227069581 | 120 | 120 | 32 | 6 | 300 | 6500 | 540 | 0.150 | 2 - 3m | 1\20 | 1 |
| 145-68521 | 5207227069604 | 120 | 120 | 32 | 6 | 300 | 4000 | 540 | 0.150 | 2 - 3m | 1\20 | 1 |
| 145-68522 | 5207227069628 | 120 | 120 | 32 | 6 | 300 | 3000 | 540 | 0.150 | 2 - 3m | 1\20 | 1 |

170X170 12W

| Code | Barcode | Dimension (mm) | | | Amperage | | Kelvin | Total Lumen | Weight (kg) | Installation Height | Packing | MOQ |
|-----------|---------------|----------------|-----|----|----------|-----|--------|-------------|-------------|---------------------|---------|-----|
| | | ↗ | ↔ | ↘ | Watt | mA | | | | | | |
| 145-68526 | 5207227069642 | 170 | 170 | 32 | 12 | 300 | 6500 | 1080 | 0.220 | 2 - 3m | 1\20 | 1 |
| 145-68527 | 5207227069666 | 170 | 170 | 32 | 12 | 300 | 4000 | 1080 | 0.220 | 2 - 3m | 1\20 | 1 |
| 145-68528 | 5207227069680 | 170 | 170 | 32 | 12 | 300 | 3000 | 1080 | 0.220 | 2 - 3m | 1\20 | 1 |

225X225mm 20W

| Code | Barcode | Dimension (mm) | | | Amperage | | Kelvin | Total Lumen | Weight (kg) | Installation Height | Packing | MOQ |
|-----------|---------------|----------------|-----|----|----------|-----|--------|-------------|-------------|---------------------|---------|-----|
| | | ↗ | ↔ | ↘ | Watt | mA | | | | | | |
| 145-68530 | 5207227124143 | 225 | 225 | 32 | 20 | 300 | 6500 | 1800 | 0.320 | 2 - 3m | 1\20 | 1 |
| 145-68531 | 5207227124150 | 225 | 225 | 32 | 20 | 300 | 4000 | 1800 | 0.320 | 2 - 3m | 1\20 | 1 |
| 145-68532 | 5207227124174 | 225 | 225 | 32 | 20 | 300 | 3000 | 1800 | 0.320 | 2 - 3m | 1\20 | 1 |

ΑΝΤΑΛΛΑΚΤΙΚΟ DRIVER / SPARE DRIVER: **145-68097** (2 YEARS GUARANTEE) / **145-68096** (3 YEARS GUARANTEE)

225X225mm 24W

| Code | Barcode | Dimension (mm) | | | Amperage | | Kelvin | Total Lumen | Weight (kg) | Installation Height | Packing | MOQ |
|-----------|---------------|----------------|-----|----|----------|-----|--------|-------------|-------------|---------------------|---------|-----|
| | | ↗ | ↔ | ↘ | Watt | mA | | | | | | |
| 145-68533 | 5207227124181 | 225 | 225 | 32 | 24 | 400 | 6500 | 2160 | 0.350 | 3 - 5m | 1\20 | 1 |
| 145-68534 | 5207227124198 | 225 | 225 | 32 | 24 | 400 | 4000 | 2160 | 0.350 | 3 - 5m | 1\20 | 1 |
| 145-68535 | 5207227124204 | 225 | 225 | 32 | 24 | 400 | 3000 | 2160 | 0.350 | 3 - 5m | 1\20 | 1 |

ΑΝΤΑΛΛΑΚΤΙΚΟ DRIVER / SPARE DRIVER: **145-68098**

300X300mm 30W

| Code | Barcode | Dimension (mm) | | | Amperage | | Kelvin | Total Lumen | Weight (kg) | Installation Height | Packing | MOQ |
|-----------|---------------|----------------|-----|----|----------|-----|--------|-------------|-------------|---------------------|---------|-----|
| | | ↗ | ↔ | ↘ | Watt | mA | | | | | | |
| 145-68536 | 5207227117619 | 300 | 300 | 32 | 30 | 300 | 6500 | 2700 | 0.450 | 3 - 5m | 1\10 | 1 |
| 145-68537 | 5207227117626 | 300 | 300 | 32 | 30 | 300 | 4000 | 2700 | 0.450 | 3 - 5m | 1\10 | 1 |
| 145-68538 | 5207227117633 | 300 | 300 | 32 | 30 | 300 | 3000 | 2700 | 0.450 | 3 - 5m | 1\10 | 1 |

ΑΝΤΑΛΛΑΚΤΙΚΟ DRIVER / SPARE DRIVER: **145-68092**



3CCT

3000K 4000K 6500K

Ø40-Ø60



LED Type SMD2835 · Chip Brand Epistar · Volt 220-240V 50/60Hz · Output Volt 65-75V DC
 Start Time 0,5 sec · PF >0,50 · Operating Temperature -10°C / +40°C
 Installation Height 3-5m · Connection Καλώδιο / Wire
 Production Material Πλαστικό / Plastic

| | | | | |
|----------------------------|------------------|--------------------|--------------|------------------|
| LUMEN / WATT lm/W 60 | CRI Ra >80 | BEAM ANGLE 120° | NON DIMMABLE | 2 YEARS WARRANTY |
|----------------------------|------------------|--------------------|--------------|------------------|

| Code | Barcode | Dimension Ø (mm) † | Color | Watt | Amperage mA | Kelvin | Total Lumen | Weight (kg) | Packing | MOQ |
|-----------|---------------|-----------------------|-------|------|----------------|--------|-------------|----------------|---------|-----|
| 145-68569 | 5207227466649 | 300 x 24 | WHITE | 24 | 300 | 3CCT | 1440 | 0.500 | 1\10 | 1 |
| 145-68570 | 5207227466663 | 300 x 24 | BLACK | 24 | 300 | 3CCT | 1440 | 0.500 | 1\10 | 1 |
| 145-68571 | 5207227270994 | 400 x 24 | WHITE | 36 | 280 | 3CCT | 2160 | 0.680 | 1\10 | 1 |
| 145-68572 | 5207227271014 | 400 x 24 | BLACK | 36 | 280 | 3CCT | 2160 | 0.680 | 1\10 | 1 |
| 145-68573 | 5207227271038 | 500 x 24 | WHITE | 42 | 300 | 3CCT | 2520 | 1.700 | 1\5 | 1 |
| 145-68575 | 5207227271052 | 500 x 24 | BLACK | 42 | 300 | 3CCT | 2520 | 1.700 | 1\5 | 1 |
| 145-68576 | 5207227271076 | 600 x 24 | WHITE | 48 | 360 | 3CCT | 2880 | 2.600 | 1\5 | 1 |
| 145-68577 | 5207227271090 | 600 x 24 | BLACK | 48 | 360 | 3CCT | 2880 | 2.600 | 1\5 | 1 |



Ροζέτα οροφής MG - Lampholder MG



Connection Καλώδιο / Wire
 Production Material Μεταλλικό / Metal



| Code | Barcode | Dimension Ø (mm) † | Color | Weight (kg) | Packing | MOQ |
|-----------|---------------|-----------------------|---------------|----------------|---------|-----|
| 145-68578 | 5207227271113 | 150 x 40 | ΛΕΥΚΟ / WHITE | 0.200 | 1\40 | 1 |
| 145-68579 | 5207227282638 | 150 x 40 | ΜΑΥΡΟ / BLACK | 0.200 | 1\40 | 1 |



Bat Cap 2.2Ah
 Bat Charg 24h
 Bat Type Lithium 18650
 Bat Auto 5h

*Οι κωδικοί με σένσορα μπορούν να λειτουργήσουν ως master-slave

Αισθητήρας Μικροκυμάτων / Microwave Sensor
 Εξωτερικής Τοποθέτησης / Surface Installation

○ Λευκό / White

Πλαφονιέρα LED LED Ceiling Light



LED Type COB • Chip Brand Epistar • Volt 220-240V 50/60Hz • Output Volt 33-40V DC
 Start Time 0,5 sec • PF >0,90 • Operating Temperature 5°C / +40°C
 Installation Height 3-4m • Connection Κλέμμα/Terminal Block
 Production Material Πλαστικό UV/Plastic UV

| | | | | |
|----------------------------|------------------|-------------------------|--------------|------------------|
| LUMEN / WATT lm/W 81 | CRI Ra >80 | BEAM ANGLE 180°/360° | NON DIMMABLE | 3 YEARS WARRANTY |
|----------------------------|------------------|-------------------------|--------------|------------------|

Bat Cap 2.2Ah • Bat Charg 24h • Bat Type Lithium 18650 • Bat Auto 5h
 Αισθητήρας Μικροκυμάτων / Microwave Sensor • Εξωτερικής Τοποθέτησης / Surface Installation

EMERGENCY

| Code | Barcode | Dimension Ø (mm) ↓ | Watt | Amperage mA | Kelvin | Total Lumen | Weight (kg) | Packing | MOQ |
|-----------|---------------|--------------------|------|-------------|--------|-------------|-------------|---------|-----|
| 145-55302 | 5206139080905 | 300 x 87 | 16 | 300 | 4000 | 1246 | 0.495 | 1\5 | 1 |

Operating Temperature -20°C / +40°C

Επιτοίχια: max 15m • Οροφής: 2m - 8m / Wall: max 15m • Ceiling: 2m - 8m

Αισθητήρας Μικροκυμάτων / Microwave Sensor • Expands 10 pcs • Χρόνος Καθυστερήσης: 3 sec έως 12 min / Delay Time: 3 sec to 12 min

Δυνατότητα Επέκτασης / Expansion Ability

MASTER DEFLECTOR



| Code | Barcode | Dimension Ø (mm) ↓ | Watt | Amperage mA | Kelvin | Total Lumen | Weight (kg) | Packing | MOQ |
|-----------|---------------|--------------------|------|-------------|--------|-------------|-------------|---------|-----|
| 145-55301 | 5206139080899 | 300 x 87 | 16 | 300 | 4000 | 1296 | 1.031 | 1\5 | 1 |

Operating Temperature -20°C / +40°C

Επιτοίχια: max 15m • Οροφής: 2m - 8m / Wall: max 15m • Ceiling: 2m - 8m

Δυνατότητα Επέκτασης / Expansion Ability

SLAVE



| Code | Barcode | Dimension Ø (mm) ↓ | Watt | Amperage mA | Kelvin | Total Lumen | Weight (kg) | Packing | MOQ |
|-----------|---------------|--------------------|------|-------------|--------|-------------|-------------|---------|-----|
| 145-55307 | 5207227116308 | 300 x 87 | 16 | 300 | 4000 | 1296 | 0.958 | 1\5 | 1 |





3CCT

2700K 4000K 6500K



10W/16W 3CCT D110xH65mm



LED Type SMD2835 • Chip Brand AMTC • Volt 220-240V 50/60Hz
 Start Time 0,5 sec • PF >0,90 • Operating Temperature -10°C / +60°C
 Installation Height 2-3m • Connection Κλέμμα/Terminal Block
 Production Material Αλουμίνιο & Πλαστικό / Aluminium & Plastic

CRI **Ra >80** BEAM ANGLE **120°** NON DIMMABLE **3 YEARS WARRANTY**

| Code | Barcode | Dimension Ø (mm) † | Color | Watt | Amperage mA | Kelvin | Lumen/Watt | Weight (kg) | Packing | MOQ |
|-----------|---------------|--------------------|-------|------|-------------|--------|------------|-------------|---------|-----|
| 147-52643 | 5207227277900 | 110 x 65 | White | 10 | 250 | 3CCT | 89 | 1.32 | 1\20 | 1 |
| 147-52644 | 5207227277917 | 110 x 65 | Black | 10 | 250 | 3CCT | 86 | 1.32 | 1\20 | 1 |
| 147-52645 | 5207227277924 | 140 x 65 | White | 16 | 400 | 3CCT | 95 | 0.47 | 1\20 | 1 |
| 147-52646 | 5207227277931 | 140 x 65 | Black | 16 | 400 | 3CCT | 91 | 0.47 | 1\20 | 1 |



3CCT

2700K 4000K 6500K



10W/16W 3CCT D100xH86mm



LED Type SMD2835 • Chip Brand AMTC • Volt 220-240V 50/60Hz
 Start Time 0,5 sec • PF >0,90 • Operating Temperature -10°C / +60°C
 Installation Height 2-3m • Connection Κλέμμα/Terminal Block
 Production Material Αλουμίνιο & Πλαστικό / Aluminium & Plastic

CRI **Ra >80** BEAM ANGLE **120°** NON DIMMABLE **3 YEARS WARRANTY**

| Code | Barcode | Dimension Ø (mm) † | Color | Watt | Amperage mA | Kelvin | Lumen/Watt | Weight (kg) | Packing | MOQ |
|-----------|---------------|--------------------|-------|------|-------------|--------|------------|-------------|---------|-----|
| 147-52647 | 5207227277948 | 100 x 86 | White | 10 | 250 | 3CCT | 65 | 0.270 | 1\20 | 1 |
| 147-52648 | 5207227277955 | 100 x 86 | Black | 10 | 250 | 3CCT | 62 | 0.270 | 1\20 | 1 |
| 147-52649 | 5207227277962 | 120 x 86 | White | 10 | 400 | 3CCT | 62 | 0.360 | 1\20 | 1 |
| 147-52650 | 5207227277979 | 120 x 86 | Black | 10 | 400 | 3CCT | 58 | 0.360 | 1\20 | 1 |





3CCT

2700K 4000K 6500K



16W/24W 3CCT D110xH88mm



LED Type SMD2835 • Chip Brand AMTC • Volt 220-240V 50/60Hz
 Start Time 0,5 sec • PF >0,90 • Operating Temperature -10°C / +60°C
 Installation Height 2-3m • Connection Κλέμμα/Terminal Block
 Production Material Αλουμίνιο & Πλαστικό / Aluminium & Plastic

CRI **Ra >80** BEAM ANGLE **120°** NON DIMMABLE **3 YEARS WARRANTY**

| Code | Barcode | Dimension Ø (mm) † | Color | Watt | Amperage mA | Kelvin | Lumen/Watt | Weight (kg) | Packing | MOQ |
|-----------|---------------|--------------------|-------|------|-------------|--------|------------|-------------|---------|-----|
| 147-52651 | 5207227277986 | 110 x 88 | White | 16 | 400 | 3CCT | 50 | 0.34 | 1\20 | 1 |
| 147-52652 | 5207227277993 | 110 x 88 | Black | 16 | 400 | 3CCT | 48 | 0.34 | 1\20 | 1 |
| 147-52653 | 5207227278006 | 140 x 88 | White | 24 | 600 | 3CCT | 75 | 0.49 | 1\20 | 1 |
| 147-52654 | 5207227278013 | 140 x 88 | Black | 24 | 600 | 3CCT | 72 | 0.49 | 1\20 | 1 |

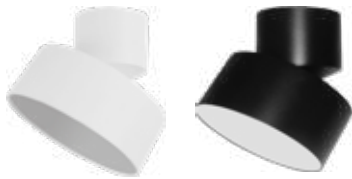

3CCT

2700K 4000K 6500K



10W/16W 3CCT D110xH125mm



LED Type SMD2835 • Chip Brand AMTC • Volt 220-240V 50/60Hz
 Start Time 0,5 sec • PF >0,90 • Operating Temperature -10°C / +60°C
 Installation Height 2-3m • Connection Κλέμμα/Terminal Block
 Production Material Αλουμίνιο & Πλαστικό / Aluminium & Plastic

CRI **Ra >80** BEAM ANGLE **120°** NON DIMMABLE **3 YEARS WARRANTY**

| Code | Barcode | Dimension Ø (mm) † | Color | Watt | Amperage mA | Kelvin | Lumen/Watt | Weight (kg) | Packing | MOQ |
|-----------|---------------|--------------------|-------|------|-------------|--------|------------|-------------|---------|-----|
| 147-52655 | 5207227278020 | 110 x 125 | White | 10 | 250 | 3CCT | 68 | 0.48 | 1\20 | 1 |
| 147-52656 | 5207227278037 | 110 x 125 | Black | 10 | 250 | 3CCT | 65 | 0.48 | 1\20 | 1 |
| 147-52657 | 5207227278044 | 140 x 125 | White | 16 | 400 | 3CCT | 87 | 0.57 | 1\20 | 1 |
| 147-52658 | 5207227278051 | 140 x 125 | Black | 16 | 400 | 3CCT | 84 | 0.57 | 1\20 | 1 |



Cutting Dimensions 150mm

3CCT

2700K 4000K 6500K



2x7W 3CCT 75x150x79mm



LED Type COB1304 • Chip Brand Tyanshint • Volt 220-240V 50/60Hz
 Start Time 0,5 sec • PF >0,90 • Operating Temperature -10°C / +60°C
 Installation Height 2-3m • Connection Κλέμμα/Terminal Block
 Production Material Αλουμίνιο & Πλαστικό / Aluminium & Plastic

CRI **Ra >80** BEAM ANGLE **120°** NON DIMMABLE **3 YEARS WARRANTY**

| Code | Barcode | Dimension Ø (mm) † | Color | Watt | Amperage mA | Kelvin | Lumen/Watt | Weight (kg) | Packing | MOQ |
|-----------|---------------|--------------------|-------|------|-------------|--------|------------|-------------|---------|-----|
| 147-52659 | 5207227278068 | 75 x 79 | White | 2x7 | 300 | 3CCT | 62 | 0.52 | 1\20 | 1 |
| 147-52660 | 5207227278075 | 75 x 79 | Black | 2x7 | 300 | 3CCT | 60 | 0.52 | 1\20 | 1 |



LIFUD
LED Driver

○ Λευκό / White

Ø141X141mm 20W / Ø170X160mm 30W



LED Type COB · Chip Brand Bridgelux · Volt 220-240V 50/60Hz · Output Volt 33-40V DC
Start Time 0,5 sec · PF >0,50 · Operating Temperature -10°C / +60°C
Installation Height 2-3m · Connection Καλώδιο / Wire
Production Material Αλουμίνιο & Πλαστικό / Aluminium & Plastic

CRI **Ra >80** BEAM ANGLE **36°** NON DIMMABLE **5 YEARS WARRANTY**

| Code | Barcode | Dimension (mm) Ø (mm) ↓ | Watt | Amperage mA | Kelvin | Lumen/Watt | Weight (kg) | Packing | MOQ |
|-----------|---------------|----------------------------|------|----------------|--------|------------|----------------|---------|-----|
| 145-65800 | 5207227282898 | 141 x 141 x 141 | 20 | 500 | 4000 | 100 | 1.30 | 1\8 | 1 |
| 145-65801 | 5207227282911 | 141 x 141 x 141 | 20 | 500 | 3000 | 100 | 1.30 | 1\8 | 1 |
| 145-65802 | 5207227282928 | 170 x 170 x 160 | 30 | 650 | 4000 | 100 | 1.50 | 1\8 | 1 |
| 145-65803 | 5207227282904 | 170 x 170 x 160 | 30 | 650 | 3000 | 100 | 1.50 | 1\8 | 1 |



LIFUD
LED Driver

○ Λευκό / White

130X130X135mm 30W



LED Type COB · Chip Brand Bridgelux · Volt 220-240V 50/60Hz · Output Volt 33-40V DC
Start Time 0,5 sec · PF >0,90 · Operating Temperature -10°C / +60°C
Installation Height 2-3m · Connection Καλώδιο / Wire
Production Material Αλουμίνιο & Πλαστικό / Aluminium & Plastic

CRI **Ra >80** BEAM ANGLE **36°** NON DIMMABLE **5 YEARS WARRANTY**

| Code | Barcode | Dimension (mm) ↔ ↔ ↓ | Watt | Amperage mA | Kelvin | Lumen/Watt | Weight (kg) | Packing | MOQ |
|-----------|---------------|-------------------------|------|----------------|--------|------------|----------------|---------|-----|
| 145-65806 | 5207227282874 | 130 x 130 x 135 | 30 | 650 | 4000 | 100 | 1.40 | 1\8 | 1 |
| 145-65807 | 5207227282881 | 130 x 130 x 135 | 30 | 650 | 3000 | 100 | 1.40 | 1\8 | 1 |





ΣΠΟΤ ΧΩΝΕΥΤΑ

Αλουμινίου / Σταθερά / Κινητά /
Στεγανά

Spot Recessed

Aluminum / Fixed / Movable /
Waterproof



Σταθερό - Fixed Ø90/86mm

Συμπεριλαμβάνεται ντουί
Lampholder included



Volt 12V-240V 50/60Hz
Operating Temperature -20°C / +40°C
Installation Height 2-5m • Connection Καλώδιο/Wire
Production Material Πολυκαρβονικό /Polycarbonate



| Code | Barcode | Dimension Ø (mm) † | Cutting Hole (mm) | Color | Watt | Weight (kg) | Packing | MOQ |
|-----------|---------------|--------------------|-------------------|-------|------------|-------------|---------|-----|
| 147-52700 | 5207227427206 | 90 x 35 | 55-80mm | White | MAX 7W LED | 0.03 | 1\100 | 1 |
| 147-52701 | 5207227427220 | 90 x 35 | 55-80mm | Black | MAX 7W LED | 0.03 | 1\100 | 1 |
| 147-52702 | 5207227427244 | 86 x 40 | 70-75mm | White | MAX 7W LED | 0.03 | 1\100 | 1 |
| 147-52703 | 5207227427268 | 86 x 40 | 70-75mm | Black | MAX 7W LED | 0.03 | 1\100 | 1 |



Κινητό - Movable Ø100/90mmx

Συμπεριλαμβάνεται ντουί
Lampholder included



Volt 12V-240V 50/60Hz
Operating Temperature -20°C / +40°C
Installation Height 2-5m • Connection Καλώδιο/Wire
Production Material Πολυκαρβονικό /Polycarbonate



| Code | Barcode | Dimension Ø (mm) † | Cutting Hole (mm) | Color | Watt | Weight (kg) | Packing | MOQ |
|-----------|---------------|--------------------|-------------------|-------|------------|-------------|---------|-----|
| 147-52704 | 5207227427282 | 100 x 32 | 75-90mm | White | MAX 7W LED | 0.04 | 1\100 | 1 |
| 147-52705 | 5207227427305 | 100 x 32 | 75-90mm | Black | MAX 7W LED | 0.04 | 1\100 | 1 |
| 147-52706 | 5207227427329 | 90 x 27 | 75-80mm | White | MAX 7W LED | 0.04 | 1\100 | 1 |
| 147-52707 | 5207227427343 | 90 x 27 | 75-80mm | Black | MAX 7W LED | 0.04 | 1\100 | 1 |

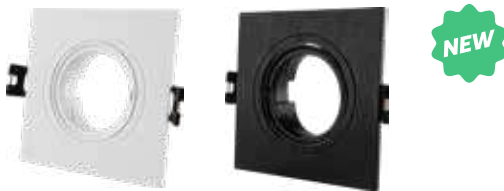

Κινητό Τετράγωνο - Movable Square

Συμπεριλαμβάνεται ντουί
Lampholder included



Volt 12V-240V 50/60Hz
Operating Temperature -20°C / +40°C
Installation Height 2-5m • Connection Καλώδιο/Wire
Production Material Πολυκαρβονικό /Polycarbonate



| Code | Barcode | Dimension (mm) † | Cutting Hole (mm) | Color | Watt | Weight (kg) | Packing | MOQ |
|-----------|---------------|------------------|-------------------|-------|------------|-------------|---------|-----|
| 147-52710 | 5207227427367 | 93 x 93 x 27 | 75-80mm | White | MAX 7W LED | 0.05 | 1\100 | 1 |
| 147-52711 | 5207227427381 | 93 x 93 x 27 | 75-80mm | Black | MAX 7W LED | 0.05 | 1\100 | 1 |



Συμπεριλαμβάνεται ντουί
Lampholder included



Κινητό Διπλό τετράγωνο - Movable Double square

Volt 12V-240V 50/60Hz

Operating Temperature -20°C / +40°C

Installation Height 2-5m • Connection Καλώδιο/Wire

Production Material Πολυκαρβονικό /Polycarbonate



| Code | Barcode | Dimension (mm) | | | Cutting Hole (mm) | Color | Watt | Weight (kg) | Packing | MOQ |
|-----------|---------------|----------------|------|----|-------------------|-------|------------|-------------|---------|-----|
| | | ↗ | ↔ | ↘ | | | | | | |
| 147-52712 | 5207227427404 | 173 x | 93 x | 27 | 80-160mm | White | MAX 7W LED | 0.09 | 1\100 | 1 |
| 147-52713 | 5207227427428 | 173 x | 93 x | 27 | 80-160mm | Black | MAX 7W LED | 0.09 | 1\100 | 1 |



Συμπεριλαμβάνεται ντουί
Lampholder included



Κινητό Τριπλό τετράγωνο - Movable Triple square

Volt 12V-240V 50/60Hz

Operating Temperature -20°C / +40°C

Installation Height 2-5m • Connection Καλώδιο/Wire

Production Material Πολυκαρβονικό /Polycarbonate



| Code | Barcode | Dimension (mm) | | | Cutting Hole (mm) | Color | Watt | Weight (kg) | Packing | MOQ |
|-----------|---------------|----------------|------|----|-------------------|-------|------------|-------------|---------|-----|
| | | ↗ | ↔ | ↘ | | | | | | |
| 147-52714 | 5207227427442 | 225 x | 93 x | 27 | 80-240mm | White | MAX 7W LED | 0.15 | 1\100 | 1 |
| 147-52715 | 5207227427466 | 225 x | 93 x | 27 | 80-240mm | Black | MAX 7W LED | 0.15 | 1\100 | 1 |



Συμπεριλαμβάνεται ντουί
Lampholder included



Σκοτεινής Οπτικής Ø88mm

Volt 12V-240V 50/60Hz

Operating Temperature -20°C / +40°C

Installation Height 2-5m • Connection Καλώδιο/Wire

Production Material Πολυκαρβονικό /Polycarbonate



| Code | Barcode | Dimension | Cutting Hole (mm) | Color | Watt | Weight (kg) | Packing | MOQ |
|-----------|---------------|-----------|-------------------|-------|------------|-------------|---------|-----|
| | | Ø (mm) ↓ | | | | | | |
| 147-52720 | 5207227427480 | 88 x 32 | 75mm | White | MAX 7W LED | 0.03 | 1\100 | 1 |



Σκοτεινής Οπτικής Ø88mm

Συμπεριλαμβάνεται ντουί
Lampholder included



Volt 12V-240V 50/60Hz
Operating Temperature -20°C / +40°C
Installation Height 2-5m • Connection Καλώδιο/Wire
Production Material Πολυκαρβονικό /Polycarbonate



| Code | Barcode | Dimension Ø (mm) † | Cutting Hole (mm) | Color | Watt | Weight (kg) | Packing | MOQ |
|-----------|---------------|-----------------------|----------------------|-------|------------|----------------|---------|-----|
| 147-52721 | 5207227427503 | 88 x 39 | 75mm | White | MAX 7W LED | 0.03 | 1\100 | 1 |



Σκοτεινής Οπτικής Ø93mm

Συμπεριλαμβάνεται ντουί
Lampholder included



Volt 12V-240V 50/60Hz
Operating Temperature -20°C / +40°C
Installation Height 2-5m • Connection Καλώδιο/Wire
Production Material Πολυκαρβονικό /Polycarbonate



| Code | Barcode | Dimension Ø (mm) † | Cutting Hole (mm) | Color | Watt | Weight (kg) | Packing | MOQ |
|-----------|---------------|-----------------------|----------------------|-------|------------|----------------|---------|-----|
| 147-52722 | 5207227427527 | 93 x 53 | 83-87mm | White | MAX 7W LED | 0.04 | 1\100 | 1 |



Σκοτεινής Οπτικής Ø93mm

Συμπεριλαμβάνεται ντουί
Lampholder included



Volt 12V-240V 50/60Hz
Operating Temperature -20°C / +40°C
Installation Height 2-5m • Connection Καλώδιο/Wire
Production Material Πολυκαρβονικό /Polycarbonate



| Code | Barcode | Dimension Ø (mm) † | Cutting Hole (mm) | Color | Watt | Weight (kg) | Packing | MOQ |
|-----------|---------------|-----------------------|----------------------|-------|------------|----------------|---------|-----|
| 147-52723 | 5207227427541 | 93 x 69 | 83-87mm | White | MAX 7W LED | 0.05 | 1\100 | 1 |



Συμπεριλαμβάνεται ντουί
Lampholder included



Κινητό Τετράγωνο- Movable Square

Volt 12V-240V 50/60Hz
Operating Temperature -20°C / +40°C
Installation Height 2-5m · Connection Καλώδιο/Wire
Production Material Πολυκαρβονικό /Polycarbonate



| Code | Barcode | Dimension Ø (mm) † | Color | Watt | Weight (kg) | Packing | MOQ |
|-----------|---------------|-----------------------|-------|------------|----------------|---------|-----|
| 147-52730 | 5207227427565 | 96 x 100 | White | MAX 7W LED | 0.15 | 1\100 | 1 |
| 147-52731 | 5207227427589 | 96 x 100 | Black | MAX 7W LED | 0.15 | 1\100 | 1 |



Συμπεριλαμβάνεται ντουί
Lampholder included



Κινητό Στρογγυλό - Movable Circular

Volt 12V-240V 50/60Hz
Operating Temperature -20°C / +40°C
Installation Height 2-5m · Connection Καλώδιο/Wire
Production Material Πολυκαρβονικό /Polycarbonate



| Code | Barcode | Dimension Ø (mm) † | Color | Watt | Weight (kg) | Packing | MOQ |
|-----------|---------------|-----------------------|-------|------------|----------------|---------|-----|
| 147-52732 | 5207227427602 | 96 x 100 | White | MAX 7W LED | 0.13 | 1\100 | 1 |
| 147-52733 | 5207227427626 | 96 x 100 | Black | MAX 7W LED | 0.13 | 1\100 | 1 |





Ø92mm GU10 Redo

Συμπεριλαμβάνεται ντουί
Lampholder included



Volt 12V-240V 50/60Hz

Operating Temperature -20°C / +40°C

Installation Height 2-5m • Connection Καλώδιο/Wire

Production Material Αλουμίνιο/Aluminium

2
YEARS
WARRANTY

| Code | Barcode | Dimension Ø (mm) † | Cutting Hole (mm) | Color | Watt | Weight (kg) | Packing | MOQ |
|-----------|---------------|-----------------------|----------------------|-------|------------|----------------|---------|-----|
| 147-52530 | 5207227287930 | 95 x 33 | 75mm | White | MAX 7W LED | 0.08 | 1\50 | 1 |
| 147-52531 | 5207227287954 | 95 x 33 | 75mm | Black | MAX 7W LED | 0.08 | 1\50 | 1 |



Ø89mm GU10 Ottavia

Συμπεριλαμβάνεται ντουί
Lampholder included



Volt 12V-240V 50/60Hz

Operating Temperature -20°C / +40°C

Installation Height 2-5m • Connection Καλώδιο/Wire

Production Material Αλουμίνιο/Aluminium

2
YEARS
WARRANTY

| Code | Barcode | Dimension Ø (mm) † | Cutting Hole (mm) | Color | Watt | Weight (kg) | Packing | MOQ |
|-----------|---------------|-----------------------|----------------------|-------|------------|----------------|---------|-----|
| 147-52532 | 5207227287978 | 84 x 33 | 75mm | White | MAX 7W LED | 0.10 | 1\50 | 1 |
| 147-52533 | 5207227287992 | 84 x 33 | 75mm | Black | MAX 7W LED | 0.10 | 1\50 | 1 |



Ø89mm GU10 Ottavia

Συμπεριλαμβάνεται ντουί
Lampholder included



Volt 12V-240V 50/60Hz

Operating Temperature -20°C / +40°C

Installation Height 2-5m • Connection Καλώδιο/Wire

Production Material Αλουμίνιο/Aluminium

2
YEARS
WARRANTY

| Code | Barcode | Dimension Ø (mm) † | Cutting Hole (mm) | Color | Watt | Weight (kg) | Packing | MOQ |
|-----------|---------------|-----------------------|----------------------|-------|------------|----------------|---------|-----|
| 147-52534 | 5207227288012 | 71 x 33 | 60mm | White | MAX 7W LED | 0.07 | 1\40 | 1 |
| 147-52535 | 5207227288036 | 71 x 33 | 60mm | Black | MAX 7W LED | 0.07 | 1\40 | 1 |



Συμπεριλαμβάνεται ντουί
Lampholder included



Ø100mm GU10 Κινητά /Movable Redo

Volt 12V-240V 50/60Hz
Operating Temperature -20°C / +40°C
Installation Height 2-5m • Connection Καλώδιο / Wire
Production Material Αλουμίνιο / Aluminium



| Code | Barcode | Dimension Ø (mm) † | Cutting Hole (mm) | Color | Watt | Weight (kg) | Packing | MOQ |
|-----------|---------------|-----------------------|----------------------|-------|------------|----------------|---------|-----|
| 147-52540 | 5207227288050 | 100 x 25 | 90mm | White | MAX 7W LED | 0.08 | 1\50 | 1 |
| 147-52541 | 5207227288074 | 100 x 25 | 90mm | Black | MAX 7W LED | 0.08 | 1\50 | 1 |



Συμπεριλαμβάνεται ντουί
Lampholder included



Ø93 GU10mm Σταθερό Στεγανό Tex - Fixed Waterproof Tex

Volt 12V-240V 50/60Hz
Operating Temperature -20°C / +40°C
Installation Height 2-5m • Connection Καλώδιο/Wire
Production Material Αλουμίνιο / Aluminium



| Code | Barcode | Dimension Ø (mm) † | Cutting Hole (mm) | Color | Watt | Weight (kg) | Packing | MOQ |
|-----------|---------------|-----------------------|----------------------|-------|------------|----------------|---------|-----|
| 147-52120 | 5207227288098 | 92 x 42 | 75mm | White | MAX 7W LED | 0.12 | 1\50 | 1 |



Συμπεριλαμβάνεται ντουί
Lampholder included



Ø89mm GU10 Σταθερό Στεγανό - Fixed Waterproof

Volt 12V-240V 50/60Hz
Operating Temperature -20°C / +40°C
Installation Height 2-5m • Connection Καλώδιο/Wire
Production Material Αλουμίνιο / Aluminium



| Code | Barcode | Dimension Ø (mm) † | Cutting Hole (mm) | Color | Watt | Weight (kg) | Packing | MOQ |
|-----------|---------------|-----------------------|----------------------|-------|------------|----------------|---------|-----|
| 147-52121 | 5207227288111 | 92 x 45 | 75mm | White | MAX 7W LED | 0.09 | 1\40 | 1 |



Σταθερό PAR16/ GU10 - Fixed PAR16/ GU10

IP20

Volt 12V-240V 50/60Hz
 Operating Temperature -20°C / +40°C
 Installation Height 2-5m • Connection Καλώδιο/Wire
 Production Material Αλουμίνιο/Aluminium

* Συμπεριλαμβάνεται ντουί
 Lampholder included



2
 YEARS
 WARRANTY

| Code | Barcode | Dimension Ø (mm) † | Cutting Hole (mm) | Color | Watt | Weight (kg) | Packing | MOQ |
|-------------|---------------|-----------------------|----------------------|----------------|------------|----------------|---------|-----|
| 147-52510 * | 5207227030864 | 80 x 10 | 60mm | White | MAX 7W LED | 0.035 | 1/100 | 1 |
| 147-52511 * | 5207227125584 | 80 x 10 | 60mm | Black | MAX 7W LED | 0.035 | 1/100 | 1 |
| 147-52513 * | 5207227030888 | 80 x 10 | 60mm | Nickel Satin | MAX 7W LED | 0.035 | 1/100 | 1 |
| 147-55610 | 5206139300102 | 80 x 10 | 60mm | White | MAX 7W LED | 0.036 | 5/100 | 5 |
| 147-55617 | 5207227060243 | 80 x 10 | 60mm | Black | MAX 7W LED | 0.036 | 5/100 | 5 |
| 147-55611 | 5206139300119 | 80 x 10 | 60mm | Gold | MAX 7W LED | 0.036 | 5/100 | 5 |
| 147-55612 | 5206139300126 | 80 x 10 | 60mm | Nickel | MAX 7W LED | 0.036 | 5/100 | 5 |
| 147-55613 | 5206139300133 | 80 x 10 | 60mm | Nickel Satin | MAX 7W LED | 0.036 | 5/100 | 5 |
| 147-55614 | 5206139300140 | 80 x 10 | 60mm | Gold Satin | MAX 7W LED | 0.036 | 5/100 | 5 |
| 147-55615 | 5206139300157 | 80 x 10 | 60mm | Antique Bronze | MAX 7W LED | 0.036 | 5/100 | 5 |
| 147-55616 | 5206139300164 | 80 x 10 | 60mm | Antique Copper | MAX 7W LED | 0.036 | 5/100 | 5 |



Κινητά PAR16/ GU10 - Movable PAR16/ GU10

IP20

Volt 12V-240V 50/60Hz
 Operating Temperature -20°C / +40°C
 Installation Height 2-5m • Connection Καλώδιο/Wire
 Production Material Αλουμίνιο/Aluminium

* Συμπεριλαμβάνεται ντουί
 Lampholder included



2
 YEARS
 WARRANTY

| Code | Barcode | Dimension Ø (mm) † | Cutting Hole (mm) | Color | Watt | Weight (kg) | Packing | MOQ |
|-------------|---------------|-----------------------|----------------------|----------------|------------|----------------|---------|-----|
| 147-52520 * | 5207227030901 | 83 x 10 | 75mm | White | MAX 7W LED | 0.059 | 1/100 | 1 |
| 147-52521 * | 5207227125607 | 83 x 10 | 75mm | Black | MAX 7W LED | 0.059 | 1/100 | 1 |
| 147-52523 * | 5207227030925 | 83 x 10 | 75mm | Nickel Satin | MAX 7W LED | 0.059 | 1/100 | 1 |
| 147-55620 | 5206139300201 | 83 x 10 | 75mm | Black | MAX 7W LED | 0.059 | 5/100 | 5 |
| 147-55621 | 5206139300218 | 83 x 10 | 75mm | White | MAX 7W LED | 0.059 | 5/100 | 5 |
| 147-55622 | 5206139300225 | 83 x 10 | 75mm | Gold | MAX 7W LED | 0.059 | 5/100 | 5 |
| 147-55623 | 5207227060311 | 83 x 10 | 75mm | Nickel | MAX 7W LED | 0.059 | 5/100 | 5 |
| 147-55624 | 5206139300249 | 83 x 10 | 75mm | Nickel Satin | MAX 7W LED | 0.059 | 5/100 | 5 |
| 147-55625 | 5206139300256 | 83 x 10 | 75mm | Gold Satin | MAX 7W LED | 0.059 | 5/100 | 5 |
| 147-55626 | 5206139300263 | 83 x 10 | 75mm | Antique Bronze | MAX 7W LED | 0.059 | 5/100 | 5 |
| 147-55627 | 5206139300270 | 83 x 10 | 75mm | Antique Copper | MAX 7W LED | 0.059 | 5/100 | 5 |



Σποτ Χωνευτά Σταθερά GU10 - Spot Recessed Fixed GU10

IP20

Volt 12V-240V 50/60Hz

Operating Temperature -20°C / +40°C

Installation Height 2-5m

Production Material Αλουμίνιο / Aluminium

2
YEARS
WARRANTY

| Code | Barcode | Dimension (mm) ↕ ↔ ↕ | Cutting Hole (mm) | Color | Watt | Weight (kg) | Packing | MOQ |
|-----------|---------------|-------------------------|-------------------|--------------|------------|-------------|---------|-----|
| 147-52630 | 5207227059612 | 78 x 78 x 59 | 60mm | White | MAX 7W LED | 0.033 | 5/100 | 5 |
| 147-52631 | 5207227059636 | 78 x 78 x 59 | 60mm | Black | MAX 7W LED | 0.033 | 5/100 | 5 |
| 147-52632 | 5207227072277 | 78 x 78 x 59 | 60mm | Nickel Satin | MAX 7W LED | 0.033 | 5/100 | 5 |



Σποτ Χωνευτά Κινητά GU10 - Spot Recessed Movable GU10

IP20

Volt 12V-240V 50/60Hz

Operating Temperature -20°C / +40°C

Installation Height 2-5m

Production Material Αλουμίνιο / Aluminium

2
YEARS
WARRANTY

| Code | Barcode | Dimension (mm) ↕ ↔ ↕ | Cutting Hole (mm) | Color | Watt | Weight (kg) | Packing | MOQ |
|-----------|---------------|-------------------------|-------------------|--------------|------------|-------------|---------|-----|
| 147-52640 | 5207227059674 | 82 x 82 x 23 | 75mm | White | MAX 7W LED | 0.06 | 5/100 | 5 |
| 147-52641 | 5207227059698 | 81 x 81 x 59 | 75mm | Black | MAX 7W LED | 0.06 | 5/100 | 5 |
| 147-52642 | 5207227072284 | 82 x 82 x 23 | 75mm | Nickel Satin | MAX 7W LED | 0.06 | 5/100 | 5 |



Δαχτυλίδι για Σποτάκια 20 τεμάχια - Spot Rings 20 pieces

50/60Hz

Operating Temperature -20°C / +40°C

Installation Height 2-5m

Production Material Μεταλλικό Ασημί / Metallic Silver

| Code | Barcode | Color | Weight (kg) | Packing | MOQ |
|-----------|---------------|--------------|-------------|---------|-----|
| 147-55603 | 5207227293054 | Νίκελ/Nickel | 0.013 | 20/2000 | 1 |



Ø82 GU10 Σταθερό Στεγανο - Ø82 GU10 Fixed Waterproof

IP65

Volt 12V-240V 50/60Hz
Operating Temperature -20°C / +40°C
Installation Height 2-5m • Connection Καλώδιο/Wire
Production Material Αλουμίνιο/Aluminium

2
YEARS
WARRANTY

| Code | Barcode | Dimension Ø (mm) ↓ | Cutting Hole (mm) | Color | Watt | Weight (kg) | Packing | MOQ |
|-----------|---------------|-----------------------|----------------------|--------------|------------|----------------|---------|-----|
| 147-52100 | 5207227019159 | 82 x 38 | 75mm | White | MAX 7W LED | 0.14 | 1\100 | 1 |
| 147-52101 | 5207227019173 | 82 x 38 | 75mm | Nickel Satin | MAX 7W LED | 0.14 | 1\100 | 1 |



82x82 GU10 Σταθερό - 82x82 GU10 Fixed



IP65

Volt 12V-240V 50/60Hz
Operating Temperature -20°C / +40°C
Installation Height 2-5m • Connection Καλώδιο/Wire
Production Material Αλουμίνιο/Aluminium

2
YEARS
WARRANTY

| Code | Barcode | Dimension (mm) ↗ ↖ ↓ | Cutting Hole (mm) | Color | Watt | Weight (kg) | Packing | MOQ |
|-----------|---------------|-------------------------|----------------------|--------------|------------|----------------|---------|-----|
| 147-52110 | 5206139305107 | 82 x 82 x 38 | 75mm | White | MAX 7W LED | 0.14 | 1\100 | 1 |
| 147-52111 | 5206139305114 | 82 x 82 x 38 | 75mm | Nickel Satin | MAX 7W LED | 0.14 | 1\100 | 1 |

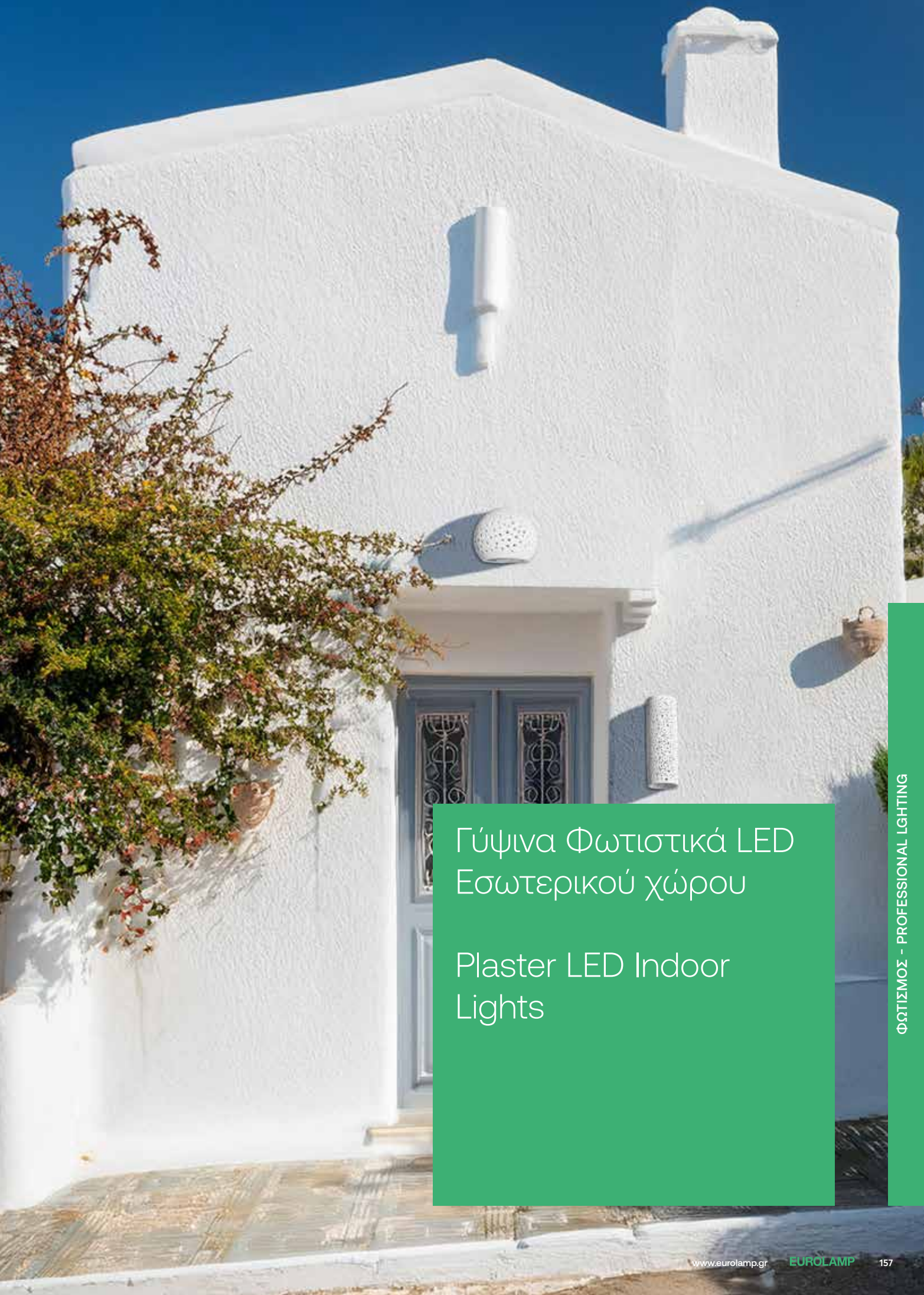



Γύψινα Φωτιστικά LED
Εσωτερικού χώρου

Plaster LED Indoor
Lights



○ Λευκό / White

Σποτ Μονό - Single Spot GU10

IP20

Volt 12V-240V 50/60Hz
 Operating Temperature -20°C / +70°C
 Installation Height 2-5m· Connection Καλώδιο/Wire
 Production Material Γύψος/Plaster

3
 YEARS
 WARRANTY

| Code | Barcode | Dimension (mm) | | | Cutting Dimension (mm) | Watt | Weight (kg) | Packing | MOQ |
|-----------|---------------|----------------|-------|----|------------------------|------------|-------------|---------|-----|
| | | ↗ | ↔ | ↕ | | | | | |
| 147-53200 | 5207227067686 | 100 x | 100 x | 30 | 103 x 103 | MAX 6W LED | 0.272 | 1\30 | 1 |



○ Λευκό / White

Σποτ Μονό - Single Spot GU10

IP20

Volt 12V-240V 50/60Hz
 Operating Temperature -20°C / +70°C
 Installation Height 2-5m· Connection Καλώδιο/Wire
 Production Material Γύψος/Plaster

3
 YEARS
 WARRANTY

| Code | Barcode | Dimension | Cutting Dimension | Watt | Weight (kg) | Packing | MOQ |
|-----------|---------------|-----------|-------------------|------------|-------------|---------|-----|
| | | ∅ (mm) ↕ | | | | | |
| 147-53201 | 5207227067709 | 100 x 40 | 103mm | MAX 6W LED | 0.266 | 1\30 | 1 |



○ Λευκό / White

Σποτ Μονό - Single Spot GU10

IP20

Volt 12V-240V 50/60Hz
 Operating Temperature -20°C / +70°C
 Installation Height 2-5m· Connection Καλώδιο/Wire
 Production Material Γύψος/Plaster

3
 YEARS
 WARRANTY

| Code | Barcode | Dimension (mm) | | | Cutting Dimension | Watt | Weight (kg) | Packing | MOQ |
|-----------|---------------|----------------|-------|----|-------------------|------------|-------------|---------|-----|
| | | ↗ | ↔ | ↕ | | | | | |
| 147-53202 | 5207227067723 | 120 x | 120 x | 62 | 123x123mm | MAX 6W LED | 0.534 | 1\24 | 1 |



○ Λευκό / White

IP20

Σποτ διπλό - Double Spot GU10

3
YEARS
WARRANTY

Volt 12V-240V 50/60Hz
Operating Temperature -20°C / +70°C
Installation Height 2-5m· Connection Καλώδιο/Wire
Production Material Γύψος/Plaster

| Code | Barcode | Dimension (mm) | | | Cutting Dimension | Watt | Weight (kg) | Packing | MOQ |
|-----------|---------------|----------------|-------|----|-------------------|------------|-------------|---------|-----|
| | | ↗ | ↔ | ↕ | | | | | |
| 147-53203 | 5207227067747 | 214 x | 117 x | 60 | 217x120mm | MAX 6W LED | 1.212 | 1\12 | 1 |



○ Λευκό / White

IP20

Σποτ Μονό - Single Spot GU10

3
YEARS
WARRANTY

Volt 12V-240V 50/60Hz
Operating Temperature -20°C / +70°C
Installation Height 2-5m· Connection Καλώδιο/Wire
Production Material Γύψος/Plaster

| Code | Barcode | Dimension (mm) | | | Cutting Dimension | Watt | Weight (kg) | Packing | MOQ |
|-----------|---------------|----------------|------|----|-------------------|------------|-------------|---------|-----|
| | | ↗ | ↔ | ↕ | | | | | |
| 147-53204 | 5207227067761 | 80 x | 80 x | 55 | 83x83mm | MAX 6W LED | 0.362 | 1\30 | 1 |



○ Λευκό / White

IP20

Σποτ Μονό - Single Spot GU10

3
YEARS
WARRANTY

Volt 12V-240V 50/60Hz
Operating Temperature -20°C / +70°C
Installation Height 2-5m· Connection Καλώδιο/Wire
Production Material Γύψος/Plaster

| Code | Barcode | Dimension | Cutting Dimension | Watt | Weight (kg) | Packing | MOQ |
|-----------|---------------|-----------|-------------------|------------|-------------|---------|-----|
| | | ∅ (mm) ↕ | | | | | |
| 147-53205 | 5207227067785 | 100 x 40 | 103mm | MAX 6W LED | 0.172 | 1\30 | 1 |



○ Λευκό / White

Σποτ διπλό - Double Spot GU10

IP20

Volt 12V-240V 50/60Hz
 Operating Temperature -20°C / +70°C
 Installation Height 2-5m · Connection Καλώδιο/Wire
 Production Material Γύψος/Plaster

3
YEARS
WARRANTY

| Code | Barcode | Dimension (mm) ↗ ↔ ↓ | Cutting Dimension | Watt | Weight (kg) | Packing | MOQ |
|-----------|---------------|-------------------------|-------------------|------------|-------------|---------|-----|
| 147-53206 | 5207227067808 | 250 x 135 x 56 | 253x138mm | MAX 6W LED | 1.420 | 1\6 | 1 |



Cutting Dimensions
363x133mm

○ Λευκό / White

Παράλληλόγραμμο - Parallelogram

FLICKER FREE 30.000h ON OFF 15.000 IP20 A PRO SERIES

LED Type XP-E · Chip Brand Cree · Volt 220-240V 50/60Hz
 Start Time 0,5 sec · PF >0,50 · Operating Temperature -20°C / +70°C
 Installation Height 2-3m
 Production Material Γύψος/Plaster

LUMEN / WATT 80 lm/W CRI Ra >80 BEAM ANGLE 45° NON DIMMABLE 2 YEARS WARRANTY

| Code | Barcode | Dimension (mm) ↗ ↔ ↓ | Watt | Amperage mA | Kelvin | Total Lumen | Weight (kg) | Packing | MOQ |
|-----------|---------------|-------------------------|------|-------------|--------|-------------|-------------|---------|-----|
| 147-53207 | 5207227067822 | 360 x 130 x 60 | 1 | 350 | 3000 | 80 | 1.410 | 1\6 | 1 |



Cutting Dimensions
300x163mm

○ Λευκό / White

Παράλληλόγραμμο - Parallelogram

FLICKER FREE 30.000h ON OFF 15.000 IP20 G PRO SERIES

LED Type XP-E · Chip Brand Cree · Volt 220-240V 50/60Hz
 Start Time 0,5 sec · PF >0,50 · Operating Temperature -20°C / +70°C
 Installation Height 2-3m
 Production Material Γύψος/Plaster

LUMEN / WATT 80 lm/W CRI Ra >80 BEAM ANGLE 45° NON DIMMABLE 2 YEARS WARRANTY

| Code | Barcode | Dimension (mm) ↗ ↔ ↓ | Watt | Amperage mA | Kelvin | Total Lumen | Weight (kg) | Packing | MOQ |
|-----------|---------------|-------------------------|------|-------------|--------|-------------|-------------|---------|-----|
| 147-53208 | 5207227067846 | 230 x 145 x 50 | 1 | 350 | 3000 | 80 | 1.420 | 1\6 | 1 |



○ Λευκό / White

Απλικά Τοίχου Οβάλ Medium G9 - Oval Wall Light Medium G9

IP20

Volt 12V-240V 50/60Hz
Operating Temperature -20°C / +70°C
Installation Height 2-5m
Production Material Γύψος/Plaster

3
YEARS
WARRANTY

| Code | Barcode | Dimension (mm) ↗ ↔ ↘ | Watt | Weight (kg) | Packing | MOQ |
|-----------|---------------|-------------------------|------------|-------------|---------|-----|
| 147-53300 | 5207227067860 | 150 x 120 x 100 | MAX 6W LED | 1.090 | 1\12 | 1 |



○ Λευκό / White

Απλικά Τοίχου Κύβος G9 - Cube Wall Light G9

IP20

Volt 12V-240V 50/60Hz
Operating Temperature -20°C / +70°C
Installation Height 2-5m
Production Material Γύψος/Plaster

3
YEARS
WARRANTY

| Code | Barcode | Dimension (mm) ↗ ↔ ↘ | Watt | Weight (kg) | Packing | MOQ |
|-----------|---------------|-------------------------|------------|-------------|---------|-----|
| 147-53301 | 5207227067884 | 140 x 150 x 150 | MAX 6W LED | 1.390 | 1\8 | 1 |



○ Λευκό / White

Απλικά Τοίχου Οβάλ Medium G9 - Oval Wall Light Medium G9

IP20

Volt 12V-240V 50/60Hz
Operating Temperature -20°C / +70°C
Installation Height 2-5m
Production Material Γύψος/Plaster

3
YEARS
WARRANTY

| Code | Barcode | Dimension (mm) ↗ ↔ ↘ | Watt | Weight (kg) | Packing | MOQ |
|-----------|---------------|-------------------------|------------|-------------|---------|-----|
| 147-53302 | 5207227067907 | 200 x 120 x 80 | MAX 6W LED | 0.580 | 1\6 | 1 |



○ Λευκό / White

Απλικά Τοίχου Οβάλ Large G9 - Oval Wall Light Large G9

IP20

Volt 12V-240V 50/60Hz
 Operating Temperature -20°C / +70°C
 Installation Height 2-5m
 Production Material Γύψος/Plaster

3
 YEARS
 WARRANTY

| Code | Barcode | Dimension (mm) | | | Watt | Weight (kg) | Packing | MOQ |
|-----------|---------------|----------------|-------|----|------------|-------------|---------|-----|
| | | ↗ | ↔ | ↘ | | | | |
| 147-53303 | 5207227067921 | 300 x | 140 x | 95 | MAX 6W LED | 1.180 | 1\6 | 1 |



○ Λευκό / White

Απλικά Τοίχου Οβάλ Small G9 - Oval Wall Light Small G9

IP20

Volt 12V-240V 50/60Hz
 Operating Temperature -20°C / +70°C
 Installation Height 2-5m
 Production Material Γύψος/Plaster

3
 YEARS
 WARRANTY

| Code | Barcode | Dimension (mm) | | | Watt | Weight (kg) | Packing | MOQ |
|-----------|---------------|----------------|------|----|------------|-------------|---------|-----|
| | | ↗ | ↔ | ↘ | | | | |
| 147-53304 | 5207227067945 | 180 x | 95 x | 90 | MAX 6W LED | 0.620 | 1\8 | 1 |



○ Λευκό / White

Απλικά Τοίχου Στρογγυλή - Round Wall Light

FLICKER
 FREE

30.000h

ON
 OFF
 15.000

IP20



PRO
 SERIES

LED Type XP-E • Chip Brand Cree • Volt 220-240V 50/60Hz
 Start Time 0,5 sec • PF >0,50 • Operating Temperature -20°C / +70°C
 Installation Height 2-3m
 Production Material Γύψος/Plaster

LUMEN / WATT
 lm/W
 85

CRI
 Ra
 >80

BEAM ANGLE
 180°

NON
 DIMMABLE

2
 YEARS
 WARRANTY

| Code | Barcode | Dimension Ø (mm) ↕ | Watt | Amperage mA | Kelvin | Total Lumen | Weight (kg) | Packing | MOQ |
|-----------|---------------|--------------------|------|-------------|--------|-------------|-------------|---------|-----|
| 147-53305 | 5207227067969 | 155 x 50 | 2X3 | 300 | 3000 | 510 | 0.520 | 1\6 | 1 |



○ Λευκό / White

IP20

Απλικά Τοίχου Στρογγυλή E14 - Round Wall Light E14

3
YEARS
WARRANTY

Volt 12V-240V 50/60Hz
Operating Temperature -20°C / +70°C
Installation Height 2-5m
Production Material Γύψος/Plaster

| Code | Barcode | Dimension (mm) | | | | Watt | Weight (kg) | Packing | MOQ |
|-----------|---------------|----------------|-------|-------|----|------------|-------------|---------|-----|
| | | ∅ | ↗ | ↔ | ↕ | | | | |
| 147-53306 | 5207227067983 | 165 x | 200 x | 180 x | 80 | MAX 6W LED | 1.200 | 1\8 | 1 |



○ Λευκό / White

IP20

Απλικά Τοίχου Οβάλ E14 - Oval Wall Light E14

3
YEARS
WARRANTY

Volt 12V-240V 50/60Hz
Operating Temperature -20°C / +70°C
Installation Height 2-5m
Production Material Γύψος/Plaster

| Code | Barcode | Dimension (mm) | | | Watt | Weight (kg) | Packing | MOQ |
|-----------|---------------|----------------|-------|-----|------------|-------------|---------|-----|
| | | ↗ | ↔ | ↕ | | | | |
| 147-53307 | 5207227068003 | 310 x | 150 x | 110 | MAX 6W LED | 1.220 | 1\9 | 1 |



○ Λευκό / White

IP20

Απλικά Τοίχου Οβάλ E14 - Oval Wall Light E14

3
YEARS
WARRANTY

Volt 12V-240V 50/60Hz
Operating Temperature -20°C / +70°C
Installation Height 2-5m
Production Material Γύψος/Plaster

| Code | Barcode | Dimension (mm) | | | Watt | Weight (kg) | Packing | MOQ |
|-----------|---------------|----------------|-------|----|------------|-------------|---------|-----|
| | | ↗ | ↔ | ↕ | | | | |
| 147-53308 | 5207227068027 | 310 x | 125 x | 95 | MAX 6W LED | 0.820 | 1\6 | 1 |



○ Λευκό / White

Απλικά Τοίχου Οβάλ E14 - Oval Wall Light E14

IP20

Volt 12V-240V 50/60Hz
Operating Temperature -20°C / +70°C
Installation Height 2-5m
Production Material Γύψος/Plaster

3
YEARS
WARRANTY

| Code | Barcode | Dimension (mm) ↕ ↔ ↕ | Watt | Weight (kg) | Packing | MOQ |
|-----------|---------------|-------------------------|------------|-------------|---------|-----|
| 147-53309 | 5207227068041 | 150 x 115 x 125 | MAX 6W LED | 0.790 | 1\8 | 1 |



○ Λευκό / White

Απλικά Τοίχου Up-Down Στρογγυλή GU10 Round Up-Down Wall Light GU10

IP20

Volt 12V-240V 50/60Hz
Operating Temperature -20°C / +70°C
Installation Height 2-5m
Production Material Γύψος/Plaster

3
YEARS
WARRANTY

| Code | Barcode | Dimension (mm) ∅ ↔ ↕ | Watt | Weight (kg) | Packing | MOQ |
|-----------|---------------|-------------------------|------------|-------------|---------|-----|
| 147-53310 | 5207227068065 | 75 x 250 x 100 | MAX 6W LED | 1.480 | 1\6 | 1 |



○ Λευκό / White

Απλικά Τοίχου Up-Down Τετράγωνη GU10 Square Up-Down Wall Light GU10

IP20

Volt 12V-240V 50/60Hz
Operating Temperature -20°C / +70°C
Installation Height 2-5m
Production Material Γύψος/Plaster

3
YEARS
WARRANTY

| Code | Barcode | Dimension (mm) ∅ ↔ ↕ | Watt | Weight (kg) | Packing | MOQ |
|-----------|---------------|-------------------------|------------|-------------|---------|-----|
| 147-53311 | 5207227068089 | 75 x 250 x 100 | MAX 6W LED | 1.582 | 1\6 | 1 |



○ Λευκό / White

Απλικά Τοίχου Up-Down Στρογγυλή E14 Round Up-Down Wall Light E14

IP20

Volt 12V-240V 50/60Hz
Operating Temperature -20°C / +70°C
Installation Height 2-5m • Connection Καλώδιο/Wire
Production Material Γύψος/Plaster

3
YEARS
WARRANTY

| Code | Barcode | Dimension Ø (mm) ↓ | Watt | Weight (kg) | Packing | MOQ |
|-----------|---------------|-----------------------|------------|----------------|---------|-----|
| 147-53312 | 5207227068102 | 110 x 305 | MAX 6W LED | 1.020 | 1\6 | 1 |



○ Λευκό / White

Απλικά Τοίχου Up-Down GU10 Up-Down Wall Light GU10

IP20

Volt 12V-240V 50/60Hz
Operating Temperature -20°C / +70°C
Installation Height 2-5m
Production Material Γύψος/Plaster

3
YEARS
WARRANTY

| | Barcode | Dimension (mm) ↗ ↔ ↓ | Watt | Weight (kg) | Packing | MOQ |
|-----------|---------------|-------------------------|------------|----------------|---------|-----|
| 147-53313 | 5207227068126 | 240 x 120 x 100 | MAX 6W LED | 1.580 | 1\6 | 1 |



○ Λευκό / White

Απλικά Τοίχου Οβάλ E14 - Oval Wall Light E14

IP20

Volt 12V-240V 50/60Hz
Operating Temperature -20°C / +70°C
Installation Height 2-5m
Production Material Γύψος/Plaster

3
YEARS
WARRANTY

| | Barcode | Dimension (mm) ↗ ↔ ↓ | Watt | Weight (kg) | Packing | MOQ |
|-----------|---------------|-------------------------|------------|----------------|---------|-----|
| 147-53314 | 5207227068140 | 200 x 200 x 70 | MAX 6W LED | 1.260 | 1\4 | 1 |



○ Λευκό / White

Ηχείο Οροφής - Ceiling Speaker Ø240x80mm



Volt 100V 90-18khz
 Operating Temperature -10°C / +60°C
 Production Material Αλουμίνιο-Πλαστικό/Aluminium-Plastic



| Code | Barcode | Dimension Ø (mm) † | Watt | Weight (kg) | Packing | MOQ |
|-----------|---------------|-----------------------|------|----------------|---------|-----|
| 147-68973 | 5207227032189 | 240 x 80 | 10 | 1.63 | 1\20 | 1 |





Φωτιστικά LED
Εφεδρικού Φωτισμού

Emergency
LED Lighting



1 ΑΥΤΟΚΟΛΛΗΤΟ
ΔΙΠΛΗΣ ΚΑΤΕΥΘΥΝΣΗΣ
1 SET MULTI DIRECTION
PICTOGRAM

30 SMD LED

Εξωτερικής Τοποθέτησης
Surface Installation

0 | +40 °C

TEST
BUTTON



LED Type 2835 LED • Volt 85-265V 50/60Hz • Battery Type Li-ion 1200mAh
Charging Time 20-24h • Discharging Time 3-4h • IK06
Connection Κλέμμα / Terminal Block Material • Πλαστικό - ABS / PC - ABS

K
KELVIN
6500

IP20

2
YEARS
WARRANTY

| Code | Barcode | Dimension (mm) | | | Watt | Lumen | | Weight (kg) | Packing | MOQ |
|-----------|---------------|----------------|----|----|------|-----------------------------|-------|-------------|---------|-----|
| | | ↕ | ↔ | ↕ | | Continuous / Non-Continuous | | | | |
| 145-28000 | 5207227075544 | 202 | 55 | 28 | 2 | 127 / 62 | 0.142 | 1/40 | 1 | |



1 ΑΥΤΟΚΟΛΛΗΤΟ
ΔΙΠΛΗΣ ΚΑΤΕΥΘΥΝΣΗΣ
1 SET MULTI DIRECTION
PICTOGRAM

60 SMD LED

Εξωτερικής Τοποθέτησης
Surface Installation

0 | +40 °C

TEST
BUTTON



LED Type 2835 LED • Volt 220-240V 50/60Hz • Battery Type Li-ion 1200mAh
Charging Time 20-24h • Discharging Time 3-4h • IK06
Connection Κλέμμα / Terminal Block • Material Πλαστικό - ABS / PC - ABS

K
KELVIN
6500

IP20

2
YEARS
WARRANTY

| Code | Barcode | Dimension (mm) | | | Watt | Lumen | | Weight (kg) | Packing | MOQ |
|-----------|---------------|----------------|----|------|------|-----------------------------|-------|-------------|---------|-----|
| | | ↕ | ↔ | ↕ | | Continuous / Non-Continuous | | | | |
| 145-28001 | 5207227075551 | 250 | 55 | 26.5 | 4 | 353 / 144 | 0.175 | 1/40 | 1 | |



1 ΑΥΤΟΚΟΛΛΗΤΟ
ΔΙΠΛΗΣ ΚΑΤΕΥΘΥΝΣΗΣ
1 SET MULTI DIRECTION
PICTOGRAM

60 SMD LED

Εξωτερικής Τοποθέτησης
Surface Installation

0 | +40 °C

TEST
BUTTON



LED Type 2835 LED • Volt 220-240V 50/60Hz • Battery Type Li-ion 1500mAh
Charging Time 20-24h • Discharging Time 3-4h • IK06
Connection Κλέμμα / Terminal Block • Material Πλαστικό - ABS / PC - ABS

K
KELVIN
6500

IP20

2
YEARS
WARRANTY

| Code | Barcode | Dimension (mm) | | | Watt | Lumen | | Weight (kg) | Packing | MOQ |
|-----------|---------------|----------------|----|----|------|-----------------------------|-------|-------------|---------|-----|
| | | ↕ | ↔ | ↕ | | Continuous / Non-Continuous | | | | |
| 145-28010 | 5207227075568 | 205 | 68 | 31 | 4 | 262 / 107 | 0.165 | 1/40 | 1 | |



10 SMD LED

Δυνατότητα Συνεχούς / Μη Συνεχούς λειτουργίας
Maintained / Non Maintained

Εξωτερικής Τοποθέτησης
Surface Installation

0 | +40 °C

1 ΑΥΤΟΚΟΛΛΗΤΟ
ΔΙΠΛΗΣ ΚΑΤΕΥΘΥΝΣΗΣ
1 SET MULTI DIRECTION
PICTOGRAM

 **TEST**
BUTTON 

LED Type 2835 LED • Volt 220-240V 50/60Hz • Battery Type Li-ion 1200mAh
Charging Time 20-24h • Discharging Time 3-4h • IK06
Connection Κλέμμα / Terminal Block • Material Πλαστικό - ABS / PC - ABS



| Code | Barcode | Dimension (mm) ↕ ↔ ↕ | Watt | Lumen | Weight (kg) | Packing | MOQ |
|-----------|---------------|-------------------------|------|-------|-------------|---------|-----|
| 145-28100 | 5207227075575 | 260 x 107,5 x 46 | 2 | 186 | 0.263 | 1/20 | 1 |



40 SMD LED

Δυνατότητα Συνεχούς / Μη Συνεχούς λειτουργίας
Maintained / Non Maintained

Εξωτερικής Τοποθέτησης
Surface Installation

0 | +40 °C

1 ΑΥΤΟΚΟΛΛΗΤΟ
ΔΙΠΛΗΣ ΚΑΤΕΥΘΥΝΣΗΣ
1 SET MULTI DIRECTION
PICTOGRAM

 **TEST**
BUTTON 

LED Type 2835 LED • Volt 220-240V 50/60Hz • Battery Type Li-ion 2200mAh
Charging Time 20-24h • Discharging Time 3-4h • IK06
Connection Κλέμμα / Terminal Block • Material Πλαστικό - ABS / PC - ABS



| Code | Barcode | Dimension (mm) ↕ ↔ ↕ | Watt | Lumen | Weight (kg) | Packing | MOQ |
|-----------|---------------|-------------------------|------|-------|-------------|---------|-----|
| 145-28110 | 5207227075605 | 355 x 136 x 57.6 | 4 | 278 | 0.449 | 1/10 | 1 |



12 SMD LED

Δυνατότητα Συνεχούς / Μη Συνεχούς λειτουργίας
Maintained / Non Maintained

Εξωτερικής Τοποθέτησης
Surface Installation

+ 5 | +40 °C



1 ΑΥΤΟΚΟΛΛΗΤΟ
ΔΙΠΛΗΣ ΚΑΤΕΥΘΥΝΣΗΣ
1 SET MULTI DIRECTION
PICTOGRAM

 **TEST**
BUTTON 

LED Type 2835 LED • Volt 220-240V 50/60Hz • Battery Type Li-ion 600mAh
Charging Time 20-24h • Discharging Time 3-4h • IK06
Connection Κλέμμα / Terminal Block • Material Πλαστικό / PC



| Code | Barcode | Dimension (mm) ↕ ↔ ↕ | Watt | Lumen Continuous / Non-Continuous | Weight (kg) | Packing | MOQ |
|-----------|---------------|-------------------------|------|--------------------------------------|-------------|---------|-----|
| 145-28120 | 5207227468001 | 240 x 90 x 46 | 3 | 34 / 88 | 0.258 | 1/20 | 1 |



NEW

6 SMD LED

Δυνατότητα Συνεχούς / Μη Συνεχούς λειτουργίας
Maintained / Non Maintained

Εξωτερικής Τοποθέτησης
Surface Installation



+5 | +40 °C



SELF TEST

1 ΑΥΤΟΚΟΛΛΗΤΟ
ΔΙΠΛΗΣ ΚΑΤΕΥΘΥΝΣΗΣ
1 SET MULTI DIRECTION
PICTOGRAM



LED Type 2835 LED • Volt 220-240V 50/60Hz • Battery Type LiFePo4 3.2v 1500mAh
Charging Time 24h • Discharging Time 3h
Connection Κλέμμα / Terminal Block • Material Πλαστικό / PC

K
KELVIN
6500

IP65

5
YEARS
WARRANTY

| Code | Barcode | Dimension (mm) ↗ ↔ ↘ | Watt | Lumen Continuous / Non-Continuous | Weight (kg) | Packing | MOQ |
|-----------|---------------|-------------------------|------|--------------------------------------|----------------|---------|-----|
| 145-28121 | 5207227429897 | 239 x111.60 x49.2 | 1 | 150 | 0.277 | 1/40 | 1 |



NEW

20 SMD LED

Δυνατότητα Συνεχούς / Μη Συνεχούς λειτουργίας
Maintained / Non Maintained

Χωνευτής & Εξωτερικής
Τοποθέτησης
Surface & Recessed
Installation

+5 | +40 °C



SELF TEST

1 ΑΥΤΟΚΟΛΛΗΤΟ
ΔΙΠΛΗΣ ΚΑΤΕΥΘΥΝΣΗΣ
1 SET MULTI DIRECTION
PICTOGRAM



LED Type 2835 LED • Volt 220-240V 50/60Hz • Battery Type LiFePo4 3.2v 3000mAh
Charging Time 24h • Discharging Time 3h
Connection Κλέμμα / Terminal Block • Material Πλαστικό / PC

K
KELVIN
6500

IP65

5
YEARS
WARRANTY

| Code | Barcode | Dimension (mm) ↗ ↔ ↘ | Watt | Lumen Continuous / Non-Continuous | Weight (kg) | Packing | MOQ |
|-----------|---------------|-------------------------|------|--------------------------------------|----------------|---------|-----|
| 145-28122 | 5207227429910 | 261.5 x 118.4 x 37.7 | 3 | 100 | 0.292 | 1/20 | 1 |



NEW

145-28123

145-28124

1 SMD LED

Εξωτερικής Τοποθέτησης
Surface Installation

0 | +55 °C



SELF TEST



LED Type 5050 LED • Volt 220-240V 50/60Hz • Battery Type LiFePo4 3.2v 3300mAh
Charging Time 24h • Discharging Time 3h • IK07
Connection Κλέμμα / Terminal Block • Material Πλαστικό / PC

K
KELVIN
6500

IP65

4
YEARS
WARRANTY

BATTERY
2
YEARS
WARRANTY

| Code | Barcode | Dimension (mm) ↗ ↔ ↘ | Watt | Lumen | Weight (kg) | Packing | MOQ |
|-----------|---------------|-------------------------|------|-------|----------------|---------|-----|
| 145-28123 | 5207227457579 | 155 x 155 x 46 | 2 | 280 | 0.322 | 1/20 | 1 |
| 145-28124 | 5207227457586 | 155 x 155 x 46 | 2 | 280 | 0.313 | 1/20 | 1 |



16 SMD LED

Δυνατότητα Συνεχούς / Μη Συνεχούς Λειτουργίας
Maintained / Non Maintained



1 ΑΥΤΟΚΟΛΛΗΤΟ
ΔΙΠΛΗΣ ΚΑΤΕΥΘΥΝΣΗΣ
1 SET MULTI DIRECTION
PICTOGRAM

LED Type 2835 LED • Volt 220-240V, *110V 50/60Hz • Battery Type LiFePo4 3.2v 1500mAh
Charging Time 24h • Discharging Time 3h • IK10
Connection Κλέμμα / Terminal Block • Material Πλαστικό / PC



| Code | Barcode | Dimension (mm) | | | Watt | Lumen | | Weight (kg) | Packing | MOQ |
|-----------|---------------|----------------|-----|----|------|------------|----------------|-------------|---------|-----|
| | | ↕ | ↔ | ↕ | | Continuous | Non-Continuous | | | |
| 145-28130 | 5207227457593 | 252 | 123 | 65 | 3.5 | 150 | 0.500 | 1/20 | 1 | |
| 145-28131 | 5207227457609 | 252 | 123 | 65 | 3 | 300 | 0.540 | 1/20 | 1 | |

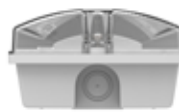

Χωνευτής & Εξωτερικής
Τοποθέτησης
Surface & Recessed
Installation

| Code | Barcode | Dimension (mm) | | | Watt | Lumen | | Weight (kg) | Packing | MOQ |
|------------|---------------|----------------|-----|----|------|------------|----------------|-------------|---------|-----|
| | | ↕ | ↔ | ↕ | | Continuous | Non-Continuous | | | |
| 145-28132 | 5207227457616 | 355 | 115 | 63 | 3.3 | 150 | 0.655 | 1/20 | 1 | |
| 145-28133 | 5207227457623 | 355 | 115 | 63 | 4,8 | 300 | 0.700 | 1/20 | 1 | |
| 145-28134* | 5207227457630 | 355 | 115 | 63 | 3 | 150 | 0.700 | 1/20 | 1 | |

Βάση χωνευτή για 145-28132, 145-28133, 145-28134

Χωνευτής Τοποθέτησης
Recessed Installation

Cutting Dimensions 120x350mm • Operating Temperature 0°C / +55°C
Material Πλαστικό / PC

| Code | Barcode | Dimension (mm) | | | Weight (kg) | Packing | MOQ |
|-----------|---------------|----------------|-------|------|-------------|---------|-----|
| | | ↕ | ↔ | ↕ | | | |
| 145-28135 | 5207227457647 | 388 | 163,8 | 40,5 | 0.500 | 1/10 | 1 |

Κάλυμμα οροφής για 145-28132, 145-28133, 145-28134

Εξωτερικής Τοποθέτησης
Surface Installation

Cutting Dimensions 120x350mm • Operating Temperature 0°C / +55°C
Material Πλαστικό / PC

| Code | Barcode | Dimension (mm) | | | Weight (kg) | Packing | MOQ |
|-----------|---------------|----------------|-----|----|-------------|---------|-----|
| | | ↕ | ↔ | ↕ | | | |
| 145-28136 | 5207227457654 | 355 | 115 | 63 | 0.750 | 1/10 | 1 |



Για τους κωδικούς:
145-28132
145-28133
145-28134





Spot 2 SMD LED

Χωνευτής Τοποθέτησης
Recessed Installation

0 | +55 °C

SELF TEST



LED Type 3535 LED • Volt 220-240V 50/60Hz • Battery Type LiFePo4 3.2v 1500mAh
Charging Time 24h • Discharging Time 3h • IK07
Connection Κλέμμα / Terminal Block • Material Πλαστικό / PC

| | | | |
|-----------------------------------|-----------------|-------------------------------|---|
| K KELVIN 6500 | IP20 | 4 YEARS WARRANTY | BATTERY 2 YEARS WARRANTY |
|-----------------------------------|-----------------|-------------------------------|---|

| Code | Barcode | Dimension (mm) ↗ ↔ ↘ | Watt | Lumen | Weight (kg) | Packing | MOQ |
|-----------|---------------|-------------------------|------|---------|-------------|---------|-----|
| 145-28140 | 5207227457661 | 250 x 36 x 27 | 1.2 | 140-160 | 0.182 | 1/20 | 1 |



2X2,2W SMD LED

Εξωτερικής Τοποθέτησης
Surface Installation

0 | +55 °C

SELF TEST



LED Type 2835 LED • Volt 220-240V 50/60Hz • Battery Type LiFePO4 9.6V 1500mAh
Charging Time 24h • Discharging Time 3h • IK07
Connection Κλέμμα / Terminal Block • Material Πλαστικό - ABS / PC - ABS

| | | | |
|-----------------------------------|-----------------|-------------------------------|---|
| K KELVIN 6500 | IP20 | 4 YEARS WARRANTY | BATTERY 2 YEARS WARRANTY |
|-----------------------------------|-----------------|-------------------------------|---|

| Code | Barcode | Dimension (mm) ↗ ↔ ↘ | Watt | Lumen | Weight (kg) | Packing | MOQ |
|-----------|---------------|-------------------------|-------|-------|-------------|---------|-----|
| 145-28601 | 5207227467998 | 275 x 270 x 55 | 2X2.2 | 300 | 0.706 | 1/50 | 1 |



Τοίχου / Wall 24 SMD LED

Δυνατότητα Συνεχούς / Μη Συνεχούς λειτουργίας
Maintained / Non Maintained

Εξωτερικής Τοποθέτησης
Surface Installation

0 | +55 °C

SELF TEST



LED Type 2835 LED • Volt 220-240V 50/60Hz • Battery Type LiFePo4 3.2v 1500mAh
Charging Time 24h • Discharging Time 3h • IK07
Connection Κλέμμα / Terminal Block • Material Πλαστικό / PC

| | | | |
|-----------------------------------|-----------------|-------------------------------|---|
| K KELVIN 6500 | IP20 | 4 YEARS WARRANTY | BATTERY 2 YEARS WARRANTY |
|-----------------------------------|-----------------|-------------------------------|---|

| Code | Barcode | Dimension (mm) ↗ ↔ ↘ | Watt | View Distance | Weight (kg) | Packing | MOQ |
|-----------|---------------|-------------------------|------|---------------|-------------|---------|-----|
| 145-28150 | 5207227457678 | 330 x 185 x 29 | 3.5 | 30m | 0.635 | 1/20 | 1 |



Δυνατότητα Συνεχούς / Μη Συνεχούς λειτουργίας
Maintained / Non Maintained

Χωνευτής & Εξωτερικής Τοποθέτησης
Surface & Recessed Installation

SMD LED Οροφής - Τοίχου / Ceiling - Wall

2
STICKER
SET

0 | +55 °C

SELF
TEST



LED Type 2835 LED • Volt 220-240V 50/60Hz • Battery Type LiFePo4 3.2v 1100mAh
Charging Time 24h • Discharging Time 3h • IK07
Connection Κλέμμα / Terminal Block • Material Πλαστικό / PC

| | | | |
|---------------------|------|------------------------|-----------------------------------|
| K KELVIN 6500 | IP20 | 4 YEARS WARRANTY | BATTERY 2 YEARS WARRANTY |
|---------------------|------|------------------------|-----------------------------------|

| Code | Barcode | Dimension (mm) ↕ ↔ ↴ | Watt | View Distance | Weight (kg) | Packing | MOQ |
|-----------|---------------|-------------------------|------|------------------|----------------|---------|-----|
| 145-28151 | 5207227457685 | 313 x 212 x 42 | 2.2 | 30m | 0.522 | 1/20 | 1 |

Βάση οροφής για το 145-28151

Εξωτερικής Τοποθέτησης
Surface Installation

Operating Temperature 0°C / +55°C • Material Πλαστικό / PC

| Code | Barcode | Dimension (mm) ↕ ↔ ↴ | Weight (kg) | Packing | MOQ |
|-----------|---------------|-------------------------|----------------|---------|-----|
| 145-28152 | 5207227457692 | 313 x 18 x 42 | 0.172 | 1/50 | 1 |

Βάση τοίχου γωνία για το 145-28151

Εξωτερικής Τοποθέτησης
Surface Installation

Operating Temperature 0°C / +55°C • Material Πλαστικό / PC

| Code | Barcode | Dimension (mm) ↕ ↔ ↴ | Weight (kg) | Packing | MOQ |
|-----------|---------------|-------------------------|----------------|---------|-----|
| 145-28153 | 5207227457708 | 189.7 x 40 x 84 | 0.120 | 1/50 | 1 |

Βάση χωνευτή για το 145-28151

Χωνευτής Τοποθέτησης
Recessed Installation

Cutting Dimensions 50x320mm • Operating Temperature 0°C / +55°C
Material Πλαστικό / PC

| Code | Barcode | Dimension (mm) ↕ ↔ ↴ | Weight (kg) | Packing | MOQ |
|-----------|---------------|-------------------------|----------------|---------|-----|
| 145-28154 | 5207227457715 | 349.5x120.8x68.4 | 0.120 | 1/50 | 1 |



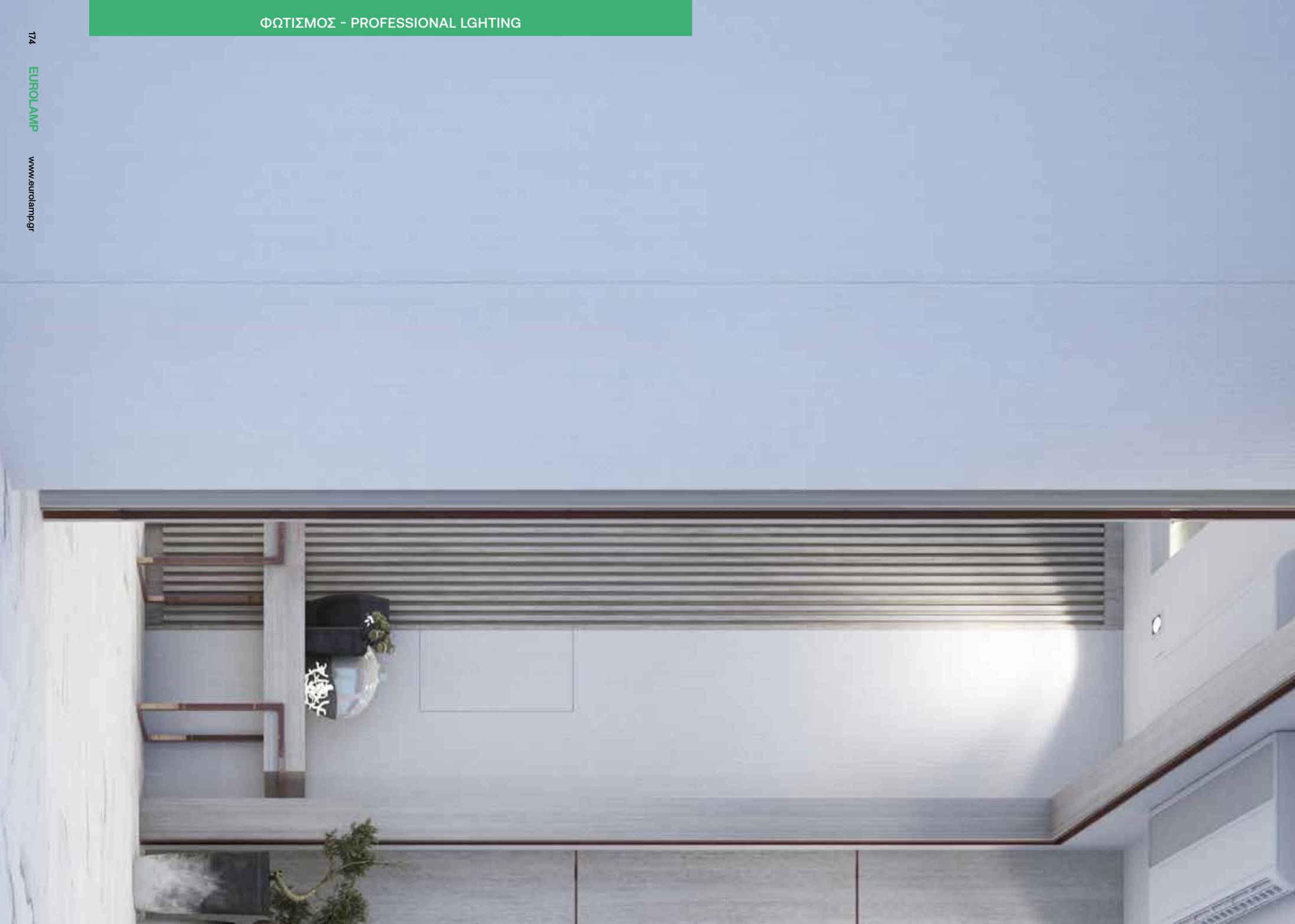



Ταινίες LED

LED Strips

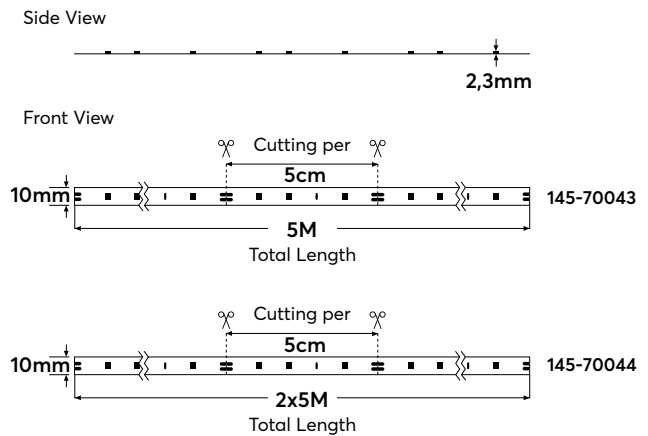

KIT LED Strip SMD RGB + Driver + Wifi Controller with Music



Volt 12V • LED Type SMD5050 • Chip Brand Sanan
 Start Time 0,5 sec • Operating Temperature -20°C / +40°C
 Material Χαλκός - Πλαστικό / Copper - Plastic

| | | | |
|--------------|--------------------|----------|------------------------|
| Chip/m 18 | BEAM ANGLE 120° | DIMMABLE | 2 YEARS WARRANTY |
|--------------|--------------------|----------|------------------------|

| Code | Barcode | Watt | Amperage mA | Kelvin | Lm/Watt | Packing | MOQ |
|-----------|---------------|------|-------------|--------|---------|---------|-----|
| 145-70043 | 5207227140419 | 12 | 1000 | RGB | - | 1/40 | 1 |
| 145-70044 | 5207227140426 | 24 | 1000 | RGB | - | 1/40 | 1 |



145-70046



145-70047

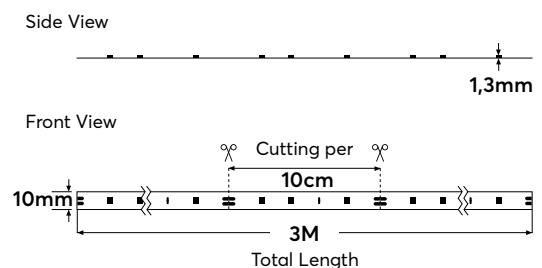

KIT LED Strip SMD + Driver + Wifi Controller

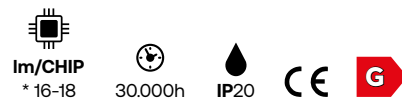

Volt 200-240V 50/60Hz • LED Type SMD5050 • Chip Brand Sanan / Qiqin
 Start Time 0,5 sec • Operating Temperature -20°C / +40°C
 Material Χαλκός - Πλαστικό / Copper - Plastic

| | | | | |
|--------------|--------------------|--------------------|----------|------------------------|
| Chip/m 30 | CRI Ra * >80 | BEAM ANGLE 120° | DIMMABLE | 2 YEARS WARRANTY |
|--------------|--------------------|--------------------|----------|------------------------|

| Code | Barcode | Watt | Amperage mA | Kelvin | Lm/Watt | Packing | MOQ |
|------------|---------------|------|-------------|--------|---------|---------|-----|
| 145-70046* | 5207227471582 | 16 | 1500 | 4000 | 75 | 1/20 | 1 |
| 145-70047 | 5207227471568 | 15 | 1500 | RGB | - | 1/20 | 1 |

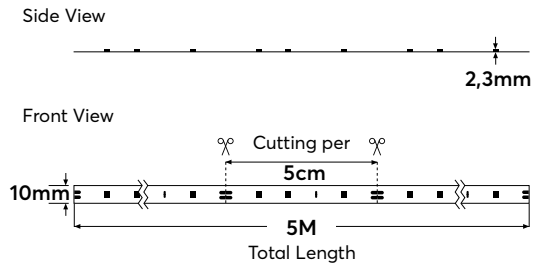

KIT LED Strip SMD PIXEL RGB + Driver + Wifi Controller with Music



Volt 12V • LED Type SMD5050 • Chip Brand Sanan
 Start Time 0,5 sec • Operating Temperature -20°C / +40°C
 Material Χαλκός - Πλαστικό / Copper - Plastic

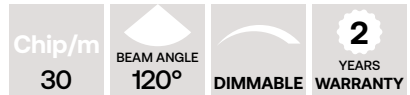

| Code | Barcode | Watt | Amperage mA | Kelvin | Lm/Watt | Packing | MOQ |
|-----------|---------------|------|-------------|-----------|---------|---------|-----|
| 145-70045 | 5207227140433 | 18 | 1500 | PIXEL RGB | - | 1/40 | 1 |



Λειτουργία με μπαταρίες /
 Battery function:
 4xAAA

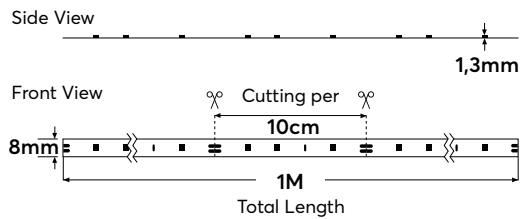

LED Strip SMD 1m with Pir Motion Sensor



Volt 6V • LED Type SMD2835 • Chip Brand Sanan
 Start Time 0,5 sec • Operating Temperature -20°C / +40°C
 Material Χαλκός - Πλαστικό / Copper - Plastic

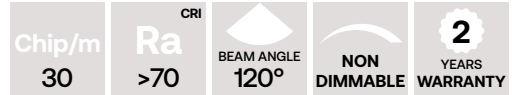

| Code | Barcode | Watt | Amperage mA | Kelvin | Lm/Watt | Packing | MOQ |
|-----------|---------------|------|-------------|--------|---------|---------|-----|
| 145-70024 | 5207227098758 | 2.4 | 400 | 3000 | 70 | 1/40 | 1 |

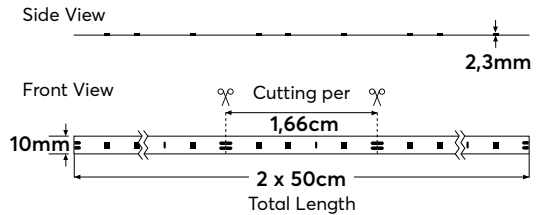

LED Strip SMD RGB SET 2 PCS USB Connection



Volt 5V • LED Type SMD5050 • Chip Brand Sanan
 Start Time 0,5 sec • Operating Temperature -20°C / +40°C
 Material Χαλκός - Πλαστικό / Copper - Plastic

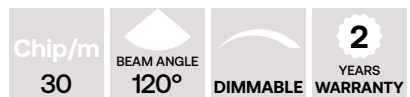

| Code | Barcode | Watt | Amperage mA | Kelvin | Lm/Watt | Packing | MOQ |
|-----------|---------------|------|-------------|--------|---------|---------|-----|
| 145-70025 | 5207227098765 | 7,2 | 1440 | RGB | - | 1/40 | 1 |

NEON

TECHNOLOGY

SMD

FLEX LED STRIP

Οι LED ταινίες τεχνολογίας Neon Flex αποτελούν ένα εύκαμπτο προϊόν με βάση τη σιλικόνη, ενσωματωμένο με LED, το οποίο είναι σχεδιασμένο να μιμείται το γυάλινο νέον. Η λέξη «flex» αναφέρεται στο γεγονός ότι είναι τοποθετημένα σε μια εύκαμπτη ταινία. Μπορούν να χρησιμοποιηθούν για εσωτερικές και εξωτερικές εφαρμογές. Σημαντική είναι η επίτευξη ποικιλίας οπτικών εφέ, όπως, στατικό φως, μονόχρωμο, πολλαπλά χρώματα και δυναμική κίνηση. Όλα τα παραπάνω τις καθιστούν ιδανικές για τη δημιουργία σύγχρονων, ενεργειακά αποδοτικών επιγραφών νέον LED και φωτισμού έμφασης για κτίρια και εσωτερικούς χώρους. Επιπλέον, για την προστασία των λυχνιών LED νέον και της πλακέτας κυκλώματος, οι εύκαμπτες λυχνίες LED νέον καλύπτονται με ένα διαφανές κάλυμμα από PVC ή σιλικόνη. Αυτά τα δομικά χαρακτηριστικά τις καθιστούν εξαιρετικά ευέλικτες και εύχρηστες.

ΠΛΕΟΝΕΚΤΗΜΑΤΑ ΠΡΟΪΟΝΤΟΣ

- Σταθερός ρυθμιζόμενος φωτισμός σε όλη την ελαστική ταινία LED νέον.
- Απεριόριστη ελευθερία σχεδιασμού και τοποθέτησης του υλικού.
- Μεγάλη διάρκεια ζωής και ανθεκτικές.
- Απλή σύνδεση χάρη στα ενσωματωμένα καλώδια και στις δύο πλευρές.
- Μέγιστη ευελιξία χάρη στη μεγάλη γκάμα αξεσουάρ.
- Είναι ενεργειακά αποδοτικές, με ελάχιστη ισχύ μικρότερη από 5W ανά μέτρο.

Neon Flex technology LED strips are a flexible product with base the silicone, integrated with LED, which is designed to mimic the glass neon. The word 'flex' refers to the fact that they are placed in a flexible tape. They can be used for indoor and outdoor applications. They achieve a variety of visual effects, such as static light, monochrome, multiple colors and dynamic movement. All of the above make them ideal for creating modern, energy efficient LED neon signs and accent lighting for buildings and interiors places.

In addition, to protect the neon LEDs and the board circuit, the flexible neon LEDs are covered with a transparent PVC or silicone cover. These structural features make them extremely flexible and easy to use.

PRODUCT ADVANTAGES

- Steady and adjustable lighting throughout the elastic LED neon strip.
- Unlimited freedom of design and placement of the material.
- Long life and durable.
- Simple connection thanks to integrated cables on both sides.
- Maximum flexibility thanks to the wide range of accessories.
- They are energy efficient, with a minimum power of less than 5W per meter.

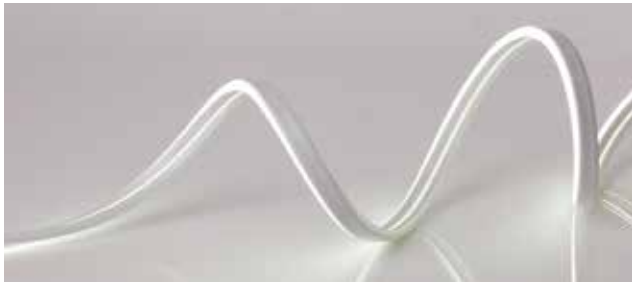

LED Neon Flex Light

Volt 24V • LED Type SMD2835 • Chip Brand Sanan
 Start Time 0,5 sec • Operating Temperature 0°C / +40°C
 Material Χαλκός - Πλαστικό / Copper - Plastic

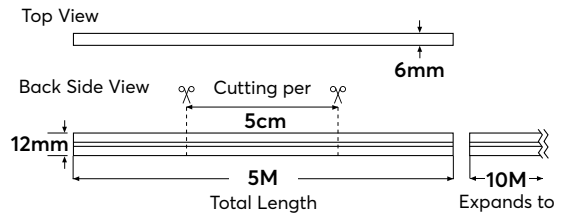

| | | | | |
|---------------|------------------|--------------------|----------|------------------------|
| Chip/m 120 | CRI Ra >80 | BEAM ANGLE 120° | DIMMABLE | 3 YEARS WARRANTY |
|---------------|------------------|--------------------|----------|------------------------|

| Code | Barcode | Watt | Amperage mA | Kelvin | Lm/Watt | Packing | MOQ |
|-----------|---------------|------|-------------|--------|---------|---------|-----|
| 145-73000 | 5207227242694 | 8 | 670 | 6500 | 40 | 1/50 | 5m |
| 145-73001 | 5207227242717 | 8 | 670 | 4000 | 35 | 1/50 | 5m |
| 145-73002 | 5207227242731 | 8 | 670 | 3000 | 30 | 1/50 | 5m |
| 145-73003 | 5207227242755 | 8 | 670 | 2700 | 28 | 1/50 | 5m |

ΣΥΝΔΥΑΖΟΝΤΑΙ ΜΕ / COMBINED WITH: **145-73950 / 145-73951 / 145-73952 / 145-73953 / 145-73954** > **214** ΣΕΛΙΔΑ / PAGE

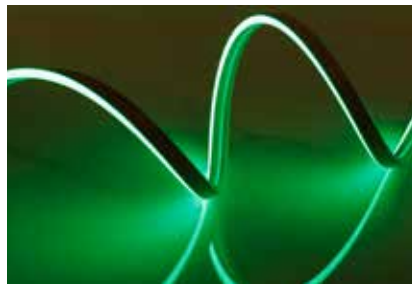
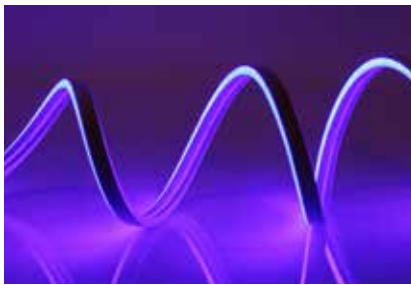

| Code | Barcode | Watt | Amperage mA | Kelvin | Packing | MOQ |
|-----------|---------------|------|-------------|----------|---------|-----|
| 145-73004 | 5207227232794 | 8 | 670 | BLUE | 1/50 | 5m |
| 145-73005 | 5207227232817 | 8 | 670 | GREEN | 1/50 | 5m |
| 145-73006 | 5207227232831 | 8 | 670 | RED | 1/50 | 5m |
| 145-73007 | 5207227232855 | 8 | 670 | YELLOW | 1/50 | 5m |
| 145-73008 | 5207227232879 | 8 | 670 | PURPLE | 1/50 | 5m |
| 145-73009 | 5207227242779 | 8 | 670 | ORANGE | 1/50 | 5m |
| 145-73010 | 5207227242793 | 8 | 670 | ICE BLUE | 1/50 | 5m |
| 145-73011 | 5207227242816 | 8 | 670 | PINK | 1/50 | 5m |

ΣΥΝΔΥΑΖΟΝΤΑΙ ΜΕ / COMBINED WITH: **145-73950 / 145-73951 / 145-73952 / 145-73953 / 145-73954** > **214** ΣΕΛΙΔΑ / PAGE

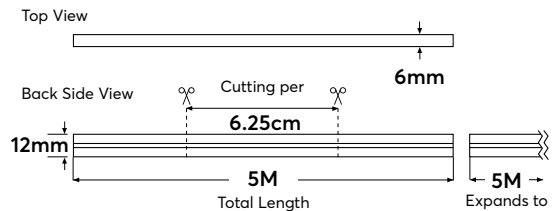

LED Neon Flex Light Pixel

| Code | Barcode | Watt | Amperage mA | Kelvin | Packing | MOQ |
|-----------|---------------|------|-------------|-----------|---------|-----|
| 145-73012 | 5207227437380 | 8 | 333 | PIXEL RGB | 1/50 | 5m |

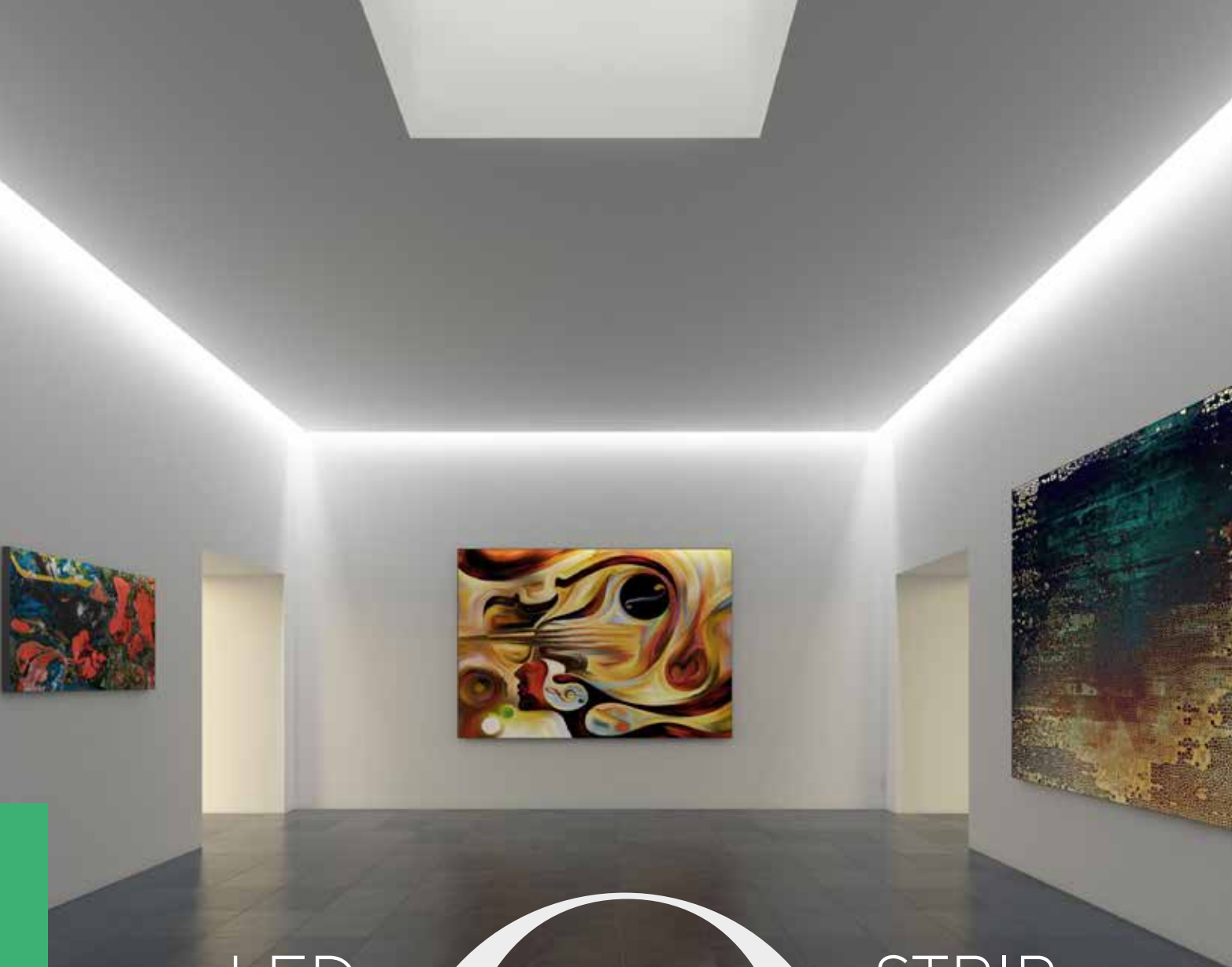

LED STRIP

COOB

NO DOTS

LED STRIP

TECHNOLOGY

COB

Με τις LED ταινίες τεχνολογίας COB δεν θα βλέπετε πλέον τα φωτεινά σημεία που είναι τυπικά των συμβατικών ταινιών LED. Αυτό συμβαίνει επειδή υπάρχουν τόσα πολλά τσιπ LED που, σε συνδυασμό με ένα στρώμα φωσφόρου, παράγεται μια **εντυπωσιακά ομοιόμορφη γραμμή φωτός** σε όλο το μήκος τους. Το μέγιστο μήκος μιας ταινίας LED ποικίλλει από εφαρμογή σε εφαρμογή και εξαρτάται σε μεγάλο βαθμό από τη γραμμή τροφοδοσίας μεταξύ του τροφοδοτικού και της ταινίας. Ανάλογα με το μήκος και τη διατομή αυτής της γραμμής τροφοδοσίας, μπορεί να καταγραφεί πτώση τάσης η οποία από ένα συγκεκριμένο σημείο έχει αρνητική επίδραση στην απόδοση των ταινιών LED.

ΠΛΕΟΝΕΚΤΗΜΑΤΑ ΠΡΟΪΟΝΤΟΣ

- Εξαιρετικό ομοιογενές φως, χωρίς ορατά σημεία φωτός χάρη στην τεχνολογία COB
- Μεγάλη σχεδιαστική ελευθερία χάρη στην ευελιξία και την ικανότητα κοπής της ταινίας
- Υψηλή χρωματική απόδοση που τα καθιστά ιδανικά για μοντέρνο, αποκλειστικό σχεδιασμό φωτισμού, ειδικά στους επαγγελματικούς χώρους
- Εύκολη τοποθέτηση σε πολλές λείες επιφάνειες με αυτοκόλλητη ταινία στο πίσω μέρος
- Απλή σύνδεση χάρη στα ενσωματωμένα καλώδια και στις δύο πλευρές
- Μέγιστη ευελιξία χάρη στη μεγάλη γκάμα αξεσουάρ
- Εύκολη εγκατάσταση, δεν απαιτούνται εργαλεία για τη σύνδεση

With COB technology LED strips you will no longer see the bright ones points that are on conventional LED strips. This is because there are so many LED combined with a phosphor layer, and they create an **impressively even line of light** on their entire length. The maximum length of an LED strip varies from application to application and is highly dependent on the power line between it power supply and the tape. Depending on its length and cross-section supply line, a voltage drop can be recorded which from a certain point has a negative effect on the performance of LED strips.

PRODUCT ADVANTAGES

- Excellent homogeneous light with no visible light spots thanks to COB technology
- Great design freedom thanks to the flexibility and ability to cut the tape
- High color rendering that makes them ideal for modern, exclusive design lighting, especially in business areas
- Easy to attach to many smooth surfaces with adhesive tape on the back
- Simple connection thanks to integrated cables on both sides
- Maximum flexibility thanks to the wide range of accessories
- Easy installation, no tools required for connection

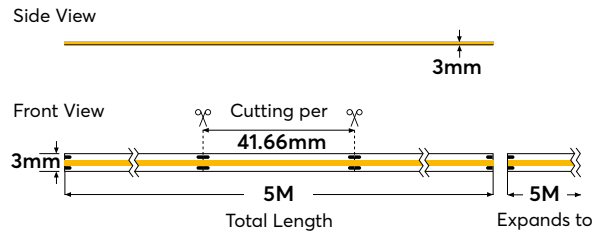

Super Slim COB 5m 7W 24V



lm/CHIP 9-9,5
 25.000h
 IP20

Volt 24V • LED Type COB • Chip Brand Sanan
 Start Time 0,5 sec • Operating Temperature 0°C / +40°C
 Material Χαλκός - Πλαστικό / Copper - Plastic

Chip/m 384
 Ra >80
 BEAM ANGLE 180°
 DIMMABLE
 3 YEARS WARRANTY

| Code | Barcode | Watt | Amperage mA | Kelvin | Lm/Watt | Packing | MOQ |
|-----------|---------------|------|-------------|--------|---------|----------|-----|
| 145-72005 | 5207227436949 | 7 | 292 | 6500 | 90 | 1/25/100 | 5m |
| 145-72006 | 5207227436970 | 7 | 292 | 4000 | 80 | 1/25/100 | 5m |
| 145-72007 | 5207227437007 | 7 | 292 | 3000 | 70 | 1/25/100 | 5m |
| 145-72008 | 5207227437038 | 7 | 417 | 2700 | 65 | 1/25/100 | 5m |

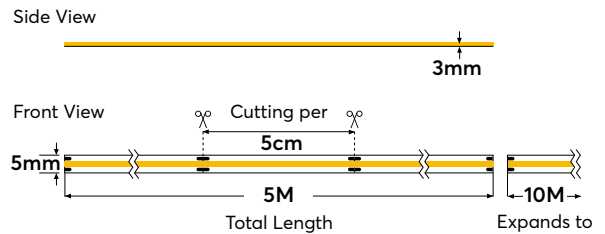

Mini COB 5m 10W 24V

lm/CHIP 9-9,5
 25.000h
 IP44

Volt 24V • LED Type COB • Chip Brand Sanan
 Start Time 0,5 sec • Operating Temperature 0°C / +40°C
 Material Χαλκός - Πλαστικό / Copper - Plastic

Chip/m 320
 Ra >90
 BEAM ANGLE 180°
 DIMMABLE
 3 YEARS WARRANTY

| Code | Barcode | Watt | Amperage mA | Kelvin | Lm/Watt | Packing | MOQ |
|-----------|---------------|------|-------------|--------|---------|----------|-----|
| 145-72000 | 5207227241024 | 10 | 416 | 6500 | 95-100 | 1/25/100 | 5m |
| 145-72001 | 5207227241055 | 10 | 416 | 4000 | 90-95 | 1/25/100 | 5m |
| 145-72002 | 5207227241086 | 10 | 416 | 3000 | 80-85 | 1/25/100 | 5m |
| 145-72003 | 5207227241116 | 10 | 416 | 2700 | 80-85 | 1/25/100 | 5m |

ΣΥΝΔΥΑΖΟΝΤΑΙ ΜΕ / COMBINED WITH: **145-72900 / 145-72901 / 145-72902 / 145-72903** > **214** ΣΕΛΙΔΑ / PAGE



Side View



Front View

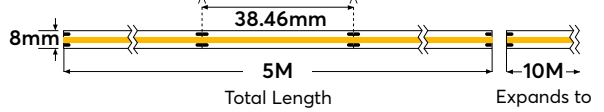

COB 10m 10W 24V



Volt 24V • LED Type COB • Chip Brand Sanan
 Start Time 0,5 sec • Operating Temperature 0°C / +40°C
 Material Χαλκός - Πλαστικό / Copper - Plastic

| | | | | |
|---------------|------------------|--------------------|----------|------------------------|
| Chip/m 312 | CRI Ra >80 | BEAM ANGLE 180° | DIMMABLE | 3 YEARS WARRANTY |
|---------------|------------------|--------------------|----------|------------------------|

| Code | Barcode | Watt | Amperage mA | Kelvin | Lm/Watt | Packing | MOQ |
|-----------|---------------|------|-------------|--------|---------|----------|-----|
| 145-72010 | 5207227437069 | 10 | 417 | 6500 | 100 | 1/25/100 | 10m |
| 145-72011 | 5207227437090 | 10 | 417 | 4000 | 90 | 1/25/100 | 10m |
| 145-72012 | 5207227437120 | 10 | 417 | 3000 | 87 | 1/25/100 | 10m |
| 145-72013 | 5207227437151 | 10 | 417 | 2700 | 84 | 1/25/100 | 10m |

ΣΥΝΔΥΑΖΟΝΤΑΙ ΜΕ / COMBINED WITH: 145-72910 / 145-72912 / 145-72911 / 145-72913 / 145-72914 / 145-72915 > 215 ΣΕΛΙΔΑ / PAGE



Side View



Front View

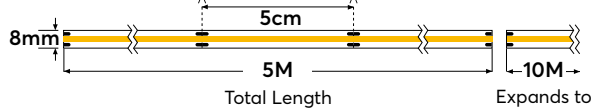

COB 5m 12W 24V

Volt 24V • LED Type COB • Chip Brand Sanan
 Start Time 0,5 sec • Operating Temperature 0°C / +40°C
 Material Χαλκός - Πλαστικό / Copper - Plastic



| | | | | | |
|---------------|--------------------|---------------------|--------------------|----------|------------------------|
| Chip/m 480 | CRI Ra * >90 | CRI Ra ** >80 | BEAM ANGLE 180° | DIMMABLE | 3 YEARS WARRANTY |
|---------------|--------------------|---------------------|--------------------|----------|------------------------|

| Code | Barcode | Watt | Amperage mA | Kelvin | Lm/Watt | Packing | MOQ |
|--------------|---------------|------|-------------|--------|---------|----------|-----|
| 145-72020 * | 5207227241147 | 12 | 500 | 6500 | 95-100 | 1/25/100 | 5m |
| 145-72021 * | 5207227241178 | 12 | 500 | 4000 | 90-95 | 1/25/100 | 5m |
| 145-72022 * | 5207227241208 | 12 | 500 | 3000 | 80-85 | 1/25/100 | 5m |
| 145-72023 * | 5207227241239 | 12 | 500 | 2700 | 80-85 | 1/25/100 | 5m |
| 145-72024 | 5207227241260 | 12 | 500 | RED | - | 1/25/100 | 5m |
| 145-72025 | 5207227241291 | 12 | 500 | BLUE | - | 1/25/100 | 5m |
| 145-72026 | 5207227241321 | 12 | 500 | GREEN | - | 1/25/100 | 5m |
| 145-72027 ** | 5207227241352 | 12 | 500 | YELLOW | - | 1/25/100 | 5m |

ΣΥΝΔΥΑΖΟΝΤΑΙ ΜΕ / COMBINED WITH: 145-72910 / 145-72912 / 145-72911 / 145-72913 / 145-72914 / 145-72915 > 215 ΣΕΛΙΔΑ / PAGE

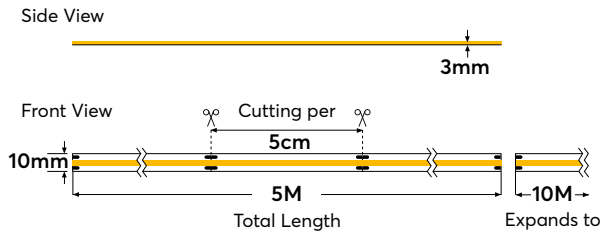

CCT COB 5m 12W 24V



lm/CHIP 9-9,5
 25.000h
 IP44

Volt 24V • LED Type COB • Chip Brand Sanan
 Start Time 0,5 sec • Operating Temperature 0°C / +40°C
 Material Χαλκός - Πλαστικό / Copper - Plastic

Chip/m 640
 CRI Ra >80
 BEAM ANGLE 180°
 DIMMABLE
 3 YEARS WARRANTY

| Code | Barcode | Watt | Amperage mA | Kelvin | Lm/Watt | Packing | MOQ |
|----------------------------------|---------------|------|-----------------------------------|-----------|---------|----------|---------------------|
| 145-72028 | 5207227241383 | 12 | 500 | 3000-6000 | 80 | 1/25/100 | 5m |
| ΣΥΝΔΥΑΖΟΝΤΑΙ ΜΕ / COMBINED WITH: | | | 145-72930 / 145-72931 / 145-72932 | | | | > 216 ΣΕΛΙΔΑ / PAGE |

RGB COB 5m 10W 24V

Chip/m 480

| Code | Barcode | Watt | Amperage mA | Kelvin | Lm/Watt | Packing | MOQ |
|----------------------------------|---------------|------|---|--------|---------|----------|---------------------|
| 145-72029 | 5207227241413 | 12 | 500 | RGB | - | 1/25/100 | 5m, 8,90 |
| ΣΥΝΔΥΑΖΟΝΤΑΙ ΜΕ / COMBINED WITH: | | | 145-72940 / 145-72941 / 145-72942 / 145-72943 | | | | > 216 ΣΕΛΙΔΑ / PAGE |

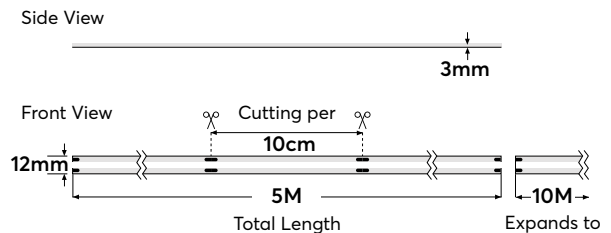

RGBW COB 5m 12W 24V

lm/CHIP 9-9,5
 25.000h
 IP44

Volt 24V • LED Type COB • Chip Brand Sanan
 Start Time 0,5 sec • Operating Temperature 0°C / +40°C
 Material Χαλκός - Πλαστικό / Copper - Plastic

Chip/m 640
 CRI Ra >80
 BEAM ANGLE 180°
 DIMMABLE
 3 YEARS WARRANTY

| Code | Barcode | Watt | Amperage mA | Kelvin | Lm/Watt | Packing | MOQ |
|----------------------------------|---------------|------|---|-----------|---------|----------|---------------------|
| 145-72030 | 5207227241444 | 12 | 625 | RGBW-6000 | 95 | 1/25/100 | 5m |
| 145-72031 | 5207227241475 | 12 | 625 | RGBW-4000 | 90 | 1/25/100 | 5m |
| 145-72032 | 5207227241505 | 12 | 625 | RGBW-3000 | 75 | 1/25/100 | 5m |
| ΣΥΝΔΥΑΖΟΝΤΑΙ ΜΕ / COMBINED WITH: | | | 145-72950 / 145-72951 / 145-72952 / 145-72953 | | | | > 217 ΣΕΛΙΔΑ / PAGE |

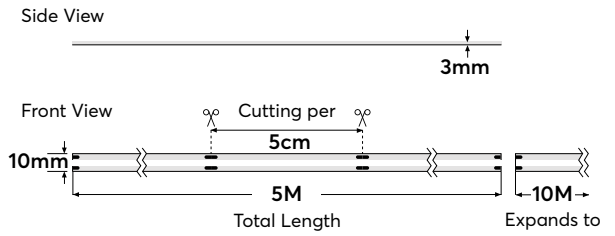

RGB CCT COB 5m 16W 24V



Im/CHIP 9-9,5 25.000h IP44 CE F PRO SERIES

Volt 24V • LED Type COB • Chip Brand Sanan
 Start Time 0,5 sec • Operating Temperature 0°C / +40°C
 Material Χαλκός - Πλαστικό / Copper - Plastic

Chip/m 640 CRI Ra >80 BEAM ANGLE 180° DIMMABLE 3 YEARS WARRANTY

| Code | Barcode | Watt | Amperage mA | Kelvin | Lm/Watt | Packing | MOQ |
|-----------|---------------|------|-------------|---------|---------|----------|-----|
| 145-72033 | 5207227437366 | 16 | 667 | RGB CCT | 100 | 1/25/100 | 5m |

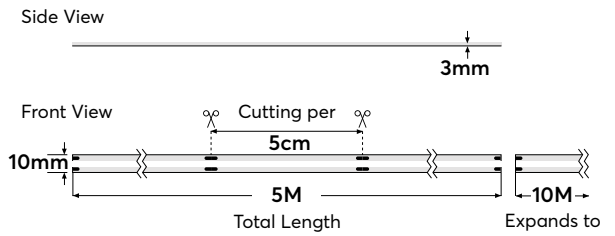

RGB Pixel COB 5m 12W 24V

Im/CHIP 9-9,5 25.000h IP44 CE PRO SERIES

Volt 24V • LED Type COB • Chip Brand Sanan
 Start Time 0,5 sec • Operating Temperature 0°C / +40°C
 Material Χαλκός - Πλαστικό / Copper - Plastic

Chip/m 540 CRI Ra >80 BEAM ANGLE 180° DIMMABLE 3 YEARS WARRANTY

| Code | Barcode | Watt | Amperage mA | Kelvin | Lm/Watt | Packing | MOQ |
|-----------|---------------|------|-------------|-----------|---------|----------|-----|
| 145-72500 | 5207227241536 | 12 | 500 | RGB PIXEL | - | 1/25/100 | 5m |

ΣΥΝΔΥΑΖΟΝΤΑΙ ΜΕ / COMBINED WITH: 145-72940 / 145-72941 / 145-72942 / 145-72943 > 216 ΣΕΛΙΔΑ / PAGE

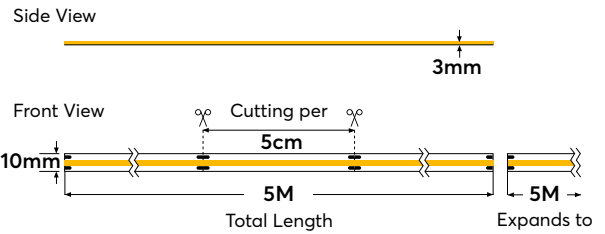

COB 5m 16W 24V



Volt 24V • LED Type COB • Chip Brand Sanan
 Start Time 0,5 sec • Operating Temperature 0°C / +40°C
 Material Χαλκός - Πλαστικό / Copper - Plastic

| | | | | |
|---------------|------------------|--------------------|----------|------------------------|
| Chip/m 480 | CRI Ra >90 | BEAM ANGLE 180° | DIMMABLE | 3 YEARS WARRANTY |
|---------------|------------------|--------------------|----------|------------------------|

| Code | Barcode | Watt | Amperage mA | Kelvin | Lm/Watt | Packing | MOQ |
|------------|---------------|------|-------------|--------|---------|----------|-----|
| 145-72050 | 5207227437182 | 16 | 667 | 6500 | 100 | 1/25/100 | 5m |
| 145-72051 | 5207227437212 | 16 | 667 | 4000 | 93 | 1/25/100 | 5m |
| 145-72052 | 5207227437243 | 16 | 667 | 3000 | 90 | 1/25/100 | 5m |
| 145-72053* | 5207227437274 | 16 | 667 | 2700 | 80 | 1/25/100 | 5m |

ΣΥΝΔΥΑΖΟΝΤΑΙ ΜΕ / COMBINED WITH: 145-72920 / 145-72921 / 145-72922 / 145-72923 / 145-72924 / 145-72925 > 215 ΣΕΛΙΔΑ / PAGE

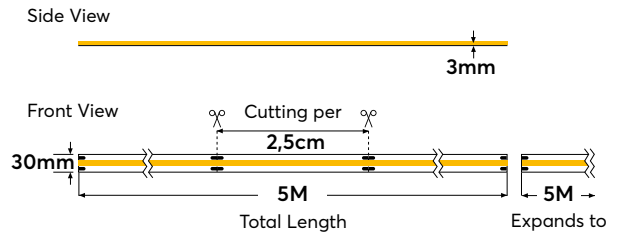

CCT COB 5m 40W 24V



Volt 24V • LED Type COB • Chip Brand Sanan
 Start Time 0,5 sec • Operating Temperature 0°C / +40°C
 Material Χαλκός - Πλαστικό / Copper - Plastic

| | | | | |
|----------------|------------------|--------------------|----------|------------------------|
| Chip/m 1600 | CRI Ra >80 | BEAM ANGLE 180° | DIMMABLE | 3 YEARS WARRANTY |
|----------------|------------------|--------------------|----------|------------------------|

| Code | Barcode | Watt | Amperage mA | Kelvin | Lm/Watt | Packing | MOQ |
|-----------|---------------|------|-------------|--------|---------|---------|-----|
| 145-72060 | 5207227437304 | 40 | 1667 | 6500 | 120 | 1/40 | 5m |
| 145-72061 | 5207227437328 | 40 | 1667 | 4000 | 115 | 1/40 | 5m |
| 145-72062 | 5207227437342 | 40 | 1667 | 3000 | 100 | 1/40 | 5m |
| 145-72063 | 5207227241567 | 40 | 1667 | 2700 | 90 | 1/40 | 5m |

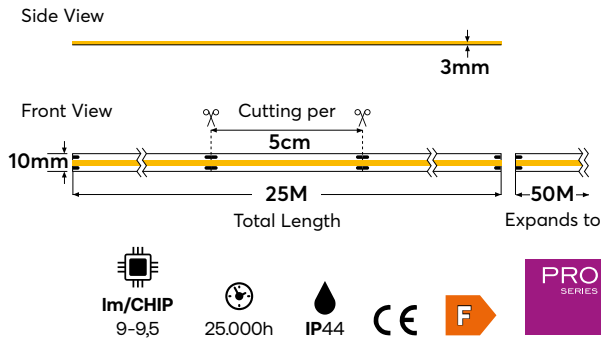

COB 25m 6W 48V

Volt 48V • LED Type COB • Chip Brand Sanan
 Start Time 0,5 sec • Operating Temperature 0°C / +40°C
 Material Χαλκός - Πλαστικό / Copper - Plastic

| | | | | |
|---------------|------------------|--------------------|----------|------------------------|
| Chip/m 504 | CRI Ra >80 | BEAM ANGLE 180° | DIMMABLE | 3 YEARS WARRANTY |
|---------------|------------------|--------------------|----------|------------------------|

| Code | Barcode | Watt | Amperage mA | Kelvin | Lm/Watt | Packing | MOQ |
|-----------|---------------|------|-------------|--------|---------|----------|-----|
| 145-72600 | 5207227241598 | 6 | 125 | 6500 | 105-110 | 1/25/100 | 25m |
| 145-72601 | 5207227241628 | 6 | 125 | 4000 | 95-100 | 1/25/100 | 25m |
| 145-72602 | 5207227241659 | 6 | 125 | 3000 | 90-95 | 1/25/100 | 25m |

ΣΥΝΔΥΑΖΟΝΤΑΙ ΜΕ / COMBINED WITH: 145-72920 / 145-72921 / 145-72922 / 145-72923 / 145-72924 / 145-72925 > 215 ΣΕΛΙΔΑ / PAGE

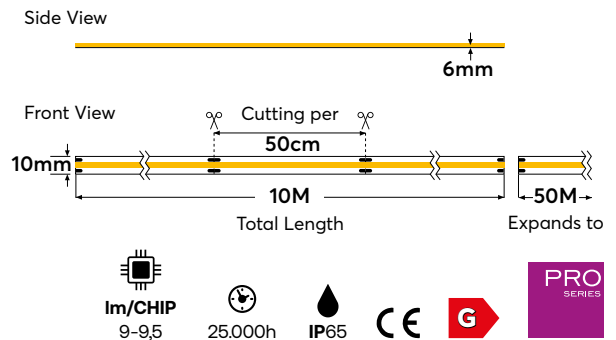

COB 10m 8W 220V - Waterproof IP65

Volt 220V • LED Type COB • Chip Brand Sanan
 Start Time 0,5 sec • Operating Temperature 0°C / +40°C
 Material Χαλκός - Πλαστικό / Copper - Plastic

| | | | | |
|---------------|------------------|--------------------|----------|------------------------|
| Chip/m 360 | CRI Ra >70 | BEAM ANGLE 180° | DIMMABLE | 3 YEARS WARRANTY |
|---------------|------------------|--------------------|----------|------------------------|

| Code | Barcode | Watt | Amperage mA | Kelvin | Lm/Watt | Packing | MOQ |
|-----------|---------------|------|-------------|--------|---------|---------|-----|
| 145-72700 | 5207227241680 | 8 | 36 | 6500 | 75-85 | 1/50 | 25m |
| 145-72701 | 5207227241703 | 8 | 36 | 4000 | 75-85 | 1/50 | 25m |
| 145-72702 | 5207227241727 | 8 | 36 | 3000 | 75-85 | 1/50 | 25m |

ΣΥΝΔΥΑΖΟΝΤΑΙ ΜΕ / COMBINED WITH: 145-72960 / 145-72961 / 145-72962 / 145-72963 > 217 ΣΕΛΙΔΑ / PAGE



LED

STRIP

SMD

LONGER LIFE

LED STRIP

TECHNOLOGY

SMD

Οι ταινίες τεχνολογίας LED SMD αποτελούνται από ένα ελαφρύ και μικρό τσιπ που περιβάλλεται από εποξική ρητίνη. Προσφέρουν υψηλή φωτεινότητα και έχουν χαμηλότερη κατανάλωση ενέργειας.

Δεν χρειάζονται συντήρηση λόγω της μεγάλης διάρκειας ζωής τους.

Συγκεκριμένα σε ιδανικές συνθήκες ρεύματος, τάσεως και θερμοκρασίας η διάρκεια ζωής τους μπορεί να φτάσει τις 100.000 ώρες

Οι ταινίες SMD μας παρέχουν μια ευρύτερη γκάμα χρωμάτων καθώς η θερμοκρασία χρώματος τους είναι πιο ρυθμιζόμενη. Με τα τρία βασικά χρώματα, το RGB, που χρησιμοποιούνται στο SMD, μπορούμε πρακτικά να εμφανίσουμε οποιοδήποτε χρώμα.

ΠΛΕΟΝΕΚΤΗΜΑΤΑ ΠΡΟΪΟΝΤΟΣ

- Εξοικονόμηση ενέργειας, λόγω χαμηλής κατανάλωσης
- Μειωμένο κόστος λόγω μεγάλης διάρκειας ζωής
- Χαμηλή εκπομπή θερμότητας
- Μεγάλη ευελιξία στη θερμοκρασία χρώματος

SMD LED technology strips consist of a light and small chip surrounded by epoxy resin. They offer high brightness and have lower energy consumption.

They do not need maintenance due to their long life. Specifically in ideal conditions of current, voltage and temperature n their lifespan can reach 100,000 hours.

Our SMD tapes provide a wider range of colors as the their color temperature is more adjustable. With the three basics colors, the RGB used in SMD can practically display any color.

PRODUCT ADVANTAGES

- Energy saving, due to low consumption
- Reduced costs due to long life
- Low heat emission
- Great flexibility in color temperature

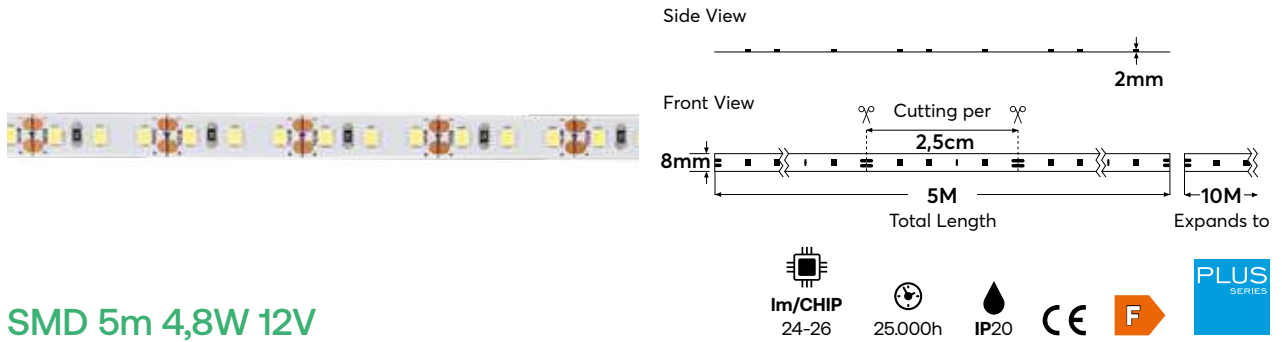

SMD 5m 4,8W 12V

Volt 12V • LED Type SMD2835 • Chip Brand Sanan
 Start Time 0,5 sec • Operating Temperature 0°C / +40°C
 Material Χαλκός - Πλαστικό / Copper - Plastic

| | | | | |
|---------------|------------------|--------------------|----------|------------------------|
| Chip/m 120 | CRI Ra >80 | BEAM ANGLE 120° | DIMMABLE | 2 YEARS WARRANTY |
|---------------|------------------|--------------------|----------|------------------------|

| Code | Barcode | Watt | Amperage mA | Kelvin | Lm/Watt | Packing | MOQ |
|-----------|---------------|------|-------------|--------|---------|----------|-----|
| 145-70102 | 5207227242274 | 4,8 | 400 | 6500 | 100-105 | 1/25/100 | 5m |
| 145-70103 | 5207227242304 | 4,8 | 400 | 4000 | 100-105 | 1/25/100 | 5m |
| 145-70104 | 5207227242335 | 4,8 | 400 | 3000 | 90-95 | 1/25/100 | 5m |
| 145-70105 | 5207227242366 | 4,8 | 400 | 2700 | 90-95 | 1/25/100 | 5m |

ΣΥΝΔΥΑΖΟΝΤΑΙ ΜΕ / COMBINED WITH: 145-73910 / 145-73911 / 145-73912 / 145-73913 / 145-73914 / 145-73915 > 218 ΣΕΛΙΔΑ / PAGE



ΦΩΤΙΣΜΟΣ - PROFESSIONAL LIGHTING

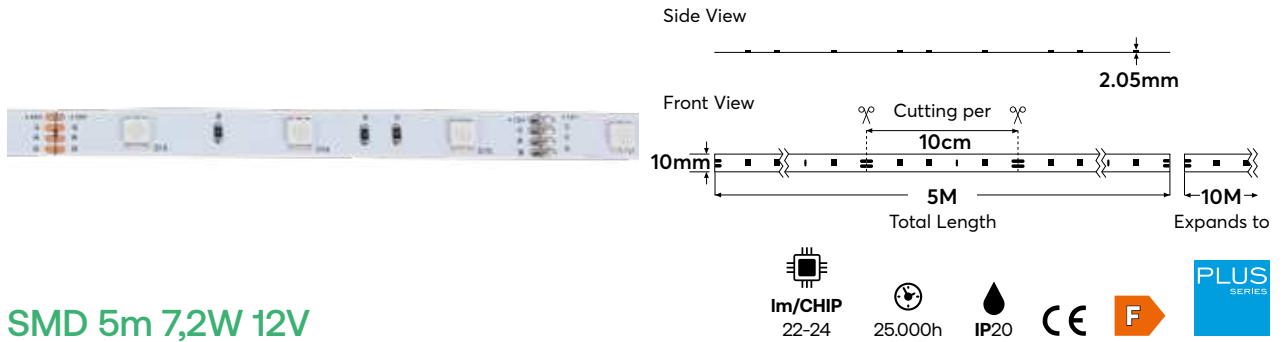

Side View

Front View

2.05mm

10mm

Cutting per 10cm

5M Total Length

Expands to 10M

lm/CHIP 22-24

25.000h

IP20

CE

F

PLUS SERIES

SMD 5m 7,2W 12V

Volt 12V · LED Type SMD5050 · Chip Brand Sanan
 Start Time 0,5 sec · Operating Temperature -20°C / +40°C
 Material Χαλκός - Πλαστικό / Copper - Plastic

| | | | | |
|--------------|------------------|--------------------|----------|------------------|
| Chip/m 30 | CRI Ra >80 | BEAM ANGLE 120° | DIMMABLE | 2 YEARS WARRANTY |
|--------------|------------------|--------------------|----------|------------------|

| Code | Barcode | Watt | Amperage mA | Kelvin | Lm/Watt | Packing | MOQ |
|-----------|---------------|------|-------------|--------|---------|----------|-----|
| 145-70120 | 5207227066528 | 7,2 | 600 | 6500 | 95 | 1/25/100 | 5m |
| 145-70121 | 5207227066559 | 7,2 | 600 | 4000 | 93 | 1/25/100 | 5m |
| 145-70122 | 5207227066580 | 7,2 | 600 | 3000 | 90 | 1/25/100 | 5m |
| 145-70123 | 5207227066610 | 7,2 | 600 | RGB | - | 1/25/100 | 5m |

ΣΥΝΔΥΑΖΟΝΤΑΙ ΜΕ / COMBINED WITH: 145-73930 / 145-73931 / 145-73932 / 145-73933 / 145-73934 / 145-73935 / 145-73936 > 219 ΣΕΛΙΔΑ / PAGE

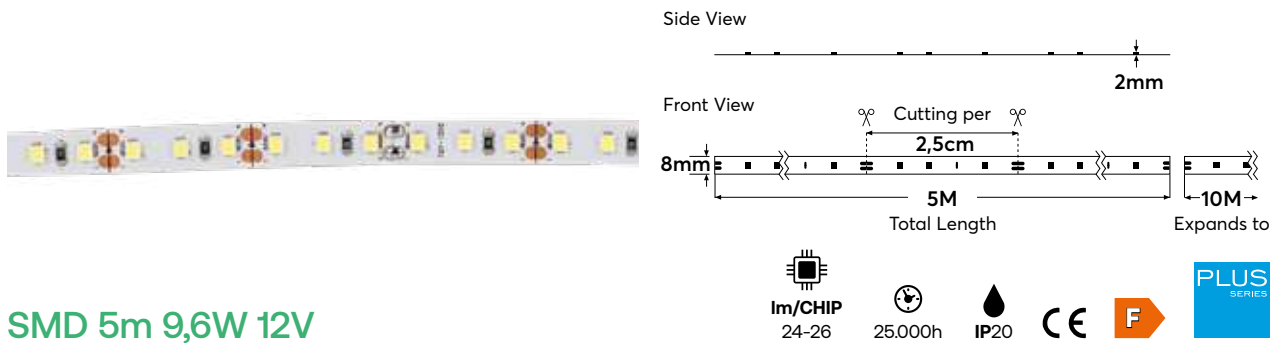

Side View

Front View

2mm

8mm

Cutting per 2,5cm

5M Total Length

Expands to 10M

lm/CHIP 24-26

25.000h

IP20

CE

F

PLUS SERIES

SMD 5m 9,6W 12V

Volt 12V · LED Type SMD2835 · Chip Brand Sanan
 Start Time 0,5 sec · Operating Temperature 0°C / +40°C
 Material Χαλκός - Πλαστικό / Copper - Plastic

| | | | | |
|---------------|------------------|--------------------|----------|------------------|
| Chip/m 120 | CRI Ra >80 | BEAM ANGLE 120° | DIMMABLE | 2 YEARS WARRANTY |
|---------------|------------------|--------------------|----------|------------------|

| Code | Barcode | Watt | Amperage mA | Kelvin | Lm/Watt | Packing | MOQ |
|-----------|---------------|------|-------------|--------|---------|----------|-----|
| 145-70125 | 5207227215728 | 9,6 | 800 | 6500 | 100-105 | 1/25/100 | 5m |
| 145-70126 | 5207227215759 | 9,6 | 800 | 4000 | 100-105 | 1/25/100 | 5m |
| 145-70127 | 5207227215780 | 9,6 | 800 | 3000 | 90-95 | 1/25/100 | 5m |
| 145-70128 | 5207227244339 | 9,6 | 800 | 2700 | 90-95 | 1/25/100 | 5m |

ΣΥΝΔΥΑΖΟΝΤΑΙ ΜΕ / COMBINED WITH: 145-73910 / 145-73911 / 145-73912 / 145-73913 / 145-73914 / 145-73915 > 218 ΣΕΛΙΔΑ / PAGE

Side View

Front View

1.40mm

8mm

5cm

5M

10M

Total Length

Expands to

lm/CHIP 24-26

25.000h

IP20

CE

F

PRO SERIES

SMD 5m 10W 12V

Volt 12V • LED Type SMD2835 • Chip Brand Sanan
 Start Time 0,5 sec • Operating Temperature -20°C / +40°C
 Material Χαλκός - Πλαστικό / Copper - Plastic

| | | | | |
|--------------|------------------|--------------------|----------|------------------------|
| Chip/m 60 | CRI Ra >80 | BEAM ANGLE 120° | DIMMABLE | 3 YEARS WARRANTY |
|--------------|------------------|--------------------|----------|------------------------|

| Code | Barcode | Watt | Amperage mA | Kelvin | Lm/Watt | Packing | MOQ |
|-----------|---------------|------|-------------|--------|---------|----------|-----|
| 145-70130 | 5207227079313 | 10 | 830 | 6500 | 105 | 1/25/100 | 5m |
| 145-70131 | 5207227079320 | 10 | 830 | 4000 | 103 | 1/25/100 | 5m |
| 145-70132 | 5207227079337 | 10 | 830 | 3000 | 100 | 1/25/100 | 5m |
| 145-70133 | 5207227121173 | 10 | 830 | RED | - | 1/25/100 | 5m |
| 145-70134 | 5207227121180 | 10 | 830 | GREEN | - | 1/25/100 | 5m |
| 145-70135 | 5207227121197 | 10 | 830 | BLUE | - | 1/25/100 | 5m |
| 145-70136 | 5207227121203 | 10 | 830 | YELLOW | - | 1/25/100 | 5m |

ΣΥΝΔΥΑΖΟΝΤΑΙ ΜΕ / COMBINED WITH: 145-73910 / 145-73911 / 145-73912 / 145-73913 / 145-73914 / 145-73915 > 219 ΣΕΛΙΔΑ / PAGE

Side View

Front View

2.05mm

10mm

5cm

5M

10M

Total Length

Expands to

25.000h

IP20

CE

PRO SERIES

SMD RGB 5m 10W 12V

Volt 12V • LED Type SMD2835 • Chip Brand Sanan
 Start Time 0,5 sec • Operating Temperature -20°C / +40°C
 Material Χαλκός - Πλαστικό / Copper - Plastic

| | | | |
|--------------|--------------------|----------|------------------------|
| Chip/m 60 | BEAM ANGLE 120° | DIMMABLE | 3 YEARS WARRANTY |
|--------------|--------------------|----------|------------------------|

| Code | Barcode | Watt | Amperage mA | Kelvin | Lm/Watt | Packing | MOQ |
|-----------|---------------|------|-------------|--------|---------|----------|-----|
| 145-70137 | 5207227079146 | 10 | 1200 | RGB | - | 1/25/100 | 5m |

ΣΥΝΔΥΑΖΟΝΤΑΙ ΜΕ / COMBINED WITH: 145-73930 / 145-73931 / 145-73932 / 145-73933 / 145-73934 / 145-73935 / 145-73936 > 219 ΣΕΛΙΔΑ / PAGE



Side View
1.40mm

Front View
Cutting per 5cm
8mm
30M Total Length
Expands to 10M

lm/CHIP 24-26
25.000h
IP20
CE
F
PRO SERIES

SMD 30m 10W 12V

Volt 12V · LED Type SMD2835 · Chip Brand Sanan
Start Time 0,5 sec · Operating Temperature -20°C / +40°C
Material Χαλκός - Πλαστικό / Copper - Plastic

Chip/m 60
CRI Ra >80
BEAM ANGLE 120°
DIMMABLE
3 YEARS WARRANTY

| Code | Barcode | Watt | Amperage mA | Kelvin | Lm/Watt | Packing | MOQ |
|-----------|---------------|------|-------------|--------|---------|---------|-----|
| 145-70140 | 5207227079672 | 10 | 830 | 6500 | 105 | 1/22 | 5m |
| 145-70141 | 5207227079696 | 10 | 830 | 4000 | 103 | 1/22 | 5m |
| 145-70142 | 5207227079719 | 10 | 830 | 3000 | 100 | 1/22 | 5m |

ΣΥΝΔΥΑΖΟΝΤΑΙ ΜΕ / COMBINED WITH: 145-73910 / 145-73911 / 145-73912 / 145-73913 / 145-73914 / 145-73915 > 218 ΣΕΛΙΔΑ / PAGE



Side View
2.05mm

Front View
Cutting per 5cm
10mm
30M Total Length
Expands to 10M

25.000h
IP20
CE
PRO SERIES

SMD RGB 30m 10W 12V

Volt 12V · LED Type SMD5050 · Chip Brand Sanan
Start Time 0,5 sec · Operating Temperature -20°C / +40°C
Material Χαλκός - Πλαστικό / Copper - Plastic

Chip/m 60
BEAM ANGLE 120°
DIMMABLE
3 YEARS WARRANTY

| Code | Barcode | Watt | Amperage mA | Kelvin | Lm/Watt | Packing | MOQ |
|-----------|---------------|------|-------------|--------|---------|---------|-----|
| 145-70143 | 5207227079733 | 10 | 1200 | RGB | - | 1/20 | 5m |

ΣΥΝΔΥΑΖΟΝΤΑΙ ΜΕ / COMBINED WITH: 145-73930 / 145-73931 / 145-73932 / 145-73933 / 145-73934 / 145-73935 / 145-73936 > 219 ΣΕΛΙΔΑ / PAGE

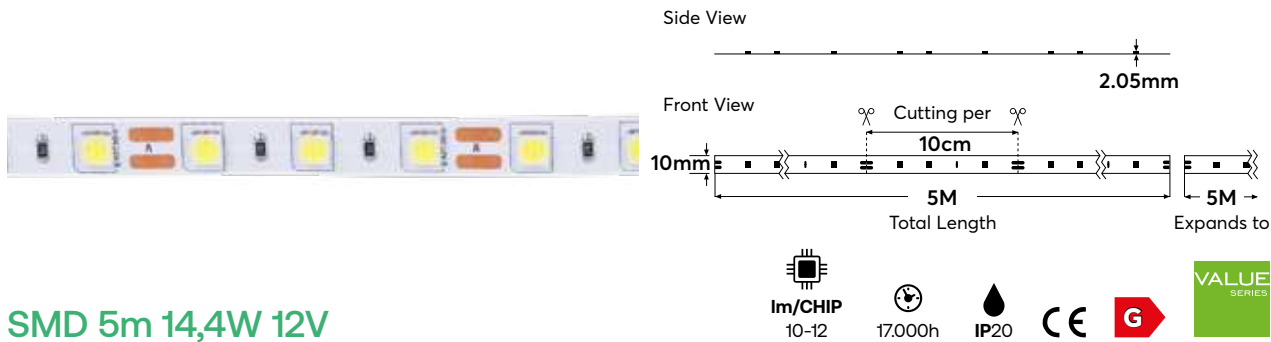

SMD 5m 14,4W 12V

Volt 12V · LED Type SMD5050 · Chip Brand Sanan
 Start Time 0,5 sec · Operating Temperature -20°C / +40°C
 Material Χαλκός - Πλαστικό / Copper - Plastic

| | | | | |
|--------------|------------------|--------------------|----------|------------------------|
| Chip/m 60 | CRI Ra >70 | BEAM ANGLE 120° | DIMMABLE | 1 YEARS WARRANTY |
|--------------|------------------|--------------------|----------|------------------------|

| Code | Barcode | Watt | Amperage mA | Kelvin | Lm/Watt | Packing | MOQ |
|-----------|---------------|------|-------------|--------|---------|----------|-----|
| 145-70150 | 5207227067372 | 14.4 | 1050 | 6500 | 65 | 1/25/100 | 5m |
| 145-70151 | 5207227067389 | 14.4 | 1050 | 4000 | 65 | 1/25/100 | 5m |
| 145-70152 | 5207227067396 | 14.4 | 1050 | 3000 | 65 | 1/25/100 | 5m |

ΣΥΝΔΥΑΖΟΝΤΑΙ ΜΕ / COMBINED WITH: 145-73920 / 145-73921 / 145-73922 / 145-73923 / 145-73924 / 145-73925 > 219 ΣΕΛΙΔΑ / PAGE

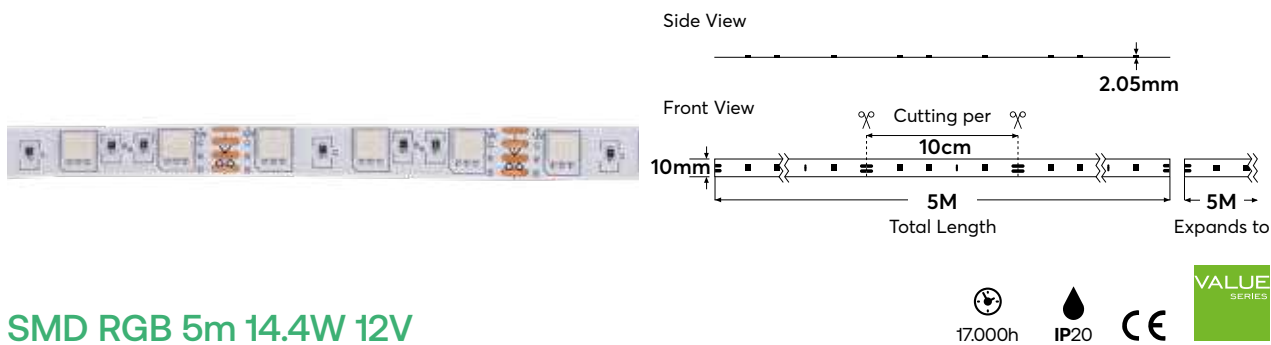

SMD RGB 5m 14.4W 12V

Volt 12V · LED Type SMD5050 · Chip Brand Sanan
 Start Time 0,5 sec · Operating Temperature -20°C / +40°C
 Material Χαλκός - Πλαστικό / Copper - Plastic

| | | | |
|--------------|--------------------|----------|------------------------|
| Chip/m 60 | BEAM ANGLE 120° | DIMMABLE | 1 YEARS WARRANTY |
|--------------|--------------------|----------|------------------------|

| Code | Barcode | Watt | Amperage mA | Kelvin | Lm/Watt | Packing | MOQ |
|-----------|---------------|------|-------------|--------|---------|----------|-----|
| 145-70157 | 5207227067402 | 14.4 | 1050 | RGB | - | 1/25/100 | 5m |

ΣΥΝΔΥΑΖΟΝΤΑΙ ΜΕ / COMBINED WITH: 145-73930 / 145-73931 / 145-73932 / 145-73933 / 145-73934 / 145-73935 / 145-73936 > 219 ΣΕΛΙΔΑ / PAGE

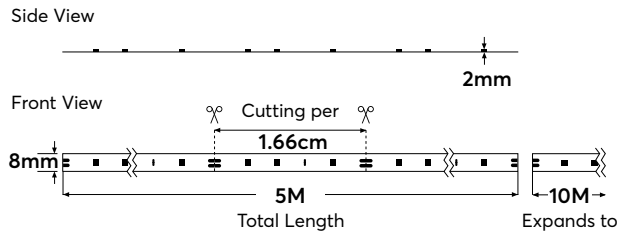

SMD 5m 14,4W 12V

Volt 12V • LED Type SMD2835 • Chip Brand Sanan
 Start Time 0,5 sec • Operating Temperature 0°C / +40°C
 Material Χαλκός - Πλαστικό / Copper - Plastic

Im/CHIP 24-26 25.000h IP20 CE F PRO SERIES

Chip/m 180 CRI Ra >80 BEAM ANGLE 120° DIMMABLE 3 YEARS WARRANTY

| Code | Barcode | Watt | Amperage mA | Kelvin | Lm/Watt | Packing | MOQ |
|-----------|---------------|------|-------------|--------|---------|----------|-----|
| 145-70170 | 5207227242397 | 14.4 | 1200 | 6500 | 100-105 | 1/25/100 | 5m |
| 145-70171 | 5207227242427 | 14.4 | 1200 | 4000 | 100-105 | 1/25/100 | 5m |
| 145-70172 | 5207227242458 | 14.4 | 1200 | 3000 | 90-95 | 1/25/100 | 5m |

ΣΥΝΔΥΑΖΟΝΤΑΙ ΜΕ / COMBINED WITH: 145-73910 / 145-73911 / 145-73912 / 145-73913 / 145-73914 / 145-73915 > 218 ΣΕΛΙΔΑ / PAGE

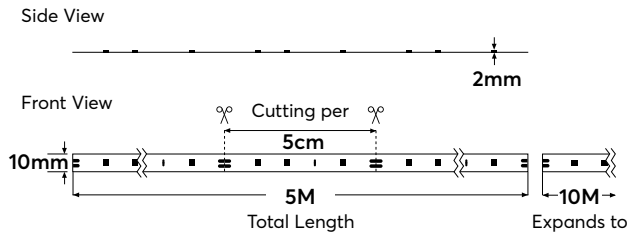

SMD RGB 5m 14.4W 12V

Volt 12V • LED Type SMD5050 • Chip Brand Sanan
 Start Time 0,5 sec • Operating Temperature 0°C / +40°C
 Material Χαλκός - Πλαστικό / Copper - Plastic

25.000h IP20 CE PRO SERIES

Chip/m 60 BEAM ANGLE 120° DIMMABLE 3 YEARS WARRANTY

| Code | Barcode | Watt | Amperage mA | Kelvin | Lm/Watt | Packing | MOQ |
|-----------|---------------|------|-------------|--------|---------|----------|-----|
| 145-70173 | 5207227242489 | 14.4 | 1200 | RGB | - | 1/25/100 | 5m |

ΣΥΝΔΥΑΖΟΝΤΑΙ ΜΕ / COMBINED WITH: 145-73930 / 145-73931 / 145-73932 / 145-73933 / 145-73934 / 145-73935 / 145-73936 > 219 ΣΕΛΙΔΑ / PAGE

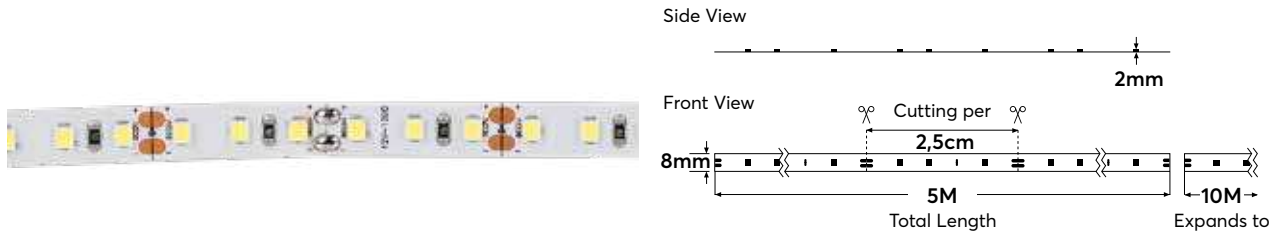

SMD 5m 4,8W 24V



Volt 24V • LED Type SMD2835 • Chip Brand Sanan
 Start Time 0,5 sec • Operating Temperature 0°C - +40°C
 Material Χαλκός - Πλαστικό / Copper - Plastic

| | | | | |
|---------------|------------------|--------------------|----------|------------------------|
| Chip/m 120 | CRI Ra >80 | BEAM ANGLE 120° | DIMMABLE | 2 YEARS WARRANTY |
|---------------|------------------|--------------------|----------|------------------------|

| Code | Barcode | Watt | Amperage mA | Kelvin | Lm/Watt | Packing | MOQ |
|-----------|---------------|------|-------------|--------|---------|----------|-----|
| 145-73310 | 5207227328916 | 4,8 | 400 | 6500 | 100-105 | 1/25/100 | 5m |
| 145-73311 | 5207227328923 | 4,8 | 400 | 4000 | 100-105 | 1/25/100 | 5m |
| 145-73312 | 5207227328930 | 4,8 | 400 | 3000 | 90-95 | 1/25/100 | 5m |
| 145-73313 | 5207227260629 | 4,8 | 400 | 2700 | 90-95 | 1/25/100 | 5m |

ΣΥΝΔΥΑΖΟΝΤΑΙ ΜΕ / COMBINED WITH: 145-73910 / 145-73911 / 145-73912 / 145-73913 / 145-73914 / 145-73915 > 218 ΣΕΛΙΔΑ / PAGE

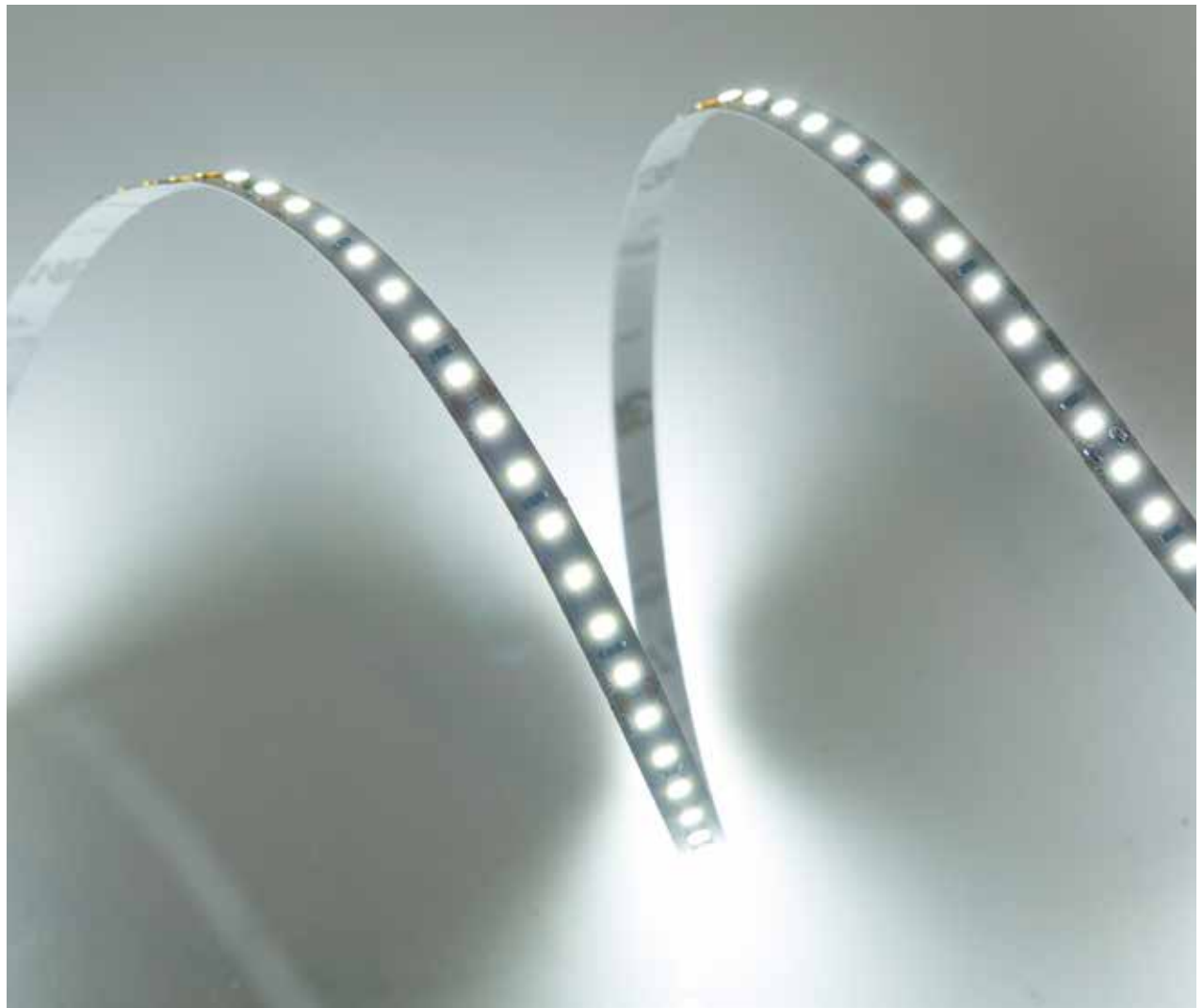

ΦΩΤΙΣΜΟΣ - PROFESSIONAL LIGHTING



Side View

Front View

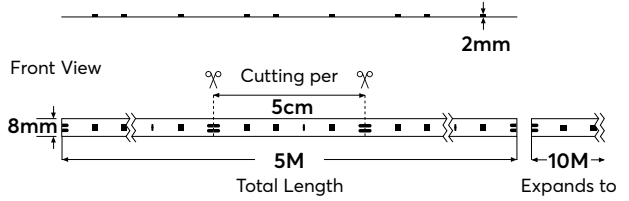

SMD 5m 8W 24V

Volt 24V • LED Type SMD2835 • Chip Brand Sanan
 Start Time 0,5 sec • Operating Temperature 0°C - +40°C
 Material Χαλκός - Πλαστικό / Copper - Plastic

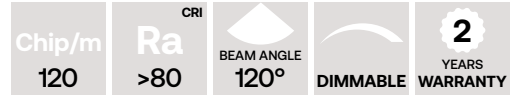

| Code | Barcode | Watt | Amperage mA | Kelvin | Lm/Watt | Packing | MOQ |
|-----------|---------------|------|-------------|--------|---------|----------|-----|
| 145-73300 | 5207227242830 | 8 | 333 | 6500 | 100-105 | 1/25/100 | 5m |
| 145-73301 | 5207227242861 | 8 | 333 | 4000 | 100-105 | 1/25/100 | 5m |
| 145-73302 | 5207227242892 | 8 | 333 | 3000 | 90-95 | 1/25/100 | 5m |

ΣΥΝΔΥΑΖΟΝΤΑΙ ΜΕ / COMBINED WITH: 145-73910 / 145-73911 / 145-73912 / 145-73913 / 145-73914 / 145-73915 > 218 ΣΕΛΙΔΑ / PAGE



Side View

Front View

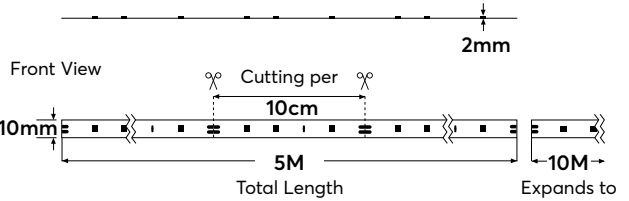

SMD RGB 5m 8W 24V

Volt 24V • LED Type SMD5050 • Chip Brand Sanan
 Start Time 0,5 sec • Operating Temperature 0°C - +40°C
 Material Χαλκός - Πλαστικό / Copper - Plastic

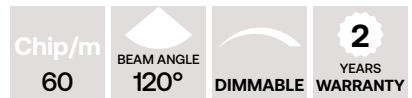

| Code | Barcode | Watt | Amperage mA | Kelvin | Lm/Watt | Packing | MOQ |
|-----------|---------------|------|-------------|--------|---------|----------|-----|
| 145-73305 | 5207227242922 | 8 | 333 | RGB | - | 1/25/100 | 5m |

ΣΥΝΔΥΑΖΟΝΤΑΙ ΜΕ / COMBINED WITH: 145-73930 / 145-73931 / 145-73932 / 145-73933 / 145-73934 / 145-73935 / 145-73936 > 219 ΣΕΛΙΔΑ / PAGE

SMD 5m 9,6W 24V

Volt 24V • LED Type SMD2835 • Chip Brand Sanan
 Start Time 0,5 sec • Operating Temperature -20°C - +40°C
 Material Χαλκός - Πλαστικό / Copper - Plastic

| | | | | |
|---------------|------------------|--------------------|----------|------------------------|
| Chip/m 120 | CRI Ra >80 | BEAM ANGLE 120° | DIMMABLE | 3 YEARS WARRANTY |
|---------------|------------------|--------------------|----------|------------------------|

| Code | Barcode | Watt | Amperage mA | Kelvin | Lm/Watt | Packing | MOQ |
|-----------|---------------|------|-------------|--------|---------|----------|-----|
| 145-70230 | 5207227067037 | 9.6 | 600 | 6500 | 115 | 1/25/100 | 5m |
| 145-70231 | 5207227067068 | 9.6 | 600 | 4000 | 105 | 1/25/100 | 5m |
| 145-70232 | 5207227067099 | 9.6 | 600 | 3000 | 95 | 1/25/100 | 5m |
| 145-70233 | 5207227159671 | 9.6 | 600 | 2700 | 86 | 1/100 | 5m |

ΣΥΝΔΥΑΖΟΝΤΑΙ ΜΕ / COMBINED WITH: 145-73910 / 145-73911 / 145-73912 / 145-73913 / 145-73914 / 145-73915 > 218 ΣΕΛΙΔΑ / PAGE

SMD 5m 9,6W 24V CRI95

Volt 24V • LED Type SMD2835 • Chip Brand Sanan
 Start Time 0,5 sec • Operating Temperature 0°C - +40°C
 Material Χαλκός - Πλαστικό / Copper - Plastic

| | | | | |
|---------------|------------------|--------------------|----------|------------------------|
| Chip/m 120 | CRI Ra >95 | BEAM ANGLE 120° | DIMMABLE | 3 YEARS WARRANTY |
|---------------|------------------|--------------------|----------|------------------------|

| Code | Barcode | Watt | Amperage mA | Kelvin | Lm/Watt | Packing | MOQ |
|-----------|---------------|------|-------------|--------|---------|----------|-----|
| 145-73330 | 5207227244513 | 9.6 | 400 | 6500 | 80-85 | 1/25/100 | 5m |
| 145-73331 | 5207227244544 | 9.6 | 400 | 5000 | 75-80 | 1/25/100 | 5m |
| 145-73332 | 5207227244575 | 9.6 | 400 | 4000 | 70-75 | 1/25/100 | 5m |
| 145-73333 | 5207227244605 | 9.6 | 400 | 3000 | 70-75 | 1/25/100 | 5m |
| 145-73334 | 5207227244636 | 9.6 | 400 | 2700 | 70-75 | 1/25/100 | 5m |

ΣΥΝΔΥΑΖΟΝΤΑΙ ΜΕ / COMBINED WITH: 145-73910 / 145-73911 / 145-73912 / 145-73913 / 145-73914 / 145-73915 > 218 ΣΕΛΙΔΑ / PAGE

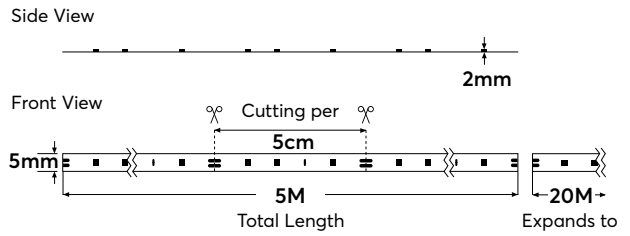

SMD 5m 10W 24V Mini

Volt 24V • LED Type SMD2835 • Chip Brand Sanan
 Start Time 0,5 sec • Operating Temperature 0°C - +40°C
 Material Χαλκός - Πλαστικό / Copper - Plastic

lm/CHIP 24-26 25.000h IP20 CE F PRO SERIES

Chip/m 120 CRI Ra >80 BEAM ANGLE 120° DIMMABLE 3 YEARS WARRANTY

| Code | Barcode | Watt | Amperage mA | Kelvin | Lm/Watt | Packing | MOQ |
|-----------|---------------|------|-------------|--------|---------|----------|-----|
| 145-73350 | 5207227242953 | 10 | 416 | 6500 | 100-105 | 1/25/100 | 5m |
| 145-73351 | 5207227242984 | 10 | 416 | 4000 | 100-105 | 1/25/100 | 5m |
| 145-73352 | 5207227243011 | 10 | 416 | 3000 | 90-95 | 1/25/100 | 5m |
| 145-73353 | 5207227243042 | 10 | 416 | 2700 | 90-95 | 1/25/100 | 5m |

ΣΥΝΔΥΑΖΟΝΤΑΙ ΜΕ / COMBINED WITH: 145-73900 / 145-73901 / 145-73902 / 145-73903 > 218 ΣΕΛΙΔΑ / PAGE

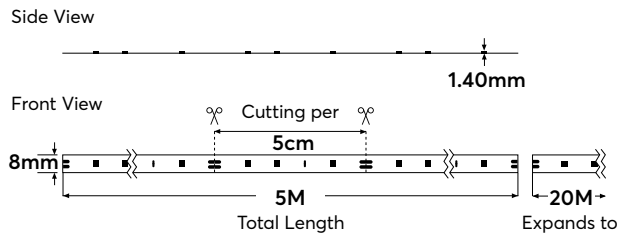

SMD 5m 10W 24V Flexible

Volt 24V • LED Type SMD2835 • Chip Brand Sanan
 Start Time 0,5 sec • Operating Temperature -20°C - +40°C
 Material Χαλκός - Πλαστικό / Copper - Plastic

lm/CHIP 24-26 25.000h IP20 CE F PRO SERIES

Chip/m 60 CRI Ra >80 BEAM ANGLE 120° DIMMABLE 3 YEARS WARRANTY

| Code | Barcode | Watt | Amperage mA | Kelvin | Lm/Watt | Packing | MOQ |
|-----------|---------------|------|-------------|--------|---------|----------|-----|
| 145-70235 | 5207227066641 | 10 | 410 | 6500 | 105 | 1/5/10 | 5m |
| 145-70236 | 5207227066672 | 10 | 410 | 4000 | 103 | 1/5/10 | 5m |
| 145-70237 | 5207227066702 | 10 | 410 | 3000 | 100 | 1/25/100 | 5m |

ΣΥΝΔΥΑΖΟΝΤΑΙ ΜΕ / COMBINED WITH: 145-73910 / 145-73911 / 145-73912 / 145-73913 / 145-73914 / 145-73915 > 218 ΣΕΛΙΔΑ / PAGE



Side View
2.05mm

Front View
8mm
Cutting per 10*/5**cm
5M Total Length
Expands to 20M

Im/CHIP 24-26
25.000h
IP20
CE
F
PRO SERIES

SMD 5m 10W 24V

Volt 24V • LED Type SMD2835 • Chip Brand Sanan
Start Time 0,5 sec • Operating Temperature -20°C - +40°C
Material Χαλκός - Πλαστικό / Copper - Plastic

Chip/m 60
CRI Ra >80
BEAM ANGLE 120°
DIMMABLE
3 YEARS WARRANTY

| Code | Barcode | Watt | Amperage mA | Kelvin | Lm/Watt | Packing | MOQ |
|-------------|---------------|------|-------------|--------|---------|----------|-----|
| 145-70240* | 5207227085628 | 10 | 410 | 6500 | 105 | 1/25/100 | 5m |
| 145-70241* | 5207227085659 | 10 | 410 | 4000 | 103 | 1/25/100 | 5m |
| 145-70242* | 5207227085680 | 10 | 410 | 3000 | 100 | 1/25/100 | 5m |
| 145-70248** | 5207227159718 | 10 | 410 | 2700 | 100 | 1/25/100 | 5m |

ΣΥΝΔΥΑΖΟΝΤΑΙ ΜΕ / COMBINED WITH: 145-73910 / 145-73911 / 145-73912 / 145-73913 / 145-73914 / 145-73915 > 218 ΣΕΛΙΔΑ / PAGE



Side View
2.05mm

Front View
10mm
Cutting per 10cm
5M Total Length
Expands to 20M

25.000h
IP20
CE
PRO SERIES

SMD RGB 5m 10W 24V

Volt 24V • LED Type SMD5050 • Chip Brand Sanan
Start Time 0,5 sec • Operating Temperature -20°C - +40°C
Material Χαλκός - Πλαστικό / Copper - Plastic

Chip/m 60
BEAM ANGLE 120°
DIMMABLE
3 YEARS WARRANTY

| Code | Barcode | Watt | Amperage mA | Kelvin | Lm/Watt | Packing | MOQ |
|-----------|---------------|------|-------------|--------|---------|----------|-----|
| 145-70243 | 5207227085710 | 10 | 1200 | RGB | - | 1/25/100 | 5m |

ΣΥΝΔΥΑΖΟΝΤΑΙ ΜΕ / COMBINED WITH: 145-73930 / 145-73931 / 145-73932 / 145-73933 / 145-73934 / 145-73935 / 145-73936 > 219 ΣΕΛΙΔΑ / PAGE

Side View

Front View

2.05mm

12mm

Cutting per 10cm

5M Total Length

Expands to 20M

Im/CHIP 10-12

25.000h

IP20

CE

F

PRO SERIES

SMD RGBW 5m 16W 24V

Volt 24V • LED Type SMD5050 • Chip Brand Sanan
 Start Time 0,5 sec • Operating Temperature -20°C - +40°C
 Material Χαλκός - Πλαστικό / Copper - Plastic

| | | | | |
|--------------|------------------|--------------------|----------|------------------------|
| Chip/m 60 | CRI Ra >80 | BEAM ANGLE 120° | DIMMABLE | 3 YEARS WARRANTY |
|--------------|------------------|--------------------|----------|------------------------|

| Code | Barcode | Watt | Amperage mA | Kelvin | Lm/Watt | Packing | MOQ |
|-----------|---------------|------|-------------|------------|---------|----------|-----|
| 145-70247 | 5207227246227 | 16 | 1200 | RGBW-6500 | 40 | 1/25/100 | 5m |
| 145-70244 | 5207227067150 | 16 | 1200 | RGBW-4000 | 36 | 1/25/100 | 5m |
| 145-70245 | 5207227085741 | 16 | 1200 | RGBWW-3000 | 31 | 1/25/100 | 5m |

ΣΥΝΔΥΑΖΟΝΤΑΙ ΜΕ / COMBINED WITH: 145-73940 / 145-73941 / 145-73942 / 145-73943 / 145-73944 / 145-73945 / 145-73946 > 220 ΣΕΛΙΔΑ / PAGE

Side View

Front View

2.05mm

12mm

Cutting per 5cm

5M Total Length

Expands to 20M

Im/CHIP 10-12

25.000h

IP20

CE

F

PRO SERIES

SMD RGBCCT 5m 10W 24V

Volt 24V • LED Type SMD5050 • Chip Brand Sanan
 Start Time 0,5 sec • Operating Temperature -20°C - +40°C
 Material Χαλκός - Πλαστικό / Copper - Plastic

| | | | | |
|--------------|------------------|--------------------|----------|------------------------|
| Chip/m 60 | CRI Ra >80 | BEAM ANGLE 120° | DIMMABLE | 3 YEARS WARRANTY |
|--------------|------------------|--------------------|----------|------------------------|

| Code | Barcode | Watt | Amperage mA | Kelvin | Lm/Watt | Packing | MOQ |
|-----------|---------------|------|-------------|--------|---------|----------|-----|
| 145-70246 | 5207227085741 | 10 | 1200 | RGBCCT | 64 | 1/25/100 | 5m |

ΣΥΝΔΥΑΖΟΝΤΑΙ ΜΕ / COMBINED WITH: 145-73940 / 145-73941 / 145-73942 / 145-73943 / 145-73944 / 145-73945 / 145-73946 > 220 ΣΕΛΙΔΑ / PAGE

Side View

Front View

3mm

8mm

5cm Cutting per

5M Total Length

5M Expands to

Im/CHIP 26-28

25.000h

IP20

CE

D

PRO SERIES

SMD 5m 12W 24V

Volt 24V • LED Type SMD2835 • Chip Brand Sanan
 Start Time 0,5 sec • Operating Temperature 0°C - +40°C
 Material Χαλκός - Πλαστικό / Copper - Plastic

| | | | | |
|---------------|------------------|--------------------|----------|------------------------|
| Chip/m 140 | CRI Ra >80 | BEAM ANGLE 120° | DIMMABLE | 3 YEARS WARRANTY |
|---------------|------------------|--------------------|----------|------------------------|

| Code | Barcode | Watt | Amperage mA | Kelvin | Lm/Watt | Packing | MOQ |
|-----------|---------------|------|-------------|--------|---------|----------|-----|
| 145-73410 | 5207227470646 | 12 | 500 | 6500 | 135 | 1/25/100 | 5m |
| 145-73411 | 5207227470653 | 12 | 500 | 4000 | 130 | 1/25/100 | 5m |
| 145-73412 | 5207227470660 | 12 | 500 | 3000 | 125 | 1/25/100 | 5m |
| 145-73413 | 5207227470677 | 12 | 500 | 2700 | 120 | 1/25/100 | 5m |

ΣΥΝΔΥΑΖΟΝΤΑΙ ΜΕ / COMBINED WITH: 145-73910 / 145-73911 / 145-73912 / 145-73913 / 145-73914 / 145-73915 > 218 ΣΕΛΙΔΑ / PAGE

Side View

Front View

3mm

10mm

5cm Cutting per

5M Total Length

5M Expands to

NEW

HIGH Lumen

Im/CHIP 30-32

25.000h

IP20

CE

D

PRO SERIES

SMD 5m 12W 24V

Volt 24V • LED Type SMD2835 • Chip Brand Sanan
 Start Time 0,5 sec • Operating Temperature 0°C - +40°C
 Material Χαλκός - Πλαστικό / Copper - Plastic

| | | | | |
|---------------|------------------|--------------------|----------|------------------------|
| Chip/m 128 | CRI Ra >80 | BEAM ANGLE 120° | DIMMABLE | 3 YEARS WARRANTY |
|---------------|------------------|--------------------|----------|------------------------|

| Code | Barcode | Watt | Amperage mA | Kelvin | Lm/Watt | Packing | MOQ |
|-----------|---------------|------|-------------|--------|---------|----------|-----|
| 145-73430 | 5207227437670 | 12 | 500 | 6500 | 160 | 1/25/100 | 5m |
| 145-73431 | 5207227437700 | 12 | 500 | 4000 | 155 | 1/25/100 | 5m |
| 145-73432 | 5207227437731 | 12 | 500 | 3000 | 145 | 1/25/100 | 5m |
| 145-73433 | 5207227447853 | 12 | 500 | 2700 | 135 | 1/25/100 | 5m |

ΣΥΝΔΥΑΖΟΝΤΑΙ ΜΕ / COMBINED WITH: 145-73920 / 145-73921 / 145-73922 / 145-73923 / 145-73924 / 145-73925 > 219 ΣΕΛΙΔΑ / PAGE

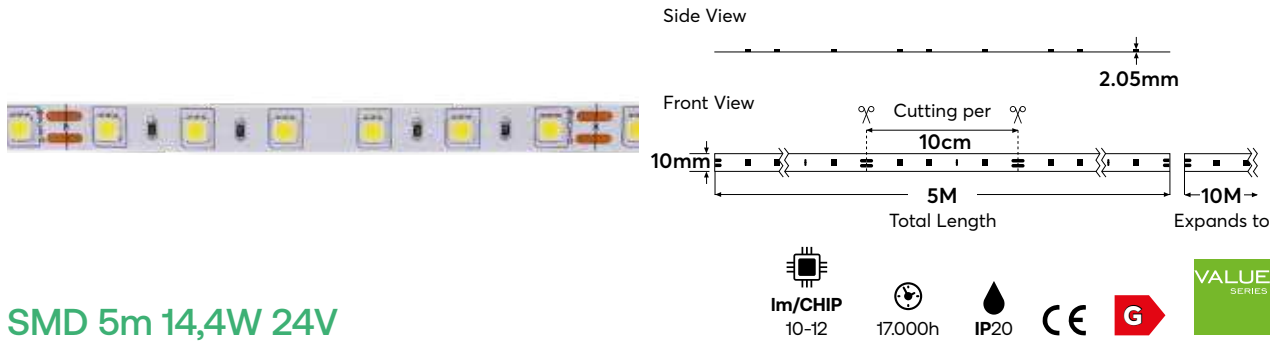

SMD 5m 14,4W 24V

Volt 24V • LED Type SMD5050 • Chip Brand Sanan
 Start Time 0,5 sec • Operating Temperature -20°C - +40°C
 Material Χαλκός - Πλαστικό / Copper - Plastic

| | | | | |
|--------------|------------------|--------------------|----------|------------------------|
| Chip/m 60 | CRI Ra >70 | BEAM ANGLE 120° | DIMMABLE | 2 YEARS WARRANTY |
|--------------|------------------|--------------------|----------|------------------------|

| Code | Barcode | Watt | Amperage mA | Kelvin | Lm/Watt | Packing | MOQ |
|-----------|---------------|------|-------------|--------|---------|----------|-----|
| 145-70250 | 5207227066733 | 14.4 | 600 | 6500 | 65 | 1/25/100 | 5m |
| 145-70251 | 5207227066764 | 14.4 | 600 | 4000 | 65 | 1/25/100 | 5m |
| 145-70252 | 5207227066795 | 14.4 | 600 | 3000 | 65 | 1/25/100 | 5m |

ΣΥΝΔΥΑΖΟΝΤΑΙ ΜΕ / COMBINED WITH: 145-73920 / 145-73921 / 145-73922 / 145-73923 / 145-73924 / 145-73925 > 219 ΣΕΛΙΔΑ / PAGE

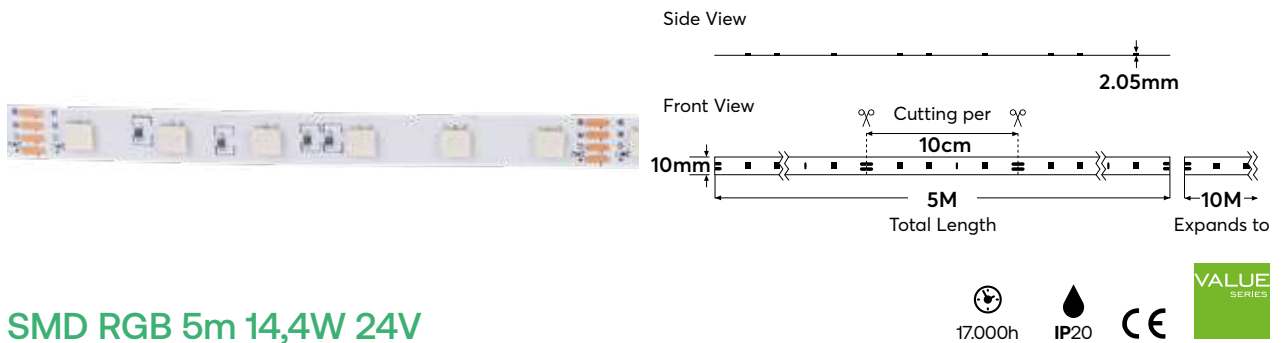

SMD RGB 5m 14,4W 24V

Volt 24V • LED Type SMD5050 • Chip Brand Sanan
 Start Time 0,5 sec • Operating Temperature -20°C - +40°C
 Material Χαλκός - Πλαστικό / Copper - Plastic

| | | | |
|--------------|--------------------|----------|------------------------|
| Chip/m 60 | BEAM ANGLE 120° | DIMMABLE | 2 YEARS WARRANTY |
|--------------|--------------------|----------|------------------------|

| Code | Barcode | Watt | Amperage mA | Kelvin | Lm/Watt | Packing | MOQ |
|-----------|---------------|------|-------------|--------|---------|----------|-----|
| 145-70253 | 5207227066825 | 14.4 | 600 | RGB | - | 1/25/100 | 5m |

ΣΥΝΔΥΑΖΟΝΤΑΙ ΜΕ / COMBINED WITH: 145-73930 / 145-73931 / 145-73932 / 145-73933 / 145-73934 / 145-73935 / 145-73936 > 219 ΣΕΛΙΔΑ / PAGE

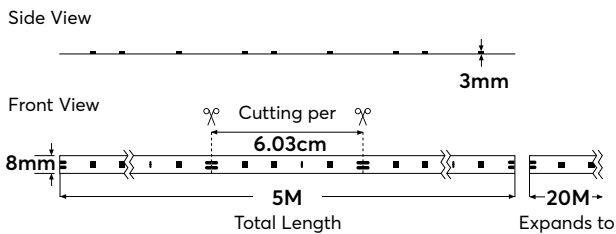

SMD 5m 14,4W 24V

Volt 24V • LED Type SMD2835 • Chip Brand Sanan
 Start Time 0,5 sec • Operating Temperature 0°C - +40°C
 Material Χαλκός - Πλαστικό / Copper - Plastic

Im/CHIP 24-26 25.000h IP20 CE F PRO SERIES

Chip/m 120 CRI Ra >80 BEAM ANGLE 120° DIMMABLE 3 YEARS WARRANTY

| Code | Barcode | Watt | Amperage mA | Kelvin | Lm/Watt | Packing | MOQ |
|-----------|---------------|------|-------------|--------|---------|----------|-----|
| 145-73400 | 5207227244667 | 14.4 | 600 | 6500 | 100-105 | 1/25/100 | 5m |
| 145-73401 | 5207227244698 | 14.4 | 600 | 4000 | 100-105 | 1/25/100 | 5m |
| 145-73402 | 5207227244728 | 14.4 | 600 | 3000 | 90-95 | 1/25/100 | 5m |
| 145-73403 | 5207227244759 | 14.4 | 600 | 2700 | 90-95 | 1/25/100 | 5m |

ΣΥΝΔΥΑΖΟΝΤΑΙ ΜΕ / COMBINED WITH: 145-73910 / 145-73911 / 145-73912 / 145-73913 / 145-73914 / 145-73915 > 218 ΣΕΛΙΔΑ / PAGE

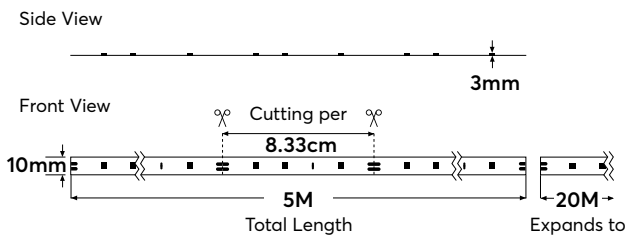

SMD RGB 5m 17W 24V

Volt 24V • LED Type SMD5050 • Chip Brand Sanan
 Start Time 0,5 sec • Operating Temperature 0°C - +40°C
 Material Χαλκός - Πλαστικό / Copper - Plastic

25.000h IP20 CE PRO SERIES

Chip/m 72 BEAM ANGLE 120° DIMMABLE 3 YEARS WARRANTY

| Code | Barcode | Watt | Amperage mA | Kelvin | Lm/Watt | Packing | MOQ |
|-----------|---------------|------|-------------|--------|---------|----------|-----|
| 145-73404 | 5207227244780 | 17 | 600 | RGB | - | 1/25/100 | 5m |

ΣΥΝΔΥΑΖΟΝΤΑΙ ΜΕ / COMBINED WITH: 145-73930 / 145-73931 / 145-73932 / 145-73933 / 145-73934 / 145-73935 / 145-73936 > 219 ΣΕΛΙΔΑ / PAGE

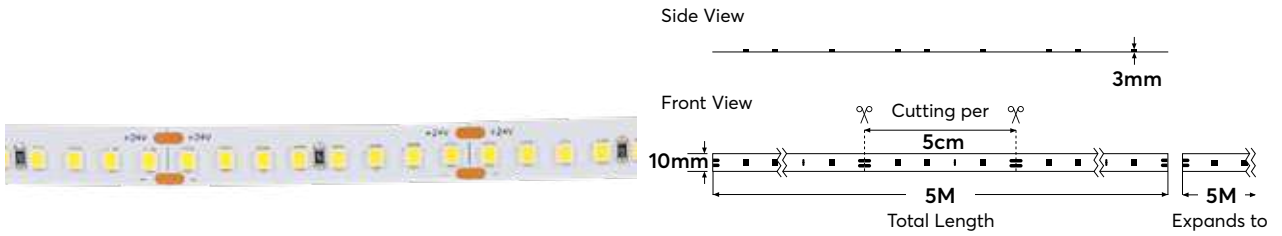

SMD 5m 14,4W 24V



Volt 24V • LED Type SMD2835 • Chip Brand Sanan
 Start Time 0,5 sec • Operating Temperature 0°C - +40°C
 Material Χαλκός - Πλαστικό / Copper - Plastic

| | | | | |
|---------------|------------------|--------------------|----------|------------------------|
| Chip/m 160 | CRI Ra >80 | BEAM ANGLE 120° | DIMMABLE | 3 YEARS WARRANTY |
|---------------|------------------|--------------------|----------|------------------------|

| Code | Barcode | Watt | Amperage mA | Kelvin | Lm/Watt | Packing | MOQ |
|-----------|---------------|------|-------------|--------|---------|----------|-----|
| 145-73420 | 5207227437557 | 14.4 | 600 | 6500 | 160 | 1/25/100 | 5m |
| 145-73421 | 5207227437588 | 14.4 | 600 | 4000 | 155 | 1/25/100 | 5m |
| 145-73422 | 5207227437618 | 14.4 | 600 | 3000 | 145 | 1/25/100 | 5m |
| 145-73423 | 5207227437649 | 14.4 | 600 | 2700 | 135 | 1/25/100 | 5m |

ΣΥΝΔΥΑΖΟΝΤΑΙ ΜΕ / COMBINED WITH: 145-73920 / 145-73921 / 145-73922 / 145-73923 / 145-73924 / 145-73925 > 219 ΣΕΛΙΔΑ / PAGE

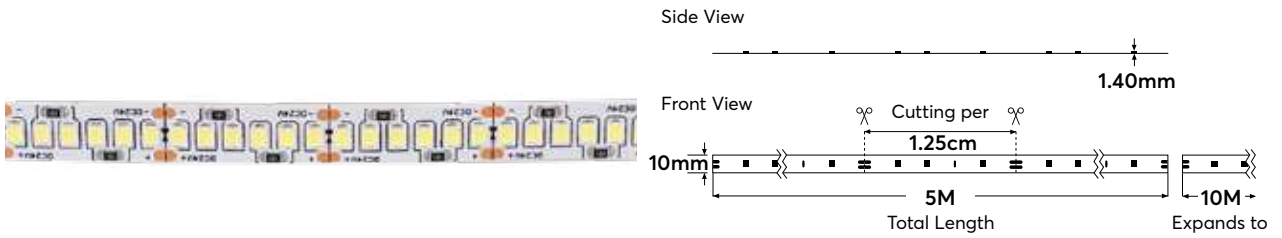

SMD 5m 14,4W 24V



Volt 24V • LED Type SMD2835 • Chip Brand Sanan
 Start Time 0,5 sec • Operating Temperature -20°C - +40°C
 Material Χαλκός - Πλαστικό / Copper - Plastic

| | | | | |
|---------------|------------------|--------------------|----------|------------------------|
| Chip/m 240 | CRI Ra >80 | BEAM ANGLE 120° | DIMMABLE | 2 YEARS WARRANTY |
|---------------|------------------|--------------------|----------|------------------------|

| Code | Barcode | Watt | Amperage mA | Kelvin | Lm/Watt | Packing | MOQ |
|-----------|---------------|------|-------------|--------|---------|----------|-----|
| 145-70275 | 5207227101113 | 16 | 750 | 6500 | 95 | 1/25/100 | 5m |
| 145-70276 | 5207227101144 | 16 | 750 | 4000 | 90 | 1/25/100 | 5m |
| 145-70277 | 5207227101175 | 16 | 750 | 3000 | 85 | 1/25/100 | 5m |
| 145-70278 | 5207227159817 | 16 | 750 | 2700 | 85 | 1/25/100 | 5m |

ΣΥΝΔΥΑΖΟΝΤΑΙ ΜΕ / COMBINED WITH: 145-73920 / 145-73921 / 145-73922 / 145-73923 / 145-73924 / 145-73925 > 219 ΣΕΛΙΔΑ / PAGE



Side View

Front View

10mm

3mm

Cutting per 10cm

5M Total Length

Expands to 30M

NEW

lm/CHIP 26-28

25.000h

IP20

CE

D

PRO SERIES

SMD 5m 10W 48V

Volt 48V • LED Type SMD2835 • Chip Brand Sanan
 Start Time 0,5 sec • Operating Temperature 0°C - +40°C
 Material Χαλκός - Πλαστικό / Copper - Plastic

Chip/m 140

CRI Ra >80

BEAM ANGLE 120°

DIMMABLE

3 YEARS WARRANTY

| Code | Barcode | Watt | Amperage mA | Kelvin | Lm/Watt | Packing | MOQ |
|-----------|---------------|------|-------------|--------|---------|----------|-----|
| 145-73360 | 5207227437403 | 10 | 208 | 6500 | 100 | 1/25/100 | 5m |
| 145-73361 | 5207227437434 | 10 | 208 | 4000 | 95 | 1/25/100 | 5m |
| 145-73362 | 5207227437465 | 10 | 208 | 3000 | 90 | 1/25/100 | 5m |
| 145-73363 | 5207227437496 | 10 | 208 | 2700 | 80 | 1/25/100 | 5m |

ΣΥΝΔΥΑΖΟΝΤΑΙ ΜΕ / COMBINED WITH: 145-73920 / 145-73921 / 145-73922 / 145-73923 / 145-73924 / 145-73925 > 219 ΣΕΛΙΔΑ / PAGE



Side View

Front View

10mm

3mm

Cutting per 16.7cm

5M Total Length

Expands to 30M

NEW

25.000h

IP20

CE

PRO SERIES

SMD RGB 5m 10W 48V

Volt 48V • LED Type SMD5050 • Chip Brand Sanan
 Start Time 0,5 sec • Operating Temperature 0°C - +40°C
 Material Χαλκός - Πλαστικό / Copper - Plastic

Chip/m 72

BEAM ANGLE 120°

DIMMABLE

3 YEARS WARRANTY

| Code | Barcode | Watt | Amperage mA | Kelvin | Lm/Watt | Packing | MOQ |
|-----------|---------------|------|-------------|--------|---------|----------|-----|
| 145-73364 | 5207227437526 | 10 | 208 | RGB | - | 1/25/100 | 5m |

ΣΥΝΔΥΑΖΟΝΤΑΙ ΜΕ / COMBINED WITH: 145-73930 / 145-73931 / 145-73932 / 145-73933 / 145-73934 / 145-73935 / 145-73936 > 219 ΣΕΛΙΔΑ / PAGE

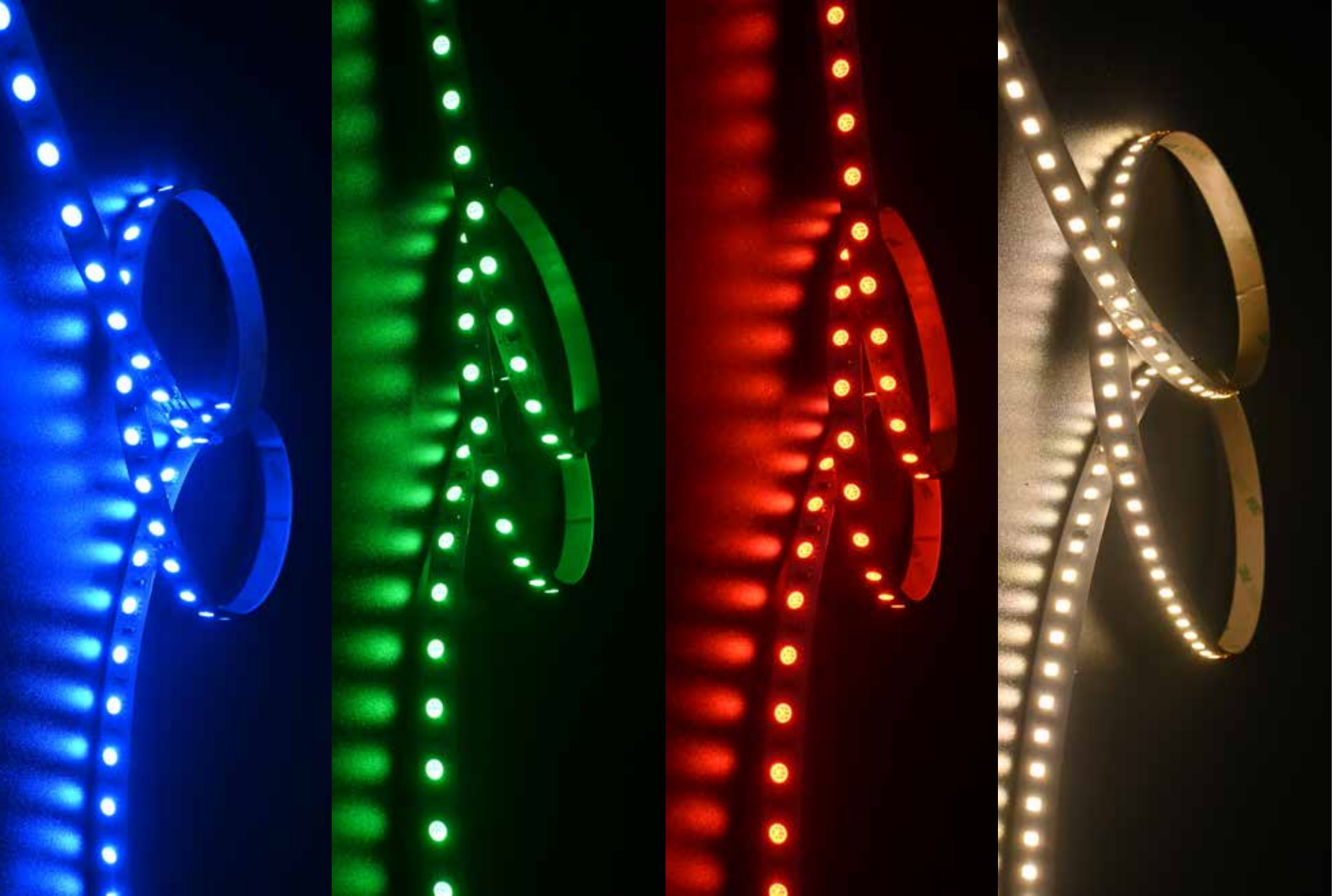



Side View

Front View

3mm

8mm

2,5cm Cutting per

5M Total Length

10M Expands to

lm/CHIP 24-26

25.000h

IP54

CE

F

PRO SERIES

SMD 5m 12W 12V

Volt 12V · LED Type SMD2835 · Chip Brand Sanan
 Start Time 0,5 sec · Operating Temperature 0°C - +40°C
 Material Χαλκός - Πλαστικό / Copper - Plastic

| | | | | |
|---------------|------------------|--------------------|----------|------------------------|
| Chip/m 120 | CRI Ra >80 | BEAM ANGLE 120° | DIMMABLE | 3 YEARS WARRANTY |
|---------------|------------------|--------------------|----------|------------------------|

| Code | Barcode | Watt | Amperage mA | Kelvin | Lm/Watt | Packing | MOQ |
|-----------|---------------|------|-------------|--------|---------|---------|-----|
| 145-70320 | 5207227244810 | 12 | 1000 | 6500 | 100-105 | 1/25/50 | 5m |
| 145-70321 | 5207227242519 | 12 | 1000 | 4000 | 100-105 | 1/25/50 | 5m |
| 145-70322 | 5207227242540 | 12 | 1000 | 3000 | 90-95 | 1/25/50 | 5m |
| 145-70323 | 5207227244841 | 12 | 1000 | 2700 | 90-95 | 1/25/50 | 5m |

ΣΥΝΔΥΑΖΟΝΤΑΙ ΜΕ / COMBINED WITH: 145-73910 / 145-73911 / 145-73912 / 145-73913 / 145-73914 / 145-73915 > 218 ΣΕΛΙΔΑ / PAGE



Side View

Front View

3mm

10mm

5cm Cutting per

5M Total Length

10M Expands to

25.000h

IP54

CE

PRO SERIES

SMD RGB 5m 12W 12V

Volt 12V · LED Type SMD5050 · Chip Brand Sanan
 Start Time 0,5 sec · Operating Temperature 0°C - +40°C
 Material Χαλκός - Πλαστικό / Copper - Plastic

| | | | |
|--------------|--------------------|----------|------------------------|
| Chip/m 60 | BEAM ANGLE 120° | DIMMABLE | 3 YEARS WARRANTY |
|--------------|--------------------|----------|------------------------|

| Code | Barcode | Watt | Amperage mA | Kelvin | Lm/Watt | Packing | MOQ |
|-----------|---------------|------|-------------|--------|---------|---------|-----|
| 145-70324 | 5207227244872 | 12 | 1000 | RGB | - | 1/25/50 | 5m |

ΣΥΝΔΥΑΖΟΝΤΑΙ ΜΕ / COMBINED WITH: 145-73930 / 145-73931 / 145-73932 / 145-73933 / 145-73934 / 145-73935 / 145-73936 > 219 ΣΕΛΙΔΑ / PAGE

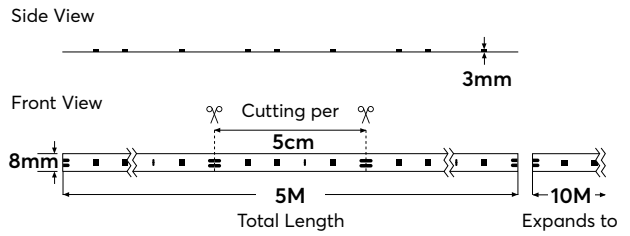

SMD 5m 12W 24V

Volt 24V • LED Type SMD2835 • Chip Brand Sanan
 Start Time 0,5 sec • Operating Temperature 0°C - +40°C
 Material Χαλκός - Πλαστικό / Copper - Plastic



| | | | | |
|---------------|------------------|--------------------|----------|------------------------|
| Chip/m 120 | CRI Ra >80 | BEAM ANGLE 120° | DIMMABLE | 3 YEARS WARRANTY |
|---------------|------------------|--------------------|----------|------------------------|

| Code | Barcode | Watt | Amperage mA | Kelvin | Lm/Watt | Packing | MOQ |
|-----------|---------------|------|-------------|--------|---------|---------|-----|
| 145-70360 | 5207227242571 | 12 | 500 | 6500 | 100-105 | 1/25/50 | 5m |
| 145-70361 | 5207227244902 | 12 | 500 | 4000 | 100-105 | 1/25/50 | 5m |
| 145-70362 | 5207227244933 | 12 | 500 | 3000 | 90-95 | 1/25/50 | 5m |
| 145-70363 | 5207227244964 | 12 | 500 | 2700 | 90-95 | 1/25/50 | 5m |

ΣΥΝΔΥΑΖΟΝΤΑΙ ΜΕ / COMBINED WITH: 145-73910 / 145-73911 / 145-73912 / 145-73913 / 145-73914 / 145-73915 > 218 ΣΕΛΙΔΑ / PAGE

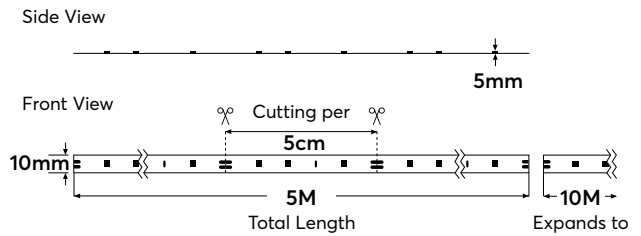

SMD RGB 5m 12W 24V

Volt 24V • LED Type SMD2835 • Chip Brand Sanan
 Start Time 0,5 sec • Operating Temperature 0°C - +40°C
 Material Χαλκός - Πλαστικό / Copper - Plastic



| | | | |
|--------------|--------------------|----------|------------------------|
| Chip/m 60 | BEAM ANGLE 120° | DIMMABLE | 3 YEARS WARRANTY |
|--------------|--------------------|----------|------------------------|

| Code | Barcode | Watt | Amperage mA | Kelvin | Lm/Watt | Packing | MOQ |
|-----------|---------------|------|-------------|--------|---------|---------|-----|
| 145-70364 | 5207227244995 | 12 | 500 | RGB | - | 1/25/50 | 5m |

ΣΥΝΔΥΑΖΟΝΤΑΙ ΜΕ / COMBINED WITH: 145-73930 / 145-73931 / 145-73932 / 145-73933 / 145-73934 / 145-73935 / 145-73936 > 219 ΣΕΛΙΔΑ / PAGE



Side View

Front View

11mm

5mm

Cutting per 5cm

5M Total Length

Expands to 10M

Im/CHIP 24-26

25.000h

IP68

CE

F

PRO SERIES

SMD 5m 10W 24V

Volt 24V • LED Type SMD2835 • Chip Brand Sanan
 Start Time 0,5 sec • Operating Temperature -20°C - +40°C
 Material Χαλκός - Πλαστικό / Copper - Plastic

| | | | | |
|--------------|------------------|--------------------|----------|------------------------|
| Chip/m 60 | CRI Ra >80 | BEAM ANGLE 120° | DIMMABLE | 3 YEARS WARRANTY |
|--------------|------------------|--------------------|----------|------------------------|

| Code | Barcode | Watt | Amperage mA | Kelvin | Lm/Watt | Packing | MOQ |
|-----------|---------------|------|-------------|--------|---------|---------|-----|
| 145-70410 | 5207227079399 | 10 | 830 | 6500 | 105 | 1/20/40 | 5m |
| 145-70411 | 5207227079580 | 10 | 830 | 4000 | 103 | 1/20/40 | 5m |
| 145-70412 | 5207227079610 | 10 | 830 | 3000 | 100 | 1/20/40 | 5m |
| 145-70418 | 5207227159923 | 10 | 830 | 2700 | 100 | 1/50 | 5m |



Side View

Front View

11mm

*5mm / **2.80mm

Cutting per 5cm

5M Total Length

Expands to 10M

Im/CHIP 10-12

25.000h

IP68

CE

F

PRO SERIES

SMD RGB 5m 10W 24V

Volt 24V • LED Type SMD5050 • Chip Brand Sanan
 Start Time 0,5 sec • Operating Temperature -20°C - +40°C
 Material Χαλκός - Πλαστικό / Copper - Plastic

| | | | | |
|--------------|------------------|--------------------|----------|------------------------|
| Chip/m 60 | CRI Ra >80 | BEAM ANGLE 120° | DIMMABLE | 3 YEARS WARRANTY |
|--------------|------------------|--------------------|----------|------------------------|

| Code | Barcode | Watt | Amperage mA | Kelvin | Lm/Watt | Packing | MOQ |
|--------------|---------------|------|-------------|--------|---------|----------|-----|
| 145-70413 * | 5207227084669 | 10 | 1200 | RGB | - | 1/20/40 | 5m |
| 145-70414 ** | 5207227084690 | 10 | 1200 | RGBW | 80 | 1/20/160 | 5m |
| 145-70415 ** | 5207227123481 | 10 | 1200 | RGBWW | 75 | 1/50 | 5m |

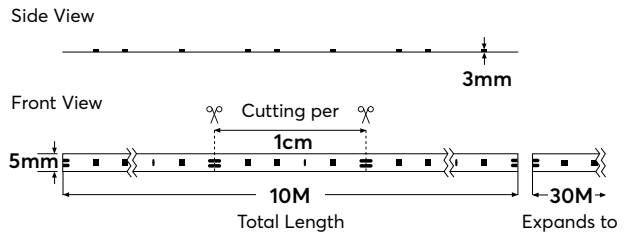

SMD 10m 7,5W 220V Mini



DRIVER FREE



Volt 220V · LED Type SMD2025 · Chip Brand Sanan
 Start Time 0,5 sec · Operating Temperature 0°C - +40°C
 Material Χαλκός - Πλαστικό / Copper - Plastic

| | | | | |
|---------------|------------------|--------------------|----------|------------------------|
| Chip/m 180 | CRI Ra >80 | BEAM ANGLE 120° | DIMMABLE | 3 YEARS WARRANTY |
|---------------|------------------|--------------------|----------|------------------------|

| Code | Barcode | Watt | Amperage mA | Kelvin | Lm/Watt | Packing | MOQ | |
|----------------------------------|---------------|---|-------------|--------|---------|---------------------|-----|--|
| 145-70440 | 5207227436826 | 7.5 | 3400 | 6500 | 85 | 1/25/100 | 10m | |
| 145-70441 | 5207227436857 | 7.5 | 3400 | 4000 | 82 | 1/25/100 | 10m | |
| 145-70442 | 5207227436888 | 7.5 | 3400 | 3000 | 77 | 1/25/100 | 10m | |
| ΣΥΝΔΥΑΖΟΝΤΑΙ ΜΕ / COMBINED WITH: | | 145-72900 / 145-72901 / 145-72902 / 145-72903 | | | | > 214 ΣΕΛΙΔΑ / PAGE | | |

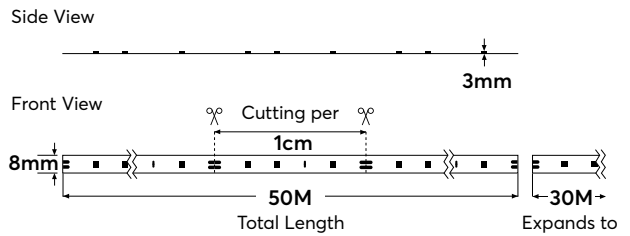

SMD 50m 8W 220V



DRIVER FREE



Volt 220V · LED Type SMD2835 · Chip Brand Sanan
 Start Time 0,5 sec · Operating Temperature 0°C - +40°C
 Material Χαλκός - Πλαστικό / Copper - Plastic

| | | | | |
|---------------|------------------|--------------------|----------|------------------------|
| Chip/m 120 | CRI Ra >80 | BEAM ANGLE 120° | DIMMABLE | 3 YEARS WARRANTY |
|---------------|------------------|--------------------|----------|------------------------|

| Code | Barcode | Watt | Amperage mA | Kelvin | Lm/Watt | Packing | MOQ | |
|----------------------------------|---------------|-----------------------------------|-------------|--------|---------|---------------------|-----|--|
| 145-70445 | 5207227436901 | 8 | 3600 | 6500 | 100 | 1/5/10 | 50m | |
| 145-70446 | 5207227436918 | 8 | 3600 | 4000 | 90 | 1/5/10 | 50m | |
| 145-70447 | 5207227436925 | 8 | 3600 | 3000 | 80 | 1/5/10 | 50m | |
| ΣΥΝΔΥΑΖΟΝΤΑΙ ΜΕ / COMBINED WITH: | | 145-73970 / 145-73971 / 145-73972 | | | | > 220 ΣΕΛΙΔΑ / PAGE | | |

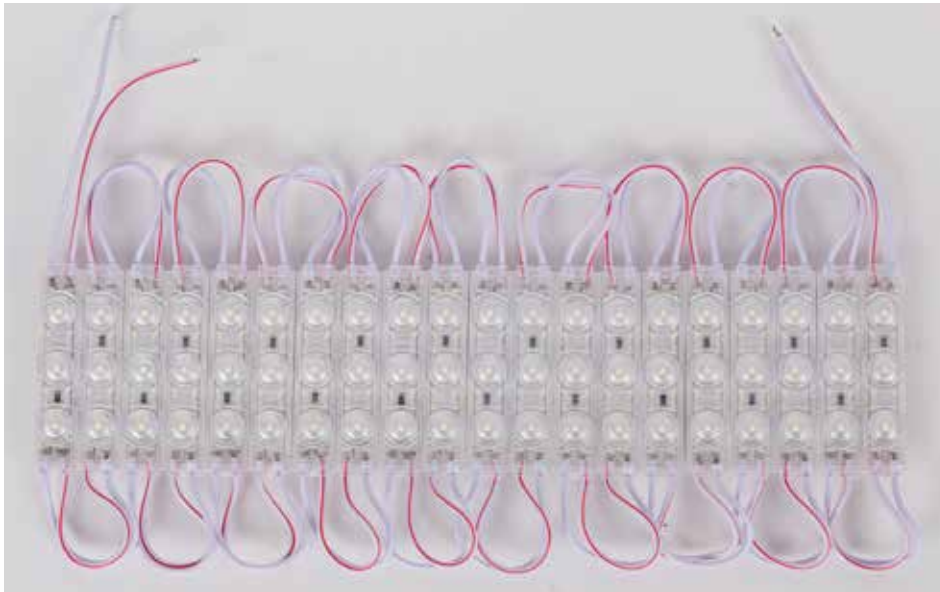

Modules SMD LED 1,2W - 12V (20pcs)

lm/CHIP
24-26

25.000h

IP65

CE

F

PRO
SERIES

Volt 12V • LED Type SMD2835 • Chip Brand Samsung
Start Time 0,5 sec • Operating Temperature 0°C - +40°C
Material Χαλκός - Πλαστικό / Copper - Plastic

| | | | | |
|-----------------|------------------|--------------------|----------|------------------------|
| Chip / pcs 3 | CRI Ra >80 | BEAM ANGLE 120° | DIMMABLE | 3 YEARS WARRANTY |
|-----------------|------------------|--------------------|----------|------------------------|

| Code | Barcode | Watt | Amperage mA | Kelvin | Lm/Watt | Packing | MOQ |
|-----------|----------------|------|----------------|-----------------|---------|------------|-------|
| 145-70470 | 5207227242601 | 1.2 | 100 | 6500 | 105 | 1/200/2000 | 20PCS |
| 145-70471 | 5207227242632 | 1.2 | 100 | 4000 | 105 | 1/200/2000 | 20PCS |
| 145-70472 | 52072272426241 | 1.2 | 100 | 3000 | 105 | 1/200/2000 | 20PCS |
| 145-70473 | 52072272426272 | 1.2 | 100 | KOKKINO / RED | 105 | 1/200/2000 | 20PCS |
| 145-70474 | 52072272426663 | 1.2 | 100 | ΠΡΑΣΙΝΟ / GREEN | 105 | 1/200/2000 | 20PCS |
| 145-70475 | 52072272426302 | 1.2 | 100 | ΜΠΛΕ / BLUE | 105 | 1/200/2000 | 20PCS |

Side View

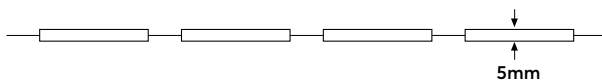

Front View

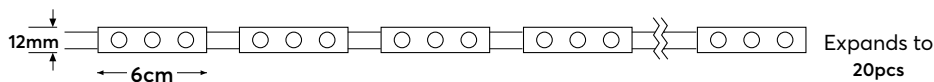

LED STRIP ACCESSORIES

ΕΞΑΡΤΗΜΑΤΑ ΤΑΙΝΙΩΝ

Για την ολοκληρωμένη εμπειρία των προϊόντων μας LED, διαθέτουμε μια μεγάλη γκάμα αξεσουάρ ταινιών φωτισμού LED. Η επιλογή των αξεσουάρ προϊόντων μας θα βελτιώσει την εγκατάσταση φωτισμού, επιτρέποντάς σας να συνδέσετε τα προϊόντα LED σας, να επεκτείνετε την καλωδίωση, να ασφαλίσετε τα άκρα των καλωδίων και πολλά άλλα. Τα αξεσουάρ μας για τις ταινίες LED διαθέτουν όλα όσα χρειάζεστε για εύκολη και ασφαλή εγκατάσταση. Αυτό περιλαμβάνει στηρίγματα, ενώσεις, συνδέσμους, γωνίες, T, τροφοδοσίες.

For the complete experience of our LED products, we have a wide range of LED strips accessories. The choice of our accessories will improve your lighting installation, allowing you to connect your LED products, expand wiring, secure cable ends and more. Our LED strip accessories have everything you need for easy and safe installation. Our catalogue includes props, joints, connectors, angles, tees, feeds.

NEON FLEX LED STRIP

Neon Flex Light LED Strip



CODE 145-73950
BARCODE 5207227249617
PRODUCT TYPE ΦΙΣ ΤΡΟΦΟΔΟΣΙΑΣ
 POWER PLUG CONNECTION
LxWxH [mm] 120 x 15 x 10
PACKING [MOQ] 10/500 [10]



145-73951
BARCODE 5207227249631
PRODUCT TYPE ΕΝΩΤΙΚΟ ΜΕ ΚΑΛΩΔΙΟ
 CONNECTION WITH CABLE
LxWxH [mm] 120 x 15 x 10
PACKING [MOQ] 10/500 [10]



145-73952
BARCODE 5207227249655
PRODUCT TYPE ΤΑΠΑ
 END CAP
LxWxH [mm] 50 x 6 x 10
PACKING [MOQ] 10/500 [10]



CODE 145-73953
BARCODE 5207227249679
PRODUCT TYPE ΚΛΙΠ
 FIX CLIP FOR INSTALL
LxWxH [mm] 50 x 6 x 10
PACKING [MOQ] 10/500 [10]



145-73954
BARCODE 5207227249693
PRODUCT TYPE ΚΛΙΚ (ΣΤΗΡΙΞΗ ΣΤΡΟΦΗΣ)
 CLICK (MOUNTING BRACKET)
LxWxH [mm] 12 x 8 x 10
PACKING [MOQ] 10/500 [10]

COB LED STRIP

COB LED Strip MINI - 5mm



CODE 145-72900
BARCODE 5207227248405
PRODUCT TYPE ΦΙΣ ΤΡΟΦΟΔΟΣΙΑΣ
 POWER PLUG CONNECTION
LxWxH [mm] 170 x 7 x 5
PACKING [MOQ] 10/500 [10]



145-72901
BARCODE 5207227248429
PRODUCT TYPE ΕΝΩΤΙΚΟ
 CONNECTOR
LxWxH [mm] 17 x 7 x 5
PACKING [MOQ] 10/500 [10]



145-72902
BARCODE 5207227248443
PRODUCT TYPE ΕΝΩΤΙΚΟ ΜΕ ΚΑΛΩΔΙΟ
 CONNECTOR WITH CABLE
LxWxH [mm] 190 x 7 x 5
PACKING [MOQ] 10/500 [10]



CODE 145-72903
BARCODE 5207227248467
PRODUCT TYPE ΕΝΩΤΙΚΗ ΓΩΝΙΑ
 CORNER TYPE CONNECTOR
LxWxH [mm] 17 x 14 x 4,5
PACKING [MOQ] 10/500 [10]

COB LED Strip - 8mm

 -20 | +45 °C
 
 IP44
 

CODE 145-72910
BARCODE 5207227248504
PRODUCT TYPE ΦΙΣ ΤΡΟΦΟΔΟΣΙΑΣ
 POWER PLUG CONNECTION
LxWxH [mm] 170 x 10 x 5
PACKING [MOQ] 10/500 [10]



CODE 145-72911
BARCODE 5207227248528
PRODUCT TYPE ΕΝΩΤΙΚΟ
 CONNECTOR
LxWxH [mm] 17 x 10 x 5
PACKING [MOQ] 10/500 [10]



CODE 145-72912
BARCODE 5207227248542
PRODUCT TYPE ΕΝΩΤΙΚΟ ΜΕ ΚΑΛΩΔΙΟ
 CONNECTOR WITH CABLE
LxWxH [mm] 190 x 10 x 5
PACKING [MOQ] 10/500 [10]



CODE 145-72913
BARCODE 5207227248566
PRODUCT TYPE ΕΝΩΤΙΚΗ ΓΩΝΙΑ
 CORNER TYPE CONNECTOR
LxWxH [mm] 17 x 16 x 5
PACKING [MOQ] 10/500 [10]



CODE 145-72914
BARCODE 5207227248580
PRODUCT TYPE ΕΝΩΤΙΚΟ ΤΑΦ
 T TYPE CONNECTOR
LxWxH [mm] 45 x 28 x 5
PACKING [MOQ] 10/500 [10]



CODE 145-72915
BARCODE 5207227248603
PRODUCT TYPE ΕΝΩΤΙΚΟΣ ΣΤΑΥΡΟΣ
 CROSS TYPE CONNECTOR
LxWxH [mm] 44 x 44 x 5
PACKING [MOQ] 10/500 [10]

COB LED Strip - 10mm

 -20 | +45 °C
 
 IP44
 

CODE 145-72920
BARCODE 5207227248627
PRODUCT TYPE ΦΙΣ ΤΡΟΦΟΔΟΣΙΑΣ
 POWER PLUG CONNECTION
LxWxH [mm] 170 x 11 x 5
PACKING [MOQ] 10/500 [10]



CODE 145-72921
BARCODE 5207227248641
PRODUCT TYPE ΕΝΩΤΙΚΟ
 CONNECTOR
LxWxH [mm] 17 x 11 x 5
PACKING [MOQ] 10/500 [10]



CODE 145-72922
BARCODE 5207227248665
PRODUCT TYPE ΕΝΩΤΙΚΟ ΜΕ ΚΑΛΩΔΙΟ
 CONNECTOR WITH CABLE
LxWxH [mm] 190 x 11 x 5
PACKING [MOQ] 10/500 [10]



CODE 145-72923
BARCODE 5207227248689
PRODUCT TYPE ΕΝΩΤΙΚΗ ΓΩΝΙΑ
 CORNER TYPE CONNECTOR
LxWxH [mm] 17 x 30 x 5
PACKING [MOQ] 10/500 [10]



CODE 145-72924
BARCODE 5207227248702
PRODUCT TYPE ΕΝΩΤΙΚΟ ΤΑΦ
 T TYPE CONNECTOR
LxWxH [mm] 45 x 28 x 5
PACKING [MOQ] 10/500 [10]



CODE 145-72925
BARCODE 5207227248726
PRODUCT TYPE ΕΝΩΤΙΚΟΣ ΣΤΑΥΡΟΣ
 CROSS TYPE CONNECTOR
LxWxH [mm] 44 x 44 x 5
PACKING [MOQ] 10/500 [10]

COB CCT LED Strip - 10mm





| | | | |
|----------------------|--|----------------------|--|
| CODE | 145-72930 | 145-72931 | 145-72932 |
| BARCODE | 5207227248740 | 5207227248764 | 5207227248788 |
| PRODUCT TYPE | ΦΙΣ ΤΡΟΦΟΔΟΣΙΑΣ POWER PLUG CONNECTION | ΕΝΩΤΙΚΟ CONNECTOR | ΕΝΩΤΙΚΟ ΜΕ ΚΑΛΩΔΙΟ CONNECTOR WITH CABLE |
| LxWxH [mm] | 170 x 11 x 5 | 17 x 11 x 5 | 190 x 11 x 5 |
| PACKING [MOQ] | 10/500 [10] | 10/500 [10] | 10/500 [10] |

COB RGB LED Strip - 10mm





| | | | |
|----------------------|--|----------------------|--|
| CODE | 145-72940 | 145-72941 | 145-72942 |
| BARCODE | 5207227248832 | 5207227248856 | 5207227248870 |
| PRODUCT TYPE | ΦΙΣ ΤΡΟΦΟΔΟΣΙΑΣ POWER PLUG CONNECTION | ΕΝΩΤΙΚΟ CONNECTOR | ΕΝΩΤΙΚΟ ΜΕ ΚΑΛΩΔΙΟ CONNECTOR WITH CABLE |
| LxWxH [mm] | 170 x 11 x 5 | 17 x 11 x 5 | 190 x 11 x 5 |
| PACKING [MOQ] | 10/500 [10] | 10/500 [10] | 10/500 [10] |



| | |
|----------------------|--|
| CODE | 145-72943 |
| BARCODE | 5207227248894 |
| PRODUCT TYPE | ΕΝΩΤΙΚΗ ΓΩΝΙΑ CORNER TYPE CONNECTOR |
| LxWxH [mm] | 17 x 11 x 5 |
| PACKING [MOQ] | 10/500 [10] |

COB RGB LEDW Strip - 12mm



| | | | |
|----------------------|--|----------------------|--|
| CODE | 145-72950 | 145-72951 | 145-72952 |
| BARCODE | 5207227248931 | 5207227248948 | 5207227248955 |
| PRODUCT TYPE | ΦΙΣ ΤΡΟΦΟΔΟΣΙΑΣ POWER PLUG CONNECTION | ΕΝΩΤΙΚΟ CONNECTOR | ΕΝΩΤΙΚΟ ΜΕ ΚΑΛΩΔΙΟ CONNECTOR WITH CABLE |
| LxWxH [mm] | 110 x 13 x 5 | 13 x 10 x 5 | 120 x 13 x 5 |
| PACKING [MOQ] | 10/500 [10] | 10/500 [10] | 10/500 [10] |



| | |
|----------------------|--|
| CODE | 145-72953 |
| BARCODE | 5207227248962 |
| PRODUCT TYPE | ΕΝΩΤΙΚΗ ΓΩΝΙΑ CORNER TYPE CONNECTOR |
| LxWxH [mm] | 28 x 28 x 5 |
| PACKING [MOQ] | 10/500 [10] |

COB 220V LED Strip - 10mm



| | | |
|----------------------|--|------------------|
| CODE | 145-72960 | 145-72961 |
| BARCODE | 5207227273087 | 5207227273100 |
| PRODUCT TYPE | ΦΙΣ ΤΡΟΦΟΔΟΣΙΑΣ POWER PLUG CONNECTION | ΤΑΠΑ END CAP |
| LxWxH [mm] | 450 x 35 x 2 | 19 x 18 x 8 |
| PACKING [MOQ] | 10/500 [10] | 10/500 [10] |



| | | |
|----------------------|--------------------------|----------------------|
| CODE | 145-72962 | 145-72963 |
| BARCODE | 5207227273124 | 5207227363863 |
| PRODUCT TYPE | ΒΑΣΗ ΩΜΕΓΑ OMEGA BASE | ΕΝΩΤΙΚΟ CONNECTOR |
| LxWxH [mm] | 18 x 8 x 8 | 17 x 11 x 5 |
| PACKING [MOQ] | 10/500 [10] | 10/500 [10] |

SMD mini LED Strip - 5mm



| | | | |
|----------------------|--|----------------------|--|
| CODE | 145-73900 | 145-73901 | 145-73902 |
| BARCODE | 5207227248993 | 5207227249013 | 5207227249037 |
| PRODUCT TYPE | ΦΙΣ ΤΡΟΦΟΔΟΣΙΑΣ POWER PLUG CONNECTION | ΕΝΩΤΙΚΟ CONNECTOR | ΕΝΩΤΙΚΟ ΜΕ ΚΑΛΩΔΙΟ CONNECTOR WITH CABLE |
| L×W×H [mm] | 170 x 6 x 5 | 17 x 6 x 5 | 190 x 6 x 5 |
| PACKING [MOQ] | 10/500 [10] | 10/500 [10] | 10/500 [10] |



| | |
|----------------------|--|
| CODE | 145-73903 |
| BARCODE | 5207227249051 |
| PRODUCT TYPE | ΕΝΩΤΙΚΗ ΓΩΝΙΑ CORNER TYPE CONNECTOR |
| L×W×H [mm] | 17 x 14 x 5 |
| PACKING [MOQ] | 10/500 [10] |

SMD LED Strip - 8mm



| | | | |
|----------------------|--|----------------------|--|
| CODE | 145-73910 | 145-73911 | 145-73912 |
| BARCODE | 5207227249099 | 5207227249112 | 5207227249136 |
| PRODUCT TYPE | ΦΙΣ ΤΡΟΦΟΔΟΣΙΑΣ POWER PLUG CONNECTION | ΕΝΩΤΙΚΟ CONNECTOR | ΕΝΩΤΙΚΟ ΜΕ ΚΑΛΩΔΙΟ CONNECTOR WITH CABLE |
| L×W×H [mm] | 170 x 11 x 5 | 18 x 11 x 5 | 190 x 11 x 5 |
| PACKING [MOQ] | 10/500 [10] | 10/500 [10] | 10/500 [10] |



| | | | |
|----------------------|--|---------------------------------|--|
| CODE | 145-73913 | 145-73914 | 145-73915 |
| BARCODE | 5207227249150 | 5207227249174 | 5207227249198 |
| PRODUCT TYPE | ΕΝΩΤΙΚΗ ΓΩΝΙΑ CORNER TYPE CONNECTOR | ΕΝΩΤΙΚΟ ΤΑΦ T TYPE CONNECTOR | ΕΝΩΤΙΚΟΣ ΣΤΑΥΡΟΣ CROSS TYPE CONNECTOR |
| L×W×H [mm] | 20 x 16 x 5 | 45 x 28 x 5 | 44 x 44 x 5 |
| PACKING [MOQ] | 10/500 [10] | 10/500 [10] | 10/500 [10] |

SMD LED Strip - 10mm

 -20 | +45 °C
 
 IP44
 

CODE 145-73920
BARCODE 5207227249211
PRODUCT TYPE ΦΙΣ ΤΡΟΦΟΔΟΣΙΑΣ
 POWER PLUG CONNECTION
LxWxH [mm] 170 x 12 x 5
PACKING [MOQ] 10/500 [10]

145-73921
 5207227249235
 ΕΝΩΤΙΚΟ
 CONNECTOR
 18 x 12 x 5
 10/500 [10]

145-73922
 5207227249259
 ΕΝΩΤΙΚΟ ΜΕ ΚΑΛΩΔΙΟ
 CONNECTOR WITH CABLE
 190 x 12 x 5
 10/500 [10]



CODE 145-73923
BARCODE 5207227249273
PRODUCT TYPE ΕΝΩΤΙΚΗ ΓΩΝΙΑ
 CORNER TYPE CONNECTOR
LxWxH [mm] 30 x 30 x 11 x 5
PACKING [MOQ] 10/500 [10]

145-73924
 5207227249297
 ΕΝΩΤΙΚΟ ΤΑΦ
 T TYPE CONNECTOR
 45 x 28 x 5
 10/500 [10]

145-73925
 5207227249310
 ΕΝΩΤΙΚΟΣ ΣΤΑΥΡΟΣ
 CROSS TYPE CONNECTOR
 44 x 44 x 5
 10/500 [10]

SMD RGB LED Strip - 10mm

 -20 | +45 °C
 
 IP44
 

CODE 145-73930
BARCODE 5207227249334
PRODUCT TYPE ΦΙΣ ΤΡΟΦΟΔΟΣΙΑΣ
 POWER PLUG CONNECTION
LxWxH [mm] 170 x 12 x 5
PACKING [MOQ] 10/500 [10]

145-73931
 5207227249358
 ΦΙΣ ΤΡΟΦΟΔΟΣΙΑΣ DC
 POWER PLUG CONNECTION DC
 190 x 12 x 5
 10/500 [10]

145-73932
 5207227249372
 ΕΝΩΤΙΚΟ
 CONNECTOR
 18 x 12 x 5
 10/500 [10]

145-73933
 5207227249396
 ΕΝΩΤΙΚΟ ΜΕ ΚΑΛΩΔΙΟ
 CONNECTOR WITH CABLE
 190 x 12 x 5
 10/500 [10]



CODE 145-73934
BARCODE 5207227249419
PRODUCT TYPE ΕΝΩΤΙΚΗ ΓΩΝΙΑ
 CORNER TYPE CONNECTOR
LxWxH [mm] 30 x 30 x 11 x 5
PACKING [MOQ] 10/500 [10]

145-73935
 5207227249433
 ΕΝΩΤΙΚΟ ΤΑΦ
 T TYPE CONNECTOR
 45 x 28 x 5
 10/500 [10]

145-73936
 5207227249457
 ΕΝΩΤΙΚΟΣ ΣΤΑΥΡΟΣ
 CROSS TYPE CONNECTOR
 44 x 44 x 5
 10/500 [10]



SMD LED STRIP

SMD RGBW LED Strip - 12mm



| | | | | |
|----------------------|--|--|----------------------|--|
| CODE | 145-73940 | 145-73941 | 145-73942 | 145-73943 |
| BARCODE | 5207227249471 | 5207227249495 | 5207227249518 | 5207227249532 |
| PRODUCT TYPE | ΦΙΣ ΤΡΟΦΟΔΟΣΙΑΣ POWER PLUG CONNECTION | ΦΙΣ ΤΡΟΦΟΔΟΣΙΑΣ DC POWER PLUG CONNECTION DC | ΕΝΩΤΙΚΟ CONNECTOR | ΕΝΩΤΙΚΟ ΜΕ ΚΑΛΩΔΙΟ CONNECTOR WITH CABLE |
| LxWxH [mm] | 170 x 12 x 5 | 190 x 12 x 5 | 18 x 12 x 5 | 190 x 12 x 5 |
| PACKING [MOQ] | 10/500 [10] | 10/500 [10] | 10/500 [10] | 10/500 [10] |



| | | | |
|----------------------|--|---------------------------------|--|
| CODE | 145-73944 | 145-73945 | 145-73946 |
| BARCODE | 5207227249556 | 5207227249570 | 5207227249594 |
| PRODUCT TYPE | ΕΝΩΤΙΚΗ ΓΩΝΙΑ CORNER TYPE CONNECTOR | ΕΝΩΤΙΚΟ ΤΑΦ T TYPE CONNECTOR | ΕΝΩΤΙΚΟΣ ΣΤΑΥΡΟΣ CROSS TYPE CONNECTOR |
| LxWxH [mm] | 30 x 30 x 11 x 5 | 45 x 28 x 5 | 44 x 44 x 5 |
| PACKING [MOQ] | 10/500 [10] | 10/500 [10] | 10/500 [10] |



SMD LED STRIP

SMD Driver Free LED Strip 220V - 8mm



| | | | |
|----------------------|--|--------------------------|------------------|
| CODE | 145-73970 | 145-73971 | 145-73972 |
| BARCODE | 5207227437755 | 5207227437762 | 5207227437779 |
| PRODUCT TYPE | ΦΙΣ ΤΡΟΦΟΔΟΣΙΑΣ POWER PLUG CONNECTION | ΒΑΣΗ ΩΜΕΓΑ OMEGA BASE | ΤΑΠΑ END CAP |
| LxWxH [mm] | 170 x 11 x 5 | 28 x 8 x 8 | 9 x 18 x 8 |
| PACKING [MOQ] | 10/500 [10] | 10/500 [10] | 10/500 [10] |



ΚΟΛΛΗΤΙΚΗ ΤΑΙΝΙΑ 3m / GLUE TAPE 3m

 0 °C | +30 °C
 

8mm

10mm



CODE 145-72990
BARCODE 5207227257735
PRODUCT TYPE ΚΟΛΛΗΤΙΚΗ ΤΑΙΝΙΑ ΓΙΑ LED
 GLUE TAPE
LxWxH [mm] 50000 x 8 x 1
PACKING [MOQ] 10/500 [10]

CODE 145-72991
BARCODE 5207227257742
PRODUCT TYPE ΚΟΛΛΗΤΙΚΗ ΤΑΙΝΙΑ ΓΙΑ LED
 GLUE TAPE
LxWxH [mm] 50000 x 10 x 1
PACKING [MOQ] 10/500 [10]

PROFESSIONAL ACCESSORIES

DIMMER

ΕΝΙΣΧΥΤΕΣ ΣΗΜΑΤΟΣ

DMX CONTROLLER

Τα controller DMX, τα Dimmer και οι ενισχυτές σήματος διαχείρισης φωτισμού καθιστούν δυνατή την επίτευξη της ακριβούς φωτεινότητας, των επιπέδων χρώματος και των εφέ φωτισμού που επιθυμείτε από τον φωτισμό LED σας. Επιλέξτε από τη μεγάλη συλλογή μας, όπως διακόπτες τοίχου, διακόπτες in-line, ασύρματα τηλεχειριστήρια και ελεγκτές πολλαπλών καναλιών.

DIMMER

SIGNAL AMPLIFIERS

DMX CONTROLLER

DMX controllers, dimmers and signal amplifiers lighting management make it possible to achieve the precise brightness, color levels and effects lighting you want from your LED lighting. Choose from our large collection such as wall switches, switches in-line, wireless remotes and multi controllers channels.

Ασύρματο Dimmer LED Μονόχρωμης Ταινίας
Wireless Dimmer One Color LED Tape



Volt 12-24V 2.400-2.480GHz • Operating Temperature -20°C - +55°C
 Material Πλαστικό - FPC / Plastic - FPC

| Code | Barcode | Watt | Amperage mA | Packing | MOQ |
|-----------|---------------|--------|-------------|---------|-----|
| 145-71400 | 5207227241857 | 96-192 | 8000 | 1/100 | 1 |



DC 12V/96W, 24V/192W

Ασύρματο Dimmer LED Μονόχρωμης Ταινίας
Wireless Dimmer One Color LED Tape



Volt 12-24V 2.400-2.480GHz • Operating Temperature -20°C - +60°C
 Material Πλαστικό - FPC / Plastic - FPC

| Code | Barcode | Watt | Amperage mA | Packing | MOQ |
|-----------|---------------|---------|-------------|---------|-----|
| 145-71422 | 5207227433412 | 122-288 | 12000 | 1/100 | 1 |



DC 12V/122W, 24V/288W

Εξωτερικό Dimmer
External Dimmer



Volt 12-24V 2.400-2.480GHz • Operating Temperature -20°C - +60°C
 Material Πλαστικό - FPC / Plastic - FPC

| Code | Barcode | Watt | Amperage mA | Packing | MOQ |
|-----------|---------------|--------|-------------|---------|-----|
| 145-71405 | 5207227255335 | 96-192 | 8000 | 1/100 | 1 |



Ασύρματο Χειριστήριο RF Dimmer 4 Κανάλια
Wireless Control RF Dimmer 4 Channels



Volt 12-24V 2.400-2.480GHz • Operating Temperature -20°C - +55°C
 Material Πλαστικό - FPC / Plastic - FPC

| Code | Barcode | Watt | Amperage mA | Packing | MOQ |
|-----------|---------------|------|-------------|---------|-----|
| 145-71403 | 5207227241819 | | | 1/200 | 1 |



Συνδυάζεται με / Combined with:
 145-71404 & 145-71402

Ασύρματο Χειριστήριο RF Dimmer
Wireless RF Controller Dimmer



Volt 12-24V 2.400-2.480GHz • Operating Temperature -20°C - +55°C
 Material Πλαστικό - FPC / Plastic - FPC

| Code | Barcode | Watt | Amperage mA | Packing | MOQ |
|-----------|---------------|---------|-------------|---------|-----|
| 145-71402 | 5207227241796 | 122-288 | 12000 | 1/200 | 1 |



Συνδυάζεται με / Combined with:
 145-71403 & 145-71404

DC 12V/122W, 24V/288W

Ασύρματο Χειριστήριο RF WiFi Dimmer Controller Rf WiFi Dimmer



Volt 12-24V 2.400-2.480GHz • Operating Temperature -20°C - +55°C
Material Πλαστικό - FPC / Plastic - FPC

| Code | Barcode | Watt | Amperage mA | Packing | MOQ |
|-----------|---------------|---------|-------------|---------|-----|
| 145-71404 | 5207227241833 | 122-288 | 12000 | 1/200 | 1 |

Συνδυάζεται με / Combined with:
145-71403 & 145-71406

DC 12V/122W, 24V/288W

Ασύρματο Χειριστήριο Τοίχου RF Dimmer 4 Κανάλια Wireless Wall Control RF Dimmer 4 Channels



Volt 12-24V 2.400-2.480GHz • Operating Temperature -10°C - +40°C
Material Πλαστικό - FPC / Plastic - FPC

| Code | Barcode | Watt | Amperage mA | Packing | MOQ |
|-----------|---------------|------|-------------|---------|-----|
| 145-71406 | 5207227433351 | | | 1/200 | 1 |

Συνδυάζεται με / Combined with:
145-71404 & 145-71402



ΑΣΥΡΜΑΤΟ / WIRELESS IR CONTROLLER RGB



Volt 5-24V 2.400-2.480GHz · Operating Temperature -20°C / +55°C
Material Πλαστικό - FPC / Plastic - FPC

| Code | Barcode | Watt | Amperage mA | Packing | MOQ |
|-----------|---------------|--------|-------------|---------|-----|
| 145-71410 | 5207227255342 | 30-165 | 6000 | 1/100 | 1 |



DC 5V/30W 12V/72W 24V/165W

ΑΣΥΡΜΑΤΟ / WIRELESS IR CONTROLLER RGB



Volt 5-24V 2.400-2.480GHz · Operating Temperature -20°C / +55°C
Material Πλαστικό - FPC / Plastic - FPC

| Code | Barcode | Watt | Amperage mA | Packing | MOQ |
|-----------|---------------|---------|-------------|---------|-----|
| 145-71421 | 5207227433399 | 122-288 | 12000 | 1/100 | 1 |



DC 12V/122W, 24V/288W

**Ασύρματο Χειριστήριο Rf WiFi RGBW 4 Κανάλια
Wireless Wall Control Rf WiFi RGBW 4 Channels**



2.400-2.480GHz · Operating Temperature -20°C / +55°C
Material Πλαστικό - FPC / Plastic - FPC

| Code | Barcode | Watt | Amperage mA | Packing | MOQ |
|-----------|---------------|------|-------------|---------|-----|
| 145-71413 | 5207227241871 | | | 1/200 | 1 |



Συνδυάζεται με / Combined with:
145-71415

**Ασύρματο Χειριστήριο Rf WiFi RGBW
Wireless Control Rf WiFi RGBW**



Volt 12-24V 2.400-2.480GHz · Operating Temperature -20°C / +55°C
Material Πλαστικό - FPC / Plastic - FPC

| Code | Barcode | Watt | Amperage mA | Packing | MOQ |
|-----------|---------------|---------|-------------|---------|-----|
| 145-71415 | 5207227241918 | 120-240 | 10000 | 1/200 | 1 |



DC 12V/120W, 24V/240W

Συνδυάζεται με / Combined with:
145-71413 & 145-71419

Ασύρματο Χειριστήριο Τοίχου RF WiFi RGBW 4 Κανάλια
Wireless Wall Control RF WiFi RGBW 4 Channels

IP20

PRO
SERIES

3
YEARS
WARRANTY

WiFi

NEW



2.400-2.480GHz · Operating Temperature -20°C / +55°C
Material Πλαστικό - FPC / Plastic - FPC

| Code | Barcode | Watt | Amperage mA | Packing | MOQ |
|-----------|---------------|------|----------------|---------|-----|
| 145-71419 | 5207227433375 | | | 1/200 | 1 |

Συνδυάζεται με / Combined with:
145-71415



ΦΩΤΙΣΜΟΣ - PROFESSIONAL LIGHTING

Dimmer Χωνευτό για Μονόχρωμη Ταινία LED
Dimmer Recessed for One Color LED Tape



Volt 12-24V 2.400-2.480GHz • Operating Temperature -20°C / +55°C
 Material Πλαστικό - FPC / Plastic - FPC

| Code | Barcode | Watt | Amperage mA | Packing | MOQ |
|-----------|---------------|---------|-------------|---------|-----|
| 145-71450 | 5207227255410 | 180-360 | 15000 | 1/100 | 1 |



DC 12V/180W, 24V/360W

Dimmer Χωνευτό για CCT Ταινία LED 2 Καναλιών
Dimmer Recessed for CCT LED Tape 2 Channels



Volt 12-24V 2.400-2.480GHz • Operating Temperature -20°C / +55°C
 Material Πλαστικό - FPC / Plastic - FPC

| Code | Barcode | Watt | Amperage mA | Packing | MOQ |
|-----------|---------------|---------|-------------|---------|-----|
| 145-71451 | 5207227255403 | 180-360 | 15000 | 1/100 | 1 |



DC 12V/180W, 24V/360W

Dimmer Χωνευτό για Ταινία LED RGBWW 5 Καναλιών
Dimmer Recessed for RGBWW LED Tape 5 Channels



Volt 12-24V 2.400-2.480GHz • Operating Temperature -20°C / +55°C
 Material Πλαστικό - FPC / Plastic - FPC

| Code | Barcode | Watt | Amperage mA | Packing | MOQ |
|-----------|---------------|---------|-------------|---------|-----|
| 145-71452 | 5207227255427 | 180-360 | 15000 | 1/100 | 1 |



DC 12V/180W, 24V/360W

Dimmer Χωνευτό για Ταινία LED T18-1W
Dimmer Recessed for T18-1W LED Tape



Volt 100-240V 2.400-2.480GHz • Operating Temperature -20°C / +55°C
 Material Πλαίσιο Αλουμινίου - FPC / Aluminum - FPC

| Code | Barcode | Watt | Amperage mA | Packing | MOQ |
|-----------|---------------|------|-------------|---------|-----|
| 145-71453 | 5207227241932 | | 20 | 1/50 | 1 |



Ενισχυτής Σήματος για Μονόχρωμη Ταινία
Signal Amplifier for One Color Tape



Volt 12-24V · Operating Temperature -20°C / +55°C
Material Πλαίσιο Αλουμινίου - FPC / Aluminum - FPC

| Code | Barcode | Watt | Amperage mA | Packing | MOQ |
|-----------|---------------|---------|-------------|---------|-----|
| 145-71470 | 5207227241956 | 165-288 | 12000 | 1/100 | 1 |



DC 12V/165W, 24V/288W

Ενισχυτής Σήματος για Ταινία RGB
Signal Amplifier for RGB Tape



Volt 12-24V · Operating Temperature -20°C / +55°C
Material Πλαίσιο Αλουμινίου - FPC / Aluminum - FPC

| Code | Barcode | Watt | Amperage mA | Packing | MOQ |
|-----------|---------------|---------|-------------|---------|-----|
| 145-71471 | 5207227255434 | 165-288 | 12000 | 1/100 | 1 |



DC 12V/165W, 24V/288W

Ενισχυτής Σήματος για Ταινία RGB
Signal Amplifier for RGB Tape



Volt 12-24V · Operating Temperature -20°C / +55°C
Material Πλαίσιο Αλουμινίου - FPC / Aluminum - FPC

| Code | Barcode | Watt | Amperage mA | Packing | MOQ |
|-----------|---------------|---------|-------------|---------|-----|
| 145-71472 | 5207227255441 | 288-576 | 24000 | 1/81 | 1 |



DC 12V/288W, 24V/576W

Ενισχυτής Σήματος για Ταινία RGBW DC 6AX4
Signal Amplifier for RGBW Tape DC 6AX4



Volt 12-24V · Operating Temperature -20°C / +55°C
Material Πλαίσιο Αλουμινίου - FPC / Aluminum - FPC

| Code | Barcode | Watt | Amperage mA | Packing | MOQ |
|-----------|---------------|---------|-------------|---------|-----|
| 145-71473 | 5207227241970 | 288-576 | 24000 | 1/100 | 1 |



DC 12V/288W, 24V/576W

**DMX512/RDM Decoder "D4-L" RGBW
12-24VDC/4CH*5A**



Volt 12-24V 250/500/1000/2000/4000/8000/16000Hz • Operating Temperature -30°C / +55°C
Material Πλαστικό - FPC / Plastic - FPC

| Code | Barcode | Watt | Amperage mA | Packing | MOQ |
|-----------|---------------|----------|-------------|---------|-----|
| 145-71503 | 5207227242038 | 4x60-120 | 4x5000 | 1/100 | 1 |



4X (12V/60W - 24V/120W)

**DMX512/RDM Decoder "D4-XE" RGBW
12-36VDC/4CH*8A**



Volt 12-36V 2000 / 500Hz • Operating Temperature -30°C / +55°C
Material Πλαίσιο Αλουμινίου - FPC / Aluminum - FPC

| Code | Barcode | Watt | Amperage mA | Packing | MOQ |
|-----------|---------------|----------|-------------|---------|-----|
| 145-71500 | 5207227242113 | 4x96-288 | 4x8000 | 1/30 | 1 |



DC 4x(12V/96-36V/288W)

**DMX512/RDM Decoder "D5-E" RGB+CCT
12-48VDC/5CH*4A**



Volt 12-48V 250/500/1000/2000/4000/8000/16000Hz • Operating Temperature -30°C / +55°C
Material Πλαίσιο Αλουμινίου - FPC / Aluminum - FPC

| Code | Barcode | Watt | Amperage mA | Packing | MOQ |
|-----------|---------------|----------|-------------|---------|-----|
| 145-71501 | 5207227241994 | 5x48-192 | 5x4000 | 1/30 | 1 |



DC 5X(12V/48-48V/192W)

**DMX512/RDM Decoder "D12A" RGB
12-24VDC/12CH*5A**



Volt 12-24V 250/500/2000/8000Hz • Operating Temperature -30°C / +55°C
Material Πλαίσιο Αλουμινίου - FPC / Aluminum - FPC

| Code | Barcode | Watt | Amperage mA | Packing | MOQ |
|-----------|---------------|-----------|-------------|---------|-----|
| 145-71502 | 5207227242014 | 12x60-120 | 12x5000 | 1/10 | 1 |



12X (12V/60W - 24V/120W)

**DMX512/RDM Decoder "D24B" RGBW
12-24VDC/24CH*4A**



Volt 12-24V • Operating Temperature -30°C / +55°C
Material Σιδερένιο πλαίσιο - FPC / Iron - FPC

| Code | Barcode | Watt | Amperage mA | Packing | MOQ |
|-----------|---------------|-----------|-------------|---------|-----|
| 145-71508 | 5207227430565 | 1152-2304 | 24x4000 | 1/25 | 1 |



DMX512/RDM Decoder Πάγας "D4"
Μονόχρωμο/CCT/RGBW 12-24VDC/4CH*5A



Volt 12-24V 2000 / 500Hz · Operating Temperature -30°C / +55°C
 Material Πλαστικό - FPC / Plastic - FPC

| Code | Barcode | Watt | Amperage mA | Packing | MOQ |
|-----------|---------------|----------|-------------|---------|-----|
| 145-71504 | 5207227242052 | 4x60-120 | 4x5000 | 1/50 | 1 |



4X (12V/2000 - 24V500HZ)

DMX512/RDM Decoder IP65 "D4-WPS" RGBW
12-24VDC/4CH*5A 36-48VDC/4CH*4A



Volt 12-36V 250/500/1000/2000/4000/8000/16000Hz · Operating Temperature -30°C / +55°C
 Material Πλαστικό - FPC / Plastic - FPC

| Code | Barcode | Watt | Amperage mA | Packing | MOQ |
|-----------|---------------|----------|-------------|---------|-----|
| 145-71505 | 5207227242137 | 4x60-180 | 4x5000 | 1/25 | 1 |



4X (12V/60W - 36V/180W)

DMX512/RDM Decoder Πάγας "D12" RGB
12-24VDC/12CH*5A



Volt 12-24V 250/500/2000/8000Hz · Operating Temperature -30°C / +55°C
 Material Πλαστικό - FPC / Plastic - FPC

| Code | Barcode | Watt | Amperage mA | Packing | MOQ |
|-----------|---------------|-----------|-------------|---------|-----|
| 145-71506 | 5207227242076 | 12x60-120 | 12x5000 | 1/10 | 1 |



12 X (12V/60 - 24V/120)W

WiFi DMX512 Master WiFi "WT-DMX-S"
Μονόχρωμο/CCT/RGB/RGBW/RGB+CCT
12-36VDC/1-5CH



Volt 12-36V · Operating Temperature -30°C / +55°C
 Material Πλαίσιο Αλουμινίου - FPC / Aluminum - FPC

| Code | Barcode | Watt | Amperage mA | Packing | MOQ |
|-----------|---------------|------|-------------|---------|-----|
| 145-71509 | 5207227430589 | | | 1/100 | 1 |



**DMX Master/RF Χωνευτό "T11-1" Μονόχρωμο
100-240VAC 4 Διαδρομές**



Volt 100-240V · Operating Temperature -30°C / +55°C
Material Γυαλί - Πλαίσιο Πολυκαρβονικού - FPC / Glass - PC - FPC

| Code | Barcode | Watt | Amperage mA | Packing | MOQ |
|-----------|---------------|------|-------------|---------|-----|
| 145-71513 | 5207227430602 | | | 1/50 | 1 |



**DMX Master/RF Χωνευτό "T15(IT)" Μονόχρωμο/
CCT/RGB/RGBW/RGB+CCT 100-240VAC 4
Διαδρομές**



Volt 100-240V · Operating Temperature -30°C / +55°C
Material Γυαλί - Πλαίσιο Πολυκαρβονικού - FPC / Glass - PC - FPC

| Code | Barcode | Watt | Amperage mA | Packing | MOQ |
|-----------|---------------|------|-------------|---------|-----|
| 145-71514 | 5207227430602 | | | 1/50 | 1 |



DMX Κονσόλα "AJ6" 6 Διαδρομές



Volt 5-12V · Operating Temperature -30°C / +55°C
Material Πλαίσιο Αλουμινίου - FPC / Aluminum - FPC

| Code | Barcode | Watt | Amperage mA | Packing | MOQ |
|-----------|---------------|------|-------------|---------|-----|
| 145-72550 | 5207227242212 | | | 1/50 | 1 |



ΕΝΙΣΧΥΤΗΣ DMX - AMPLIFIER DMX

**DMX512 AMPLIFIER Ράγας "DA" 12-36VDC 2
Κανάλια**



Volt 12-36V · Operating Temperature -30°C / +55°C
Material Πλαίσιο Αλουμινίου - FPC / Aluminum - FPC

| Code | Barcode | Watt | Amperage mA | Packing | MOQ |
|-----------|---------------|------|-------------|---------|-----|
| 145-71520 | 5207227242199 | | | 1/50 | 1 |



**DMX512 Splitter "DMA" 1 Είσοδος σε 4 Εξόδους
12-36VDC**



Volt 12-36V · Operating Temperature -30°C / +55°C
Material Πλαίσιο Αλουμινίου - FPC / Aluminum - FPC

| Code | Barcode | Watt | Amperage mA | Packing | MOQ |
|-----------|---------------|------|-------------|---------|-----|
| 145-71521 | 5207227242151 | | | 1/50 | 1 |



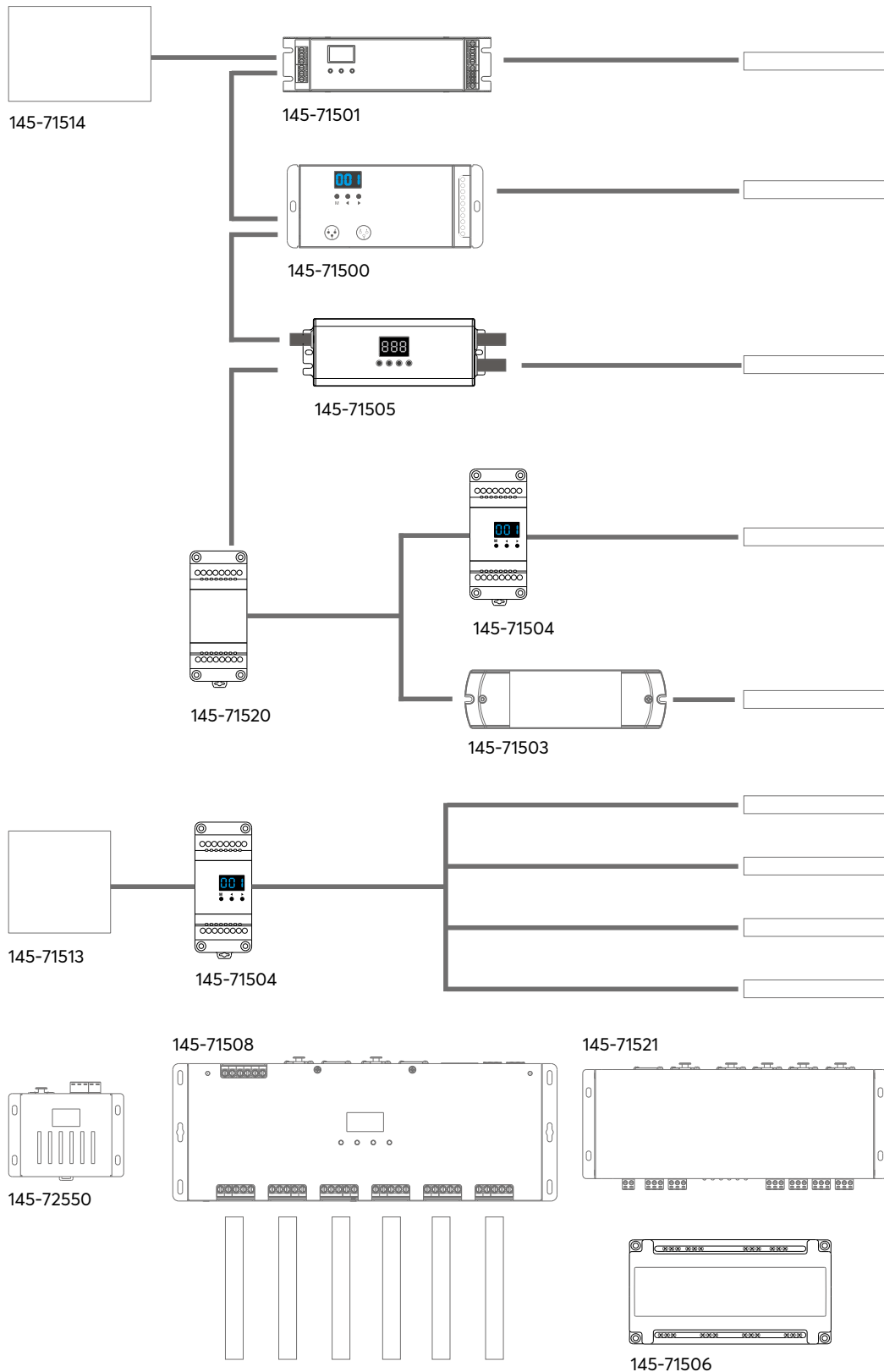

Το **Πρωτόκολλο DMX** είναι κατάλληλο για την αποτελεσματική "συνομιλία" μεταξύ των φωτιστικών, μέσω του συντονισμένου ελέγχου πολλών φωτιστικών. Σε αντίθεση με τα υπόλοιπα πρωτόκολλα, μπορεί να διαχειρίζεται διαφορετικές εντολές ταυτόχρονα, προσφέροντας εντυπωσιακούς συνδυασμούς μεταξύ των πηγών φωτισμού.

The **DMX Protocol** is ideal for effective "communication" between luminaires through the synchronized control of multiple fixtures. Unlike other protocols, it can handle different commands simultaneously, delivering impressive combinations across lighting sources.

Dimmer DALI LED "DA1" 1 Κανάλι
12-24VDC/1CH*15A 36-48VDC/1CH*10A



Volt 12-48V 2000HZ • Operating Temperature -30°C / +55°C
Material Πλαίσιο Αλουμινίου - FPC / Aluminum - FPC

| Code | Barcode | Watt | Amperage mA | Packing | MOQ |
|-----------|---------------|---------|-------------|---------|-----|
| 145-71600 | 5207227255489 | 180-360 | 2x5000 | 1/100 | 1 |

DC 12V/180W - 48V/360W

Dimmer DALI LED "DA4-M" 4 Κανάλια
12-24VDC/4CH*5A 36-48VDC/4CH*3A

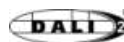

Volt 12-48V 2000HZ • Operating Temperature -20°C / +55°C
Material Πλαίσιο Αλουμινίου - FPC / Aluminum - FPC

| Code | Barcode | Watt | Amperage mA | Packing | MOQ |
|-----------|---------------|---------|-------------|---------|-----|
| 145-71606 | 5207227430688 | 240-432 | 4x5000 | 1/100 | 1 |

DC 12V/240W - 48V/432W

Dimmer DALI LED Ράγας "DA4-D" 4 Κανάλια
12-24VDC/4CH*5A 36-48VDC/4CH*3A



Volt 12-24V 500HZ • Operating Temperature -30°C / +55°C
Material Πλαίσιο Αλουμινίου - FPC / Aluminum - FPC

| Code | Barcode | Watt | Amperage mA | Packing | MOQ |
|-----------|---------------|----------|-------------|---------|-----|
| 145-71603 | 5207227255519 | 4x60-120 | 4x5000 | 1/100 | 1 |

DC 12V/4X60W - 24V/4X120W

DALI Master Χωνευτό "TD1-4S" 4 Διαδρομές
Μονόχρωμο RF



Volt 5-24V • Operating Temperature -20°C / +55°C
Material Γυαλί - Πλαίσιο Πολυκαρβονικού - FPC / Glass - PC - FPC

| Code | Barcode | Watt | Amperage mA | Packing | MOQ |
|-----------|---------------|------|-------------|---------|-----|
| 145-71604 | 5207227430640 | | | 1/50 | 1 |

DALI Master Χωνευτό "TD4-4S" 4 Διαδρομές
RGBW RF



Volt 5-24V • Operating Temperature -20°C / +55°C
Material Γυαλί - Πλαίσιο Πολυκαρβονικού - FPC / Glass - PC - FPC

| Code | Barcode | Watt | Amperage mA | Packing | MOQ |
|-----------|---------------|------|-------------|---------|-----|
| 145-71605 | 5207227430664 | | | 1/50 | 1 |

Τροφοδοτικό και Ενισχυτής BUS DALI
100-240VAC 250mA



Volt 100-240V · Operating Temperature -20°C / +55°C
Material Πλαίσιο Αλουμινίου - FPC / Aluminum - FPC



| Code | Barcode | Watt | Amperage mA | Packing | MOQ |
|-----------|---------------|------|-------------|---------|-----|
| 145-71610 | 5207227430701 | | 250 | 1/100 | 1 |

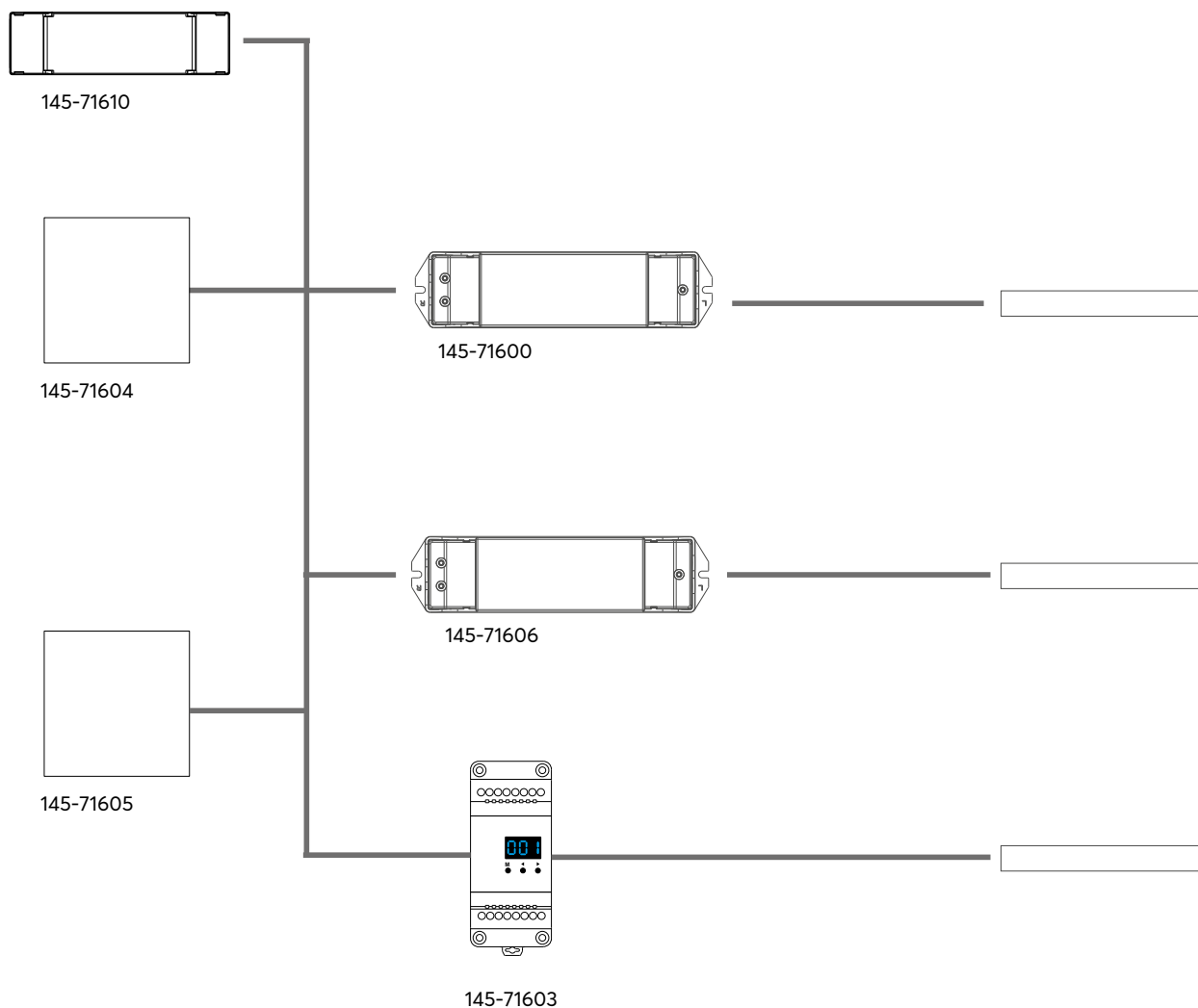

Χειριστείτε χωρίς παρεμβολές και με απλή καλωδίωση το σύστημα φωτισμού σας. **Το πρωτόκολλο επικοινωνίας DALI**, χαρακτηρίζεται από αποδοτική και οικονομική δυνατότητα ελέγχου πολλών πηγών.
Operate your lighting system interference-free and with simple wiring. **The DALI communication protocol** is distinguished by its efficient and cost-effective capability to control multiple sources.

Ασύρματο Controller RF Wifi & Bluetooth PIXEL 5-24VDC, 2CH (Max. 2048 PIXEL)



Volt 5-24V • Operating Temperature -20°C / +55°C
Material Πλαστικό - FPC / Plastic - FPC

| Code | Barcode | Watt | Amperage mA | Packing | MOQ |
|-----------|---------------|-------|-----------------|---------|-----|
| 145-71430 | 5207227255397 | 24-48 | 12V-12A/ 24V-6A | 1/200 | 1 |



SPI Spliter (PIXEL) "SA6" 1 Ομάδα σε 6 Ομάδες 5-24VDC



Volt 5-24V • Operating Temperature -20°C / +55°C
Material Σιδερένιο πλαίσιο - FPC / Iron - FPC

| Code | Barcode | Watt | Amperage mA | Packing | MOQ |
|-----------|---------------|------|-------------|---------|-----|
| 145-71431 | 5207227430503 | | | 1/100 | 1 |



SPI RF Controller (PIXEL) "SC-L" 2 Έξοδοι 5-24VDC



Volt 5-24V • Operating Temperature -20°C / +55°C
Material Πλαίσιο Πολυκαρβονικού - FPC / PC - FPC

| Code | Barcode | Watt | Amperage mA | Packing | MOQ |
|-----------|---------------|------|-------------|---------|-----|
| 145-71432 | 5207227430527 | | | 1/130 | 1 |



SPI RF Remote Controller (PIXEL) "R9"



Operating Temperature -20°C / +55°C
Material Πλαστικό - FPC / Plastic - FPC

| Code | Barcode | Watt | Amperage mA | Packing | MOQ |
|-----------|---------------|------|-------------|---------|-----|
| 145-71433 | 5207227430541 | | | 1/100 | 1 |



Κατάλληλα για την καλύτερη δυνατή διαχείριση, των πολλών δυνατοτήτων των LED Ταινιών, τεχνολογίας Pixel. Οι ταινίες Pixel προτείνονται για τη διακόσμηση χώρων, λόγω των πολλών δυνατοτήτων τους στη δημιουργία εφέ φωτισμού. Suitable for optimal management of the numerous capabilities of Pixel LED Strips. Pixel strips are recommended for space decoration due to their extensive possibilities in creating lighting effects.

Διακόπτης - Αισθητήρας (Πόρτας) "E1-D" 12-24VDC 4A

IP00

PRO
SERIES5
YEARS
WARRANTY

NEW

Volt 12-24V 128HZ · Operating Temperature -30°C / +55°C
Material Πλαίσιο Αλουμινίου - FPC / Aluminum - FPC

| Code | Barcode | Watt | Amperage mA | Packing | MOQ |
|-----------|---------------|-------|----------------|---------|-----|
| 145-71650 | 5207227430725 | 48-96 | 5000 | 1/100 | 1 |



DC 12V/48 - 24V/96W

Αισθητήρας Κίνησης PIR "E1-R" 12-24VDC 3A

IP00

PRO
SERIES5
YEARS
WARRANTY

NEW

Volt 12-24V · Operating Temperature -30°C / +55°C
Material Πλαίσιο Αλουμινίου - FPC / Aluminum - FPC

| Code | Barcode | Watt | Amperage mA | Packing | MOQ |
|-----------|---------------|-------|----------------|---------|-----|
| 145-71651 | 5207227430749 | 36-72 | 3000 | 1/100 | 1 |



DC 12V/36 - 24V/72W

Αισθητήρας Κίνησης με Controller "ES32" 5-24VDC/32CH*1A για Σκάλες

IP20

PRO
SERIES5
YEARS
WARRANTY

NEW

Volt 5-24V 500HZ · Operating Temperature -30°C / +55°C
Material Σιδερένιο πλαίσιο - FPC / Iron - FPC

| Code | Barcode | Watt | Amperage mA | Packing | MOQ |
|-----------|---------------|---------|----------------|---------|-----|
| 145-71652 | 5207227430763 | 160-768 | 3000 | 1/10 | 1 |



DC 5V/160 - 24V/768W

Application

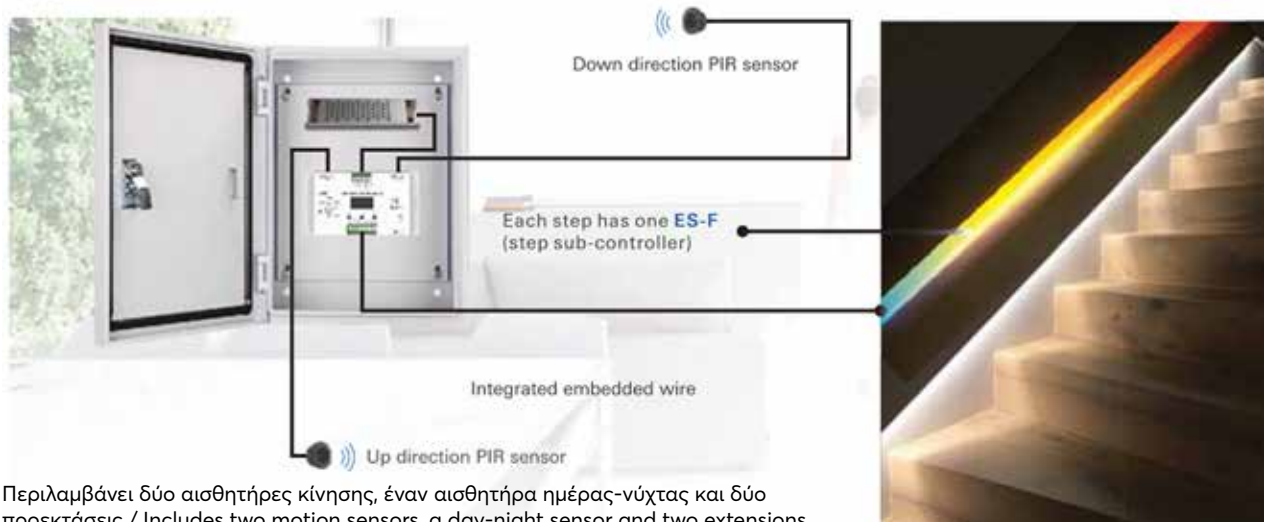

Περιλαμβάνει δύο αισθητήρες κίνησης, έναν αισθητήρα ημέρας-νύχτας και δύο προεκτάσεις / Includes two motion sensors, a day-night sensor and two extensions

Με τη νέα σειρά **SENSOR** της EUROLAMP, μπορείτε να διαχειριστείτε τις ταινίες LED, μέσω της κίνησης. Ιδανικά για μικρές κινήσεις όπως πόρτες, ντουλάπες κλπ, αλλά και για μεγαλύτερες αποστάσεις.
With the new EUROLAMP series **SENSOR**, you can control LED strips through motion. Ideal for small movements such as doors and closets, as well as for longer distances.

LED DRIVERS

ΤΡΟΦΟΔΟΤΙΚΑ DC

Τα τροφοδοτικά DC παρέχουν σταθερό ρεύμα, σταθερή τάση ή συνδυασμό και των δύο για να παρέχουν σταθερή ροή ισχύος σε στοιχεία φωτισμού LED. Τα τροφοδοτικά LED της EUROLAMP λόγω της ποιότητάς τους, επιτυγχάνουν πρόσθετα εξοικονόμηση ενέργειας, οικονομία στην κατανάλωση ηλεκτρικού ρεύματος και μεγάλη διάρκεια ζωής.

DC POWER SUPPLIES

DC power supplies provide constant current, constant voltage or a combination of both to provide constant power flow in LED lighting elements. The LED power supplies of EUROLAMP due to their quality, succeed additional energy saving, economy in power consumption and long life.

Τροφοδοτικό Μεταλλικό Mini 12V DC - Driver Metallic Mini 12V DC



Volt 200-240V 50/60Hz • Operating Temperature -20°C / +40°C • Material Αλουμίνιο / Aluminium

| Code | Barcode | Watt | Amperage mA | Dimension (mm) | | | Packing | MOQ |
|-----------|---------------|------|-------------|----------------|------|----|---------|-----|
| | | | | ↗ | ↔ | ↘ | | |
| 145-71000 | 5207227216237 | 18 | 1500 | 172 x | 18 x | 18 | 1/200 | 1 |
| 145-71001 | 5207227216244 | 24 | 2000 | 172 x | 18 x | 18 | 1/200 | 1 |
| 145-71002 | 5207227216251 | 36 | 3000 | 282 x | 18 x | 18 | 1/100 | 1 |
| 145-71003 | 5207227216268 | 48 | 4000 | 312 x | 18 x | 18 | 1/100 | 1 |
| 145-71004 | 5207227216275 | 60 | 5000 | 312 x | 18 x | 18 | 1/100 | 1 |
| 145-71005 | 5207227216282 | 75 | 6000 | 375 x | 18 x | 18 | 1/100 | 1 |



145-71000



145-71001



145-71002



145-71003



145-71004



145-71005



Τροφοδοτικό Μεταλλικό Mini 12V DC - Driver Metallic Mini 12V DC



Volt 200-240V 50/60Hz • Operating Temperature -20°C / +40°C • Material Αλουμίνιο / Aluminium

| Code | Barcode | Watt | Amperage mA | Dimension (mm) | | | Packing | MOQ |
|-----------|---------------|------|-------------|----------------|---------|-------|---------|-----|
| | | | | ↗ | ↔ | ↘ | | |
| 145-71060 | 5207227426803 | 18 | 1500 | 192 x | 18 x | 15 | 1/200 | 1 |
| 145-71061 | 5207227426827 | 24 | 2000 | 192 x | 18 x | 15 | 1/200 | 1 |
| 145-71062 | 5207227426841 | 36 | 3000 | 315 x | 18 x | 15 | 1/100 | 1 |
| 145-71063 | 5207227426865 | 48 | 4000 | 201 x | 19.40 x | 19.80 | 1/100 | 1 |
| 145-71064 | 5207227426889 | 60 | 5000 | 315 x | 18 x | 15 | 1/100 | 1 |
| 145-71065 | 5207227426902 | 75 | 6250 | 230 x | 19.40 x | 20.20 | 1/50 | 1 |
| 145-71066 | 5207227426926 | 100 | 8300 | 230 x | 25.90 x | 23.90 | 1/36 | 1 |
| 145-71067 | 5207227426940 | 120 | 10000 | 250 x | 25.8 x | 24 | 1/36 | 1 |
| 145-71068 | 5207227426964 | 200 | 16700 | 279 x | 25.80 x | 23.30 | 1/36 | 1 |



145-71060 - 61



145-71062 - 64



145-71065 - 68



Τροφοδοτικό Μεταλλικό Slim 12V DC - Driver Metallic Slim 12V DC



Volt 110-240V & 200-240V 50/60Hz • Operating Temperature -10°C / +40°C • Material Αλουμίνιο / Aluminium

| Code | Barcode | Watt | Volt Input | Amperage mA | Dimension (mm) | | | Packing | MOQ |
|-----------|---------------|------|------------|-------------|----------------|-------|----|---------|-----|
| | | | | | ↕ | ↔ | ↕ | | |
| 145-71010 | 5207227216299 | 10 | 110-240 | 830 | 71 x | 38 x | 31 | 1/200 | 1 |
| 145-71011 | 5207227216305 | 15 | 110-240 | 1250 | 71 x | 38 x | 31 | 1/200 | 1 |
| 145-71012 | 5207227216312 | 25 | 110-240 | 2000 | 85 x | 57 x | 34 | 1/200 | 1 |
| 145-71013 | 5207227216329 | 40 | 110-240 | 333 | 110 x | 78 x | 36 | 1/100 | 1 |
| 145-71014 | 5207227216336 | 60 | 110-240 | 5000 | 127 x | 46 x | 32 | 1/100 | 1 |
| 145-71015 | 5207227216343 | 100 | 110-240 | 8300 | 188 x | 46 x | 35 | 1/10 | 1 |
| 145-71016 | 5207227216350 | 120 | 110-240 | 10000 | 188 x | 46 x | 35 | 1/10 | 1 |
| 145-71017 | 5207227216367 | 150 | 110-240 | 12500 | 200 x | 58 x | 40 | 1/50 | 1 |
| 145-71018 | 5207227216374 | 200 | 200-240 | 16700 | 223 x | 68 x | 40 | 1/50 | 1 |
| 145-71019 | 5207227216381 | 250 | 200-240 | 20800 | 223 x | 68 x | 40 | 1/50 | 1 |
| 145-71020 | 5207227472343 | 350 | 200-240 | 29000 | 223 x | 68 x | 40 | 1/50 | 1 |
| 145-71021 | 5207227472350 | 400 | 200-240 | 33300 | 223 x | 68 x | 40 | 1/50 | 1 |
| 145-71022 | 5207227347092 | 500 | 200-240 | 41700 | 215 x | 112 x | 50 | 1/36 | 1 |
| 145-71023 | 5207227347115 | 600 | 200-240 | 50000 | 240 x | 125 x | 65 | 1/20 | 1 |
| 145-71024 | 5207227347139 | 700 | 200-240 | 58300 | 240 x | 125 x | 65 | 1/20 | 1 |



145-71010 - 11

145-71012

145-71013

145-71014

145-71015

145-71016

145-71017

145-71018

145-71019

Τροφοδοτικό Μεταλλικό Slim 12V DC - Driver Metallic Slim 12V DC



Volt 100-264V & 200-240V 50/60Hz • Operating Temperature -10°C / +40°C • Material Αλουμίνιο / Aluminium

| Code | Barcode | Watt | Volt Input | Amperage mA | Dimension (mm) | | | Packing | MOQ |
|-----------|---------------|------|------------|-------------|----------------|--------|----|---------|-----|
| | | | | | ↕ | ↔ | ↕ | | |
| 145-71030 | 5207227215810 | 24 | 100-264 | 2000 | 100 x | 40 x | 22 | 1/120 | 1 |
| 145-71031 | 5207227215827 | 36 | 100-264 | 3000 | 114 x | 49.5 x | 22 | 1/120 | 1 |
| 145-71032 | 5207227215834 | 60 | 200-240 | 5000 | 131 x | 52 x | 29 | 1/100 | 1 |
| 145-71033 | 5207227215841 | 100 | 200-240 | 8300 | 138 x | 50 x | 23 | 1/90 | 1 |
| 145-71034 | 5207227215858 | 120 | 200-240 | 10000 | 211 x | 52 x | 30 | 1/50 | 1 |
| 145-71035 | 5207227215865 | 150 | 200-240 | 12500 | 211 x | 52 x | 30 | 1/50 | 1 |
| 145-71036 | 5207227215872 | 200 | 200-240 | 16700 | 211 x | 52 x | 30 | 1/50 | 1 |
| 145-71037 | 5207227215889 | 250 | 200-240 | 20800 | 221 x | 62 x | 31 | 1/50 | 1 |
| 145-71038 | 5207227215568 | 350 | 200-240 | 29000 | 241 x | 62 x | 31 | 1/30 | 1 |
| 145-71039 | 5207227215582 | 400 | 200-240 | 33300 | 238 x | 50 x | 23 | 1/50 | 1 |



145-71030-31

145-71032

145-71033

145-71034 - 36

145-71037

145-71038 - 39

Τροφοδοτικό Μεταλλικό IP67 12V DC - Driver Metallic IP67 12V DC



Volt 110-264V & 200-240V 50/60Hz • Operating Temperature -20°C / +40°C • Material Αλουμίνιο / Aluminium

| Code | Barcode | Watt | Volt Input | Amperage mA | Dimension (mm) | | | Packing | MOQ |
|-----------|---------------|------|------------|-------------|----------------|------|----|---------|-----|
| | | | | | ↔ | ↕ | ↔ | | |
| 145-71050 | 5207227216176 | 30 | 110-264 | 2500 | 230 x | 30 x | 20 | 1/50 | 1 |
| 145-71051 | 5207227216183 | 45 | 110-264 | 3750 | 220 x | 30 x | 20 | 1/50 | 1 |
| 145-71052 | 5207227216190 | 60 | 110-264 | 5000 | 158 x | 43 x | 22 | 1/20 | 1 |
| 145-71053 | 5207227216206 | 100 | 110-264 | 8300 | 189 x | 65 x | 22 | 1/10 | 1 |
| 145-71054 | 5207227216213 | 150 | 110-264 | 12500 | 189 x | 65 x | 22 | 1/10 | 1 |
| 145-71055 | 5207227216220 | 200 | 200-240 | 16700 | 250 x | 72 x | 32 | 1/15 | 1 |



145-71050



145-71051



145-71052



145-71053



145-71054



145-71055



Τροφοδοτικό Μεταλλικό Slim Dimming (1-10V) 12V DC
Driver Metallic Slim Dimming (1-10V) 12V DC

10.000h

IP20

CE

PRO
SERIES

DIMMABLE

3
YEARS
WARRANTY

Volt 110-264V & 170-264V 50/60Hz • Operating Temperature -20°C / +40°C • Material Αλουμίνιο / Aluminium

| Code | Barcode | Watt | Volt Input | Amperage mA | Dimension (mm) ↔ ↔ ↓ | Packing | MOQ |
|-----------|---------------|------|------------|-------------|-------------------------|---------|-----|
| 145-71080 | 5207227215971 | 60 | 110-264 | 5000 | 190 x 50 x 30 | 1/10 | 1 |
| 145-71081 | 5207227215988 | 100 | 110-264 | 8300 | 230 x 50 x 30 | 1/40 | 1 |
| 145-71082 | 5207227215995 | 150 | 170-264 | 12500 | 287 x 50 x 30 | 1/35 | 1 |
| 145-71083 | 5207227216008 | 200 | 170-264 | 16700 | 287 x 50 x 30 | 1/35 | 1 |
| 145-71084 | 5207227216015 | 250 | 170-264 | 20800 | 287 x 50 x 30 | 1/35 | 1 |



145-71080



145-71081



145-71082



145-71083



145-71084

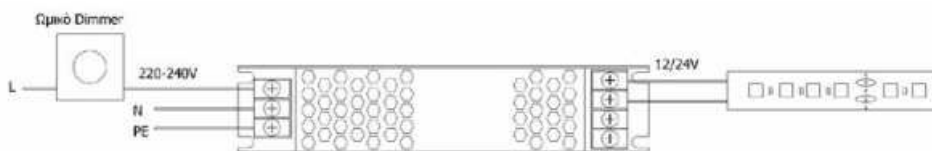
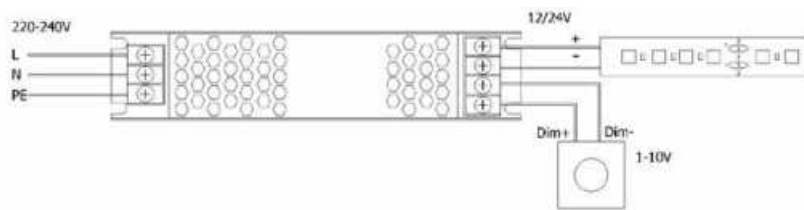

Τροφοδοτικό Μεταλλικό Μίνι 24V DC - Driver Metallic Mini 24V DC



Volt 200-240V 50/60Hz • Operating Temperature -20°C / +40°C • Material Αλουμίνιο / Aluminium

| Code | Barcode | Watt | Amperage mA | Dimension (mm) | | | Packing | MOQ |
|-----------|---------------|------|-------------|----------------|----|----|---------|-----|
| | | | | ↔ | ↔ | ↕ | | |
| 145-71100 | 5207227216398 | 18 | 750 | 172 | 18 | 18 | 1/200 | 1 |
| 145-71101 | 5207227216404 | 24 | 1000 | 172 | 18 | 18 | 1/200 | 1 |
| 145-71102 | 5207227216411 | 36 | 1500 | 282 | 18 | 18 | 1/100 | 1 |
| 145-71103 | 5207227216428 | 48 | 2000 | 312 | 18 | 18 | 1/100 | 1 |
| 145-71104 | 5207227216435 | 60 | 2500 | 312 | 18 | 18 | 1/100 | 1 |
| 145-71105 | 5207227216442 | 75 | 3000 | 375 | 18 | 18 | 1/100 | 1 |



145-71100



145-711001



145-711002



145-711003



145-711004



145-711005



Τροφοδοτικό Μεταλλικό Μίνι 24V DC - Driver Metallic Mini 24V DC



Volt 180-260V 50/60Hz • Operating Temperature -20°C / +40°C • Material Αλουμίνιο / Aluminium

| Code | Barcode | Watt | Amperage mA | Dimension (mm) | | | Packing | MOQ |
|-----------|---------------|------|-------------|----------------|-------|-------|---------|-----|
| | | | | ↔ | ↔ | ↕ | | |
| 145-71160 | 5207227426988 | 18 | 750 | 192 | 18 | 15 | 1/200 | 1 |
| 145-71161 | 5207227427008 | 24 | 1000 | 192 | 18 | 15 | 1/200 | 1 |
| 145-71162 | 5207227427022 | 36 | 1500 | 315 | 18 | 15 | 1/100 | 1 |
| 145-71163 | 5207227427046 | 48 | 2000 | 201 | 19.40 | 19.80 | 1/100 | 1 |
| 145-71164 | 5207227427060 | 60 | 2500 | 315 | 18 | 15 | 1/100 | 1 |
| 145-71165 | 5207227427084 | 75 | 3100 | 230 | 19.40 | 20.20 | 1/50 | 1 |
| 145-71166 | 5207227427107 | 100 | 4200 | 230 | 25.90 | 23.90 | 1/36 | 1 |
| 145-71167 | 5207227427121 | 120 | 5000 | 250 | 25.8 | 24 | 1/36 | 1 |
| 145-71168 | 5207227427145 | 200 | 8300 | 279 | 25.80 | 23.30 | 1/36 | 1 |



145-71160 - 61



145-71162 - 64



145-71165 - 68

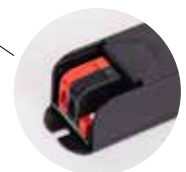



Τροφοδοτικό Μεταλλικό Slim 24V DC - Driver Metallic Slim 24V DC

Volt 200-240V 50/60Hz • Operating Temperature -20°C / +40°C • Material Αλουμίνιο / Aluminium

| Code | Barcode | Watt | Volt Input | Amperage mA | Dimension (mm) ↕ ↔ ↕ | Packing | MOQ |
|-----------|---------------|------|------------|-------------|-------------------------|---------|-----|
| 145-71110 | 5207227216459 | 15 | 110-240 | 630 | 71 x 38 x 31 | 1/200 | 1 |
| 145-71111 | 5207227216466 | 25 | 110-240 | 1040 | 85 x 57 x 34 | 1/200 | 1 |
| 145-71112 | 5207227216473 | 40 | 110-240 | 1670 | 110 x 78 x 36 | 1/100 | 1 |
| 145-71113 | 5207227216480 | 60 | 110-240 | 2500 | 127 x 46 x 32 | 1/100 | 1 |
| 145-71114 | 5207227216497 | 100 | 110-240 | 4170 | 188 x 46 x 35 | 1/10 | 1 |
| 145-71115 | 5207227216503 | 120 | 110-240 | 5000 | 188 x 46 x 35 | 1/10 | 1 |
| 145-71116 | 5207227216510 | 150 | 110-240 | 6250 | 200 x 58 x 40 | 1/50 | 1 |
| 145-71117 | 5207227216527 | 200 | 200-240 | 8300 | 223 x 68 x 40 | 1/50 | 1 |
| 145-71118 | 5207227216534 | 250 | 200-240 | 10000 | 223 x 68 x 40 | 1/50 | 1 |
| 145-71119 | 5207227403835 | 350 | 200-240 | 15000 | 223 x 68 x 40 | 1/50 | 1 |
| 145-71120 | 5207227472367 | 400 | 200-240 | 16700 | 223 x 68 x 40 | 1/50 | 1 |
| 145-71121 | 5207227347153 | 500 | 200-240 | 20800 | 215 x 112 x 50 | 1/36 | 1 |
| 145-71122 | 5207227347160 | 600 | 200-240 | 25000 | 240 x 125 x 65 | 1/20 | 1 |
| 145-71123 | 5207227347184 | 700 | 200-240 | 29200 | 240 x 125 x 65 | 1/20 | 1 |



Τροφοδοτικό Μεταλλικό Slim 24V DC - Driver Metallic Slim 24V DC



Volt 100-264V & 200-240V 50/60Hz • Operating Temperature -10°C / +40°C • Material Αλουμίνιο / Aluminium

| Code | Barcode | Watt | Volt Input | Amperage mA | Dimension (mm) ↕ ↔ ↕ | Packing | MOQ |
|-----------|---------------|------|------------|-------------|-------------------------|---------|-----|
| 145-71130 | 5207227215896 | 24 | 100-264 | 1000 | 135 x 35 x 24 | 1/135 | 1 |
| 145-71131 | 5207227215902 | 36 | 100-264 | 1500 | 135 x 35 x 24 | 1/135 | 1 |
| 145-71132 | 5207227215919 | 60 | 200-240 | 2500 | 135 x 35 x 23 | 1/96 | 1 |
| 145-71133 | 5207227215926 | 100 | 200-240 | 4170 | 138 x 50 x 23 | 1/90 | 1 |
| 145-71134 | 5207227215933 | 120 | 200-240 | 5000 | 178 x 50 x 23 | 1/65 | 1 |
| 145-71135 | 5207227215940 | 150 | 200-240 | 6250 | 178 x 50 x 23 | 1/65 | 1 |
| 145-71136 | 5207227215957 | 200 | 200-240 | 8300 | 178 x 50 x 23 | 1/65 | 1 |
| 145-71137 | 5207227215964 | 250 | 200-240 | 10000 | 205 x 50 x 23 | 1/60 | 1 |
| 145-71138 | 5207227215605 | 350 | 200-240 | 14600 | 238 x 50 x 23 | 1/50 | 1 |
| 145-71139 | 5207227215629 | 400 | 200-240 | 16670 | 238 x 50 x 23 | 1/50 | 1 |

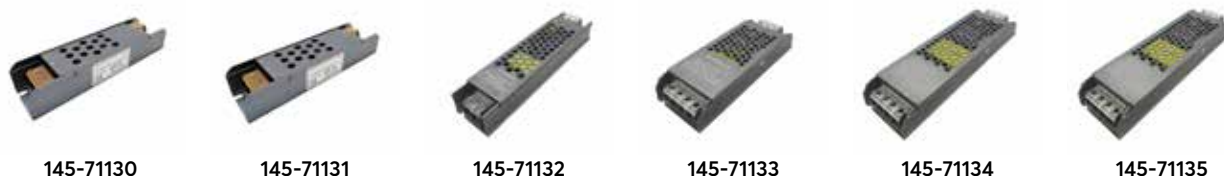

Τροφοδοτικό Μεταλλικό IP67 24V DC - Driver Metallic IP67 24V DC



Volt 110-264V & 200-240V 50/60Hz • Operating Temperature -20°C / +40°C • Material Αλουμίνιο / Aluminium

| Code | Barcode | Watt | Volt Input | Amperage mA | Dimension (mm) ↕ ↔ ↕ | Packing | MOQ |
|-----------|---------------|------|------------|-------------|-------------------------|---------|-----|
| 145-71150 | 5207227216114 | 30 | 110-264 | 1250 | 230 x 30 x 30 | 1/50 | 1 |
| 145-71151 | 5207227216121 | 45 | 110-264 | 1870 | 210 x 35 x 25 | 1/50 | 1 |
| 145-71152 | 5207227216138 | 60 | 110-264 | 2500 | 170 x 52 x 32 | 1/20 | 1 |
| 145-71153 | 5207227216145 | 100 | 110-264 | 4170 | 178 x 70 x 40 | 1/20 | 1 |
| 145-71154 | 5207227216152 | 150 | 110-264 | 6250 | 210 x 70 x 40 | 1/20 | 1 |
| 145-71155 | 5207227216169 | 200 | 200-240 | 8300 | 260 x 65 x 43 | 1/15 | 1 |



145-71150



145-71151



145-71152



145-71153



145-71154



145-71155

Τροφοδοτικό Μεταλλικό 48V DC - Driver Metallic 48V DC



Volt 170V-264V/AC 50/60Hz • Operating Temperature -20°C / +40°C • Material Αλουμίνιο / Aluminium

| Code | Barcode | Watt | Amperage mA | Dimension (mm) ↕ ↔ ↕ | Packing | MOQ |
|-----------|---------------|------|-------------|-------------------------|---------|-----|
| 145-71202 | 5207227216077 | 100 | 2100 | 191 x 61 x 29 | 1/40 | 1 |
| 145-71203 | 5207227216084 | 150 | 3100 | 191 x 61 x 29 | 1/40 | 1 |
| 145-71204 | 5207227216091 | 200 | 4160 | 220 x 61 x 29 | 1/40 | 1 |
| 145-71205 | 5207227216107 | 350 | 7300 | 220 x 61 x 29 | 1/40 | 1 |



145-71202 - 4



Τροφοδοτικό Μεταλλικό Slim Dimming 24V DC
Driver Metallic Slim Dimming 24V DC

10.000h

IP20

CE

PRO
SERIES

DIMMABLE

3
YEARS
WARRANTY

Volt 110-264V & 170-264V 50/60Hz • Operating Temperature -20°C / +40°C • Material Αλουμίνιο / Aluminium

| Code | Barcode | Watt | Volt Input | Amperage mA | Dimension (mm) | | | Packing | MOQ |
|-----------|---------------|------|------------|-------------|----------------|----|----|---------|-----|
| | | | | | ↕ | ↔ | ↕ | | |
| 145-71180 | 5207227216022 | 60 | 1/10 | 2500 | 190 | 50 | 30 | 110-264 | 1 |
| 145-71181 | 5207227216039 | 100 | 1/40 | 4170 | 230 | 50 | 30 | 110-264 | 1 |
| 145-71182 | 5207227216046 | 150 | 1/35 | 6250 | 287 | 50 | 30 | 170-264 | 1 |
| 145-71183 | 5207227216053 | 200 | 1/35 | 8300 | 287 | 50 | 30 | 170-264 | 1 |
| 145-71184 | 5207227216060 | 250 | 1/35 | 10000 | 287 | 50 | 30 | 170-264 | 1 |



145-71180



145-71181



145-71182



145-71183



145-71184

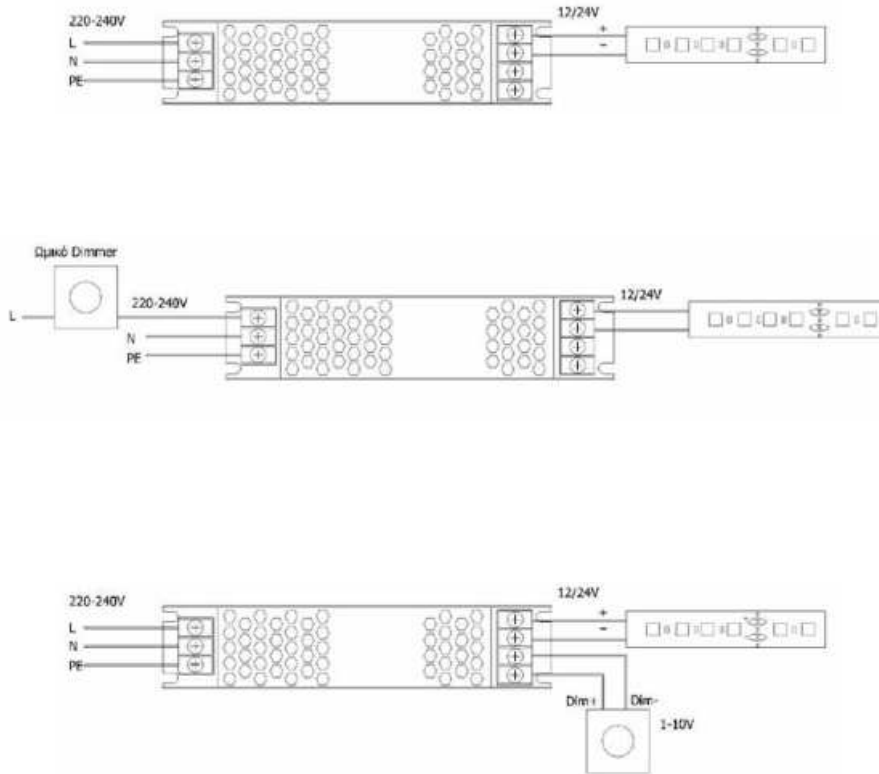



PROFILES

ΠΡΟΦΙΛ ΑΛΟΥΜΙΝΙΟΥ ΓΙΑ ΤΑΙΝΙΕΣ LED

Με σκοπό το καλύτερο αισθητικά αποτέλεσμα με βάση το γούστο σας η EUROLAMP σας προφέρει πολλές επιλογές σε υψηλής ποιότητας προφίλ αλουμινίου για ταινίες LED τόσο σε εξωτερικά όσο και σε κωνευτά.

Τα προφίλ αλουμινίου αποτελούν σημαντικό παράγοντα στην λειτουργία μιας ταινίας LED, διότι εκτός από την αισθητική εφαρμογή και την μηχανική προστασία προσφέρουν και σωστή ψύξη της ταινίας LED διασφαλίζοντας μεγαλύτερη διάρκεια ζωής.

LED STRIP SYSTEM PROFILES

To achieve the best aesthetic result based on your taste, EUROLAMP offers you many options in high quality aluminum profiles for LED strips both in external as well as in recessed ones.

Aluminum profiles are an important factor in operation of an LED strip, because apart from aesthetics application and the mechanical protection they offer as well proper cooling of the LED strip ensuring longer lifetime.

Προφίλ Μονή Ψύκτρα 2m
Profile Single Heatsink 2m

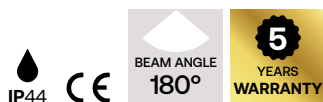

Info 18W/M Max • Material Αλουμίνιο / Aluminium

| Code | Barcode | Packing | MOQ |
|-----------|---------------|---------|-----|
| 145-70900 | 5207227159435 | 1/200 | 1 |

L×W×H [mm]
2000 x 13 x 3

Προφίλ Διπλή Ψύκτρα 2m
Profile Double Heatsink 2m

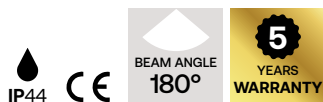

Info 18W/M Max • Material Αλουμίνιο / Aluminium

| Code | Barcode | Packing | MOQ |
|-----------|---------------|---------|-----|
| 145-70901 | 5207227159442 | 1/50 | 1 |

L×W×H [mm]
2000 x 30 x 3,5

Προφίλ Εξωτερικό 2m
Profile External 2m

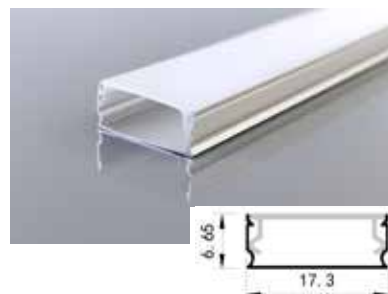
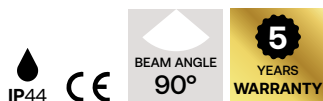

Material Πλαστικό - Αλουμίνιο / Plastic - Aluminium

| Code | Barcode | Packing | MOQ |
|-----------|---------------|---------|-----|
| 145-70928 | 5207227248399 | 1/200 | 1 |

Προφίλ Εξωτερικό 2m
Profile External 2m

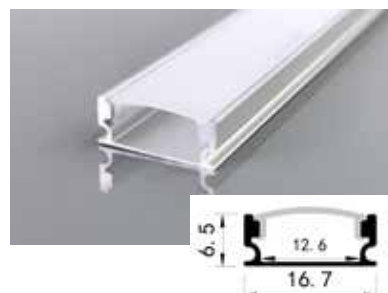
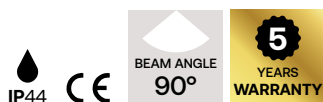

Material Πλαστικό - Αλουμίνιο / Plastic - Aluminium

| Code | Barcode | Packing | MOQ |
|-----------|---------------|---------|-----|
| 145-70902 | 5207227159459 | 1/100 | 1 |

Προφίλ Εξωτερικό 2m
Profile External 2m

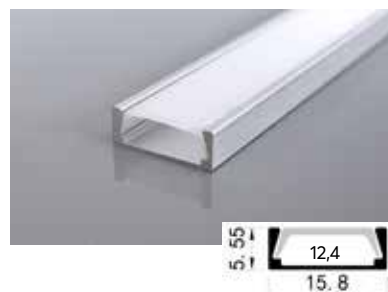

Material Πλαστικό - Αλουμίνιο / Plastic - Aluminium

| Code | Barcode | Packing | MOQ |
|-----------|---------------|---------|-----|
| 145-70952 | 5207227434815 | 1/160 | 1 |

Προφίλ Εξωτερικό 2m
Profile External 2m

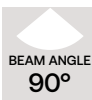

Info 18W/M Max • Material Πλαστικό - Αλουμίνιο / Plastic - Aluminium

| Code | Barcode | Packing | MOQ |
|-----------|---------------|---------|-----|
| 145-70903 | 5207227159466 | 1/120 | 1 |

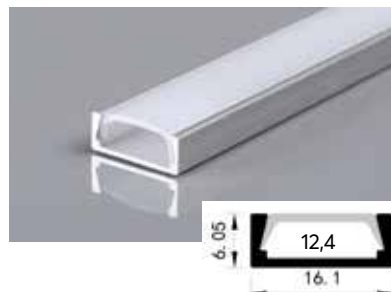

Προφίλ Εξωτερικό 2m
Profile External 2m



Material Πλαστικό - Αλουμίνιο / Plastic - Aluminium

| Code | Barcode | Packing | MOQ |
|-----------|---------------|---------|-----|
| 145-70953 | 5207227434839 | 1/120 | 1 |

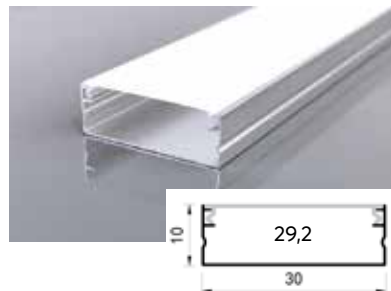

Προφίλ Εξωτερικό 2m
Profile External 2m



Material Πλαστικό - Αλουμίνιο / Plastic - Aluminium

| Code | Barcode | Packing | MOQ |
|-----------|---------------|---------|-----|
| 145-70927 | 5207227248382 | 1/90 | 1 |

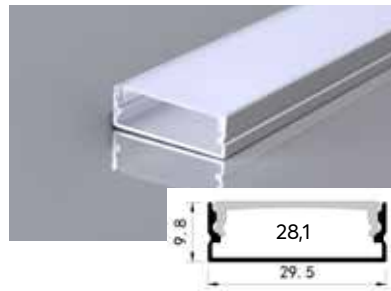

Προφίλ Εξωτερικό 2m
Profile External 2m



Info 18W/M Max • Material Πλαστικό - Αλουμίνιο / Plastic - Aluminium

| Code | Barcode | Packing | MOQ |
|-----------|---------------|---------|-----|
| 145-70906 | 5207227159497 | 1/120 | 1 |

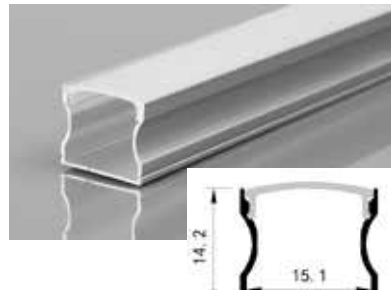

Προφίλ Εξωτερικό 2m
Profile External 2m



Info 10W/M Max • Material Πλαστικό - Αλουμίνιο / Plastic - Aluminium

| Code | Barcode | Packing | MOQ |
|-----------|---------------|---------|-----|
| 145-70908 | 5207227159510 | 1/120 | 1 |

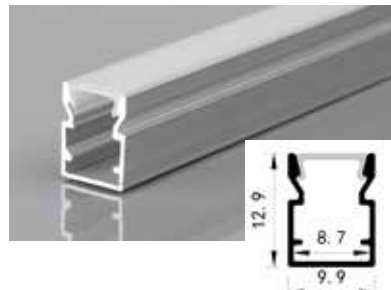

Προφίλ Εξωτερικό Μαύρο 2m
Profile External Black 2m

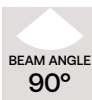

Info 18W/M Max • Material Πλαστικό - Αλουμίνιο / Plastic - Aluminium

| Code | Barcode | Packing | MOQ |
|-----------|---------------|---------|-----|
| 145-70950 | 5207227159633 | 1/120 | 1 |

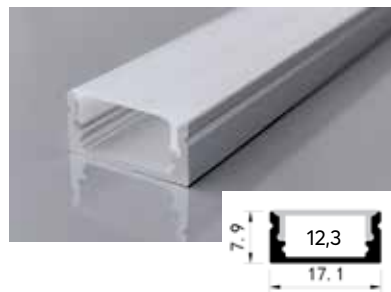

Προφίλ Εξωτερικό Εύκαμπτο 2m
Profile External Flexible 2m



Info 18W/M Max • Material Πλαστικό - Αλουμίνιο / Plastic - Aluminium

| Code | Barcode | Packing | MOQ |
|-----------|---------------|---------|-----|
| 145-70904 | 5207227159473 | 1/150 | 1 |

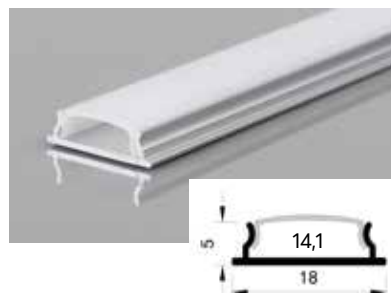

Προφίλ Εξωτερικό 2m
Profile External 2m

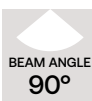

Info 18W/M Max • Material Πλαστικό - Αλουμίνιο / Plastic - Aluminium

| Code | Barcode | Packing | MOQ |
|-----------|---------------|---------|-----|
| 145-70915 | 5207227160332 | 1/90 | 1 |

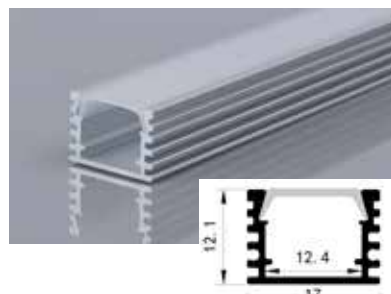

Προφίλ Εξωτερικό 2m
Profile External 2m



Material Πλαστικό - Αλουμίνιο / Plastic - Aluminium

| Code | Barcode | Packing | MOQ |
|-----------|---------------|---------|-----|
| 145-70954 | 5207227434853 | 1/60 | 1 |



Προφίλ Εξωτερικό Μίνι 2m
Profile External Mini 2m



Material Πλαστικό & Αλουμίνιο / Plastic & Aluminium

| Code | Barcode | Packing | MOQ |
|-----------|---------------|---------|-----|
| 145-70932 | 5207227260650 | 1/100 | 1 |



Προφίλ Γωνία 2m
Corner Profile 2m



Info 18W/M Max • Material Πλαστικό - Αλουμίνιο / Plastic - Aluminium

| Code | Barcode | Packing | MOQ |
|-----------|---------------|---------|-----|
| 145-70912 | 5207227159558 | 1/90 | 1 |

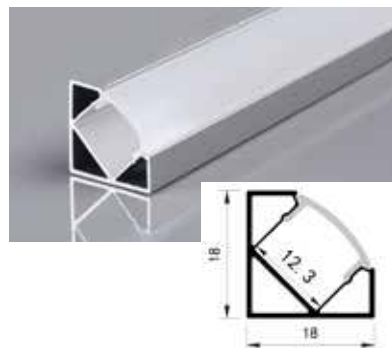

Προφίλ Γωνία 2m
Corner Profile 2m



Info 18W/M Max • Material Πλαστικό - Αλουμίνιο / Plastic - Aluminium

| Code | Barcode | Packing | MOQ |
|-----------|---------------|---------|-----|
| 145-70913 | 5207227159565 | 1/150 | 1 |

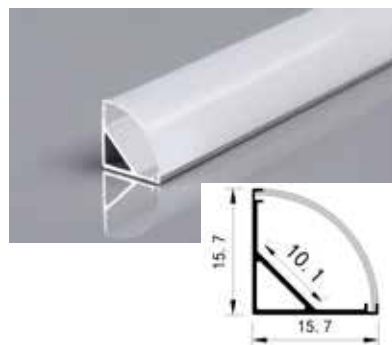

Προφίλ Γωνία Διπλό 2m
Corner Profile Double 2m



Info 36W/M Max • Material Πλαστικό - Αλουμίνιο / Plastic - Aluminium

| Code | Barcode | Packing | MOQ |
|-----------|---------------|---------|-----|
| 145-70914 | 5207227159572 | 1/60 | 1 |

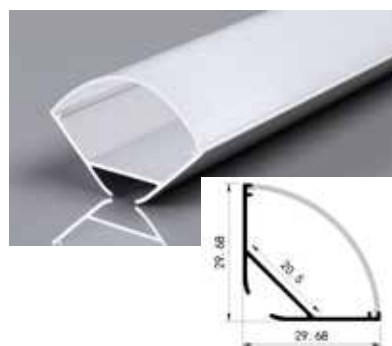

Προφίλ Χωνευτό 2m
Profile Recessed 2m



Info 18W/M Max • Material Πλαστικό - Αλουμίνιο / Plastic - Aluminium

| Code | Barcode | Packing | MOQ |
|-----------|---------------|---------|-----|
| 145-70955 | 5207227434877 | 1/200 | 1 |

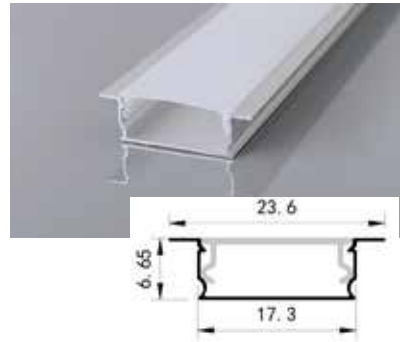

Προφίλ Χωνευτό 2m
Profile Recessed 2m



Info 18W/M Max • Material Πλαστικό - Αλουμίνιο / Plastic - Aluminium

| Code | Barcode | Packing | MOQ |
|-----------|---------------|---------|-----|
| 145-70905 | 5207227159480 | 1/150 | 1 |

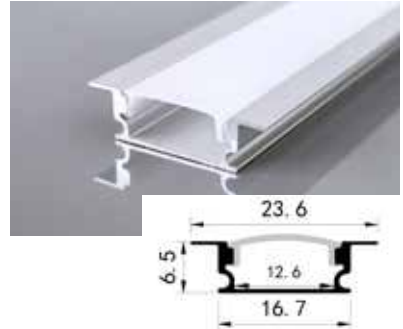

Προφίλ Χωνευτό Μαύρο 2m
Profile Recessed Black 2m



Info 18W/M Max • Material Πλαστικό - Αλουμίνιο / Plastic - Aluminium

| Code | Barcode | Packing | MOQ |
|-----------|---------------|---------|-----|
| 145-70951 | 5207227159640 | 1/90 | 1 |

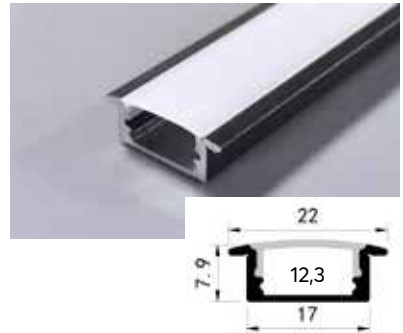

Προφίλ Χωνευτό 2m
Profile Recessed 2m



Info 18W/M Max • Material Πλαστικό - Αλουμίνιο / Plastic - Aluminium

| Code | Barcode | Packing | MOQ |
|-----------|---------------|---------|-----|
| 145-70907 | 5207227159503 | 1/120 | 1 |

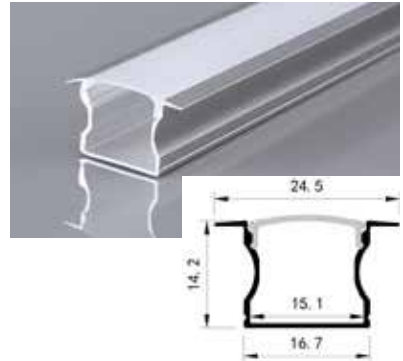

Προφίλ Χωνευτό 2m
Profile Recessed 2m



Info 10W/M Max • Material Πλαστικό - Αλουμίνιο / Plastic - Aluminium

| Code | Barcode | Packing | MOQ |
|-----------|---------------|---------|-----|
| 145-70909 | 5207227159527 | 1/120 | 1 |

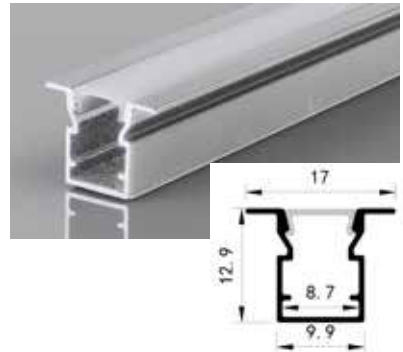

Προφίλ Χωνευτό 2m
Profile Recessed 2m



Info 18W/M Max • Material Πλαστικό - Αλουμίνιο / Plastic - Aluminium

| Code | Barcode | Packing | MOQ |
|-----------|---------------|---------|-----|
| 145-70910 | 5207227159534 | 1/40 | 1 |

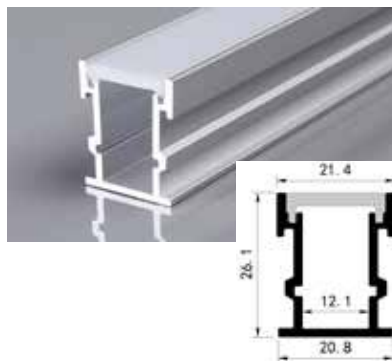

Προφίλ Χωνευτό 2m
Profile Recessed 2m



Info 18W/M Max • Material Πλαστικό - Αλουμίνιο / Plastic - Aluminium

| Code | Barcode | Packing | MOQ |
|-----------|---------------|---------|-----|
| 145-70916 | 5207227160356 | 1/90 | 1 |

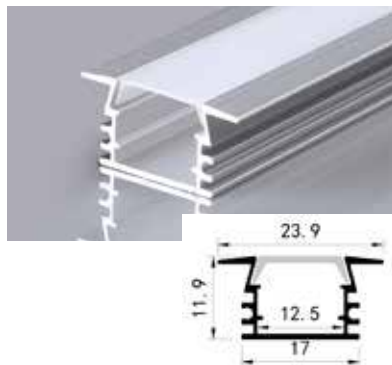

Προφίλ Χωνευτό 2m
Profile Recessed 2m



Material Πλαστικό - Αλουμίνιο / Plastic - Aluminium

| Code | Barcode | Packing | MOQ |
|-----------|---------------|---------|-----|
| 145-70956 | 5207227434891 | 1/24 | 1 |

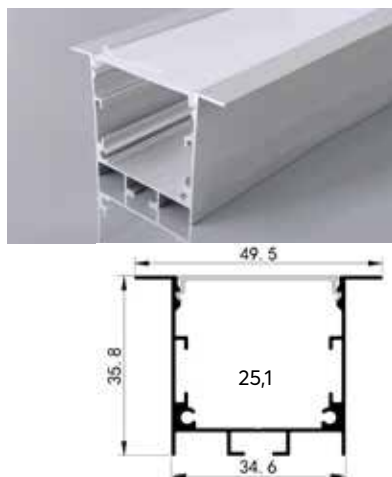

Προφίλ Χωνευτό Γυψοσανίδας 2m
Profile Recessed for Plasterboard 2m



Info 18W/M Max • Material Πλαστικό - Αλουμίνιο / Plastic - Aluminium

| Code | Barcode | Packing | MOQ |
|-----------|---------------|---------|-----|
| 145-70920 | 5207227159589 | 1/40 | 1 |

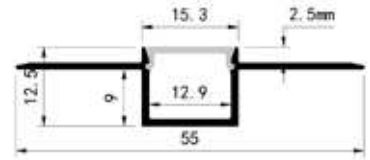

Προφίλ Χωνευτό Γυψοσανίδας 2m
Profile Recessed for Plasterboard 2m



Info 18W/M Max • Material Πλαστικό - Αλουμίνιο / Plastic - Aluminium

| Code | Barcode | Packing | MOQ |
|-----------|---------------|---------|-----|
| 145-70921 | 5207227159596 | 1/40 | 1 |

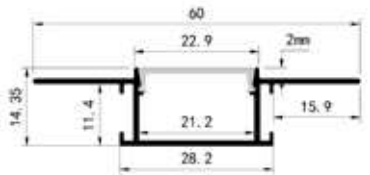

Προφίλ Χωνευτό Γυψοσανίδας 2m
Profile Recessed for Plasterboard 2m



Info 18W/M Max • Material Πλαστικό - Αλουμίνιο / Plastic - Aluminium

| Code | Barcode | Packing | MOQ |
|-----------|---------------|---------|-----|
| 145-70922 | 5207227159602 | 1/40 | 1 |

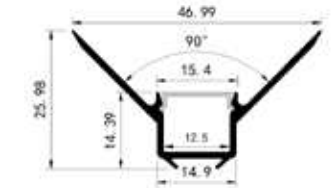
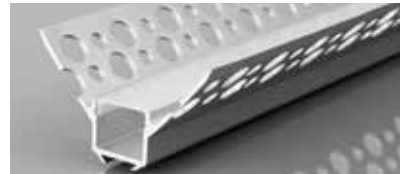

Προφίλ Χωνευτό Γυψοσανίδας 2m
Profile Recessed for Plasterboard 2m



Info 18W/M Max • Material Πλαστικό - Αλουμίνιο / Plastic - Aluminium

| Code | Barcode | Packing | MOQ |
|-----------|---------------|---------|-----|
| 145-70923 | 5207227159619 | 1/40 | 1 |

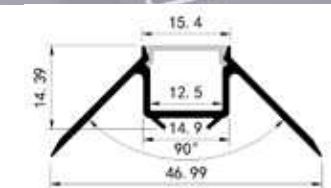

Προφίλ Χωνευτό Γυψοσανίδας 2m
Profile Recessed for Plasterboard 2m



Material Πλαστικό - Αλουμίνιο / Plastic - Aluminium

| Code | Barcode | Packing | MOQ |
|-----------|---------------|---------|-----|
| 145-70957 | 5207227434914 | 1/60 | 1 |

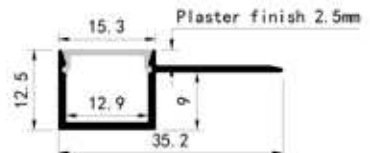

Προφίλ Χωνευτό Γυψοσανίδας 2m
Profile Recessed for Plasterboard 2m



Material Πλαστικό - Αλουμίνιο / Plastic - Aluminium

| Code | Barcode | Packing | MOQ |
|-----------|---------------|---------|-----|
| 145-70958 | 5207227434938 | 1/40 | 1 |

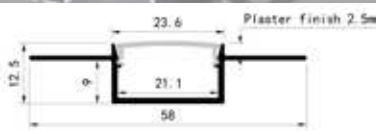

Προφίλ Χωνευτό Flex Γυψοσανίδας 2m
Profile Recessed Flex for Plasterboard 2m



Material Πλαστικό - Αλουμίνιο / Plastic - Aluminium

| Code | Barcode | Packing | MOQ |
|-----------|---------------|---------|-----|
| 145-70959 | 5207227434952 | 1/40 | 1 |

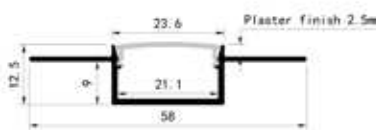

Προφίλ Χωνευτό Γυψοσανίδας 2m
Profile Recessed for Plasterboard 2m

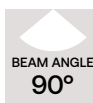

Material Πλαστικό - Αλουμίνιο / Plastic - Aluminium

| Code | Barcode | Packing | MOQ |
|-----------|---------------|---------|-----|
| 145-70960 | 5207227434976 | 1/40 | 1 |

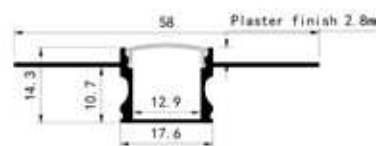
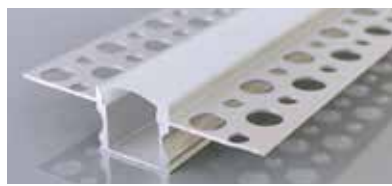

Προφίλ Εξωτερικό Κρυφού Φωτισμού 2m
Profile External Hidden Lighting 2m



Material Πλαστικό - Αλουμίνιο / Plastic - Aluminium

| Code | Barcode | Packing | MOQ |
|-----------|---------------|---------|-----|
| 145-70918 | 5207227248344 | 1/40 | 1 |



Προφίλ Εξωτερικό Κρυφού Φωτισμού 2m
Profile External Hidden Lighting 2m



Material Πλαστικό - Αλουμίνιο / Plastic - Aluminium

| Code | Barcode | Packing | MOQ |
|-----------|---------------|---------|-----|
| 145-70919 | 5207227248351 | 1/24 | 1 |

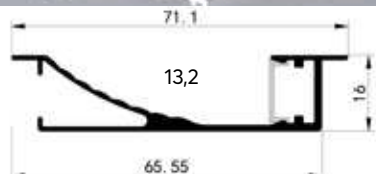

Προφίλ Δαπέδου Οβάλ 2m
Floor Profile Oval 2m



Info 18W/M Max • Material Πλαστικό - Αλουμίνιο / Plastic - Aluminium

| Code | Barcode | Packing | MOQ |
|-----------|---------------|---------|-----|
| 145-70911 | 5207227159541 | 1/60 | 1 |

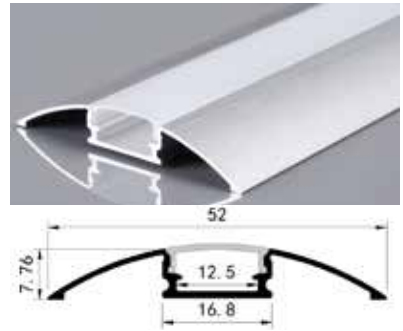

Προφίλ Δαπέδου Εξωτερικό 2m
Floor Profile External 2m



Material Πλαστικό - Αλουμίνιο / Plastic - Aluminium

| Code | Barcode | Packing | MOQ |
|-----------|---------------|---------|-----|
| 145-70926 | 5207227248375 | 1/60 | 1 |

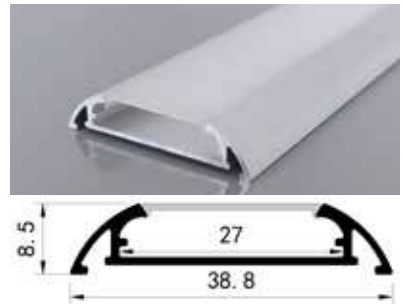

Προφίλ Εξωτερικό Οβάλ 2m
Profile External Oval 2m



Info 18W/M Max • Material Πλαστικό - Αλουμίνιο / Plastic - Aluminium

| Code | Barcode | Packing | MOQ |
|-----------|---------|---------|-----|
| 145-70940 | | 1/50 | 1 |

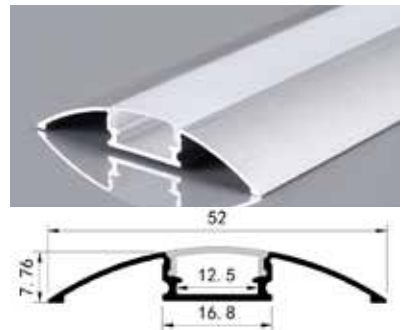

Προφίλ Δαπέδου Εξωτερικό 2m
Floor Profile External 2m



Material Πλαστικό - Αλουμίνιο / Plastic - Aluminium

| Code | Barcode | Packing | MOQ |
|-----------|---------------|---------|-----|
| 145-70961 | 5207227434990 | 1/20 | 1 |

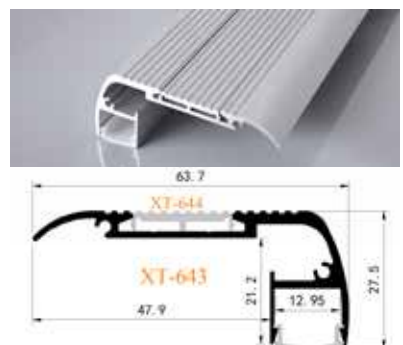

Προφίλ Δαπέδου Εξωτερικό 2m
Floor Profile External 2m



Material Πλαστικό - Αλουμίνιο / Plastic - Aluminium

| Code | Barcode | Packing | MOQ |
|-----------|---------------|---------|-----|
| 145-70962 | 5207227435010 | 1/24 | 1 |

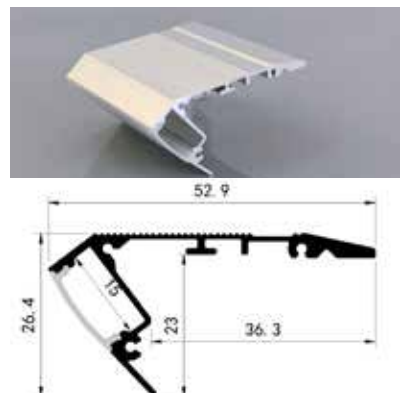

Προφίλ Δαπέδου Εξωτερικό 2m
Floor Profile External 2m

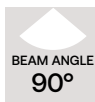

Material Πλαστικό - Αλουμίνιο / Plastic - Aluminium

| Code | Barcode | Packing | MOQ |
|-----------|---------------|---------|-----|
| 145-70963 | 5207227434792 | 1/24 | 1 |

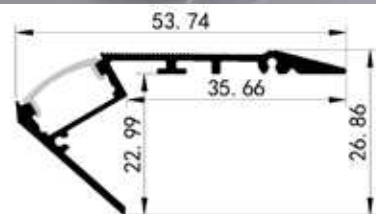

Προφίλ Εξωτερικό Σοβά Ντεπί 2m
Profile External Depi Plaster 2m

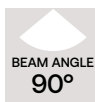

Material Πλαστικό - Αλουμίνιο / Plastic - Aluminium

| Code | Barcode | Packing | MOQ |
|-----------|---------------|---------|-----|
| 145-70964 | 5207227435072 | 1/20 | 1 |

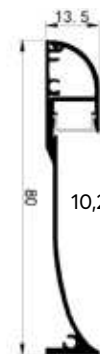

Εξάρτημα για Σοβά Ντεπί Γωνία Εσωτερική
Accessory for Plaster Depi Internal Corner

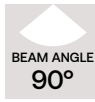

Material Πλαστικό - Αλουμίνιο / Plastic - Aluminium

| Code | Barcode | Packing | MOQ |
|-----------|---------------|---------|-----|
| 145-70965 | 5207227435034 | 1/500 | 1 |



L×W×H [mm]
80 x 20 x 15

Εξάρτημα για Σοβά Ντεπί Γωνία Εσωτερική
Accessory for Plaster Depi Internal Corner

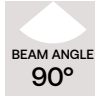

Material Πλαστικό - Αλουμίνιο / Plastic - Aluminium

| Code | Barcode | Packing | MOQ |
|-----------|---------------|---------|-----|
| 145-70966 | 5207227435058 | 1/500 | 1 |



L×W×H [mm]
80 x 20 x 15

Προφίλ Εξωτερικό Up-Down 2m
Profile External Up-Down 2m

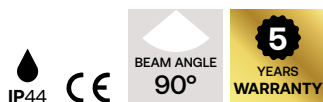

Material Πλαστικό - Αλουμίνιο / Plastic - Aluminium

| Code | Barcode | Packing | MOQ |
|-----------|---------------|---------|-----|
| 145-70917 | 5207227248337 | 1/20 | 1 |

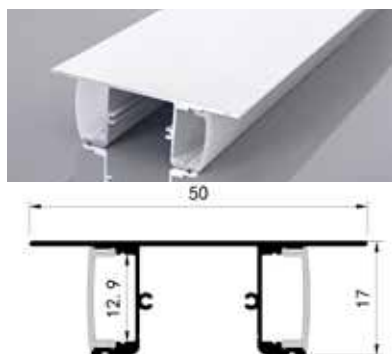

Προφίλ Εξωτερικό Up-Down 2m
Profile External Up-Down 2m

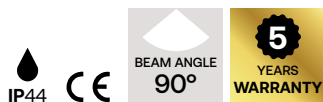

Material Πλαστικό - Αλουμίνιο / Plastic - Aluminium

| Code | Barcode | Packing | MOQ |
|-----------|---------------|---------|-----|
| 145-70925 | 5207227248368 | 1/4 | 1 |

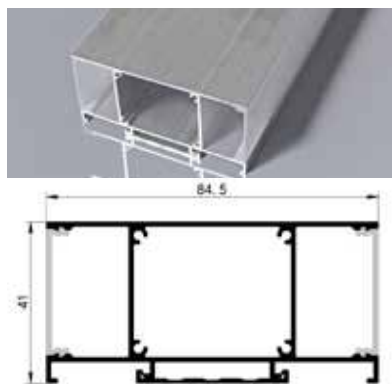

Προφίλ Μεταλλικό FLEX 6mm (5m) 2m
Metal Profile FLEX 6mm (5m) 2m

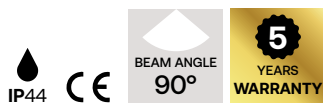

Material Πλαστικό - Αλουμίνιο / Plastic - Aluminium

| Code | Barcode | Packing | MOQ |
|-----------|---------------|---------|-----|
| 145-70930 | 5207227258114 | 1/100 | 1 |

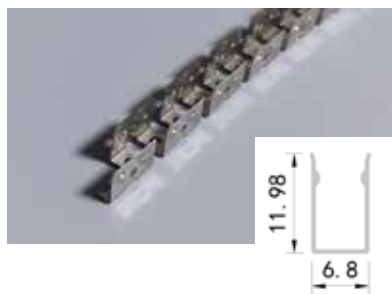

Προφίλ Μεταλλικό FLEX 8mm (5m) 2m
Metal Profile FLEX 8mm (5m) 2m

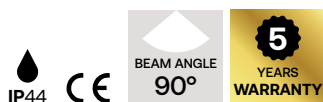

Material Πλαστικό - Αλουμίνιο / Plastic - Aluminium

| Code | Barcode | Packing | MOQ |
|-----------|---------------|---------|-----|
| 145-70931 | 5207227258121 | 1/100 | 1 |

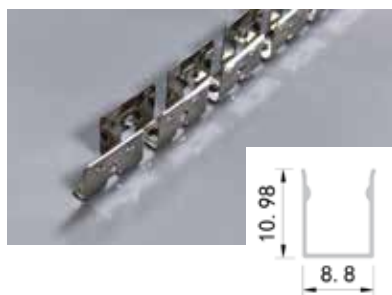

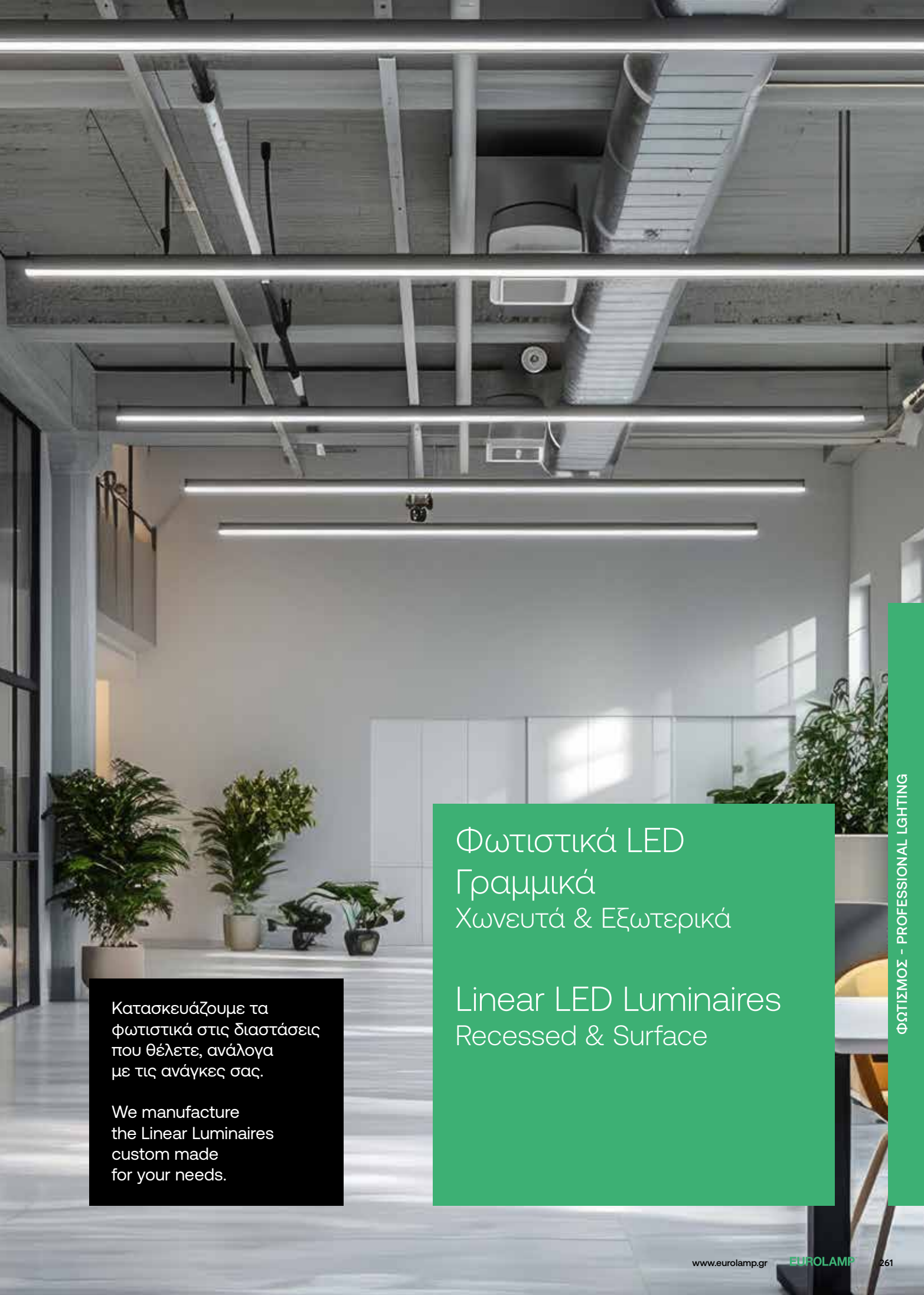

Κατασκευάζουμε τα φωτιστικά στις διαστάσεις που θέλετε, ανάλογα με τις ανάγκες σας.

We manufacture the Linear Luminaires custom made for your needs.

Φωτιστικά LED
Γραμμικά
Χωνευτά & Εξωτερικά

Linear LED Luminaires
Recessed & Surface



Ποικιλία χρωμάτων
Variety of colors



Δυνατότητα ειδικών διαστάσεων
Available in custom sizes



2-5m
Installation Height

Δυνατότητα διαχείρισης
Manageability

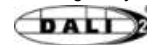

FLICKER FREE



50.000h



ON OFF



IP40



CLASS II



IK08



CE



E



130 lm/W 50X30

Volt 220-240V 50/60Hz • LED Type SMD2835 • Chip Brand Lumileds

Start Time 0,5 sec • PF >95 • Operating Temperature -20°C / +40°C

Connection Καλώδιο / Wire

Material Αλουμίνιο & Πλαστικό / Aluminium & Plastic

| | | | | |
|-----------------------------|------------------|--------------------|--------------|------------------|
| LUMEN / WATT lm/W 130 | CRI Ra >80 | BEAM ANGLE 120° | NON DIMMABLE | 5 YEARS WARRANTY |
|-----------------------------|------------------|--------------------|--------------|------------------|

| Code | Barcode | Watt | Kelvin | Dimension (mm) | | | Cutting Dimension (mm) | Weight (kg) | Color | Packing | MOQ |
|-----------|---------------|------|--------|----------------|----|----|------------------------|-------------|-------|---------|-----|
| | | | | ↗ | ↔ | ↘ | | | | | |
| 145-50240 | 5207227452734 | 18 | 6500 | 400 | 50 | 30 | 400X50 | 0.454 | WHITE | 1 | 1 |
| 145-50241 | 5207227452741 | 18 | 4000 | 400 | 50 | 30 | 400X50 | 0.454 | WHITE | 1 | 1 |
| 145-50242 | 5207227452758 | 18 | 3000 | 400 | 50 | 30 | 400X50 | 0.454 | WHITE | 1 | 1 |
| 145-50243 | 5207227452765 | 18 | 6500 | 400 | 50 | 30 | 400X50 | 0.454 | BLACK | 1 | 1 |
| 145-50244 | 5207227452772 | 18 | 4000 | 400 | 50 | 30 | 400X50 | 0.454 | BLACK | 1 | 1 |
| 145-50245 | 5207227452789 | 18 | 3000 | 400 | 50 | 30 | 400X50 | 0.454 | BLACK | 1 | 1 |

| Code | Barcode | Watt | Kelvin | Dimension (mm) | | | Cutting Dimension (mm) | Weight (kg) | Color | Packing | MOQ |
|-----------|---------------|------|--------|----------------|----|----|------------------------|-------------|-------|---------|-----|
| | | | | ↗ | ↔ | ↘ | | | | | |
| 145-50250 | 5207227452796 | 27 | 6500 | 600 | 50 | 30 | 600X50 | 0.681 | WHITE | 1 | 1 |
| 145-50251 | 5207227452802 | 27 | 4000 | 600 | 50 | 30 | 600X50 | 0.681 | WHITE | 1 | 1 |
| 145-50252 | 5207227452819 | 27 | 3000 | 600 | 50 | 30 | 600X50 | 0.681 | WHITE | 1 | 1 |
| 145-50253 | 5207227452826 | 27 | 6500 | 600 | 50 | 30 | 600X50 | 0.681 | BLACK | 1 | 1 |
| 145-50254 | 5207227452833 | 27 | 4000 | 600 | 50 | 30 | 600X50 | 0.681 | BLACK | 1 | 1 |
| 145-50255 | 5207227452840 | 27 | 3000 | 600 | 50 | 30 | 600X50 | 0.681 | BLACK | 1 | 1 |

| Code | Barcode | Watt | Kelvin | Dimension (mm) | | | Cutting Dimension (mm) | Weight (kg) | Color | Packing | MOQ |
|-----------|---------------|------|--------|----------------|----|----|------------------------|-------------|-------|---------|-----|
| | | | | ↗ | ↔ | ↘ | | | | | |
| 145-50260 | 5207227452857 | 36 | 6500 | 800 | 50 | 30 | 800X50 | 0.908 | WHITE | 1 | 1 |
| 145-50261 | 5207227452864 | 36 | 4000 | 800 | 50 | 30 | 800X50 | 0.908 | WHITE | 1 | 1 |
| 145-50262 | 5207227452871 | 36 | 3000 | 800 | 50 | 30 | 800X50 | 0.908 | WHITE | 1 | 1 |
| 145-50263 | 5207227452888 | 36 | 6500 | 800 | 50 | 30 | 800X50 | 0.908 | BLACK | 1 | 1 |
| 145-50264 | 5207227452895 | 36 | 4000 | 800 | 50 | 30 | 800X50 | 0.908 | BLACK | 1 | 1 |
| 145-50265 | 5207227452901 | 36 | 3000 | 800 | 50 | 30 | 800X50 | 0.908 | BLACK | 1 | 1 |

| Code | Barcode | Watt | Kelvin | Dimension (mm) | | | Cutting Dimension (mm) | Weight (kg) | Color | Packing | MOQ |
|-----------|---------------|------|--------|----------------|----|----|------------------------|-------------|-------|---------|-----|
| | | | | ↗ | ↔ | ↘ | | | | | |
| 145-50100 | 5207227303043 | 40 | 6500 | 1000 | 50 | 30 | 1000X50 | 1.135 | WHITE | 1 | 1 |
| 145-50101 | 5207227303050 | 40 | 4000 | 1000 | 50 | 30 | 1000X50 | 1.135 | WHITE | 1 | 1 |
| 145-50102 | 5207227303067 | 40 | 3000 | 1000 | 50 | 30 | 1000X50 | 1.135 | WHITE | 1 | 1 |
| 145-50103 | 5207227303074 | 40 | 6500 | 1000 | 50 | 30 | 1000X50 | 1.135 | BLACK | 1 | 1 |
| 145-50104 | 5207227303081 | 40 | 4000 | 1000 | 50 | 30 | 1000X50 | 1.135 | BLACK | 1 | 1 |
| 145-50105 | 5207227303098 | 40 | 3000 | 1000 | 50 | 30 | 1000X50 | 1.135 | BLACK | 1 | 1 |



| Code | Barcode | Watt | Kelvin | Dimension (mm) | | | Cutting Dimension (mm) | Weight (kg) | Color | Packing | MOQ |
|-----------|---------------|------|--------|----------------|----|----|------------------------|-------------|-------|---------|-----|
| | | | | ↗ | ↔ | ↘ | | | | | |
| 145-50110 | 5207227303104 | 48 | 6500 | 1200 | 50 | 30 | 1200x50 | 1.358 | WHITE | 1 | 1 |
| 145-50111 | 5207227303111 | 48 | 4000 | 1200 | 50 | 30 | 1200x50 | 1.358 | WHITE | 1 | 1 |
| 145-50112 | 5207227303128 | 48 | 3000 | 1200 | 50 | 30 | 1200x50 | 1.358 | WHITE | 1 | 1 |
| 145-50113 | 5207227303135 | 48 | 6500 | 1200 | 50 | 30 | 1200x50 | 1.358 | BLACK | 1 | 1 |
| 145-50114 | 5207227303142 | 48 | 4000 | 1200 | 50 | 30 | 1200x50 | 1.358 | BLACK | 1 | 1 |
| 145-50115 | 5207227303159 | 48 | 3000 | 1200 | 50 | 30 | 1200x50 | 1.358 | BLACK | 1 | 1 |

| Code | Barcode | Watt | Kelvin | Dimension (mm) | | | Cutting Dimension (mm) | Weight (kg) | Color | Packing | MOQ |
|-----------|---------------|------|--------|----------------|----|----|------------------------|-------------|-------|---------|-----|
| | | | | ↗ | ↔ | ↘ | | | | | |
| 145-50120 | 5207227303166 | 60 | 6500 | 1500 | 50 | 30 | 1500x50 | 1.635 | WHITE | 1 | 1 |
| 145-50121 | 5207227303173 | 60 | 4000 | 1500 | 50 | 30 | 1500x50 | 1.635 | WHITE | 1 | 1 |
| 145-50122 | 5207227303180 | 60 | 3000 | 1500 | 50 | 30 | 1500x50 | 1.635 | WHITE | 1 | 1 |
| 145-50123 | 5207227303197 | 60 | 6500 | 1500 | 50 | 30 | 1500x50 | 1.635 | BLACK | 1 | 1 |
| 145-50124 | 5207227303203 | 60 | 4000 | 1500 | 50 | 30 | 1500x50 | 1.635 | BLACK | 1 | 1 |
| 145-50125 | 5207227303210 | 60 | 3000 | 1500 | 50 | 30 | 1500x50 | 1.635 | BLACK | 1 | 1 |

| Code | Barcode | Watt | Kelvin | Dimension (mm) | | | Cutting Dimension (mm) | Weight (kg) | Color | Packing | MOQ |
|-----------|---------------|------|--------|----------------|----|----|------------------------|-------------|-------|---------|-----|
| | | | | ↗ | ↔ | ↘ | | | | | |
| 145-50130 | 5207227303227 | 80 | 6500 | 2000 | 50 | 30 | 2000x50 | 2.205 | WHITE | 1 | 1 |
| 145-50131 | 5207227303234 | 80 | 4000 | 2000 | 50 | 30 | 2000x50 | 2.205 | WHITE | 1 | 1 |
| 145-50132 | 5207227303241 | 80 | 3000 | 2000 | 50 | 30 | 2000x50 | 2.205 | WHITE | 1 | 1 |
| 145-50133 | 5207227303258 | 80 | 6500 | 2000 | 50 | 30 | 2000x50 | 2.205 | BLACK | 1 | 1 |
| 145-50134 | 5207227303265 | 80 | 4000 | 2000 | 50 | 30 | 2000x50 | 2.205 | BLACK | 1 | 1 |
| 145-50135 | 5207227303272 | 80 | 3000 | 2000 | 50 | 30 | 2000x50 | 2.205 | BLACK | 1 | 1 |



180 lm/W 50X30



Ποικιλία χρωμάτων
Variety of colors



Δυνατότητα ειδικών διαστάσεων
Available in custom sizes

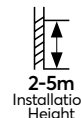

Δυνατότητα διαχείρισης
Manageability

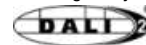

Volt 220-240V 50/60Hz • LED Type SMD2835 • Chip Brand Lumileds

Start Time 0,5 sec • PF >95 • Operating Temperature -20°C / +40°C

Connection Καλώδιο / Wire

Material Αλουμίνιο & Πλαστικό / Aluminium & Plastic

| | | | | |
|-----------------------------|------------------|--------------------|--------------|------------------|
| LUMEN / WATT lm/W 180 | CRI Ra >80 | BEAM ANGLE 120° | NON DIMMABLE | 5 YEARS WARRANTY |
|-----------------------------|------------------|--------------------|--------------|------------------|

| Code | Barcode | Watt | Kelvin | Dimension (mm) | | | Cutting Dimension (mm) | Weight (kg) | Color | Packing | MOQ |
|-----------|---------------|------|--------|----------------|----|----|------------------------|-------------|-------|---------|-----|
| | | | | ↕ | ↔ | ↕ | | | | | |
| 145-50300 | 5207227453038 | 15 | 6500 | 400 | 50 | 30 | 400X50 | 0.454 | WHITE | 1 | 1 |
| 145-50301 | 5207227453045 | 15 | 4000 | 400 | 50 | 30 | 400X50 | 0.454 | WHITE | 1 | 1 |
| 145-50302 | 5207227453052 | 15 | 3000 | 400 | 50 | 30 | 400X50 | 0.454 | WHITE | 1 | 1 |
| 145-50303 | 5207227453069 | 15 | 6500 | 400 | 50 | 30 | 400X50 | 0.454 | BLACK | 1 | 1 |
| 145-50304 | 5207227453076 | 15 | 4000 | 400 | 50 | 30 | 400X50 | 0.454 | BLACK | 1 | 1 |
| 145-50305 | 5207227453083 | 15 | 3000 | 400 | 50 | 30 | 400X50 | 0.454 | BLACK | 1 | 1 |

| Code | Barcode | Watt | Kelvin | Dimension (mm) | | | Cutting Dimension (mm) | Weight (kg) | Color | Packing | MOQ |
|-----------|---------------|------|--------|----------------|----|----|------------------------|-------------|-------|---------|-----|
| | | | | ↕ | ↔ | ↕ | | | | | |
| 145-50310 | 5207227453090 | 21,5 | 6500 | 600 | 50 | 30 | 600X50 | 0.681 | WHITE | 1 | 1 |
| 145-50311 | 5207227453106 | 21,5 | 4000 | 600 | 50 | 30 | 600X50 | 0.681 | WHITE | 1 | 1 |
| 145-50312 | 5207227453113 | 21,5 | 3000 | 600 | 50 | 30 | 600X50 | 0.681 | WHITE | 1 | 1 |
| 145-50313 | 5207227453120 | 21,5 | 6500 | 600 | 50 | 30 | 600X50 | 0.681 | BLACK | 1 | 1 |
| 145-50314 | 5207227453137 | 21,5 | 4000 | 600 | 50 | 30 | 600X50 | 0.681 | BLACK | 1 | 1 |
| 145-50315 | 5207227453144 | 21,5 | 3000 | 600 | 50 | 30 | 600X50 | 0.681 | BLACK | 1 | 1 |

| Code | Barcode | Watt | Kelvin | Dimension (mm) | | | Cutting Dimension (mm) | Weight (kg) | Color | Packing | MOQ |
|-----------|---------------|------|--------|----------------|----|----|------------------------|-------------|-------|---------|-----|
| | | | | ↕ | ↔ | ↕ | | | | | |
| 145-50320 | 5207227453151 | 29 | 6500 | 800 | 50 | 30 | 800X50 | 0.908 | WHITE | 1 | 1 |
| 145-50321 | 5207227453168 | 29 | 4000 | 800 | 50 | 30 | 800X50 | 0.908 | WHITE | 1 | 1 |
| 145-50322 | 5207227453175 | 29 | 3000 | 800 | 50 | 30 | 800X50 | 0.908 | WHITE | 1 | 1 |
| 145-50323 | 5207227453182 | 29 | 6500 | 800 | 50 | 30 | 800X50 | 0.908 | BLACK | 1 | 1 |
| 145-50324 | 5207227453199 | 29 | 4000 | 800 | 50 | 30 | 800X50 | 0.908 | BLACK | 1 | 1 |
| 145-50325 | 5207227453205 | 29 | 3000 | 800 | 50 | 30 | 800X50 | 0.908 | BLACK | 1 | 1 |

| Code | Barcode | Watt | Kelvin | Dimension (mm) | | | Cutting Dimension (mm) | Weight (kg) | Color | Packing | MOQ |
|-----------|---------------|------|--------|----------------|----|----|------------------------|-------------|-------|---------|-----|
| | | | | ↕ | ↔ | ↕ | | | | | |
| 145-50200 | 5207227303289 | 37,5 | 6500 | 1000 | 50 | 30 | 1000X50 | 1.135 | WHITE | 1 | 1 |
| 145-50201 | 5207227303296 | 37,5 | 4000 | 1000 | 50 | 30 | 1000X50 | 1.135 | WHITE | 1 | 1 |
| 145-50202 | 5207227303302 | 37,5 | 3000 | 1000 | 50 | 30 | 1000X50 | 1.135 | WHITE | 1 | 1 |
| 145-50203 | 5207227303319 | 37,5 | 6500 | 1000 | 50 | 30 | 1000X50 | 1.135 | BLACK | 1 | 1 |
| 145-50204 | 5207227303326 | 37,5 | 4000 | 1000 | 50 | 30 | 1000X50 | 1.135 | BLACK | 1 | 1 |
| 145-50205 | 5207227303333 | 37,5 | 3000 | 1000 | 50 | 30 | 1000X50 | 1.135 | BLACK | 1 | 1 |



| Code | Barcode | Watt | Kelvin | Dimension (mm) | | | Cutting Dimension (mm) | Weight (kg) | Color | Packing | MOQ |
|-----------|---------------|------|--------|----------------|----|----|------------------------|-------------|-------|---------|-----|
| | | | | ↗ | ↔ | ↘ | | | | | |
| 145-50210 | 5207227303340 | 43,2 | 6500 | 1200 | 50 | 30 | 1200x50 | 1.358 | WHITE | 1 | 1 |
| 145-50211 | 5207227303357 | 43,2 | 4000 | 1200 | 50 | 30 | 1200x50 | 1.358 | WHITE | 1 | 1 |
| 145-50212 | 5207227303364 | 43,2 | 3000 | 1200 | 50 | 30 | 1200x50 | 1.358 | WHITE | 1 | 1 |
| 145-50213 | 5207227303371 | 43,2 | 6500 | 1200 | 50 | 30 | 1200x50 | 1.358 | BLACK | 1 | 1 |
| 145-50214 | 5207227303388 | 43,2 | 4000 | 1200 | 50 | 30 | 1200x50 | 1.358 | BLACK | 1 | 1 |
| 145-50215 | 5207227303395 | 43,2 | 3000 | 1200 | 50 | 30 | 1200x50 | 1.358 | BLACK | 1 | 1 |

| Code | Barcode | Watt | Kelvin | Dimension (mm) | | | Cutting Dimension (mm) | Weight (kg) | Color | Packing | MOQ |
|-----------|---------------|------|--------|----------------|----|----|------------------------|-------------|-------|---------|-----|
| | | | | ↗ | ↔ | ↘ | | | | | |
| 145-50220 | 5207227303401 | 51,7 | 6500 | 1500 | 50 | 30 | 1500x50 | 1.635 | WHITE | 1 | 1 |
| 145-50221 | 5207227303418 | 51,7 | 4000 | 1500 | 50 | 30 | 1500x50 | 1.635 | WHITE | 1 | 1 |
| 145-50222 | 5207227303425 | 51,7 | 3000 | 1500 | 50 | 30 | 1500x50 | 1.635 | WHITE | 1 | 1 |
| 145-50223 | 5207227303432 | 51,7 | 6500 | 1500 | 50 | 30 | 1500x50 | 1.635 | BLACK | 1 | 1 |
| 145-50224 | 5207227303449 | 51,7 | 4000 | 1500 | 50 | 30 | 1500x50 | 1.635 | BLACK | 1 | 1 |
| 145-50225 | 5207227303456 | 51,7 | 3000 | 1500 | 50 | 30 | 1500x50 | 1.635 | BLACK | 1 | 1 |

| Code | Barcode | Watt | Kelvin | Dimension (mm) | | | Cutting Dimension (mm) | Weight (kg) | Color | Packing | MOQ |
|-----------|---------------|------|--------|----------------|----|----|------------------------|-------------|-------|---------|-----|
| | | | | ↗ | ↔ | ↘ | | | | | |
| 145-50230 | 5207227303463 | 71,4 | 6500 | 2000 | 50 | 30 | 2000x50 | 2.205 | WHITE | 1 | 1 |
| 145-50231 | 5207227303470 | 71,4 | 4000 | 2000 | 50 | 30 | 2000x50 | 2.205 | WHITE | 1 | 1 |
| 145-50232 | 5207227303487 | 71,4 | 3000 | 2000 | 50 | 30 | 2000x50 | 2.205 | WHITE | 1 | 1 |
| 145-50233 | 5207227303494 | 71,4 | 6500 | 2000 | 50 | 30 | 2000x50 | 2.205 | BLACK | 1 | 1 |
| 145-50234 | 5207227303500 | 71,4 | 4000 | 2000 | 50 | 30 | 2000x50 | 2.205 | BLACK | 1 | 1 |
| 145-50235 | 5207227303517 | 71,4 | 3000 | 2000 | 50 | 30 | 2000x50 | 2.205 | BLACK | 1 | 1 |



180 lm/W Γωνία - Corner



Ποικιλία
χρωμάτων
Variety
of colors



Δυνατότητα
ειδικών διαστάσεων
Available in
custom sizes

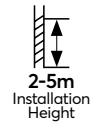

Δυνατότητα διαχείρισης
Manageability



LIFUD
LED Driver



FLICKER
FREE



50.000h



ON
OFF



IP40



CLASS II



IK08



CE



Green arrow icon



Volt 220-240V 50/60Hz • LED Type SMD2835 • Chip Brand Lumileds

Start Time 0,5 sec • PF >95 • Operating Temperature -20°C / +40°C

Connection Καλώδιο / Wire

Material Αλουμίνιο & Πλαστικό / Aluminium & Plastic

LUMEN / WATT
lm/W
180

CRI
Ra
>80

BEAM ANGLE
120°

NON
DIMMABLE

5
YEARS
WARRANTY

| Code | Barcode | Watt | Kelvin | Dimension ∅ (mm) ↔ | Cutting Dimension (mm) | Weight (kg) | Color | Packing | MOQ |
|-----------|---------------|------|--------|-----------------------|---------------------------|----------------|-------|---------|-----|
| 145-50280 | 5207227452970 | 71,4 | 6500 | 1000 x 1000 | 2*(1000x50) | 2.270 | WHITE | 1 | 1 |
| 145-50281 | 5207227452987 | 71,4 | 4000 | 1000 x 1000 | 2*(1000x50) | 2.270 | WHITE | 1 | 1 |
| 145-50282 | 5207227452994 | 71,4 | 3000 | 1000 x 1000 | 2*(1000x50) | 2.270 | WHITE | 1 | 1 |



180 lm/W Τετράγωνο - Square

| Code | Barcode | Watt | Kelvin | Dimension ∅ (mm) ↔ | Cutting Dimension (mm) | Weight (kg) | Color | Packing | MOQ |
|-----------|---------------|-------|--------|-----------------------|---------------------------|----------------|-------|---------|-----|
| 145-50270 | 5207227452918 | 142,8 | 6500 | 1000 x 1000 | 4*(1000x50) | 4.540 | WHITE | 1 | 1 |
| 145-50271 | 5207227452925 | 142,8 | 4000 | 1000 x 1000 | 4*(1000x50) | 4.540 | WHITE | 1 | 1 |
| 145-50272 | 5207227452932 | 142,8 | 3000 | 1000 x 1000 | 4*(1000x50) | 4.540 | WHITE | 1 | 1 |
| 145-50273 | 5207227452949 | 172,8 | 6500 | 1000 x 1000 | 4*(1000x50) | 4.540 | WHITE | 1 | 1 |
| 145-50274 | 5207227452956 | 172,8 | 4000 | 1000 x 1000 | 4*(1000x50) | 4.540 | WHITE | 1 | 1 |
| 145-50275 | 5207227452963 | 172,8 | 3000 | 1000 x 1000 | 4*(1000x50) | 4.540 | WHITE | 1 | 1 |



180 lm/W Σχήμα "Π" - Shape "Π"

| Code | Barcode | Watt | Kelvin | Dimension ∅ (mm) ↔ | Cutting Dimension (mm) | Weight (kg) | Color | Packing | MOQ |
|-----------|---------------|------|--------|-----------------------|---------------------------|----------------|-------|---------|-----|
| 145-50290 | 5207227453007 | 95 | 6500 | 1000 x 1000 | 3*(1000x50) | 3.405 | WHITE | 1 | 1 |
| 145-50291 | 5207227453014 | 95 | 4000 | 1000 x 1000 | 3*(1000x50) | 3.405 | WHITE | 1 | 1 |
| 145-50292 | 5207227453021 | 95 | 3000 | 1000 x 1000 | 3*(1000x50) | 3.405 | WHITE | 1 | 1 |





Ποικιλία χρωμάτων
Variety of colors



Δυνατότητα ειδικών διαστάσεων
Available in custom sizes

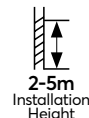

Δυνατότητα διαχείρισης
Manageability

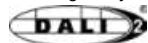

FLICKER FREE



50.000h



ON OFF



IP40



CLASS II



IK08



CE



E



130 lm/W 65X45

Volt 220-240V 50/60Hz • LED Type SMD2835 • Chip Brand Lumileds

Start Time 0,5 sec • PF >95 • Operating Temperature -20°C / +40°C

Connection Καλώδιο / Wire

Material Αλουμίνιο & Πλαστικό / Aluminium & Plastic

| | | | | |
|-----------------------------|------------------|--------------------|--------------|------------------|
| LUMEN / WATT lm/W 130 | CRI Ra >80 | BEAM ANGLE 120° | NON DIMMABLE | 5 YEARS WARRANTY |
|-----------------------------|------------------|--------------------|--------------|------------------|

| Code | Barcode | Watt | Kelvin | Dimension (mm) | | | Weight (kg) | Color | Packing | MOQ |
|-----------|---------------|------|--------|----------------|----|----|-------------|-------|---------|-----|
| | | | | ↕ | ↔ | ↕ | | | | |
| 145-50450 | 5207227453212 | 18 | 6500 | 400 | 45 | 65 | 0.454 | WHITE | 1 | 1 |
| 145-50451 | 5207227453229 | 18 | 4000 | 400 | 45 | 65 | 0.454 | WHITE | 1 | 1 |
| 145-50452 | 5207227453236 | 18 | 3000 | 400 | 45 | 65 | 0.454 | WHITE | 1 | 1 |
| 145-50453 | 5207227453243 | 18 | 6500 | 400 | 45 | 65 | 0.454 | BLACK | 1 | 1 |
| 145-50454 | 5207227453250 | 18 | 4000 | 400 | 45 | 65 | 0.454 | BLACK | 1 | 1 |
| 145-50455 | 5207227453267 | 18 | 3000 | 400 | 45 | 65 | 0.454 | BLACK | 1 | 1 |

| Code | Barcode | Watt | Kelvin | Dimension (mm) | | | Weight (kg) | Color | Packing | MOQ |
|-----------|---------------|------|--------|----------------|----|----|-------------|-------|---------|-----|
| | | | | ↕ | ↔ | ↕ | | | | |
| 145-50456 | 5207227453274 | 27 | 6500 | 600 | 45 | 65 | 0.681 | WHITE | 1 | 1 |
| 145-50457 | 5207227453281 | 27 | 4000 | 600 | 45 | 65 | 0.681 | WHITE | 1 | 1 |
| 145-50458 | 5207227453298 | 27 | 3000 | 600 | 45 | 65 | 0.681 | WHITE | 1 | 1 |
| 145-50459 | 5207227453304 | 27 | 6500 | 600 | 45 | 65 | 0.681 | BLACK | 1 | 1 |
| 145-50460 | 5207227453311 | 27 | 4000 | 600 | 45 | 65 | 0.681 | BLACK | 1 | 1 |
| 145-50461 | 5207227453328 | 27 | 3000 | 600 | 45 | 65 | 0.681 | BLACK | 1 | 1 |

| Code | Barcode | Watt | Kelvin | Dimension (mm) | | | Weight (kg) | Color | Packing | MOQ |
|-----------|---------------|------|--------|----------------|----|----|-------------|-------|---------|-----|
| | | | | ↕ | ↔ | ↕ | | | | |
| 145-50462 | 5207227453335 | 36 | 6500 | 800 | 45 | 65 | 0.908 | WHITE | 1 | 1 |
| 145-50463 | 5207227453342 | 36 | 4000 | 800 | 45 | 65 | 0.908 | WHITE | 1 | 1 |
| 145-50464 | 5207227453359 | 36 | 3000 | 800 | 45 | 65 | 0.908 | WHITE | 1 | 1 |
| 145-50465 | 5207227453366 | 36 | 6500 | 800 | 45 | 65 | 0.908 | BLACK | 1 | 1 |
| 145-50466 | 5207227453373 | 36 | 4000 | 800 | 45 | 65 | 0.908 | BLACK | 1 | 1 |
| 145-50467 | 5207227453380 | 36 | 3000 | 800 | 45 | 65 | 0.908 | BLACK | 1 | 1 |

| Code | Barcode | Watt | Kelvin | Dimension (mm) | | | Weight (kg) | Color | Packing | MOQ |
|-----------|---------------|------|--------|----------------|----|----|-------------|-------|---------|-----|
| | | | | ↕ | ↔ | ↕ | | | | |
| 145-50400 | 5207227303524 | 40 | 6500 | 1000 | 45 | 65 | 1.135 | WHITE | 1 | 1 |
| 145-50401 | 5207227303531 | 40 | 4000 | 1000 | 45 | 65 | 1.135 | WHITE | 1 | 1 |
| 145-50402 | 5207227303548 | 40 | 3000 | 1000 | 45 | 65 | 1.135 | WHITE | 1 | 1 |
| 145-50403 | 5207227303555 | 40 | 6500 | 1000 | 45 | 65 | 1.135 | BLACK | 1 | 1 |
| 145-50404 | 5207227303562 | 40 | 4000 | 1000 | 45 | 65 | 1.135 | BLACK | 1 | 1 |
| 145-50405 | 5207227303579 | 40 | 3000 | 1000 | 45 | 65 | 1.135 | BLACK | 1 | 1 |



| Code | Barcode | Watt | Kelvin | Dimension (mm) | | | Weight (kg) | Color | Packing | MOQ |
|-----------|---------------|------|--------|----------------|------|----|-------------|-------|---------|-----|
| | | | | ↕ | ↔ | ↕ | | | | |
| 145-50410 | 5207227303586 | 48 | 6500 | 1200 x | 45 x | 65 | 1.358 | WHITE | 1 | 1 |
| 145-50411 | 5207227303593 | 48 | 4000 | 1200 x | 45 x | 65 | 1.358 | WHITE | 1 | 1 |
| 145-50412 | 5207227303609 | 48 | 3000 | 1200 x | 45 x | 65 | 1.358 | WHITE | 1 | 1 |
| 145-50413 | 5207227303616 | 48 | 6500 | 1200 x | 45 x | 65 | 1.358 | BLACK | 1 | 1 |
| 145-50414 | 5207227303623 | 48 | 4000 | 1200 x | 45 x | 65 | 1.358 | BLACK | 1 | 1 |
| 145-50415 | 5207227303630 | 48 | 3000 | 1200 x | 45 x | 65 | 1.358 | BLACK | 1 | 1 |

| Code | Barcode | Watt | Kelvin | Dimension (mm) | | | Weight (kg) | Color | Packing | MOQ |
|-----------|---------------|------|--------|----------------|------|----|-------------|-------|---------|-----|
| | | | | ↕ | ↔ | ↕ | | | | |
| 145-50420 | 5207227303647 | 60 | 6500 | 1500 x | 45 x | 65 | 1.635 | WHITE | 1 | 1 |
| 145-50421 | 5207227303654 | 60 | 4000 | 1500 x | 45 x | 65 | 1.635 | WHITE | 1 | 1 |
| 145-50422 | 5207227303661 | 60 | 3000 | 1500 x | 45 x | 65 | 1.635 | WHITE | 1 | 1 |
| 145-50423 | 5207227303678 | 60 | 6500 | 1500 x | 45 x | 65 | 1.635 | BLACK | 1 | 1 |
| 145-50424 | 5207227303685 | 60 | 4000 | 1500 x | 45 x | 65 | 1.635 | BLACK | 1 | 1 |
| 145-50425 | 5207227303692 | 60 | 3000 | 1500 x | 45 x | 65 | 1.635 | BLACK | 1 | 1 |

| Code | Barcode | Watt | Kelvin | Dimension (mm) | | | Weight (kg) | Color | Packing | MOQ |
|-----------|---------------|------|--------|----------------|------|----|-------------|-------|---------|-----|
| | | | | ↕ | ↔ | ↕ | | | | |
| 145-50430 | 5207227303708 | 80 | 6500 | 2000 x | 45 x | 65 | 2.205 | WHITE | 1 | 1 |
| 145-50431 | 5207227303715 | 80 | 4000 | 2000 x | 45 x | 65 | 2.205 | WHITE | 1 | 1 |
| 145-50432 | 5207227303722 | 80 | 3000 | 2000 x | 45 x | 65 | 2.205 | WHITE | 1 | 1 |
| 145-50433 | 5207227303739 | 80 | 6500 | 2000 x | 45 x | 65 | 2.205 | BLACK | 1 | 1 |
| 145-50434 | 5207227303746 | 80 | 4000 | 2000 x | 45 x | 65 | 2.205 | BLACK | 1 | 1 |
| 145-50435 | 5207227303753 | 80 | 3000 | 2000 x | 45 x | 65 | 2.205 | BLACK | 1 | 1 |

| Code | Barcode | Watt | Kelvin | Dimension (mm) | | | Weight (kg) | Color | Packing | MOQ |
|-----------|---------------|------|--------|----------------|------|----|-------------|-------|---------|-----|
| | | | | ↕ | ↔ | ↕ | | | | |
| 145-50440 | 5207227303760 | 120 | 6500 | 3000 x | 45 x | 65 | 3.170 | WHITE | 1 | 1 |
| 145-50441 | 5207227303777 | 120 | 4000 | 3000 x | 45 x | 65 | 3.170 | WHITE | 1 | 1 |
| 145-50442 | 5207227303784 | 120 | 3000 | 3000 x | 45 x | 65 | 3.170 | WHITE | 1 | 1 |
| 145-50443 | 5207227303791 | 120 | 6500 | 3000 x | 45 x | 65 | 3.170 | BLACK | 1 | 1 |
| 145-50444 | 5207227303807 | 120 | 4000 | 3000 x | 45 x | 65 | 3.170 | BLACK | 1 | 1 |
| 145-50445 | 5207227303814 | 120 | 3000 | 3000 x | 45 x | 65 | 3.170 | BLACK | 1 | 1 |



Δυνατότητα διαχείρισης
Manageability

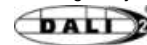

Ποικιλία
χρωμάτων
Variety
of colors



Δυνατότητα
ειδικών διαστάσεων
Available in
custom sizes



2-5m
Installation
Height



FLICKER
FREE



50.000h



ON
OFF



IP40



CLASS II



IK08



CE



PRO
SERIES

180 lm/W 65X45

Volt 220-240V 50/60Hz • LED Type SMD2835 • Chip Brand Lumileds

Start Time 0,5 sec • PF >95 • Operating Temperature -20°C / +40°C

Connection Καλώδιο / Wire

Material Αλουμίνιο & Πλαστικό / Aluminium & Plastic

| | | | | |
|-----------------------------|------------------|--------------------|-----------------|------------------------|
| LUMEN / WATT lm/W 180 | CRI Ra >80 | BEAM ANGLE 120° | NON DIMMABLE | 5 YEARS WARRANTY |
|-----------------------------|------------------|--------------------|-----------------|------------------------|

| Code | Barcode | Watt | Kelvin | Dimension (mm) | | | Weight (kg) | Color | Packing | MOQ |
|-----------|---------------|------|--------|----------------|------|----|-------------|-------|---------|-----|
| | | | | ↕ | ↔ | ↕ | | | | |
| 145-50468 | 5207227453397 | 15 | 6500 | 400 x | 45 x | 65 | 0.534 | WHITE | 1 | 1 |
| 145-50469 | 5207227453403 | 15 | 4000 | 400 x | 45 x | 65 | 0.534 | WHITE | 1 | 1 |
| 145-50470 | 5207227453410 | 15 | 3000 | 400 x | 45 x | 65 | 0.534 | WHITE | 1 | 1 |
| 145-50471 | 5207227453427 | 15 | 6500 | 400 x | 45 x | 65 | 0.534 | BLACK | 1 | 1 |
| 145-50472 | 5207227453434 | 15 | 4000 | 400 x | 45 x | 65 | 0.534 | BLACK | 1 | 1 |
| 145-50473 | 5207227453441 | 15 | 3000 | 400 x | 45 x | 65 | 0.534 | BLACK | 1 | 1 |

| Code | Barcode | Watt | Kelvin | Dimension (mm) | | | Weight (kg) | Color | Packing | MOQ |
|-----------|---------------|------|--------|----------------|------|----|-------------|-------|---------|-----|
| | | | | ↕ | ↔ | ↕ | | | | |
| 145-50474 | 5207227453458 | 21,5 | 6500 | 600 x | 45 x | 65 | 0.801 | WHITE | 1 | 1 |
| 145-50475 | 5207227453465 | 21,5 | 4000 | 600 x | 45 x | 65 | 0.801 | WHITE | 1 | 1 |
| 145-50476 | 5207227453472 | 21,5 | 3000 | 600 x | 45 x | 65 | 0.801 | WHITE | 1 | 1 |
| 145-50477 | 5207227453489 | 21,5 | 6500 | 600 x | 45 x | 65 | 0.801 | BLACK | 1 | 1 |
| 145-50478 | 5207227453496 | 21,5 | 4000 | 600 x | 45 x | 65 | 0.801 | BLACK | 1 | 1 |
| 145-50479 | 5207227453502 | 21,5 | 3000 | 600 x | 45 x | 65 | 0.801 | BLACK | 1 | 1 |

| Code | Barcode | Watt | Kelvin | Dimension (mm) | | | Weight (kg) | Color | Packing | MOQ |
|-----------|---------------|------|--------|----------------|------|----|-------------|-------|---------|-----|
| | | | | ↕ | ↔ | ↕ | | | | |
| 145-50480 | 5207227453519 | 29 | 6500 | 800 x | 45 x | 65 | 1.068 | WHITE | 1 | 1 |
| 145-50481 | 5207227453526 | 29 | 4000 | 800 x | 45 x | 65 | 1.068 | WHITE | 1 | 1 |
| 145-50482 | 5207227453533 | 29 | 3000 | 800 x | 45 x | 65 | 1.068 | WHITE | 1 | 1 |
| 145-50483 | 5207227453540 | 29 | 6500 | 800 x | 45 x | 65 | 1.068 | BLACK | 1 | 1 |
| 145-50484 | 5207227453557 | 29 | 4000 | 800 x | 45 x | 65 | 1.068 | BLACK | 1 | 1 |
| 145-50485 | 5207227453564 | 29 | 3000 | 800 x | 45 x | 65 | 1.068 | BLACK | 1 | 1 |

| Code | Barcode | Watt | Kelvin | Dimension (mm) | | | Weight (kg) | Color | Packing | MOQ |
|-----------|---------------|------|--------|----------------|------|----|-------------|-------|---------|-----|
| | | | | ↕ | ↔ | ↕ | | | | |
| 145-50500 | 5207227303821 | 35,7 | 6500 | 1000 x | 45 x | 65 | 1.335 | WHITE | 1 | 1 |
| 145-50501 | 5207227303838 | 35,7 | 4000 | 1000 x | 45 x | 65 | 1.335 | WHITE | 1 | 1 |
| 145-50502 | 5207227303845 | 35,7 | 3000 | 1000 x | 45 x | 65 | 1.335 | WHITE | 1 | 1 |
| 145-50503 | 5207227303852 | 35,7 | 6500 | 1000 x | 45 x | 65 | 1.335 | BLACK | 1 | 1 |
| 145-50504 | 5207227303869 | 35,7 | 4000 | 1000 x | 45 x | 65 | 1.335 | BLACK | 1 | 1 |
| 145-50505 | 5207227303876 | 35,7 | 3000 | 1000 x | 45 x | 65 | 1.335 | BLACK | 1 | 1 |



| Code | Barcode | Watt | Kelvin | Dimension (mm) | | | Weight (kg) | Color | Packing | MOQ |
|-----------|---------------|------|--------|----------------|------|----|-------------|-------|---------|-----|
| | | | | ↕ | ↔ | ↕ | | | | |
| 145-50510 | 5207227303883 | 43,2 | 6500 | 1200 x | 45 x | 65 | 1.558 | WHITE | 1 | 1 |
| 145-50511 | 5207227303890 | 43,2 | 4000 | 1200 x | 45 x | 65 | 1.558 | WHITE | 1 | 1 |
| 145-50512 | 5207227303906 | 43,2 | 3000 | 1200 x | 45 x | 65 | 1.558 | WHITE | 1 | 1 |
| 145-50513 | 5207227303913 | 43,2 | 6500 | 1200 x | 45 x | 65 | 1.558 | BLACK | 1 | 1 |
| 145-50514 | 5207227303920 | 43,2 | 4000 | 1200 x | 45 x | 65 | 1.558 | BLACK | 1 | 1 |
| 145-50515 | 5207227303937 | 43,2 | 3000 | 1200 x | 45 x | 65 | 1.558 | BLACK | 1 | 1 |

| Code | Barcode | Watt | Kelvin | Dimension (mm) | | | Weight (kg) | Color | Packing | MOQ |
|-----------|---------------|------|--------|----------------|------|----|-------------|-------|---------|-----|
| | | | | ↕ | ↔ | ↕ | | | | |
| 145-50520 | 5207227303944 | 57,2 | 6500 | 1500 x | 45 x | 65 | 1.835 | WHITE | 1 | 1 |
| 145-50521 | 5207227303951 | 57,2 | 4000 | 1500 x | 45 x | 65 | 1.835 | WHITE | 1 | 1 |
| 145-50522 | 5207227303968 | 57,2 | 3000 | 1500 x | 45 x | 65 | 1.835 | WHITE | 1 | 1 |
| 145-50523 | 5207227303975 | 57,2 | 6500 | 1500 x | 45 x | 65 | 1.835 | BLACK | 1 | 1 |
| 145-50524 | 5207227303982 | 57,2 | 4000 | 1500 x | 45 x | 65 | 1.835 | BLACK | 1 | 1 |
| 145-50525 | 5207227303999 | 57,2 | 3000 | 1500 x | 45 x | 65 | 1.835 | BLACK | 1 | 1 |

| Code | Barcode | Watt | Kelvin | Dimension (mm) | | | Weight (kg) | Color | Packing | MOQ |
|-----------|---------------|------|--------|----------------|------|----|-------------|-------|---------|-----|
| | | | | ↕ | ↔ | ↕ | | | | |
| 145-50530 | 5207227304002 | 71,4 | 6500 | 2000 x | 45 x | 65 | 2.205 | WHITE | 1 | 1 |
| 145-50531 | 5207227304019 | 71,4 | 4000 | 2000 x | 45 x | 65 | 2.205 | WHITE | 1 | 1 |
| 145-50532 | 5207227304026 | 71,4 | 3000 | 2000 x | 45 x | 65 | 2.205 | WHITE | 1 | 1 |
| 145-50533 | 5207227304033 | 71,4 | 6500 | 2000 x | 45 x | 65 | 2.205 | BLACK | 1 | 1 |
| 145-50534 | 5207227304040 | 71,4 | 4000 | 2000 x | 45 x | 65 | 2.205 | BLACK | 1 | 1 |
| 145-50535 | 5207227304057 | 71,4 | 3000 | 2000 x | 45 x | 65 | 2.205 | BLACK | 1 | 1 |

| Code | Barcode | Watt | Kelvin | Dimension (mm) | | | Weight (kg) | Color | Packing | MOQ |
|-----------|---------------|-------|--------|----------------|------|----|-------------|-------|---------|-----|
| | | | | ↕ | ↔ | ↕ | | | | |
| 145-50540 | 5207227304064 | 107,1 | 6500 | 3000 x | 45 x | 65 | 3.370 | WHITE | 1 | 1 |
| 145-50541 | 5207227304071 | 107,1 | 4000 | 3000 x | 45 x | 65 | 3.370 | WHITE | 1 | 1 |
| 145-50542 | 5207227304088 | 107,1 | 3000 | 3000 x | 45 x | 65 | 3.370 | WHITE | 1 | 1 |
| 145-50543 | 5207227304095 | 107,1 | 6500 | 3000 x | 45 x | 65 | 3.370 | BLACK | 1 | 1 |
| 145-50544 | 5207227304101 | 107,1 | 4000 | 3000 x | 45 x | 65 | 3.370 | BLACK | 1 | 1 |
| 145-50545 | 5207227304118 | 107,1 | 3000 | 3000 x | 45 x | 65 | 3.370 | BLACK | 1 | 1 |



180 lm/W Γωνία - Corner



Ποικιλία χρωμάτων
Variety of colors



Δυνατότητα ειδικών διαστάσεων
Available in custom sizes



Δυνατότητα διαχείρισης
Manageability
DALI 2

EOKE
LED Driver



FLICKER FREE



50.000h



ON OFF



IP40



CLASS II



IK08



CE



Green arrow icon



Volt 220-240V 50/60Hz • LED Type SMD2835 • Chip Brand Lumileds
Start Time 0,5 sec • PF >95 • Operating Temperature -20°C / +40°C
Connection Καλώδιο / Wire
Material Αλουμίνιο & Πλαστικό / Aluminium & Plastic

| | | | | |
|----------------------------|-------------------------|---------------------------|--------------|------------------|
| LUMEN / WATT 180 | CRI Ra >80 | BEAM ANGLE 120° | NON DIMMABLE | 5 YEARS WARRANTY |
|----------------------------|-------------------------|---------------------------|--------------|------------------|

| Code | Barcode | Watt | Kelvin | Dimension ∅ (mm) ↔ | Weight (kg) | Color | Packing | MOQ |
|-----------|---------------|------|--------|-----------------------|----------------|-------|---------|-----|
| 145-50486 | 5207227453571 | 71,4 | 6500 | 1000 x 1000 | 2.670 | WHITE | 1 | 1 |
| 145-50487 | 5207227453588 | 71,4 | 4000 | 1000 x 1000 | 2.670 | WHITE | 1 | 1 |
| 145-50488 | 5207227453595 | 71,4 | 3000 | 1000 x 1000 | 2.670 | WHITE | 1 | 1 |



180 lm/W Τετράγωνο - Square

| Code | Barcode | Watt | Kelvin | Dimension ∅ (mm) ↔ | Weight (kg) | Color | Packing | MOQ |
|-----------|---------------|-------|--------|-----------------------|----------------|-------|---------|-----|
| 145-50489 | 5207227453601 | 142,8 | 6500 | 1000 x 1000 | 5.340 | WHITE | 1 | 1 |
| 145-50490 | 5207227453618 | 142,8 | 4000 | 1000 x 1000 | 5.340 | WHITE | 1 | 1 |
| 145-50491 | 5207227453625 | 142,8 | 3000 | 1000 x 1000 | 5.340 | WHITE | 1 | 1 |
| 145-50492 | 5207227453632 | 172,8 | 6500 | 1000 x 1000 | 5.340 | WHITE | 1 | 1 |
| 145-50493 | 5207227453649 | 172,8 | 4000 | 1000 x 1000 | 5.340 | WHITE | 1 | 1 |
| 145-50494 | 5207227453656 | 172,8 | 3000 | 1000 x 1000 | 5.340 | WHITE | 1 | 1 |



180 lm/W Σχήμα "Π" - Shape "Π"

| Code | Barcode | Watt | Kelvin | Dimension ∅ (mm) ↔ | Weight (kg) | Color | Packing | MOQ |
|-----------|---------------|------|--------|-----------------------|----------------|-------|---------|-----|
| 145-50495 | 5207227453663 | 95 | 6500 | 1000 x 1000 | 4.005 | WHITE | 1 | 1 |
| 145-50496 | 5207227453670 | 95 | 4000 | 1000 x 1000 | 4.005 | WHITE | 1 | 1 |
| 145-50497 | 5207227453687 | 95 | 3000 | 1000 x 1000 | 4.005 | WHITE | 1 | 1 |



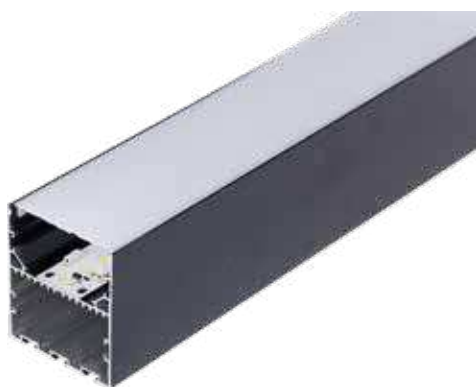

Ποικιλία χρωμάτων
Variety of colors



Δυνατότητα ειδικών διαστάσεων
Available in custom sizes



Δυνατότητα διαχείρισης
Manageability

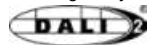

FLICKER FREE



50.000h



ON OFF



IP40



CLASS II



IK08



CE



E



130 lm/W 80X70

Volt 220-240V 50/60Hz • LED Type SMD2835 • Chip Brand Lumileds

Start Time 0,5 sec • PF >95 • Operating Temperature -20°C / +40°C

Connection Καλώδιο / Wire

Material Αλουμίνιο & Πλαστικό / Aluminium & Plastic

| | | | | |
|-----------------------------|------------------|--------------------|--------------|------------------|
| LUMEN / WATT lm/W 130 | CRI Ra >80 | BEAM ANGLE 120° | NON DIMMABLE | 5 YEARS WARRANTY |
|-----------------------------|------------------|--------------------|--------------|------------------|

| Code | Barcode | Watt | Kelvin | Dimension (mm) | | | Weight (kg) | Color | Packing | MOQ |
|-----------|---------------|------|--------|----------------|----|----|-------------|-------|---------|-----|
| | | | | ↕ | ↔ | ↕ | | | | |
| 145-50750 | 5207227453694 | 18 | 6500 | 400 | 70 | 80 | 0.728 | WHITE | 1 | 1 |
| 145-50751 | 5207227453700 | 18 | 4000 | 400 | 70 | 80 | 0.728 | WHITE | 1 | 1 |
| 145-50752 | 5207227453717 | 18 | 3000 | 400 | 70 | 80 | 0.728 | WHITE | 1 | 1 |
| 145-50753 | 5207227453724 | 18 | 6500 | 400 | 70 | 80 | 0.728 | BLACK | 1 | 1 |
| 145-50754 | 5207227453731 | 18 | 4000 | 400 | 70 | 80 | 0.728 | BLACK | 1 | 1 |
| 145-50755 | 5207227453748 | 18 | 3000 | 400 | 70 | 80 | 0.728 | BLACK | 1 | 1 |
| | | | | | | | | | | |
| Code | Barcode | Watt | Kelvin | Dimension (mm) | | | Weight (kg) | Color | Packing | MOQ |
| | | | | ↕ | ↔ | ↕ | | | | |
| 145-50756 | 5207227453755 | 27 | 6500 | 600 | 70 | 80 | 1.092 | WHITE | 1 | 1 |
| 145-50757 | 5207227453762 | 27 | 4000 | 600 | 70 | 80 | 1.092 | WHITE | 1 | 1 |
| 145-50758 | 5207227453779 | 27 | 3000 | 600 | 70 | 80 | 1.092 | WHITE | 1 | 1 |
| 145-50759 | 5207227453786 | 27 | 6500 | 600 | 70 | 80 | 1.092 | BLACK | 1 | 1 |
| 145-50760 | 5207227453793 | 27 | 4000 | 600 | 70 | 80 | 1.092 | BLACK | 1 | 1 |
| 145-50761 | 5207227453809 | 27 | 3000 | 600 | 70 | 80 | 1.092 | BLACK | 1 | 1 |
| | | | | | | | | | | |
| Code | Barcode | Watt | Kelvin | Dimension (mm) | | | Weight (kg) | Color | Packing | MOQ |
| | | | | ↕ | ↔ | ↕ | | | | |
| 145-50762 | 5207227453816 | 36 | 6500 | 800 | 70 | 80 | 1.456 | WHITE | 1 | 1 |
| 145-50763 | 5207227453823 | 36 | 4000 | 800 | 70 | 80 | 1.456 | WHITE | 1 | 1 |
| 145-50764 | 5207227453830 | 36 | 3000 | 800 | 70 | 80 | 1.456 | WHITE | 1 | 1 |
| 145-50765 | 5207227453847 | 36 | 6500 | 800 | 70 | 80 | 1.456 | BLACK | 1 | 1 |
| 145-50766 | 5207227453854 | 36 | 4000 | 800 | 70 | 80 | 1.456 | BLACK | 1 | 1 |
| 145-50767 | 5207227453861 | 36 | 3000 | 800 | 70 | 80 | 1.456 | BLACK | 1 | 1 |
| | | | | | | | | | | |
| Code | Barcode | Watt | Kelvin | Dimension (mm) | | | Weight (kg) | Color | Packing | MOQ |
| | | | | ↕ | ↔ | ↕ | | | | |
| 145-50700 | 5207227304125 | 40 | 6500 | 1000 | 70 | 80 | 1.820 | WHITE | 1 | 1 |
| 145-50701 | 5207227304132 | 40 | 4000 | 1000 | 70 | 80 | 1.820 | WHITE | 1 | 1 |
| 145-50702 | 5207227304149 | 40 | 3000 | 1000 | 70 | 80 | 1.820 | WHITE | 1 | 1 |
| 145-50703 | 5207227304156 | 40 | 6500 | 1000 | 70 | 80 | 1.820 | BLACK | 1 | 1 |
| 145-50704 | 5207227304163 | 40 | 4000 | 1000 | 70 | 80 | 1.820 | BLACK | 1 | 1 |
| 145-50705 | 5207227304170 | 40 | 3000 | 1000 | 70 | 80 | 1.820 | BLACK | 1 | 1 |



| Code | Barcode | Watt | Kelvin | Dimension (mm) | | | Weight (kg) | Color | Packing | MOQ |
|-----------|---------------|------|--------|----------------|----|----|-------------|-------|---------|-----|
| | | | | ↕ | ↔ | ↕ | | | | |
| 145-50710 | 5207227304187 | 48 | 6500 | 1200 | 70 | 80 | 2.455 | WHITE | 1 | 1 |
| 145-50711 | 5207227304194 | 48 | 4000 | 1200 | 70 | 80 | 2.455 | WHITE | 1 | 1 |
| 145-50712 | 5207227304200 | 48 | 3000 | 1200 | 70 | 80 | 2.455 | WHITE | 1 | 1 |
| 145-50713 | 5207227304217 | 48 | 6500 | 1200 | 70 | 80 | 2.455 | BLACK | 1 | 1 |
| 145-50714 | 5207227304224 | 48 | 4000 | 1200 | 70 | 80 | 2.455 | BLACK | 1 | 1 |
| 145-50715 | 5207227304231 | 48 | 3000 | 1200 | 70 | 80 | 2.455 | BLACK | 1 | 1 |

| Code | Barcode | Watt | Kelvin | Dimension (mm) | | | Weight (kg) | Color | Packing | MOQ |
|-----------|---------------|------|--------|----------------|----|----|-------------|-------|---------|-----|
| | | | | ↕ | ↔ | ↕ | | | | |
| 145-50720 | 5207227304248 | 60 | 6500 | 1500 | 70 | 80 | 2.745 | WHITE | 1 | 1 |
| 145-50721 | 5207227304255 | 60 | 4000 | 1500 | 70 | 80 | 2.745 | WHITE | 1 | 1 |
| 145-50722 | 5207227304262 | 60 | 3000 | 1500 | 70 | 80 | 2.745 | WHITE | 1 | 1 |
| 145-50723 | 5207227304279 | 60 | 6500 | 1500 | 70 | 80 | 2.745 | BLACK | 1 | 1 |
| 145-50724 | 5207227304286 | 60 | 4000 | 1500 | 70 | 80 | 2.745 | BLACK | 1 | 1 |
| 145-50725 | 5207227304293 | 60 | 3000 | 1500 | 70 | 80 | 2.745 | BLACK | 1 | 1 |

| Code | Barcode | Watt | Kelvin | Dimension (mm) | | | Weight (kg) | Color | Packing | MOQ |
|-----------|---------------|------|--------|----------------|----|----|-------------|-------|---------|-----|
| | | | | ↕ | ↔ | ↕ | | | | |
| 145-50730 | 5207227304309 | 80 | 6500 | 2000 | 70 | 80 | 3.595 | WHITE | 1 | 1 |
| 145-50731 | 5207227304316 | 80 | 4000 | 2000 | 70 | 80 | 3.595 | WHITE | 1 | 1 |
| 145-50732 | 5207227304323 | 80 | 3000 | 2000 | 70 | 80 | 3.595 | WHITE | 1 | 1 |
| 145-50733 | 5207227304330 | 80 | 6500 | 2000 | 70 | 80 | 3.595 | BLACK | 1 | 1 |
| 145-50734 | 5207227304347 | 80 | 4000 | 2000 | 70 | 80 | 3.595 | BLACK | 1 | 1 |
| 145-50735 | 5207227304354 | 80 | 3000 | 2000 | 70 | 80 | 3.595 | BLACK | 1 | 1 |

| Code | Barcode | Watt | Kelvin | Dimension (mm) | | | Weight (kg) | Color | Packing | MOQ |
|-----------|---------------|------|--------|----------------|----|----|-------------|-------|---------|-----|
| | | | | ↕ | ↔ | ↕ | | | | |
| 145-50740 | 5207227304361 | 120 | 6500 | 3000 | 70 | 80 | 5.455 | WHITE | 1 | 1 |
| 145-50741 | 5207227304378 | 120 | 4000 | 3000 | 70 | 80 | 5.455 | WHITE | 1 | 1 |
| 145-50742 | 5207227304385 | 120 | 3000 | 3000 | 70 | 80 | 5.455 | WHITE | 1 | 1 |
| 145-50743 | 5207227304392 | 120 | 6500 | 3000 | 70 | 80 | 5.455 | BLACK | 1 | 1 |
| 145-50744 | 5207227304408 | 120 | 4000 | 3000 | 70 | 80 | 5.455 | BLACK | 1 | 1 |
| 145-50745 | 5207227304415 | 120 | 3000 | 3000 | 70 | 80 | 5.455 | BLACK | 1 | 1 |



Δυνατότητα διαχείρισης
Manageability

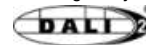

Ποικιλία
χρωμάτων
Variety
of colors



Δυνατότητα
ειδικών διαστάσεων
Available in
custom sizes

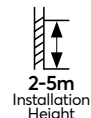

2-5m
Installation
Height



FLICKER
FREE



50.000h



ON
OFF



IP40



CLASS II



IK08



CE



PRO
SERIES

180 lm/W 80X70

Volt 220-240V 50/60Hz • LED Type SMD2835 • Chip Brand Lumileds

Start Time 0,5 sec • PF >95 • Operating Temperature -20°C / +40°C

Connection Καλώδιο / Wire

Material Αλουμίνιο & Πλαστικό / Aluminium & Plastic

| | | | | |
|-----------------------------|------------------|--------------------|-----------------|------------------------|
| LUMEN / WATT lm/W 180 | CRI Ra >80 | BEAM ANGLE 120° | NON DIMMABLE | 5 YEARS WARRANTY |
|-----------------------------|------------------|--------------------|-----------------|------------------------|

| Code | Barcode | Watt | Kelvin | Dimension (mm) | | | Weight (kg) | Color | Packing | MOQ |
|-----------|---------------|------|--------|----------------|------|----|-------------|-------|---------|-----|
| | | | | ↕ | ↔ | ↕ | | | | |
| 145-50768 | 5207227453878 | 15 | 6500 | 400 x | 70 x | 80 | 0.808 | WHITE | 1 | 1 |
| 145-50769 | 5207227453885 | 15 | 4000 | 400 x | 70 x | 80 | 0.808 | WHITE | 1 | 1 |
| 145-50770 | 5207227453892 | 15 | 3000 | 400 x | 70 x | 80 | 0.808 | WHITE | 1 | 1 |
| 145-50771 | 5207227453908 | 15 | 6500 | 400 x | 70 x | 80 | 0.808 | BLACK | 1 | 1 |
| 145-50772 | 5207227453915 | 15 | 4000 | 400 x | 70 x | 80 | 0.808 | BLACK | 1 | 1 |
| 145-50773 | 5207227453922 | 15 | 3000 | 400 x | 70 x | 80 | 0.808 | BLACK | 1 | 1 |

| Code | Barcode | Watt | Kelvin | Dimension (mm) | | | Weight (kg) | Color | Packing | MOQ |
|-----------|---------------|------|--------|----------------|------|----|-------------|-------|---------|-----|
| | | | | ↕ | ↔ | ↕ | | | | |
| 145-50774 | 5207227453939 | 21,5 | 6500 | 600 x | 70 x | 80 | 1.212 | WHITE | 1 | 1 |
| 145-50775 | 5207227453946 | 21,5 | 4000 | 600 x | 70 x | 80 | 1.212 | WHITE | 1 | 1 |
| 145-50776 | 5207227453953 | 21,5 | 3000 | 600 x | 70 x | 80 | 1.212 | WHITE | 1 | 1 |
| 145-50777 | 5207227453960 | 21,5 | 6500 | 600 x | 70 x | 80 | 1.212 | BLACK | 1 | 1 |
| 145-50778 | 5207227453977 | 21,5 | 4000 | 600 x | 70 x | 80 | 1.212 | BLACK | 1 | 1 |
| 145-50779 | 5207227453984 | 21,5 | 3000 | 600 x | 70 x | 80 | 1.212 | BLACK | 1 | 1 |

| Code | Barcode | Watt | Kelvin | Dimension (mm) | | | Weight (kg) | Color | Packing | MOQ |
|-----------|---------------|------|--------|----------------|------|----|-------------|-------|---------|-----|
| | | | | ↕ | ↔ | ↕ | | | | |
| 145-50780 | 5207227453991 | 29 | 6500 | 800 x | 70 x | 80 | 1.616 | WHITE | 1 | 1 |
| 145-50781 | 5207227454004 | 29 | 4000 | 800 x | 70 x | 80 | 1.616 | WHITE | 1 | 1 |
| 145-50782 | 5207227454011 | 29 | 3000 | 800 x | 70 x | 80 | 1.616 | WHITE | 1 | 1 |
| 145-50783 | 5207227454028 | 29 | 6500 | 800 x | 70 x | 80 | 1.616 | BLACK | 1 | 1 |
| 145-50784 | 5207227454035 | 29 | 4000 | 800 x | 70 x | 80 | 1.616 | BLACK | 1 | 1 |
| 145-50785 | 5207227454042 | 29 | 3000 | 800 x | 70 x | 80 | 1.616 | BLACK | 1 | 1 |

| Code | Barcode | Watt | Kelvin | Dimension (mm) | | | Weight (kg) | Color | Packing | MOQ |
|-----------|---------------|------|--------|----------------|------|----|-------------|-------|---------|-----|
| | | | | ↕ | ↔ | ↕ | | | | |
| 145-50800 | 5207227304422 | 35,7 | 6500 | 1000 x | 70 x | 80 | 2.020 | WHITE | 1 | 1 |
| 145-50801 | 5207227304439 | 35,7 | 4000 | 1000 x | 70 x | 80 | 2.020 | WHITE | 1 | 1 |
| 145-50802 | 5207227304446 | 35,7 | 3000 | 1000 x | 70 x | 80 | 2.020 | WHITE | 1 | 1 |
| 145-50803 | 5207227304453 | 35,7 | 6500 | 1000 x | 70 x | 80 | 2.020 | BLACK | 1 | 1 |
| 145-50804 | 5207227304460 | 35,7 | 4000 | 1000 x | 70 x | 80 | 2.020 | BLACK | 1 | 1 |
| 145-50805 | 5207227304477 | 35,7 | 3000 | 1000 x | 70 x | 80 | 2.020 | BLACK | 1 | 1 |



| Code | Barcode | Watt | Kelvin | Dimension (mm) | | | Weight (kg) | Color | Packing | MOQ |
|-----------|---------------|------|--------|----------------|------|----|-------------|-------|---------|-----|
| | | | | ↕ | ↔ | ↕ | | | | |
| 145-50810 | 5207227304484 | 43,2 | 6500 | 1200 x | 70 x | 80 | 2.655 | WHITE | 1 | 1 |
| 145-50811 | 5207227304491 | 43,2 | 4000 | 1200 x | 70 x | 80 | 2.655 | WHITE | 1 | 1 |
| 145-50812 | 5207227304507 | 43,2 | 3000 | 1200 x | 70 x | 80 | 2.655 | WHITE | 1 | 1 |
| 145-50813 | 5207227304514 | 43,2 | 6500 | 1200 x | 70 x | 80 | 2.655 | BLACK | 1 | 1 |
| 145-50814 | 5207227304521 | 43,2 | 4000 | 1200 x | 70 x | 80 | 2.655 | BLACK | 1 | 1 |
| 145-50815 | 5207227304538 | 43,2 | 3000 | 1200 x | 70 x | 80 | 2.655 | BLACK | 1 | 1 |

| Code | Barcode | Watt | Kelvin | Dimension (mm) | | | Weight (kg) | Color | Packing | MOQ |
|-----------|---------------|------|--------|----------------|------|----|-------------|-------|---------|-----|
| | | | | ↕ | ↔ | ↕ | | | | |
| 145-50820 | 5207227304545 | 57,2 | 6500 | 1500 x | 70 x | 80 | 2.945 | WHITE | 1 | 1 |
| 145-50821 | 5207227304552 | 57,2 | 4000 | 1500 x | 70 x | 80 | 2.945 | WHITE | 1 | 1 |
| 145-50822 | 5207227304569 | 57,2 | 3000 | 1500 x | 70 x | 80 | 2.945 | WHITE | 1 | 1 |
| 145-50823 | 5207227304576 | 57,2 | 6500 | 1500 x | 70 x | 80 | 2.945 | BLACK | 1 | 1 |
| 145-50824 | 5207227304583 | 57,2 | 4000 | 1500 x | 70 x | 80 | 2.945 | BLACK | 1 | 1 |
| 145-50825 | 5207227304590 | 57,2 | 3000 | 1500 x | 70 x | 80 | 2.945 | BLACK | 1 | 1 |

| Code | Barcode | Watt | Kelvin | Dimension (mm) | | | Weight (kg) | Color | Packing | MOQ |
|-----------|---------------|------|--------|----------------|------|----|-------------|-------|---------|-----|
| | | | | ↕ | ↔ | ↕ | | | | |
| 145-50830 | 5207227304606 | 71,4 | 6500 | 2000 x | 70 x | 80 | 3.795 | WHITE | 1 | 1 |
| 145-50831 | 5207227304613 | 71,4 | 4000 | 2000 x | 70 x | 80 | 3.795 | WHITE | 1 | 1 |
| 145-50832 | 5207227304620 | 71,4 | 3000 | 2000 x | 70 x | 80 | 3.795 | WHITE | 1 | 1 |
| 145-50833 | 5207227304637 | 71,4 | 6500 | 2000 x | 70 x | 80 | 3.795 | BLACK | 1 | 1 |
| 145-50834 | 5207227304644 | 71,4 | 4000 | 2000 x | 70 x | 80 | 3.795 | BLACK | 1 | 1 |
| 145-50835 | 5207227304651 | 71,4 | 3000 | 2000 x | 70 x | 80 | 3.795 | BLACK | 1 | 1 |

| Code | Barcode | Watt | Kelvin | Dimension (mm) | | | Weight (kg) | Color | Packing | MOQ |
|-----------|---------------|-------|--------|----------------|------|----|-------------|-------|---------|-----|
| | | | | ↕ | ↔ | ↕ | | | | |
| 145-50840 | 5207227304668 | 107,1 | 6500 | 3000 x | 70 x | 80 | 5.655 | WHITE | 1 | 1 |
| 145-50841 | 5207227304675 | 107,1 | 4000 | 3000 x | 70 x | 80 | 5.655 | WHITE | 1 | 1 |
| 145-50842 | 5207227304682 | 107,1 | 3000 | 3000 x | 70 x | 80 | 5.655 | WHITE | 1 | 1 |
| 145-50843 | 5207227304699 | 107,1 | 6500 | 3000 x | 70 x | 80 | 5.655 | BLACK | 1 | 1 |
| 145-50844 | 5207227304705 | 107,1 | 4000 | 3000 x | 70 x | 80 | 5.655 | BLACK | 1 | 1 |
| 145-50845 | 5207227304712 | 107,1 | 3000 | 3000 x | 70 x | 80 | 5.655 | BLACK | 1 | 1 |



180 lm/W Γωνία - Corner



Ποικιλία χρωμάτων
Variety of colors



Δυνατότητα ειδικών διαστάσεων
Available in custom sizes



Δυνατότητα διαχείρισης
Manageability
DALI 2

EOKE
LED Driver



FLICKER FREE



50.000h



ON OFF



IP40



CLASS II



IK08



CE



Green arrow icon



Volt 220-240V 50/60Hz • LED Type SMD2835 • Chip Brand Lumileds
Start Time 0,5 sec • PF >95 • Operating Temperature -20°C / +40°C
Connection Καλώδιο / Wire
Material Αλουμίνιο & Πλαστικό / Aluminium & Plastic

| | | | | |
|-----------------------------|------------------|--------------------|--------------|------------------|
| LUMEN / WATT lm/W 180 | CRI Ra >80 | BEAM ANGLE 120° | NON DIMMABLE | 5 YEARS WARRANTY |
|-----------------------------|------------------|--------------------|--------------|------------------|

| Code | Barcode | Watt | Kelvin | Dimension ∅ (mm) ↔ | Weight (kg) | Color | Packing | MOQ |
|-----------|---------------|------|--------|-----------------------|----------------|-------|---------|-----|
| 145-50786 | 5207227454059 | 71,4 | 6500 | 1000 x 1000 | 4.040 | WHITE | 1 | 1 |
| 145-50787 | 5207227454066 | 71,4 | 4000 | 1000 x 1000 | 4.040 | WHITE | 1 | 1 |
| 145-50788 | 5207227454073 | 71,4 | 3000 | 1000 x 1000 | 4.040 | WHITE | 1 | 1 |



180 lm/W Τετράγωνο - Square

| Code | Barcode | Watt | Kelvin | Dimension ∅ (mm) ↔ | Weight (kg) | Color | Packing | MOQ |
|-----------|---------------|-------|--------|-----------------------|----------------|-------|---------|-----|
| 145-50789 | 5207227454080 | 142,8 | 6500 | 1000 x 1000 | 8.080 | WHITE | 1 | 1 |
| 145-50790 | 5207227454097 | 142,8 | 4000 | 1000 x 1000 | 8.080 | WHITE | 1 | 1 |
| 145-50791 | 5207227454103 | 142,8 | 3000 | 1000 x 1000 | 8.080 | WHITE | 1 | 1 |
| 145-50792 | 5207227454110 | 172,8 | 6500 | 1000 x 1000 | 8.080 | WHITE | 1 | 1 |
| 145-50793 | 5207227454127 | 172,8 | 4000 | 1000 x 1000 | 8.080 | WHITE | 1 | 1 |
| 145-50794 | 5207227454134 | 172,8 | 3000 | 1000 x 1000 | 8.080 | WHITE | 1 | 1 |



180 lm/W Σχήμα "Π" - Shape "Π"

| Code | Barcode | Watt | Kelvin | Dimension ∅ (mm) ↔ | Weight (kg) | Color | Packing | MOQ |
|-----------|---------------|------|--------|-----------------------|----------------|-------|---------|-----|
| 145-50795 | 5207227454141 | 95 | 6500 | 1000 x 1000 | 6.060 | WHITE | 1 | 1 |
| 145-50796 | 5207227454158 | 95 | 4000 | 1000 x 1000 | 6.060 | WHITE | 1 | 1 |
| 145-50797 | 5207227454165 | 95 | 3000 | 1000 x 1000 | 6.060 | WHITE | 1 | 1 |

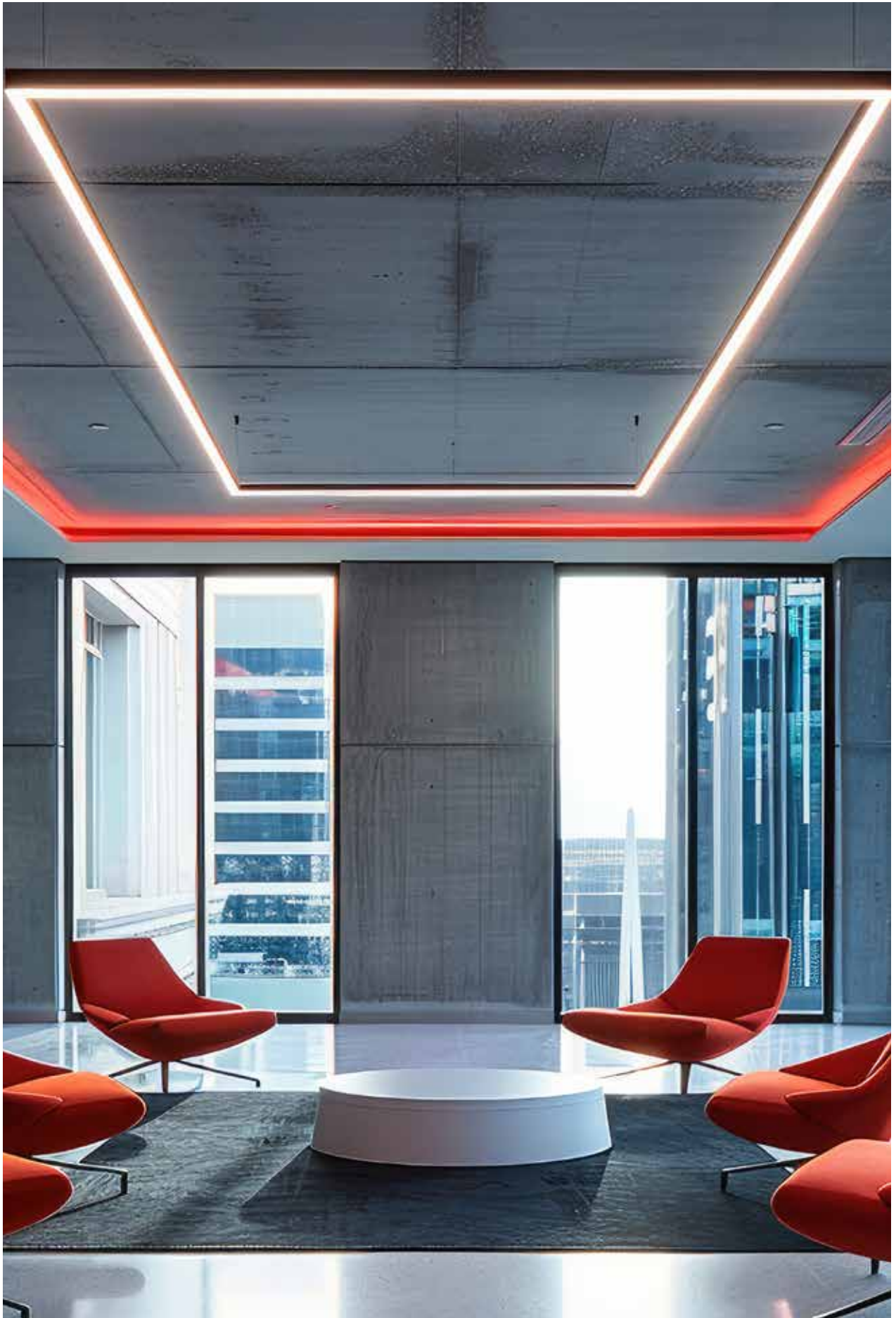



Ποικιλία
χρωμάτων
Variety
of colors



Δυνατότητα
ειδικών διαστάσεων
Available in
custom sizes

2-5m
Installation
Height

Δυνατότητα διαχείρισης
Manageability
DALI 2

LIFUD
LED Driver

130-150 lm/W

Φως Κάτω Στρογγυλό - Circular Downlight

**FLICKER
FREE**

50.000h

**ON
OFF**
30.000

IP40

CLASS II

IK08

CE

D

**PRO
SERIES**

Volt 220-240V 50/60Hz • LED Type SMD2835 • Chip Brand Lumileds
Start Time 0,5 sec • PF >95 • Operating Temperature -20°C / +40°C
Connection Καλώδιο / Wire
Material Αλουμίνιο & Πλαστικό / Aluminium & Plastic

| | | | | |
|---|-----------------------------------|----------------------------------|-------------------------|---------------------------------|
| LUMEN / WATT lm/W 130-150 | CRI Ra >80 | BEAM ANGLE 120° | NON DIMMABLE | 5 YEARS WARRANTY |
|---|-----------------------------------|----------------------------------|-------------------------|---------------------------------|

| Code | Barcode | Watt | Kelvin | Dimension Ø (mm) † | Weight (kg) | Color | Packing | MOQ |
|------------------|---------------|------|--------|-----------------------|----------------|-------|---------|-----|
| 145-53000 | 5207227454172 | 84 | 6500 | 800 x 35 | 2.785 | BLACK | 1 | 1 |
| 145-53001 | 5207227454189 | 84 | 4000 | 800 x 35 | 2.785 | BLACK | 1 | 1 |
| 145-53002 | 5207227454196 | 84 | 3000 | 800 x 35 | 2.785 | BLACK | 1 | 1 |

| Code | Barcode | Watt | Kelvin | Dimension Ø (mm) † | Weight (kg) | Color | Packing | MOQ |
|------------------|---------------|------|--------|-----------------------|----------------|-------|---------|-----|
| 145-53010 | 5207227454202 | 104 | 6500 | 1000 x 35 | 3.785 | BLACK | 1 | 1 |
| 145-53011 | 5207227454219 | 104 | 4000 | 1000 x 35 | 3.785 | BLACK | 1 | 1 |
| 145-53012 | 5207227454226 | 104 | 3000 | 1000 x 35 | 3.785 | BLACK | 1 | 1 |

| Code | Barcode | Watt | Kelvin | Dimension Ø (mm) † | Weight (kg) | Color | Packing | MOQ |
|------------------|---------------|------|--------|-----------------------|----------------|-------|---------|-----|
| 145-53020 | 5207227454233 | 126 | 6500 | 1200 x 35 | 4.315 | BLACK | 1 | 1 |
| 145-53021 | 5207227454240 | 126 | 4000 | 1200 x 35 | 4.315 | BLACK | 1 | 1 |
| 145-53022 | 5207227454257 | 126 | 3000 | 1200 x 35 | 4.315 | BLACK | 1 | 1 |

| Code | Barcode | Watt | Kelvin | Dimension Ø (mm) † | Weight (kg) | Color | Packing | MOQ |
|------------------|---------------|------|--------|-----------------------|----------------|-------|---------|-----|
| 145-53030 | 5207227454264 | 156 | 6500 | 1500 x 35 | 5.515 | BLACK | 1 | 1 |
| 145-53031 | 5207227454271 | 156 | 4000 | 1500 x 35 | 5.515 | BLACK | 1 | 1 |
| 145-53032 | 5207227454288 | 156 | 3000 | 1500 x 35 | 5.515 | BLACK | 1 | 1 |



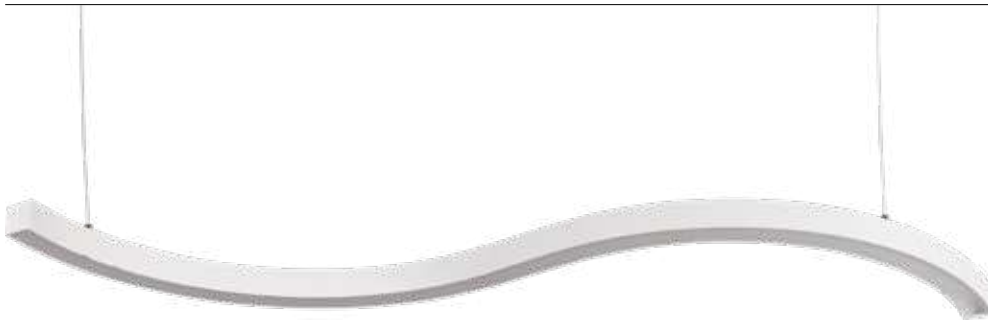

Δυνατότητα διαχείρισης
Manageability



Ποικιλία
χρωμάτων
Variety
of colors



Δυνατότητα
ειδικών διαστάσεων
Available in
custom sizes

2-5m
Installation
Height



130-150 lm/W Τύπου "S" - Type "S"



FLICKER
FREE



50.000h



ON
OFF



IP40



CLASS II



IK08



CE



D



Volt 220-240V 50/60Hz • LED Type SMD2835 • Chip Brand Lumileds
Start Time 0,5 sec • PF >95 • Operating Temperature -20°C / +40°C
Connection Καλώδιο / Wire
Material Αλουμίνιο & Πλαστικό / Aluminium & Plastic

| | | | | |
|--|-------------------------|---------------------------|-----------------|------------------------|
| LUMEN / WATT lm/W 130-150 | CRI Ra >80 | BEAM ANGLE 120° | NON DIMMABLE | 5 YEARS WARRANTY |
|--|-------------------------|---------------------------|-----------------|------------------------|

| Code | Barcode | Watt | Kelvin | Dimension ∅ (mm) † | Weight (kg) | Color | Packing | MOQ |
|-----------|---------------|------|--------|-----------------------|----------------|-------|---------|-----|
| 145-53200 | 5207227454530 | 40 | 6500 | 1200 x 35 | 1.790 | BLACK | 1 | 1 |
| 145-53201 | 5207227454547 | 40 | 4000 | 1200 x 35 | 1.790 | BLACK | 1 | 1 |
| 145-53202 | 5207227454554 | 40 | 3000 | 1200 x 35 | 1.790 | BLACK | 1 | 1 |

| Code | Barcode | Watt | Kelvin | Dimension ∅ (mm) † | Weight (kg) | Color | Packing | MOQ |
|-----------|---------------|------|--------|-----------------------|----------------|-------|---------|-----|
| 145-53210 | 5207227454561 | 50 | 6500 | 1500 x 35 | 2.210 | BLACK | 1 | 1 |
| 145-53211 | 5207227454578 | 50 | 4000 | 1500 x 35 | 2.210 | BLACK | 1 | 1 |
| 145-53212 | 5207227454585 | 50 | 3000 | 1500 x 35 | 2.210 | BLACK | 1 | 1 |

| Code | Barcode | Watt | Kelvin | Dimension ∅ (mm) † | Weight (kg) | Color | Packing | MOQ |
|-----------|---------------|------|--------|-----------------------|----------------|-------|---------|-----|
| 145-53220 | 5207227454592 | 66 | 6500 | 2000 x 35 | 2.785 | BLACK | 1 | 1 |
| 145-53221 | 5207227454608 | 66 | 4000 | 2000 x 35 | 2.785 | BLACK | 1 | 1 |
| 145-53222 | 5207227454615 | 66 | 3000 | 2000 x 35 | 2.785 | BLACK | 1 | 1 |





Ποικιλία
χρωμάτων
Variety
of colors



Δυνατότητα
ειδικών διαστάσεων
Available in
custom sizes

2-5m
Installation
Height

Δυνατότητα διαχείρισης
Manageability
DALI 2

LIFUD
LED Driver

160 lm/W Στρογγυλό - Circular Εσωτερικό Φως - Interior Light

FLICKER
FREE

50.000h

ON
OFF
30.000

IP40

CLASS II

IK08

CE

C

PRO
SERIES

Volt 220-240V 50/60Hz • LED Type SMD2835 • Chip Brand Lumileds
Start Time 0,5 sec • PF >95 • Operating Temperature -20°C / +40°C
Connection Καλώδιο / Wire
Material Αλουμίνιο & Πλαστικό / Aluminium & Plastic

LUMEN / WATT
lm/W
160

CRI
Ra
>80

BEAM ANGLE
120°

NON
DIMMABLE

5
YEARS
WARRANTY

| Code | Barcode | Watt | Kelvin | Dimension Ø (mm) † | Weight (kg) | Color | Packing | MOQ |
|-----------|---------------|------|--------|-----------------------|----------------|-------|---------|-----|
| 145-53100 | 5207227454295 | 23 | 6500 | 600 x 31 | 1.280 | BLACK | 1 | 1 |
| 145-53101 | 5207227454301 | 23 | 4000 | 600 x 31 | 1.280 | BLACK | 1 | 1 |
| 145-53102 | 5207227454318 | 23 | 3000 | 600 x 31 | 1.280 | BLACK | 1 | 1 |

| Code | Barcode | Watt | Kelvin | Dimension Ø (mm) † | Weight (kg) | Color | Packing | MOQ |
|-----------|---------------|------|--------|-----------------------|----------------|-------|---------|-----|
| 145-53110 | 5207227454325 | 30 | 6500 | 800 x 31 | 1.695 | BLACK | 1 | 1 |
| 145-53111 | 5207227454332 | 30 | 4000 | 800 x 31 | 1.695 | BLACK | 1 | 1 |
| 145-53112 | 5207227454349 | 30 | 3000 | 800 x 31 | 1.695 | BLACK | 1 | 1 |

| Code | Barcode | Watt | Kelvin | Dimension Ø (mm) † | Weight (kg) | Color | Packing | MOQ |
|-----------|---------------|------|--------|-----------------------|----------------|-------|---------|-----|
| 145-53120 | 5207227454356 | 38 | 6500 | 1000 x 31 | 2.230 | BLACK | 1 | 1 |
| 145-53121 | 5207227454363 | 38 | 4000 | 1000 x 31 | 2.230 | BLACK | 1 | 1 |
| 145-53122 | 5207227454370 | 38 | 3000 | 1000 x 31 | 2.230 | BLACK | 1 | 1 |

| Code | Barcode | Watt | Kelvin | Dimension Ø (mm) † | Weight (kg) | Color | Packing | MOQ |
|-----------|---------------|------|--------|-----------------------|----------------|-------|---------|-----|
| 145-53130 | 5207227454387 | 45 | 6500 | 1200 x 31 | 2.580 | BLACK | 1 | 1 |
| 145-53131 | 5207227454394 | 45 | 4000 | 1200 x 31 | 2.580 | BLACK | 1 | 1 |
| 145-53132 | 5207227454400 | 45 | 3000 | 1200 x 31 | 2.580 | BLACK | 1 | 1 |



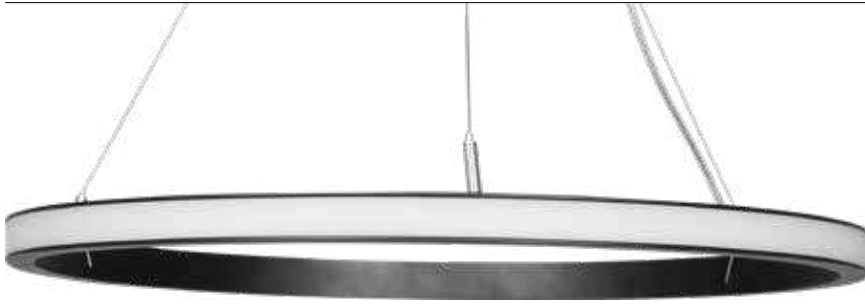

Ποικιλία χρωμάτων
Variety of colors



Δυνατότητα ειδικών διαστάσεων
Available in custom sizes

2-5m
Installation
Height

Δυνατότητα διαχείρισης
Manageability
DALI 2

LIFUD
LED Driver

160 lm/W Στρογγυλό - Circular Εξωτερικό Φως - Outdoor Light

FLICKER
FREE

50.000h

ON
OFF
30.000

IP40

CLASS II

IK08

CE

C

PRO
SERIES

Volt 220-240V 50/60Hz • LED Type SMD2835 • Chip Brand Lumileds
Start Time 0,5 sec • PF >95 • Operating Temperature -20°C / +40°C
Connection Καλώδιο / Wire
Material Αλουμίνιο & Πλαστικό / Aluminium & Plastic

LUMEN / WATT
lm/W
160

CRI
Ra
>80

BEAM ANGLE
120°

NON
DIMMABLE

5
YEARS
WARRANTY

| Code | Barcode | Watt | Kelvin | Dimension Ø (mm) † | Weight (kg) | Color | Packing | MOQ |
|-----------|---------------|------|--------|-----------------------|----------------|-------|---------|-----|
| 145-53140 | 5207227454417 | 23 | 6500 | 600 x 31 | 1.210 | BLACK | 1 | 1 |
| 145-53141 | 5207227454424 | 23 | 4000 | 600 x 31 | 1.210 | BLACK | 1 | 1 |
| 145-53142 | 5207227454431 | 23 | 3000 | 600 x 31 | 1.210 | BLACK | 1 | 1 |

| Code | Barcode | Watt | Kelvin | Dimension Ø (mm) † | Weight (kg) | Color | Packing | MOQ |
|-----------|---------------|------|--------|-----------------------|----------------|-------|---------|-----|
| 145-53150 | 5207227454448 | 30 | 6500 | 800 x 31 | 1.685 | BLACK | 1 | 1 |
| 145-53151 | 5207227454455 | 30 | 4000 | 800 x 31 | 1.685 | BLACK | 1 | 1 |
| 145-53152 | 5207227454462 | 30 | 3000 | 800 x 31 | 1.685 | BLACK | 1 | 1 |

| Code | Barcode | Watt | Kelvin | Dimension Ø (mm) † | Weight (kg) | Color | Packing | MOQ |
|-----------|---------------|------|--------|-----------------------|----------------|-------|---------|-----|
| 145-53160 | 5207227454479 | 38 | 6500 | 1000 x 31 | 2.220 | BLACK | 1 | 1 |
| 145-53161 | 5207227454486 | 38 | 4000 | 1000 x 31 | 2.220 | BLACK | 1 | 1 |
| 145-53162 | 5207227454493 | 38 | 3000 | 1000 x 31 | 2.220 | BLACK | 1 | 1 |

| Code | Barcode | Watt | Kelvin | Dimension Ø (mm) † | Weight (kg) | Color | Packing | MOQ |
|-----------|---------------|------|--------|-----------------------|----------------|-------|---------|-----|
| 145-53170 | 5207227454509 | 45 | 6500 | 1200 x 31 | 2.575 | BLACK | 1 | 1 |
| 145-53171 | 5207227454516 | 45 | 4000 | 1200 x 31 | 2.575 | BLACK | 1 | 1 |
| 145-53172 | 5207227454523 | 45 | 3000 | 1200 x 31 | 2.575 | BLACK | 1 | 1 |





Προφίλ Αλουμινίου για Γραμμικά Φωτιστικά - Εξωτερικό (Συναρμολόγηση)
Profile (Fitting)

CE

| Code | Dimension (mm) | | | Color | Packing | MOQ |
|-----------|----------------|----|----|-------|---------|-----|
| | ↗ | ↔ | ↕ | | | |
| 145-79700 | 1000 | 45 | 65 | WHITE | 1 | 1 |
| 145-79701 | 1200 | 45 | 65 | WHITE | 1 | 1 |
| 145-79702 | 1500 | 45 | 65 | WHITE | 1 | 1 |
| 145-79703 | 2000 | 45 | 65 | WHITE | 1 | 1 |
| 145-79704 | 3000 | 45 | 65 | WHITE | 1 | 1 |
| 145-79705 | 1000 | 70 | 80 | WHITE | 1 | 1 |
| 145-79706 | 1200 | 70 | 80 | WHITE | 1 | 1 |
| 145-79707 | 1500 | 70 | 80 | WHITE | 1 | 1 |
| 145-79708 | 2000 | 70 | 80 | WHITE | 1 | 1 |
| 145-79709 | 3000 | 70 | 80 | WHITE | 1 | 1 |
| 145-79710 | 1000 | 45 | 65 | BLACK | 1 | 1 |
| 145-79711 | 1200 | 45 | 65 | BLACK | 1 | 1 |
| 145-79712 | 1500 | 45 | 65 | BLACK | 1 | 1 |
| 145-79713 | 2000 | 45 | 65 | BLACK | 1 | 1 |
| 145-79714 | 3000 | 45 | 65 | BLACK | 1 | 1 |
| 145-79715 | 1000 | 70 | 80 | BLACK | 1 | 1 |
| 145-79716 | 1200 | 70 | 80 | BLACK | 1 | 1 |
| 145-79717 | 1500 | 70 | 80 | BLACK | 1 | 1 |
| 145-79718 | 2000 | 70 | 80 | BLACK | 1 | 1 |
| 145-79719 | 3000 | 70 | 80 | BLACK | 1 | 1 |

Προφίλ Αλουμινίου για Γραμμικά Φωτιστικά - Χωνευτά Οροφής C081-W
Profile (Fitting) - Recessed Roof

CE

| Code | Dimension (mm) | | | Color | Packing | MOQ |
|-----------|----------------|----|----|-------|---------|-----|
| | ↗ | ↔ | ↕ | | | |
| 145-79720 | 1000 | 50 | 30 | WHITE | 1 | 1 |
| 145-79721 | 1200 | 50 | 30 | WHITE | 1 | 1 |
| 145-79722 | 1500 | 50 | 30 | WHITE | 1 | 1 |
| 145-79723 | 2000 | 50 | 30 | WHITE | 1 | 1 |

Προφίλ Αλουμινίου για Γραμμικά Φωτιστικά S - Εξωτερικό (Συναρμολόγηση)
Profile S Exterior (Fitting)

CE

| Code | Dimension (mm) | | | Color | Packing | MOQ |
|-----------|----------------|----|----|-------|---------|-----|
| | ↗ | ↔ | ↕ | | | |
| 145-79040 | 1200 | 35 | 35 | WHITE | 1 | 1 |
| 145-79041 | 1500 | 35 | 35 | WHITE | 1 | 1 |
| 145-79042 | 2000 | 35 | 35 | WHITE | 1 | 1 |

Προφίλ Αλουμινίου για Γραμμικά Φωτιστικά - Στρογγυλά Εσωτερικό Φως
Profile (Fitting) - Round Interior Light

CE

| Code | Dimension (mm) | | Color | Packing | MOQ |
|-----------|----------------|----|-------|---------|-----|
| | ∅ | ℎ | | | |
| 145-79050 | 600 | 31 | BLACK | 1 | 1 |
| 145-79051 | 800 | 31 | BLACK | 1 | 1 |
| 145-79052 | 1000 | 31 | BLACK | 1 | 1 |
| 145-79053 | 1200 | 31 | BLACK | 1 | 1 |

Προφίλ Αλουμινίου για Γραμμικά Φωτιστικά - Στρογγυλά Εξωτερικό Φως
Profile (Fitting) - Round Exterior Light

CE

| Code | Dimension (mm) | | Color | Packing | MOQ |
|-----------|----------------|----|-------|---------|-----|
| | ∅ | ℎ | | | |
| 145-79060 | 600 | 31 | BLACK | 1 | 1 |
| 145-79061 | 800 | 31 | BLACK | 1 | 1 |
| 145-79062 | 1000 | 31 | BLACK | 1 | 1 |
| 145-79063 | 1200 | 31 | BLACK | 1 | 1 |

Προφίλ Αλουμινίου για Γραμμικά Φωτιστικά - Στρογγυλά Εξωτερικό Κάτω Φως
Profile (Fitting) - Round Exterior Light

CE

| Code | Dimension (mm) | | Color | Packing | MOQ |
|-----------|----------------|----|-------|---------|-----|
| | ∅ | ℎ | | | |
| 145-79070 | 600 | 35 | BLACK | 1 | 1 |
| 145-79071 | 800 | 35 | BLACK | 1 | 1 |
| 145-79072 | 1000 | 35 | BLACK | 1 | 1 |
| 145-79073 | 1200 | 35 | BLACK | 1 | 1 |

Ντίζα Για Προφίλ Αλουμινίου 2 Τεμ. Hanging Set 2 pcs

| | |
|-----------|--|
| Code | |
| 145-79800 | |



Βάση Οροφής Μεταλλική Metal Ceiling Base

| | |
|-----------|--|
| Code | |
| 145-79801 | |



Γωνία Εξωτερική Exterior Corner 90° Metal Joiner

| | |
|-----------|--|
| Code | |
| 145-79802 | |



Γωνία Εσωτερική Interior Corner 90° Metal Joiner

| | |
|-----------|--|
| Code | |
| 145-79803 | |



Σύνδεσμος Ευθείας Direct Link 180° Metal Joiner

| | |
|-----------|--|
| Code | |
| 145-79804 | |



Τάπα Πλαστική για Εξωτερικά Φωτιστικά Plastic End Cap For Surface Mounted Light Fixtures

65x45mm

| Code | Color |
|-----------|-------|
| 145-79805 | WHITE |
| 145-79807 | BLACK |

80x70mm

| Code | Color |
|-----------|-------|
| 145-79806 | WHITE |
| 145-79808 | BLACK |



Ντίζα Για Προφίλ Αλουμινίου 2m Hanging Set 2m

| | |
|-----------|--|
| Code | |
| 145-79823 | |



Ντίζα Για Προφίλ Αλουμινίου με Αλλαγή Κλήσης 2m - Hanging Set 2m

| | |
|-----------|--|
| Code | |
| 145-79824 | |



Βάση Οροφής Αποστάτη Ceiling Distant Base

| | |
|-----------|--|
| Code | |
| 145-79813 | |



Ροζέτα Οροφής Στήριξης Ceiling Base

| | |
|-----------|--|
| Code | |
| 145-79820 | |



Ροζέτα Οροφής με Είσοδο Παροχής Ceiling Base

| | |
|-----------|--|
| Code | |
| 145-79821 | |



Ταφ Εσωτερικό T-Connect Interior Metal Joiner

| | |
|-----------|--|
| Code | |
| 145-79814 | |



Σταυρός Εσωτερικό Cross Connect Interior Metal Joiner

| | |
|-----------|--|
| Code | |
| 145-79815 | |



Clips Γυψοσανίδας για το Χωνευτό Προφίλ Αλουμινίου CO81-W Plasterboard Clips for Aluminum Profile CO81-W

| | |
|-----------|--|
| Code | |
| 145-79809 | |



Γωνία 2 Επαφών Μεταλλική 90° για CO81-W Corner 2 Connections Metallic 90° for CO81-W

| | |
|-----------|--|
| Code | |
| 145-79810 | |



Ενωτικός Σύνδεσμος Μεταλλικός για CO81-W Aluminum Link 180° for CO81-W

| | |
|-----------|--|
| Code | |
| 145-79811 | |



Τάπα για τον Κωδικό CO81-W Cap for Code CO81-W















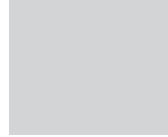







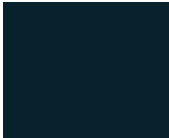



| | |
|-----------|--|
| Code | |
| 145-79812 | |



Κωδικοί Βαφής - Paint Codes

| Code | Colors |
|-----------|------------------------------------|
| 145-79880 | Βασικά Χρώματα - Basic Colors |
| 145-79881 | Ιδιαίτερα Χρώματα - Special Colors |

Βασικά Χρώματα - Basic Colors

| | | | | | |
|---|---|---|--|--|--|
|  |  |  |  |  |  |
| RAL9003 MATT / GLOSS | RAL9016 MATT | RAL9010 MATT | RAL9005 MATT / GLOSS | C0026 MATT | RAL9006 MATT |
|  |  |  |  |  |  |
| RAL7037 GLOSS | RAL7030 MATT | RAL7005 GLOSS | RAL7039 MATT | RAL7009 MATT | RAL7043 MATT |
|  |  |  |  |  |  |
| RAL7016 MATT | RAL7021 MATT | RAL7008 GLOSS | RAL1021 GLOSS | RAL1017 GLOSS | RAL2011 GLOSS |
|  |  |  |  |  |  |
| RAL2002 GLOSS | RAL3000 GLOSS | RAL5007 GLOSS | RAL5019 GLOSS | RAL6021 GLOSS | RAL6016 GLOSS |
|  |  |  | | | |
| RAL6027 GLOSS | RAL6027 GLOSS | RAL6018 GLOSS | | | |
| code | | | | | |
| 145-79880 | | | | | |

Ιδιαίτερα Χρώματα - Special Colors

| | | | | | |
|---|---|---|---|---|---|
|  |  |  |  |  |  |
| C0033 MATT | C0019 MATT | C0168 MATT | C5119 MATT | C3619 MATT | C3554 MATT |
|  |  |  | | | |
| RAL1035 MATT | C4686 GLOSS | C5792 MATT | | | |
| code | | | | | |
| 145-79881 | | | | | |

Η απεικόνιση των χρωμάτων είναι ενδεικτική και ενδέχεται να διαφέρει από την πραγματικότητα.
 Συμβουλευτείτε επίσημο χρωματολόγιο RAL. Ρωτήστε μας για οποιοδήποτε άλλο χρώμα της επιλογής σας.
 The display of colors is indicative and may deviates from reality.
 Consult the official RAL color palette. Ask us for any other color of your choice.





Σποτ LED Ράγας
& Μαγνητικής Ράγας

Track Spot LED Lights
& Magnetic Track

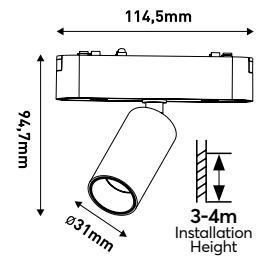

3CCT

(2700K 4300K 6000K)

Ultra Slim with Triac 5W



HAISRI
LED Driver

Volt DC 40V • LED Type COB • Chip Brand Epistar
Start Time 0.5 sec • PF >0.50 • Operating Temperature -20°C / +45°C
Connection Χάλκινο Σημείο Σύνδεσης / Copper Spot Connector
Material Αλουμίνιο - Πλαστικό - Χαλκός / Aluminium - Plastic - Copper

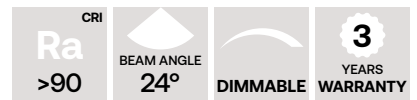

| Code | Barcode | Watt | Amperage mA | Kelvin | Lumen/Watt | Weight (kg) | Color | Packing | MOQ |
|-----------|---------------|------|-------------|--------|------------|-------------|--------|---------|-----|
| 145-59500 | 5207227286759 | 5 | 130 | 3CCT | 80 | 0.099 | BLACK | 1/30 | 1 |
| 145-59501 | 5207227286766 | 5 | 130 | 3CCT | 80 | 0.099 | WHITE | 1/30 | 1 |
| 145-59502 | 5207227286773 | 5 | 130 | 3CCT | 80 | 0.099 | BRONZE | 1/30 | 1 |

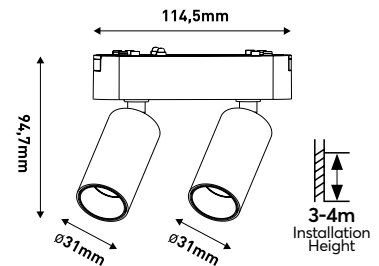

3CCT

(2700K 4300K 6000K)

Ultra Slim with Triac 2x5W



HAISRI
LED Driver

Volt DC 40V • LED Type COB • Chip Brand Epistar
Start Time 0.5 sec • PF >0.50 • Operating Temperature -20°C / +45°C
Connection Χάλκινο Σημείο Σύνδεσης / Copper Spot Connector
Material Αλουμίνιο - Πλαστικό - Χαλκός / Aluminium - Plastic - Copper

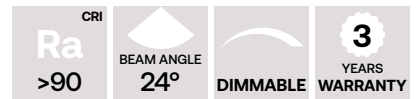

| Code | Barcode | Watt | Amperage mA | Kelvin | Lumen/Watt | Weight (kg) | Color | Packing | MOQ |
|-----------|---------------|------|-------------|--------|------------|-------------|-------|---------|-----|
| 145-59503 | 5207227286780 | 10 | 250 | 3CCT | 80 | 0.145 | BLACK | 1/30 | 1 |

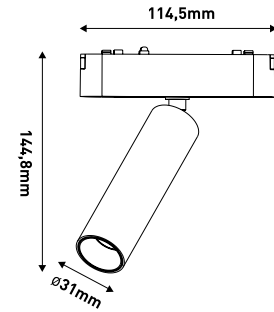

3CCT

(2700K 4300K 6000K)

Ultra Slim with Triac 7W



HAISRI
LED Driver

Volt DC 40V · LED Type COB · Chip Brand Epistar
Start Time 0.5 sec · PF >0.50 · Operating Temperature -20°C / +45°C
Connection Χάλκινο Σημείο Σύνδεσης / Copper Spot Connector
Material Αλουμίνιο - Πλαστικό - Χαλκός / Aluminium - Plastic - Copper

CRI **Ra >90** | BEAM ANGLE **24°** | DIMMABLE | **3** YEARS WARRANTY

| Code | Barcode | Watt | Amperage mA | Kelvin | Lumen/Watt | Weight (kg) | Color | Packing | MOQ |
|-----------|---------------|------|-------------|--------|------------|-------------|--------|---------|-----|
| 145-59504 | 5207227286797 | 7 | 170 | 3CCT | 80 | 0.161 | BLACK | 1/30 | 1 |
| 145-59505 | 5207227286803 | 7 | 170 | 3CCT | 80 | 0.161 | WHITE | 1/30 | 1 |
| 145-59506 | 5207227286810 | 7 | 170 | 3CCT | 80 | 0.161 | BRONZE | 1/30 | 1 |

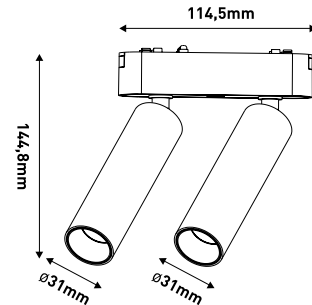

3CCT

(2700K 4300K 6000K)

Ultra Slim with Triac 2x7W



HAISRI
LED Driver

Volt DC 40V · LED Type COB · Chip Brand Epistar
Start Time 0.5 sec · PF >0.50 · Operating Temperature -20°C / +45°C
Connection Χάλκινο Σημείο Σύνδεσης / Copper Spot Connector
Material Αλουμίνιο - Πλαστικό - Χαλκός / Aluminium - Plastic - Copper

CRI **Ra >90** | BEAM ANGLE **24°** | DIMMABLE | **3** YEARS WARRANTY

| Code | Barcode | Watt | Amperage mA | Kelvin | Lumen/Watt | Weight (kg) | Color | Packing | MOQ |
|-----------|---------------|------|-------------|--------|------------|-------------|-------|---------|-----|
| 145-59507 | 5207227286827 | 14 | 350 | 3CCT | 80 | 0.277 | BLACK | 1/30 | 1 |

3CCT
(2700K 4300K 6000K)

3-4m Installation Height

FLICKER FREE 30.000h ON OFF 15.000 IP20 CLASS II CE G PRO SERIES

Ultra Slim with Triac 15W

Volt DC 40V • LED Type COB • Chip Brand Epistar
 Start Time 0.5 sec • PF >0.50 • Operating Temperature -20°C / +45°C
 Connection Χάλκινο Σημείο Σύνδεσης / Copper Spot Connector
 Material Αλουμίνιο - Πλαστικό - Χαλκός / Aluminium - Plastic - Copper

CRI **Ra >90** BEAM ANGLE **36°** DIMMABLE 3 YEARS WARRANTY

| Code | Barcode | Watt | Amperage mA | Kelvin | Lumen/Watt | Weight (kg) | Color | Packing | MOQ |
|-----------|---------------|------|-------------|--------|------------|-------------|--------|---------|-----|
| 145-59508 | 5207227286834 | 15 | 400 | 3CCT | 80 | 0.257 | BLACK | 1/30 | 1 |
| 145-59509 | 5207227286841 | 15 | 400 | 3CCT | 80 | 0.257 | WHITE | 1/30 | 1 |
| 145-59510 | 5207227286858 | 15 | 400 | 3CCT | 80 | 0.257 | BRONZE | 1/30 | 1 |

3CCT
(2700K 4300K 6000K)

3-4m Installation Height

FLICKER FREE 30.000h ON OFF 15.000 IP20 CLASS II CE G PRO SERIES

Ultra Slim with Triac 10W Ø100

Volt DC 40V • LED Type COB • Chip Brand Epistar
 Start Time 0.5 sec • PF >0.50 • Operating Temperature -20°C / +45°C
 Connection Χάλκινο Σημείο Σύνδεσης / Copper Spot Connector
 Material Αλουμίνιο - Πλαστικό - Χαλκός / Aluminium - Plastic - Copper

CRI **Ra >90** BEAM ANGLE **128°** DIMMABLE 3 YEARS WARRANTY

| Code | Barcode | Watt | Amperage mA | Kelvin | Lumen/Watt | Weight (kg) | Color | Packing | MOQ |
|-----------|---------------|------|-------------|--------|------------|-------------|-------|---------|-----|
| 145-59511 | 5207227286865 | 10 | 250 | 3CCT | 80 | 0.531 | BLACK | 1/20 | 1 |

3CCT
(2700K 4300K 6000K)

3-4m Installation Height

FLICKER FREE 30.000h ON OFF 15.000 IP20 CLASS II CE G PRO SERIES

Ultra Slim 15W Ø105mm

Volt DC 40V • LED Type COB • Chip Brand Epistar
 Start Time 0.5 sec • PF >0.50 • Operating Temperature -20°C / +45°C
 Connection Χάλκινο Σημείο Σύνδεσης / Copper Spot Connector
 Material Αλουμίνιο - Πλαστικό - Χαλκός / Aluminium - Plastic - Copper

CRI **Ra >90** BEAM ANGLE **36°** DIMMABLE 3 YEARS WARRANTY

| Code | Barcode | Watt | Amperage mA | Kelvin | Lumen/Watt | Weight (kg) | Color | Packing | MOQ |
|-----------|---------------|------|-------------|--------|------------|-------------|-------|---------|-----|
| 145-59518 | 5207227286933 | 15 | 400 | 3CCT | 80 | 0.456 | BLACK | 1/30 | 1 |
| 145-59519 | 5207227286940 | 15 | 400 | 3CCT | 80 | 0.456 | WHITE | 1/30 | 1 |

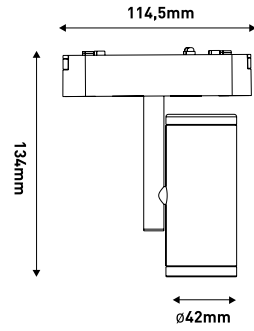

3-4m
Installation
Height

3CCT

(2700K 4300K 6000K)

Ultra Slim with Triac 8W



HAISRI
LED Driver

Volt DC 40V • LED Type COB • Chip Brand Epistar
Start Time 0.5 sec • PF >0.50 • Operating Temperature -20°C / +45°C
Connection Χάλκινο Σημείο Σύνδεσης / Copper Spot Connector
Material Αλουμίνιο - Πλαστικό - Χαλκός / Aluminium - Plastic - Copper

CRI **Ra >90** BEAM ANGLE **36°** DIMMABLE **3 YEARS WARRANTY**

| Code | Barcode | Watt | Amperage mA | Kelvin | Lumen/Watt | Weight (kg) | Color | Packing | MOQ |
|-----------|---------------|------|-------------|--------|------------|-------------|-------|---------|-----|
| 145-59512 | 5207227286872 | 8 | 200 | 3CCT | 80 | 0.181 | BLACK | 1/30 | 1 |

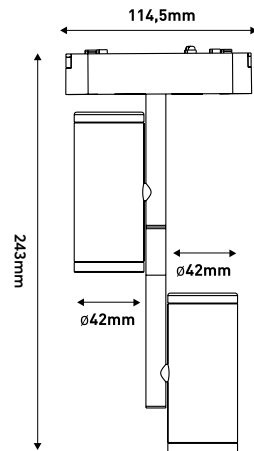

3-4m
Installation
Height

3CCT

(2700K 4300K 6000K)

Ultra Slim with Triac 2x8W



HAISRI
LED Driver

Volt DC 40V • LED Type COB • Chip Brand Epistar
Start Time 0.5 sec • PF >0.50 • Operating Temperature -20°C / +45°C
Connection Χάλκινο Σημείο Σύνδεσης / Copper Spot Connector
Material Αλουμίνιο - Πλαστικό - Χαλκός / Aluminium - Plastic - Copper

CRI **Ra >90** BEAM ANGLE **36°** DIMMABLE **3 YEARS WARRANTY**

| Code | Barcode | Watt | Amperage mA | Kelvin | Lumen/Watt | Weight (kg) | Color | Packing | MOQ |
|-----------|---------------|------|-------------|--------|------------|-------------|-------|---------|-----|
| 145-59513 | 5207227286889 | 16 | 400 | 3CCT | 80 | 0.340 | BLACK | 1/30 | 1 |

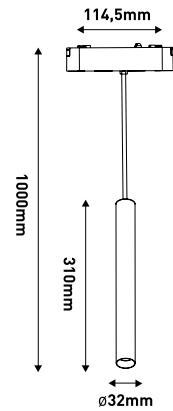

3CCT

(2700K 4300K 6000K)

Ultra Slim with Triac 7W



HAISRI
LED Driver

Volt DC 40V • LED Type COB • Chip Brand Epistar
Start Time 0.5 sec • PF >0.50 • Operating Temperature -20°C / +45°C
Connection Χάλκινο Σημείο Σύνδεσης / Copper Spot Connector
Material Αλουμίνιο - Πλαστικό - Χαλκός / Aluminium - Plastic - Copper

CRI **Ra >90** BEAM ANGLE **24°** DIMMABLE **3 YEARS WARRANTY**

| Code | Barcode | Watt | Amperage mA | Kelvin | Lumen/Watt | Weight (kg) | Color | Packing | MOQ |
|-----------|---------------|------|-------------|--------|------------|-------------|-------|---------|-----|
| 145-59514 | 5207227286896 | 7 | 170 | 3CCT | 80 | 0.321 | BLACK | 1/30 | 1 |
| 145-59515 | 5207227286902 | 7 | 170 | 3CCT | 80 | 0.321 | WHITE | 1/30 | 1 |

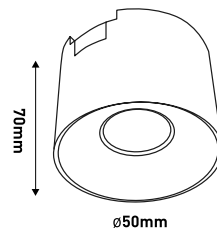

3CCT

(2700K 4300K 6000K)

Ultra Slim 8W 50x70mm



HAISRI
LED Driver

Volt DC 40V • LED Type COB • Chip Brand Epistar
Start Time 0.5 sec • PF >0.50 • Operating Temperature -20°C / +45°C
Connection Χάλκινο Σημείο Σύνδεσης / Copper Spot Connector
Material Αλουμίνιο - Πλαστικό - Χαλκός / Aluminium - Plastic - Copper

CRI **Ra >90** BEAM ANGLE **36°** DIMMABLE **3 YEARS WARRANTY**

| Code | Barcode | Watt | Amperage mA | Kelvin | Lumen/Watt | Weight (kg) | Color | Packing | MOQ |
|-----------|---------------|------|-------------|--------|------------|-------------|-------|---------|-----|
| 145-59516 | 5207227286919 | 8 | 200 | 3CCT | 80 | 0.165 | BLACK | 1/30 | 1 |
| 145-59517 | 5207227286926 | 8 | 200 | 3CCT | 80 | 0.165 | WHITE | 1/30 | 1 |

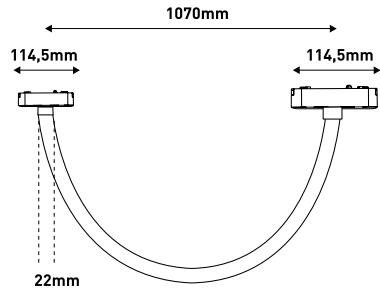

3CCT

(2700K 4300K 6000K)

Ultra Slim 18W 114.5x22x1070mm



HAISRI
LED Driver

Volt DC 40V · LED Type SMD2835 · Chip Brand Epistar
Start Time 0.5 sec · PF >0.50 · Operating Temperature -20°C / +45°C
Connection Χάλκινο Σημείο Σύνδεσης / Copper Spot Connector
Material Αλουμίνιο - Πλαστικό - Χαλκός / Aluminium - Plastic - Copper

CRI **Ra >90** BEAM ANGLE **360°** DIMMABLE 3 YEARS WARRANTY

| Code | Barcode | Watt | Amperage mA | Kelvin | Lumen/Watt | Weight (kg) | Color | Packing | MOQ |
|-----------|---------------|------|-------------|--------|------------|-------------|-------|---------|-----|
| 145-59520 | 5207227286957 | 18 | 450 | 3CCT | 70 | 0.915 | WHITE | 1/10 | 1 |

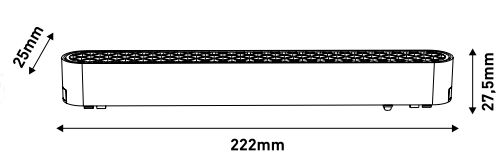

3CCT

(2700K 4300K 6000K)

Ultra Slim 12W 60°



HAISRI
LED Driver

Volt DC 40V · LED Type SMD2835 · Chip Brand Epistar
Start Time 0.5 sec · PF >0.50 · Operating Temperature -20°C / +45°C
Connection Χάλκινο Σημείο Σύνδεσης / Copper Spot Connector
Material Αλουμίνιο - Πλαστικό - Χαλκός / Aluminium - Plastic - Copper

CRI **Ra >90** BEAM ANGLE **60°** DIMMABLE 3 YEARS WARRANTY

| Code | Barcode | Watt | Amperage mA | Kelvin | Lumen/Watt | Weight (kg) | Color | Packing | MOQ |
|-----------|---------------|------|-------------|--------|------------|-------------|-------|---------|-----|
| 145-59528 | 5207227287022 | 12 | 300 | 3CCT | 45 | 0.136 | BLACK | 1/50 | 1 |
| 145-59533 | 5207227287077 | 12 | 300 | 3CCT | 45 | 0.136 | WHITE | 1/50 | 1 |



147-99836

Show Box for Ultra Slim

Περιλαμβάνει / Includes:

- 145-59545
- 145-59559
- 145-59560
- 145-59522
- 145-59523
- 145-59525
- 145-59526
- 145-59527
- 145-59528
- 145-59500
- 145-59504
- 145-59508
- 145-59550
- 145-59551
- 145-59554
- 145-59555
- 145-59557
- 145-59558

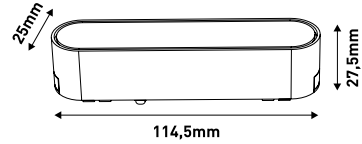

3CCT

(2700K 4300K 6000K)

Ultra Slim 6W 100°



HAISRI
LED Driver

Volt DC 40V • LED Type SMD2835 • Chip Brand Epistar
Start Time 0.5 sec • PF >0.50 • Operating Temperature -20°C / +45°C
Connection Χάλκινο Σημείο Σύνδεσης / Copper Spot Connector
Material Αλουμίνιο - Πλαστικό - Χαλκός / Aluminium - Plastic - Copper

CRI **Ra >90** BEAM ANGLE **100°** DIMMABLE 3 YEARS WARRANTY

| Code | Barcode | Watt | Amperage mA | Kelvin | Lumen/Watt | Weight (kg) | Color | Packing | MOQ |
|-----------|---------------|------|-------------|--------|------------|-------------|-------|---------|-----|
| 145-59522 | 5207227286964 | 6 | 150 | 3CCT | 50 | 0.072 | BLACK | 1/50 | 1 |
| 145-59529 | 5207227287039 | 6 | 150 | 3CCT | 50 | 0.072 | WHITE | 1/50 | 1 |

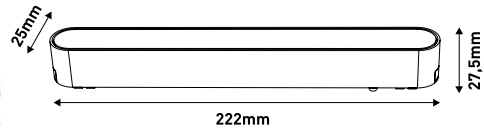

3CCT

(2700K 4300K 6000K)

Ultra Slim 12W 100°



HAISRI
LED Driver

Volt DC 40V • LED Type SMD2835 • Chip Brand Epistar
Start Time 0.5 sec • PF >0.50 • Operating Temperature -20°C / +45°C
Connection Χάλκινο Σημείο Σύνδεσης / Copper Spot Connector
Material Αλουμίνιο - Πλαστικό - Χαλκός / Aluminium - Plastic - Copper

CRI **Ra >90** BEAM ANGLE **100°** DIMMABLE 3 YEARS WARRANTY

| Code | Barcode | Watt | Amperage mA | Kelvin | Lumen/Watt | Weight (kg) | Color | Packing | MOQ |
|-----------|---------------|------|-------------|--------|------------|-------------|-------|---------|-----|
| 145-59523 | 5207227286971 | 12 | 300 | 3CCT | 50 | 0.135 | BLACK | 1/50 | 1 |
| 145-59530 | 5207227287046 | 12 | 300 | 3CCT | 50 | 0.135 | WHITE | 1/50 | 1 |

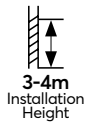
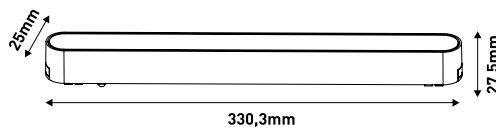

3CCT

(2700K 4300K 6000K)

Ultra Slim 16W 100°



HAISRI
LED Driver

Volt DC 40V • LED Type SMD2835 • Chip Brand Epistar
Start Time 0.5 sec • PF >0.50 • Operating Temperature -20°C / +45°C
Connection Χάλκινο Σημείο Σύνδεσης / Copper Spot Connector
Material Αλουμίνιο - Πλαστικό - Χαλκός / Aluminium - Plastic - Copper

CRI **Ra >90** BEAM ANGLE **100°** DIMMABLE 3 YEARS WARRANTY

| Code | Barcode | Watt | Amperage mA | Kelvin | Lumen/Watt | Weight (kg) | Color | Packing | MOQ |
|-----------|---------------|------|-------------|--------|------------|-------------|-------|---------|-----|
| 145-59524 | 5207227286988 | 16 | 400 | 3CCT | 50 | 0.204 | BLACK | 1/50 | 1 |

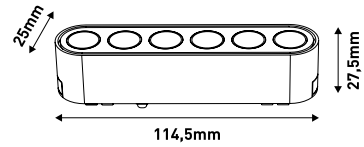

3CCT

(2700K 4300K 6000K)

Ultra Slim 6W 100°



HAISRI
LED Driver

Volt DC 40V · LED Type SMD3030 · Chip Brand Epistar
Start Time 0.5 sec · PF >0.50 · Operating Temperature -20°C / +45°C
Connection Χάλκινο Σημείο Σύνδεσης / Copper Spot Connector
Material Αλουμίνιο - Πλαστικό - Χαλκός / Aluminium - Plastic - Copper

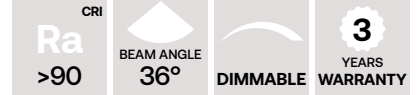

| Code | Barcode | Watt | Amperage mA | Kelvin | Lumen/Watt | Weight (kg) | Color | Packing | MOQ |
|-----------|---------------|------|-------------|--------|------------|-------------|-------|---------|-----|
| 145-59525 | 5207227286995 | 6 | 150 | 3CCT | 80 | 0.079 | BLACK | 1/50 | 1 |
| 145-59531 | 5207227287053 | 6 | 150 | 3CCT | 80 | 0.079 | WHITE | 1/50 | 1 |

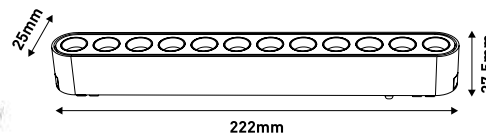

3CCT

(2700K 4300K 6000K)

Ultra Slim 12W 36°



HAISRI
LED Driver

Volt DC 40V · LED Type SMD3030 · Chip Brand Epistar
Start Time 0.5 sec · PF >0.50 · Operating Temperature -20°C / +45°C
Connection Χάλκινο Σημείο Σύνδεσης / Copper Spot Connector
Material Αλουμίνιο - Πλαστικό - Χαλκός / Aluminium - Plastic - Copper

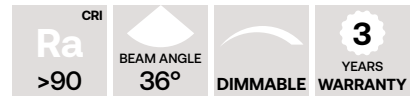

| Code | Barcode | Watt | Amperage mA | Kelvin | Lumen/Watt | Weight (kg) | Color | Packing | MOQ |
|-----------|---------------|------|-------------|--------|------------|-------------|-------|---------|-----|
| 145-59526 | 5207227287008 | 12 | 300 | 3CCT | 80 | 0.144 | BLACK | 1/50 | 1 |
| 145-59532 | 5207227287060 | 12 | 300 | 3CCT | 80 | 0.144 | WHITE | 1/50 | 1 |

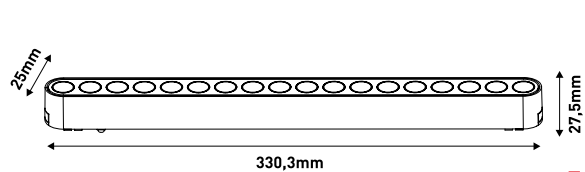

3CCT

(2700K 4300K 6000K)

Ultra Slim 16W 36°



HAISRI
LED Driver

Volt DC 40V · LED Type SMD3030 · Chip Brand Epistar
Start Time 0.5 sec · PF >0.50 · Operating Temperature -20°C / +45°C
Connection Χάλκινο Σημείο Σύνδεσης / Copper Spot Connector
Material Αλουμίνιο - Πλαστικό - Χαλκός / Aluminium - Plastic - Copper

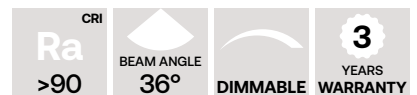

| Code | Barcode | Watt | Amperage mA | Kelvin | Lumen/Watt | Weight (kg) | Color | Packing | MOQ |
|-----------|---------------|------|-------------|--------|------------|-------------|-------|---------|-----|
| 145-59527 | 5207227287015 | 16 | 400 | 3CCT | 80 | 0.214 | BLACK | 1/50 | 1 |

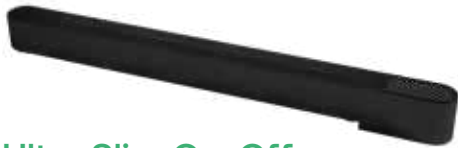

Ultra Slim On-Off



Volt DC 40V

Operating Temperature -20°C / +45°C

Connection Χάλκινο Σημείο Σύνδεσης / Copper Spot Connector

Material Αλουμίνιο - Πλαστικό - Χαλκός / Aluminium - Plastic - Copper



| Code | Barcode | Dimension (mm) | | | Watt | Weight (kg) | Color | Packing | MOQ |
|-----------|---------------|----------------|----|------|------|-------------|-------|---------|-----|
| | | ↔ | ↔ | ↕ | | | | | |
| 145-59540 | 5207227287084 | 290 | 25 | 27.6 | 100 | 0.320 | BLACK | 1/30 | 1 |
| 145-59541 | 5207227287091 | 290 | 25 | 27.6 | 200 | 0.340 | BLACK | 1/30 | 1 |
| 145-59570 | 5207227363542 | 290 | 25 | 27.6 | 100 | 0.320 | WHITE | 1/30 | 1 |
| 145-59571 | 5207227363559 | 290 | 25 | 27.6 | 200 | 0.340 | WHITE | 1/30 | 1 |

Ultra Slim with Triac DIMMABLE

| Code | Barcode | Dimension (mm) | | | Watt | Weight (kg) | Color | Packing | MOQ |
|-----------|---------------|----------------|----|------|------|-------------|-------|---------|-----|
| | | ↔ | ↔ | ↕ | | | | | |
| 145-59542 | 5207227287107 | 290 | 25 | 27.6 | 100 | 0.338 | BLACK | 1/30 | 1 |
| 145-59543 | 5207227287114 | 345 | 25 | 27.6 | 200 | 0.460 | BLACK | 1/30 | 1 |
| 145-59572 | 5207227363566 | 290 | 25 | 27.6 | 100 | 0.338 | WHITE | 1/30 | 1 |
| 145-59573 | 5207227363573 | 345 | 25 | 27.6 | 150 | 0.460 | WHITE | 1/30 | 1 |

Ultra Slim DALI



| Code | Barcode | Dimension (mm) | | | Watt | Weight (kg) | Color | Packing | MOQ |
|-----------|---------------|----------------|----|------|------|-------------|-------|---------|-----|
| | | ↔ | ↔ | ↕ | | | | | |
| 145-59544 | 5207227287121 | 290 | 25 | 27.6 | 100 | 0.345 | BLACK | 1/30 | 1 |
| 145-59545 | 5207227287138 | 345 | 25 | 27.6 | 200 | 0.465 | BLACK | 1/30 | 1 |
| 145-59574 | 5207227363580 | 290 | 25 | 27.6 | 100 | 0.345 | WHITE | 1/30 | 1 |
| 145-59575 | 5207227363597 | 345 | 25 | 27.6 | 150 | 0.465 | WHITE | 1/30 | 1 |

1 Εγκατάσταση

Αφαιρέστε το καπάκι

2

Ευθυγραμμίστε την κάτω χάλκινη επαφή με τη ράγα και τοποθετήστε την κάθετα.

3

Βεβαιωθείτε ότι η τροφοδοσία ρεύματος είναι σταθερά στερεωμένη και εντελώς επίπεδη στη ράγα

4

Εισάγετε το κάτω κάλυμμα του τροφοδοτικού στο καλώδιο

Στερέωση του κάτω καλύμματος του τροφοδοτικού με βίδα

5

Συνδέστε το καλώδιο

6

Ευθυγραμμίστε την υποδοχή του κάτω καλύμματος με το επάνω κάλυμμα των εξαρτημάτων

On Power

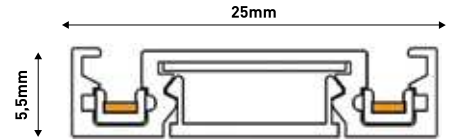

Ultra Slim



Volt DC 40V
 Operating Temperature -20°C / +45°C
 Connection Χάλκινο Σημείο Σύνδεσης / Copper Spot Connector
 Material Αλουμίνιο - Πλαστικό - Χαλκός / Aluminium - Plastic - Copper



| Code | Barcode | Dimension (mm) ↕ ↔ ↕ | Weight (kg) | Color | Packing | MOQ |
|-----------|---------------|-------------------------|-------------|-------|---------|-----|
| 145-59550 | 5207227287145 | 1000 x 25 x 5.5 | 0.253 | BLACK | 1/10 | 1 |
| 145-59551 | 5207227287152 | 1500 x 25 x 5.5 | 0.384 | BLACK | 1/10 | 1 |
| 145-59552 | 5207227287169 | 2000 x 25 x 5.5 | 0.512 | BLACK | 1/10 | 1 |
| 145-59561 | 5207227287251 | 1000 x 25 x 5.5 | 0.253 | WHITE | 1/10 | 1 |
| 145-59562 | 5207227287268 | 2000 x 25 x 5.5 | 0.512 | WHITE | 1/10 | 1 |



Ultra Slim Καθετος - In jointed



Volt DC 40V
 Operating Temperature -20°C / +45°C
 Connection Χάλκινο Σημείο Σύνδεσης / Copper Spot Connector
 Material Αλουμίνιο - Πλαστικό - Χαλκός / Aluminium - Plastic - Copper



| Code | Barcode | Weight (kg) | Color | Packing | MOQ |
|-----------|---------------|-------------|-------|---------|-----|
| 145-59557 | 5207227287213 | 0.015 | BLACK | 1/50 | 1 |
| 145-59567 | 5207227287312 | 0.015 | WHITE | 1/50 | 1 |



Ultra Slim Καμπύλη - Curve



Volt DC 40V
 Operating Temperature -20°C / +45°C
 Connection Χάλκινο Σημείο Σύνδεσης / Copper Spot Connector
 Material Αλουμίνιο - Πλαστικό - Χαλκός / Aluminium - Plastic - Copper



| Code | Barcode | Weight (kg) | Color | Packing | MOQ |
|-----------|---------------|-------------|-------|---------|-----|
| 145-59580 | 5207227403040 | 0.010 | BLACK | 1/200 | 1 |
| 145-59569 | 5207227403064 | 0.010 | WHITE | 1/200 | 1 |



Ultra Slim Γωνία - Angle 90°

IP20 CE

Volt DC 40V

Operating Temperature -20°C / +45°C

Connection Χάλκινο Σημείο Σύνδεσης / Copper Spot Connector

Material Αλουμίνιο - Πλαστικό - Χαλκός / Aluminium - Plastic - Copper

3
YEARS
WARRANTY

| Code | Barcode | Weight (kg) | Color | Packing | MOQ |
|-----------|---------------|-------------|-------|---------|-----|
| 145-59554 | 5207227287183 | 0.012 | BLACK | 1/50 | 1 |
| 145-59564 | 5207227287282 | 0.012 | WHITE | 1/50 | 1 |



Ultra Slim Ταφ - Type T

IP20 CE

Volt DC 40V

Operating Temperature -20°C / +45°C

Connection Χάλκινο Σημείο Σύνδεσης / Copper Spot Connector

Material Αλουμίνιο - Πλαστικό - Χαλκός / Aluminium - Plastic - Copper

3
YEARS
WARRANTY

| Code | Barcode | Weight (kg) | Color | Packing | MOQ |
|-----------|---------------|-------------|-------|---------|-----|
| 145-59555 | 5207227287190 | 0.026 | BLACK | 1/50 | 1 |
| 145-59565 | 5207227287299 | 0.026 | WHITE | 1/50 | 1 |



Ultra Slim ΣΤΑΥΡΟΣ - Cross

IP20 CE

Volt DC 40V

Operating Temperature -20°C / +45°C

Connection Χάλκινο Σημείο Σύνδεσης / Copper Spot Connector

Material Αλουμίνιο - Πλαστικό - Χαλκός / Aluminium - Plastic - Copper

3
YEARS
WARRANTY

| Code | Barcode | Weight (kg) | Color | Packing | MOQ |
|-----------|---------------|-------------|-------|---------|-----|
| 145-59556 | 5207227287206 | 0.032 | BLACK | 1/50 | 1 |
| 145-59566 | 5207227287305 | 0.032 | WHITE | 1/50 | 1 |



Ultra Slim Τάπα - End cup



Operating Temperature -20°C / +45°C
Material Πλαστικό / Plastic



| Code | Barcode | Weight (kg) | Color | Packing | MOQ |
|-----------|---------------|-------------|-------|---------|-----|
| 145-59553 | 5207227287176 | 0.001 | BLACK | 1/200 | 1 |
| 145-59563 | 5207227287275 | 0.001 | WHITE | 1/10 | 1 |



Ultra Slim Τύπου - Type "I"

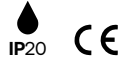

Volt DC 40V
Operating Temperature -20°C / +45°C
Connection Χάλκινο Σημείο Σύνδεσης / Copper Spot Connector
Material Αλουμίνιο - Πλαστικό - Χαλκός / Aluminium - Plastic - Copper



| Code | Barcode | Weight (kg) | Color | Packing | MOQ |
|-----------|---------------|-------------|-------|---------|-----|
| 145-59558 | 5207227287220 | 0.005 | BLACK | 1/50 | 1 |
| 145-59568 | 5207227287329 | 0.005 | WHITE | 1/50 | 1 |



Ultra Slim Ρυθμιζόμενος - Adjustable



Volt DC 40V
Operating Temperature -20°C / +45°C
Connection Χάλκινο Σημείο Σύνδεσης / Copper Spot Connector
Material Αλουμίνιο - Πλαστικό - Χαλκός / Aluminium - Plastic - Copper



| Code | Barcode | Watt | Length (mm) | Weight (kg) | Color | Packing | MOQ |
|-----------|---------------|------|-------------|-------------|-------|---------|-----|
| 145-59559 | 5207227287237 | 6 | 222 | 0.078 | BLACK | 1/30 | 1 |
| 145-59560 | 5207227287244 | 12 | 114,5 | 0.135 | BLACK | 1/30 | 1 |

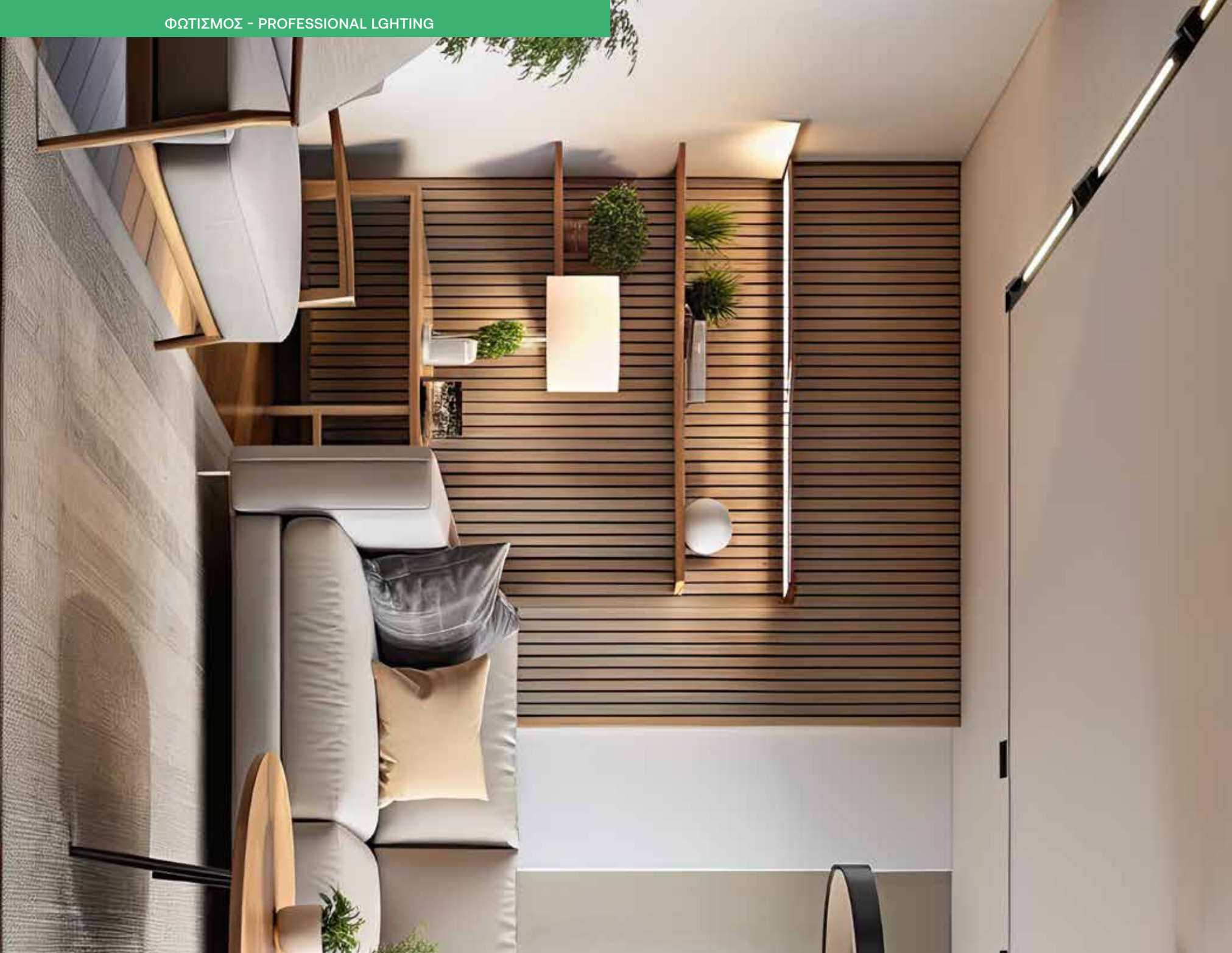



Μαγνητική Ράγα
48W

Magnetic Track
48W

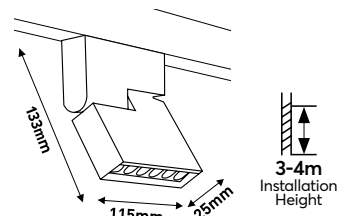

Tyanshint
LED Driver

LED 24°



FLICKER
FREE



25.000h



ON
OFF
15.000



IP20



CLASS II



CE



G



Volt DC 48V • LED Type SMD3030 • Chip Brand Osram
Start Time 0.5 sec • PF >0.50 • Operating Temperature -20°C / +45°C
Connection Μαγνητική Επαφή / Magnetik Contact
Material Αλουμίνιο - Πλαστικό - Χαλκός / Aluminium - Plastic - Copper

| | | |
|-----------------------------------|--------------------------|-------------------------------|
| CRI Ra >80 | BEAM ANGLE 24° | 3 YEARS WARRANTY |
|-----------------------------------|--------------------------|-------------------------------|

| Code | Barcode | Watt | Amperage mA | Kelvin | Lumen/Watt | Weight (kg) | Color | Packing | MOQ |
|-----------|---------------|------|----------------|--------|------------|----------------|-------|---------|-----|
| 145-59932 | 5207227151552 | 6 | 300 | 4000 | 66 | 0.280 | BLACK | 1/20 | 1 |
| 145-59933 | 5207227151569 | 12 | 600 | 4000 | 66 | 0.480 | BLACK | 1/20 | 1 |
| 145-59936 | 5207227259234 | 6 | 300 | 3000 | 66 | 0.280 | BLACK | 1/20 | 1 |
| 145-59937 | 5207227259241 | 12 | 600 | 3000 | 66 | 0.480 | BLACK | 1/20 | 1 |



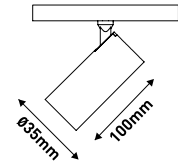

3CCT

(2700K 4000K 6000K)

LED 24°

Tyanshint

LED Driver



Volt DC 48V • LED Type COB • Chip Brand Sanna
 Start Time 0.5 sec • PF >0.50 • Operating Temperature -20°C / +45°C
 Connection Μαγνητική Επαφή / Magnetik Contact
 Material Αλουμίνιο - Πλαστικό - Χαλκός / Aluminium - Plastic - Copper

CRI **Ra >90** BEAM ANGLE **24°** **3** YEARS WARRANTY

| Code | Barcode | Watt | Amperage mA | Kelvin | Lumen/Watt | Weight (kg) | Color | Packing | MOQ |
|-----------|---------------|------|-------------|--------|------------|-------------|-------|---------|-----|
| 145-59942 | 5207227264719 | 7 | 150 | 3CCT | 50 | 0.165 | BLACK | 1/20 | 1 |
| 145-59938 | 5207227263378 | 7 | 150 | 3CCT | 50 | 0.165 | BLACK | 1/20 | 1 |
| 145-59939 | 5207227263392 | 7 | 150 | 3CCT | 50 | 0.165 | BLACK | 1/20 | 1 |

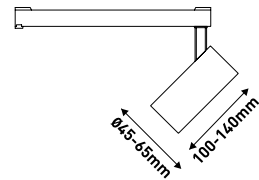

LED 24°

Tyanshint

LED Driver

● Μαύρο/Black



Volt DC 48V • LED Type COB • Chip Brand Goym
 Start Time 0.5 sec • PF >0.50 • Operating Temperature -20°C / +45°C
 Connection Μαγνητική Επαφή / Magnetik Contact
 Material Αλουμίνιο - Πλαστικό - Χαλκός / Aluminium - Plastic - Copper

CRI **Ra >90** BEAM ANGLE **24°** **3** YEARS WARRANTY

| Code | Barcode | Dimension Ø (mm) † | Watt | Amperage mA | Kelvin | Lumen/Watt | Weight (kg) | Packing | MOQ |
|-----------|---------------|--------------------|------|-------------|--------|------------|-------------|---------|-----|
| 145-59930 | 5207227151538 | 45 x 100 | 12 | 300 | 4000 | 69 | 0.200 | 1/20 | 1 |
| 145-59931 | 5207227151545 | 65 x 140 | 18 | 450 | 4000 | 83 | 0.400 | 1/20 | 1 |
| 145-59934 | 5207227259210 | 45 x 100 | 12 | 300 | 3000 | 69 | 0.200 | 1/20 | 1 |
| 145-59935 | 5207227259227 | 65 x 140 | 18 | 450 | 3000 | 83 | 0.400 | 1/20 | 1 |

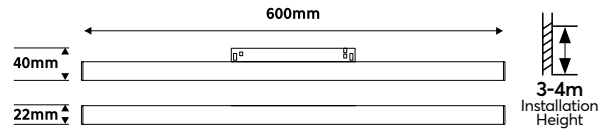

Sheng jie
LED Driver

Γραμμικό - Linear Flood 120°



Volt DC 48V • LED Type SMD2835 • Chip Brand Bridgelux* Chip Brand Osram**
Start Time 0.5 sec • PF >0.50 • Operating Temperature -20°C / +45°C
Connection Μαγνητική Επαφή / Magnetik Contact
Material Αλουμίνιο - Πλαστικό - Χαλκός / Aluminium - Plastic - Copper

CRI **Ra >80** BEAM ANGLE **120°** **3 YEARS WARRANTY**

| Code | Barcode | Watt | Amperage mA | Kelvin | Lumen/Watt | Weight (kg) | Color | Packing | MOQ |
|-------------|---------------|------|-------------|--------|------------|-------------|-------|---------|-----|
| 145-59950* | 5207227151507 | 20 | 400 | 4000 | 80 | 0.400 | BLACK | 1/25 | 1 |
| 145-59954** | 5207227259166 | 18 | 400 | 3000 | 80 | 0.400 | BLACK | 1/25 | 1 |

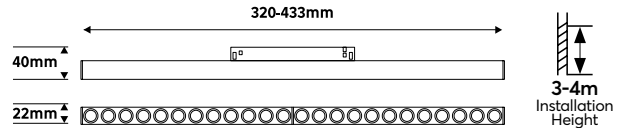

Sheng jie
LED Driver

● Μαύρο/Black

Γραμμικό - Linear Flood 24°



Volt DC 48V • LED Type SMD2835 • Chip Brand Bridgelux* Chip Brand Osram**
Start Time 0.5 sec • PF >0.50 • Operating Temperature -20°C / +45°C
Connection Μαγνητική Επαφή / Magnetik Contact
Material Αλουμίνιο - Πλαστικό - Χαλκός / Aluminium - Plastic - Copper

CRI **Ra >80** BEAM ANGLE **24°** **3 YEARS WARRANTY**

| Code | Barcode | Dimension (mm) | Watt | Amperage mA | Kelvin | Lumen/Watt | Weight (kg) | Packing | MOQ |
|-------------|---------------|----------------|------|-------------|--------|------------|-------------|---------|-----|
| 145-59952* | 5207227151514 | 320 x 22 x 40 | 18 | 350 | 4000 | 80 | 0.250 | 1/25 | 1 |
| 145-59953* | 5207227151521 | 433 x 22 x 40 | 24 | 500 | 4000 | 80 | 0.340 | 1/25 | 1 |
| 145-59955** | 5207227259180 | 320 x 22 x 40 | 18 | 350 | 3000 | 80 | 0.160 | 1/25 | 1 |
| 145-59956** | 5207227259203 | 433 x 22 x 40 | 24 | 500 | 3000 | 80 | 0.270 | 1/25 | 1 |

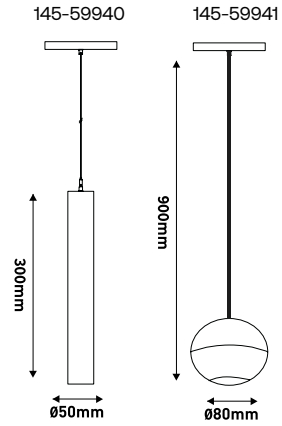

Sheng jie
LED Driver



Κρεμαστό - Pendant 24°



Volt DC 48V • LED Type SMD1313 • Chip Brand Bridgelux
Start Time 0.5 sec • PF >0.50 • Operating Temperature -20°C / +45°C
Connection Μαγνητική Επαφή / Magnetik Contact
Material Αλουμίνιο - Πλαστικό - Χαλκός / Aluminium - Plastic - Copper

| | | |
|--------|------------|------------------|
| CRI | BEAM ANGLE | 3 YEARS WARRANTY |
| Ra >80 | 24° | |

| Code | Barcode | Watt | Amperage mA | Kelvin | Lumen/Watt | Weight (kg) | Color | Packing | MOQ |
|-----------|---------------|------|-------------|--------|------------|-------------|-------|---------|-----|
| 145-59940 | 5207227151576 | 10 | 200 | 4000 | 80 | 0.370 | BLACK | 1/30 | 1 |
| 145-59941 | 5207227151583 | 7 | 150 | 4000 | 80 | 0.280 | BLACK | 1/30 | 1 |



ΦΩΤΙΣΜΟΣ - PROFESSIONAL LIGHTING

Μαγνητική Ράγα Χωνευτή Recessed Magnetic Track



Volt DC 48V • Operating Temperature -20°C / +45°C
 Connection Μαγνητική Επαφή / Magnetik Contact
 Material Αλουμίνιο - Πλαστικό - Χαλκός / Aluminium - Plastic - Copper

| Code | Barcode | Dimension (mm) | | | Weight (kg) | Color | Packing | MOQ |
|-----------|---------------|----------------|----|----|-------------|-------|---------|-----|
| | | ↗ | ↔ | ↘ | | | | |
| 145-59900 | 5207227157165 | 1000 | 64 | 43 | 1.010 | BLACK | 1/5 | 1 |
| 145-59901 | 5207227151590 | 2000 | 64 | 43 | 2.020 | BLACK | 1/5 | 1 |

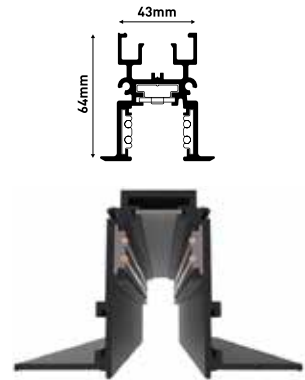

Μαγνητική Ράγα Εξωτερική Surface Mounted Magnetic Track



Volt DC 48V • Operating Temperature -20°C / +45°C
 Connection Μαγνητική Επαφή / Magnetik Contact
 Material Αλουμίνιο - Πλαστικό - Χαλκός / Aluminium - Plastic - Copper

| Code | Barcode | Dimension (mm) | | | Weight (kg) | Color | Packing | MOQ |
|-----------|---------------|----------------|----|----|-------------|-------|---------|-----|
| | | ↗ | ↔ | ↘ | | | | |
| 145-59902 | 5207227157172 | 1000 | 26 | 53 | 0.820 | BLACK | 1/8 | 1 |
| 145-59903 | 5207227151606 | 2000 | 26 | 53 | 1.620 | BLACK | 1/8 | 1 |

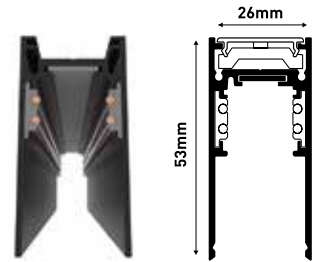

Μαγνητική Ράγα Χωνευτή Μίνι Recessed Mini Magnetic Track



Volt DC 48V • Operating Temperature -20°C / +45°C
 Connection Μαγνητική Επαφή / Magnetik Contact
 Material Αλουμίνιο - Πλαστικό - Χαλκός / Aluminium - Plastic - Copper

| Code | Barcode | Length (m) | Weight (kg) | Color | Packing | MOQ |
|-----------|---------------|------------|-------------|-------|---------|-----|
| | | | | | | |
| 145-59991 | 5207227301353 | 2m | - | BLACK | - | 1 |



Μαγνητική Ράγα Εξωτερική Μίνι Surface Mounted Mini Magnetic Track



Volt DC 48V • Operating Temperature -20°C / +45°C
 Connection Μαγνητική Επαφή / Magnetik Contact
 Material Αλουμίνιο - Πλαστικό - Χαλκός / Aluminium - Plastic - Copper

| Code | Barcode | Length (m) | Weight (kg) | Color | Packing | MOQ |
|-----------|---------------|------------|-------------|-------|---------|-----|
| | | | | | | |
| 145-59993 | 5207227301377 | 2m | - | BLACK | - | 1 |



Τροφοδοτικό - Driver / 100W 48V DC

Volt DC 48V · Operating Temperature -20°C / +45°C
 Connection Μαγνητική Επαφή / Magnetik Contact
 Material Αλουμίνιο - Πλαστικό - Χαλκός / Aluminium - Plastic - Copper

| Code | Barcode | Weight (kg) | Color | Packing | MOQ |
|-----------|---------------|-------------|-------|---------|-----|
| 145-59907 | 5207227151637 | 0.330 | BLACK | 1/30 | 1 |

**Τροφοδοτικό - Driver / 200W 48V DC**

Volt DC 48V · Operating Temperature -20°C / +45°C
 Connection Μαγνητική Επαφή / Magnetik Contact
 Material Αλουμίνιο - Πλαστικό - Χαλκός / Aluminium - Plastic - Copper

| Code | Barcode | Weight (kg) | Color | Packing | MOQ |
|-----------|---------------|-------------|-------|---------|-----|
| 145-59908 | 5207227151644 | 0.420 | BLACK | 1/30 | 1 |

**Τροφοδοσία - Input Power Connector**

Volt DC 48V · Operating Temperature -20°C / +45°C
 Connection Μαγνητική Επαφή / Magnetik Contact
 Material Αλουμίνιο - Πλαστικό - Χαλκός / Aluminium - Plastic - Copper

| Code | Barcode | Weight (kg) | Color | Packing | MOQ |
|-----------|---------------|-------------|-------|---------|-----|
| 145-59904 | 5207227151613 | 0.053 | BLACK | 1/300 | 1 |

**Ενωτικός Σύνδεσμος Flexible
Flexible Power Connector**

Volt DC 48V · Operating Temperature -20°C / +45°C
 Connection Μαγνητική Επαφή / Magnetik Contact
 Material Αλουμίνιο - Πλαστικό - Χαλκός / Aluminium - Plastic - Copper

| Code | Barcode | Weight (kg) | Color | Packing | MOQ |
|-----------|---------------|-------------|-------|---------|-----|
| 145-59905 | 5207227151620 | 0.047 | BLACK | 1/200 | 1 |

**Ενωτικός Σύνδεσμος - Power Connector**

Volt DC 48V · Operating Temperature -20°C / +45°C
 Connection Μαγνητική Επαφή / Magnetik Contact
 Material Αλουμίνιο - Πλαστικό - Χαλκός / Aluminium - Plastic - Copper

| Code | Barcode | Weight (kg) | Color | Packing | MOQ |
|-----------|---------------|-------------|-------|---------|-----|
| 145-59906 | 5207227190971 | 0.045 | BLACK | 1/300 | 1 |



Σταυρός Χωνευτός - Cross Recessed



3
YEARS
WARRANTY

Operating Temperature -20°C / +45°C
Material Αλουμίνιο / Aluminium

| Code | Barcode | Weight (kg) | Color | Packing | MOQ |
|-----------|---------------|-------------|-------|---------|-----|
| 145-59923 | 5207227472978 | 0.230 | BLACK | 1/14 | 1 |



Ταψ Χωνευτό - Recessed Type T



3
YEARS
WARRANTY

Operating Temperature -20°C / +45°C
Material Αλουμίνιο / Aluminium

| Code | Barcode | Weight (kg) | Color | Packing | MOQ |
|-----------|---------------|-------------|-------|---------|-----|
| 145-59924 | 5207227472985 | 0.179 | BLACK | 1/20 | 1 |



43x100x100mm Γωνία Χωνευτή - Recessed Corner 90°



5
YEARS
WARRANTY

Operating Temperature -20°C / +45°C
Material Αλουμίνιο / Aluminium

| Code | Barcode | Weight (kg) | Color | Packing | MOQ |
|-----------|---------------|-------------|-------|---------|-----|
| 145-59910 | 5207227151651 | 0.160 | BLACK | 1/30 | 1 |



43x100x100mm Γωνία Χωνευτή - Recessed Corner 90°



5
YEARS
WARRANTY

Operating Temperature -20°C / +45°C
Material Αλουμίνιο / Aluminium

| Code | Barcode | Weight (kg) | Color | Packing | MOQ |
|-----------|---------------|-------------|-------|---------|-----|
| 145-59911 | 5207227151668 | 0.160 | BLACK | 1/30 | 1 |



43x100x100mm Γωνία Χωνευτή - Recessed Corner 90°



5
YEARS
WARRANTY

Operating Temperature -20°C / +45°C
Material Αλουμίνιο / Aluminium

| Code | Barcode | Weight (kg) | Color | Packing | MOQ |
|-----------|---------------|-------------|-------|---------|-----|
| 145-59912 | 5207227151675 | 0.160 | BLACK | 1/30 | 1 |



64x100x100mm Γωνία Εσωτερική - Surface Corner 90°

IP20 CE

5
YEARS
WARRANTY

Operating Temperature -20°C / +45°C
Material Αλουμίνιο / Aluminium

| Code | Barcode | Weight (kg) | Color | Packing | MOQ |
|-----------|---------------|-------------|-------|---------|-----|
| 145-59913 | 5207227151682 | 0.150 | BLACK | 1/30 | 1 |



Γωνία Εξωτερική - Surface Corner

IP20

3
YEARS
WARRANTY

Operating Temperature -20°C / +45°C
Material Αλουμίνιο / Aluminium

| Code | Barcode | Weight (kg) | Color | Packing | MOQ |
|-----------|---------------|-------------|-------|---------|-----|
| 145-59922 | 5207227472961 | 0.077 | BLACK | 1/30 | 1 |



64x100x100mm Γωνία Εξωτερική - Surface Corner 90°

IP20 CE

5
YEARS
WARRANTY

Operating Temperature -20°C / +45°C
Material Αλουμίνιο / Aluminium

| Code | Barcode | Weight (kg) | Color | Packing | MOQ |
|-----------|---------------|-------------|-------|---------|-----|
| 145-59914 | 5207227151699 | 0.150 | BLACK | 1/50 | 1 |



Σταυρός Εξωτερικός - Surface Corner

IP20

3
YEARS
WARRANTY

Operating Temperature -20°C / +45°C
Material Αλουμίνιο / Aluminium

| Code | Barcode | Weight (kg) | Color | Packing | MOQ |
|-----------|---------------|-------------|-------|---------|-----|
| 145-59925 | 5207227472992 | 0.200 | BLACK | 1/14 | 1 |



Ταφ Εξωτερικός - Corner Type T

IP20

3
YEARS
WARRANTY

Operating Temperature -20°C / +45°C
Material Αλουμίνιο / Aluminium

| Code | Barcode | Weight (kg) | Color | Packing | MOQ |
|-----------|---------------|-------------|-------|---------|-----|
| 145-59926 | 5207227473005 | 0.153 | BLACK | 1/20 | 1 |



70x7x2mm
Σύνδεσμος Χωνευτής - Conjunction Recessed



Volt DC 48V · Operating Temperature -20°C / +45°C
 Connection Μαγνητική Επαφή / Magnetik Contact
 Material Αλουμίνιο - Πλαστικό - Χαλκός / Aluminium - Plastic - Copper



| | Barcode | Weight (kg) | Color | Packing | MOQ |
|------------------|---------------|-------------|-------|---------|-----|
| 145-59915 | 5207227151705 | 0.010 | BLACK | 1/100 | 1 |

50x20x2mm
Τάπα Χωνευτής - End cup Recessed



Operating Temperature -20°C / +45°C
 Material Πλαστικό / Plastic



| Code | Barcode | Weight (kg) | Color | Packing | MOQ |
|------------------|---------------|-------------|-------|---------|-----|
| 145-59919 | 5207227190995 | 0.009 | BLACK | 1/300 | 1 |

50x20x2mm
Τάπα Χωνευτής σετ 2 Τεμαχίων
End cup Recessed set 2 Pcs



Operating Temperature -20°C / +45°C
 Material Πλαστικό / Plastic



| Code | Barcode | Weight (kg) | Color | Packing | MOQ |
|------------------|---------------|-------------|-------|---------|-----|
| 145-59920 | 5207227191008 | 0.009 | BLACK | 1/300 | 1 |

50x20x2mm
Βάση Οροφής - Ceiling Base



Operating Temperature -20°C / +45°C
 Material Μεταλλικό / Metallic



| Code | Barcode | Weight (kg) | Color | Packing | MOQ |
|------------------|---------------|-------------|-------|---------|-----|
| 145-59921 | 5207227205675 | 0.010 | BLACK | 1/500 | 1 |



50x20x2mm Σύνδεσμος Εξωτερικής - Conjunction Surface



Volt DC 48V

Operating Temperature -20°C / +45°C

Connection Μαγνητική Επαφή / Magnetik Contact

Material Αλουμίνιο - Πλαστικό - Χαλκός / Aluminium - Plastic - Copper



| Code | Barcode | Weight (kg) | Color | Packing | MOQ |
|-----------|---------------|-------------|-------|---------|-----|
| 145-59916 | 5207227151712 | 0.020 | BLACK | 1/100 | 1 |



2000x1,5x1,5mm Ντίζα - Suspending Wire



Operating Temperature -20°C / +45°C

Material Αλουμίνιο-Πλαστικό/Aluminium-Plastic



| Code | Barcode | Weight (kg) | Color | Packing | MOQ |
|-----------|---------------|-------------|-------|---------|-----|
| 145-59917 | 5207227151729 | 0.080 | BLACK | 1/100 | 1 |



50x20x2mm Ντίζα Σταθερή - Suspension Rod Stable



Operating Temperature -20°C / +45°C

Material Αλουμίνιο-Πλαστικό/Aluminium-Plastic



| Code | Barcode | Weight (kg) | Color | Packing | MOQ |
|-----------|---------------|-------------|-------|---------|-----|
| 145-59918 | 5207227190988 | 0.472 | BLACK | 1/50 | 1 |



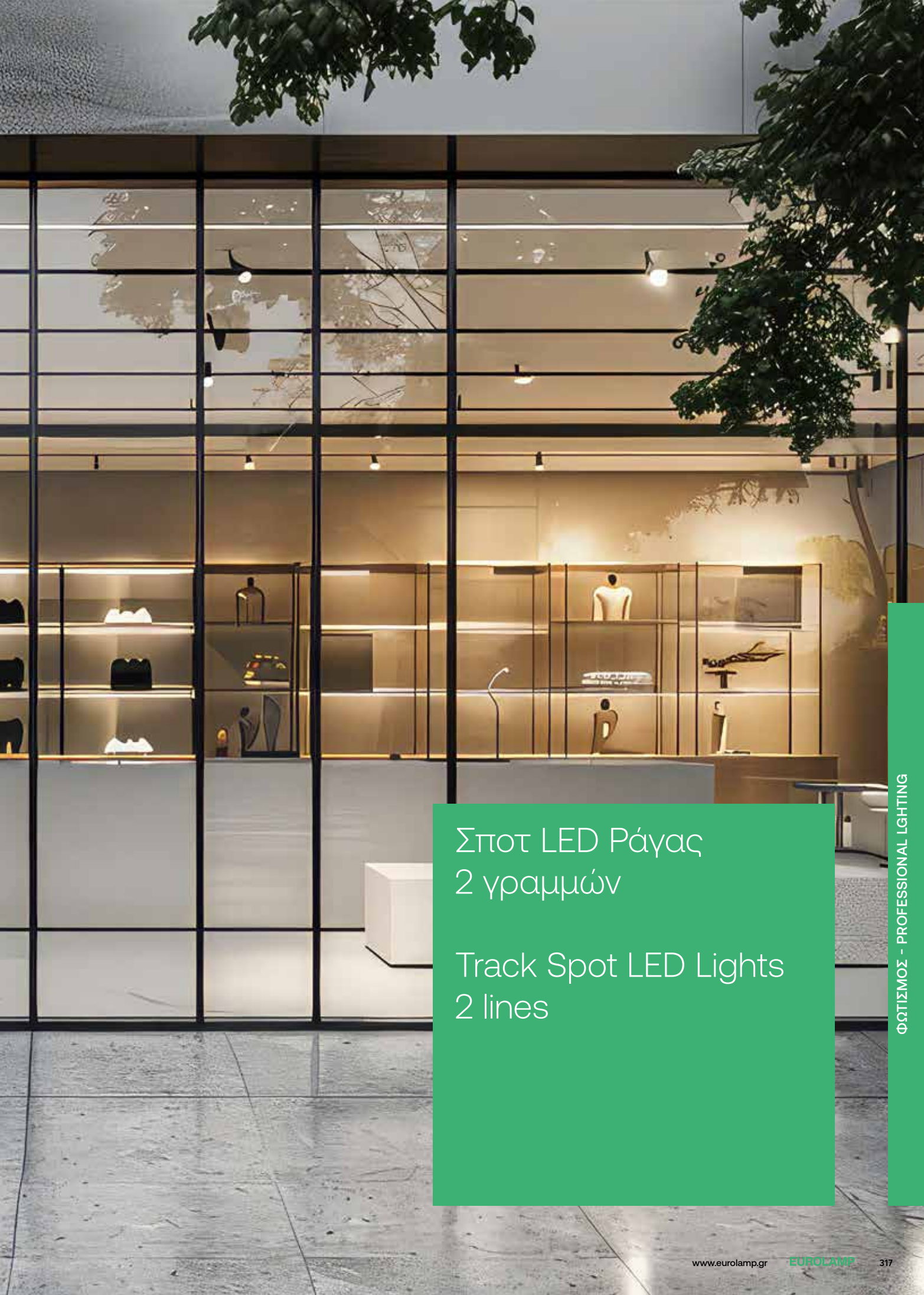

Σποτ LED Ράγας
2 γραμμών

Track Spot LED Lights
2 lines

ΣΠΟΤ LED ΡΑΓΑΣ 2 ΓΡΑΜΜΩΝ - TRACK SPOT LED LIGHTS 2 LINES

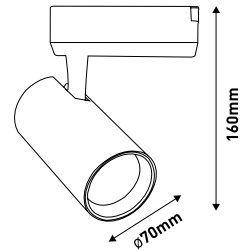

Ø70X160



Volt DC 100-265V 50/60Hz · LED Type SMD1919 · Chip Brand Hongli
 Start Time 1 sec · PF >0.50 · Operating Temperature -20°C / +45°C
 Connection Αντάπτορας 2 Καλωδίων / 2 Wire Adaptor
 Material Αλουμίνιο - Πλαστικό - Χαλκός / Aluminium - Plastic - Copper

CRI **Ra >80** BEAM ANGLE **24°** **2 YEARS WARRANTY**

| Code | Barcode | Watt | Amperage mA | Kelvin | Lumen/Watt | Weight (kg) | Color | Packing | MOQ |
|-----------|---------------|------|-------------|--------|------------|-------------|-------|---------|-----|
| 145-59050 | 5207227205781 | 20 | 220 | 4000 | 90 | 0.325 | WHITE | 1/30 | 1 |
| 145-59051 | 5207227205804 | 20 | 220 | 4000 | 90 | 0.325 | BLACK | 1/40 | 1 |
| 145-59052 | 5207227158407 | 20 | 220 | 3000 | 90 | 0.325 | WHITE | 1/24 | 1 |
| 145-59053 | 5207227158414 | 20 | 220 | 3000 | 90 | 0.325 | BLACK | 1/24 | 1 |

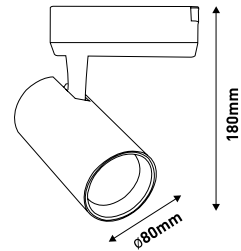

Ø80X160



Volt DC 100-265V 30/60Hz · LED Type SMD1919 · Chip Brand Hongli
 Start Time 1 sec · PF >0.50 · Operating Temperature -20°C / +45°C
 Connection Αντάπτορας 2 Καλωδίων / 2 Wire Adaptor
 Material Αλουμίνιο - Πλαστικό - Χαλκός / Aluminium - Plastic - Copper

CRI **Ra >80** BEAM ANGLE **24°** **2 YEARS WARRANTY**

| Code | Barcode | Watt | Amperage mA | Kelvin | Lumen/Watt | Weight (kg) | Color | Packing | MOQ |
|-----------|---------------|------|-------------|--------|------------|-------------|-------|---------|-----|
| 145-59054 | 5207227220272 | 30 | 220 | 4000 | 90 | 0.390 | WHITE | 1/40 | 1 |
| 145-59055 | 5207227264238 | 30 | 220 | 4000 | 90 | 0.390 | BLACK | 1/20 | 1 |
| 145-59056 | 5207227158421 | 30 | 220 | 3000 | 90 | 0.390 | WHITE | 1/20 | 1 |
| 145-59057 | 5207227158438 | 30 | 220 | 3000 | 90 | 0.390 | BLACK | 1/20 | 1 |

ΦΩΤΙΣΜΟΣ - PROFESSIONAL LIGHTING

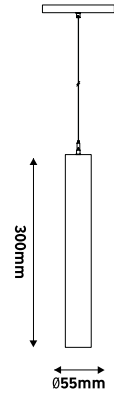

RNS
LED Driver



Ø55X300



LED Type SMD1350 • Chip Brand Hongli • Volt 100-265V 50/60Hz
Start Time 1 sec • PF >0,50 • Operating Temperature -20°C / +45°C
Connection Αντάπτορας 2 Καλωδίων / 2 Wire Adaptor
Production Material Αλουμίνιο - Πλαστικό - Χαλκός / Aluminium - Plastic - Copper

| | | |
|-------------------------|--------------------------|-------------------------------|
| CRI Ra >80 | BEAM ANGLE 24° | 2 YEARS WARRANTY |
|-------------------------|--------------------------|-------------------------------|

| Code | Barcode | Watt | Amperage mA | Kelvin | Lumen/Watt | Weight (kg) | Color | Packing | MOQ |
|-----------|---------------|------|-------------|--------|------------|-------------|-------|---------|-----|
| 145-59040 | 5207227264191 | 10 | 300 | 4000 | 90 | 0.530 | WHITE | 1/24 | 1 |
| 145-59041 | 5207227264207 | 10 | 300 | 4000 | 90 | 0.530 | BLACK | 1/24 | 1 |

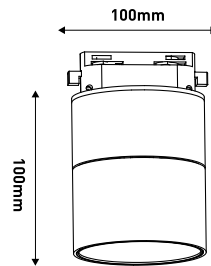

EAGLERISE
LED Driver



Ø100X100



LED Type COB • Chip Brand Cree • Volt 220-240V 50/60Hz
Start Time 0.5 sec • PF >0,50 • Operating Temperature -20°C / +45°C
Connection Αντάπτορας 2 Καλωδίων / 2 Wire Adaptor
Production Material Αλουμίνιο - Πλαστικό - Χαλκός / Aluminium - Plastic - Copper

| | | |
|-------------------------|--------------------------|-------------------------------|
| CRI Ra >80 | BEAM ANGLE 24° | 2 YEARS WARRANTY |
|-------------------------|--------------------------|-------------------------------|

| Code | Barcode | Watt | Amperage mA | Kelvin | Lumen/Watt | Weight (kg) | Color | Packing | MOQ |
|-----------|---------------|------|-------------|--------|------------|-------------|-------|---------|-----|
| 145-59058 | 5207227151156 | 12 | 250 | 4000 | 85 | 1.100 | WHITE | 1/20 | 1 |
| 145-59059 | 5207227151163 | 12 | 250 | 4000 | 85 | 1.100 | BLACK | 1/20 | 1 |



GU10 Ø53x200

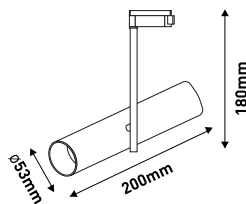

Volt 220-240V 50/60Hz
 Operating Temperature -20°C / +45°C
 Connection Αντάπτορας 2 Καλωδίων / 2 Wire Adaptor
 Material Αλουμίνιο - Πλαστικό - Χαλκός / Aluminium - Plastic - Copper



| Code | Barcode | Watt | Weight (kg) | Color | Packing | MOQ |
|-----------|---------------|-----------|-------------|-------|---------|-----|
| 145-59075 | 520722715118 | MAX 7 LED | 0.750 | WHITE | 1/20 | 1 |
| 145-59085 | 5207227151125 | MAX 7 LED | 0.750 | BLACK | 1/20 | 1 |



GU10 Ø60mm 4cm

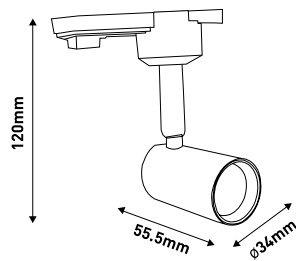

Volt 220-240V 50/60Hz
 Operating Temperature -20°C / +45°C
 Connection Αντάπτορας 2 Καλωδίων / 2 Wire Adaptor
 Material Αλουμίνιο - Πλαστικό - Χαλκός / Aluminium - Plastic - Copper



| Code | Barcode | Watt | Weight (kg) | Color | Packing | MOQ |
|-----------|---------------|-----------|-------------|-------|---------|-----|
| 145-59070 | 5207227220296 | MAX 7 LED | 0.122 | WHITE | 1/100 | 1 |
| 145-59080 | 5207227264283 | MAX 7 LED | 0.122 | BLACK | 1/100 | 1 |



GU10 Ø60x100

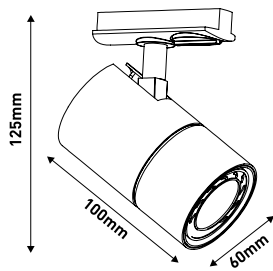

Volt 220-240V 50/60Hz
 Operating Temperature -20°C / +45°C
 Connection Αντάπτορας 2 Καλωδίων / 2 Wire Adaptor
 Material Αλουμίνιο - Πλαστικό - Χαλκός / Aluminium - Plastic - Copper



| Code | Barcode | Watt | Weight (kg) | Color | Packing | MOQ |
|-----------|---------------|-----------|-------------|-------|---------|-----|
| 145-59073 | 5207227264269 | MAX 7 LED | 0.170 | WHITE | 1/24 | 1 |
| 145-59083 | 5207227264306 | MAX 7 LED | 0.170 | BLACK | 1/24 | 1 |



GU10 30x30mm 4cm

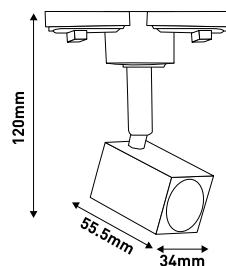

Volt 220-240V 50/60Hz
 Operating Temperature -20°C / +45°C
 Connection Αντάπτορας 2 Καλωδίων / 2 Wire Adaptor
 Material Αλουμίνιο - Πλαστικό - Χαλκός / Aluminium - Plastic - Copper



| Code | Barcode | Watt | Weight (kg) | Color | Packing | MOQ |
|-----------|---------------|-----------|-------------|-------|---------|-----|
| 145-59071 | 5207227264245 | MAX 7 LED | 0.122 | WHITE | 1/100 | 1 |
| 145-59081 | 5207227264290 | MAX 7 LED | 0.122 | BLACK | 1/100 | 1 |



GU10 30x30mm 12cm

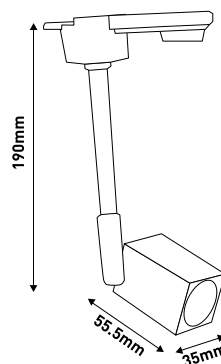

Volt 220-240V 50/60Hz
 Operating Temperature -20°C / +45°C
 Connection Αντάπτορας 2 Καλωδίων / 2 Wire Adaptor
 Material Αλουμίνιο - Πλαστικό - Χαλκός / Aluminium - Plastic - Copper



| Code | Barcode | Watt | Weight (kg) | Color | Packing | MOQ |
|-----------|---------------|-----------|-------------|-------|---------|-----|
| 145-59072 | 5207227264252 | MAX 7 LED | 0.170 | WHITE | 1/20 | 1 |



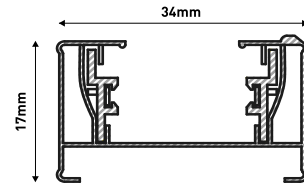
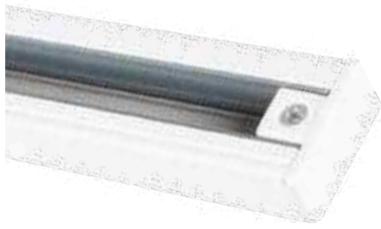

Universal 2 Γραμμών 1, 2 & 3m - Universal 2 line 1, 2 & 3m



Volt 220-240V 50/60Hz

Operating Temperature -20°C / +45°C

Connection Αντάπτορας 2 Καλωδίων / 2 Wire Adaptor

Material Αλουμίνιο - Πλαστικό - Χαλκός / Aluminium - Plastic - Copper



| Code | Barcode | Dimension (mm) | | | Weight (kg) | Color | Packing | MOQ |
|-----------|---------------|----------------|------|----|-------------|-------|---------|-----|
| | | ↗ | ↔ | ↘ | | | | |
| 145-59000 | 5207227264467 | 1000 x | 34 x | 17 | 0.450 | WHITE | 1/20 | 1 |
| 145-59001 | 5207227220258 | 2000 x | 34 x | 17 | 0.622 | WHITE | 1/20 | 1 |
| 145-59011 | 5207227474125 | 3000 x | 34 x | 17 | 0,930 | WHITE | 1/10 | 1 |
| 145-59020 | 5207227220210 | 1000 x | 34 x | 17 | 0.450 | BLACK | 1/20 | 1 |
| 145-59021 | 5207227220234 | 2000 x | 34 x | 17 | 0.622 | BLACK | 1/20 | 1 |
| 145-59031 | 5207227474149 | 3000 x | 34 x | 17 | 0,930 | BLACK | 1/10 | 1 |





Τροφοδοσία 2 Γραμμών 3cm - Power 2 line 3m



Volt 220-240V 50/60Hz

Operating Temperature -20°C / +45°C

Connection Κλέμμα / Terminal Block

Material Αλουμίνιο - Πλαστικό - Χαλκός / Aluminium - Plastic - Copper



| Code | Barcode | Weight (kg) | Color | Packing | MOQ |
|-----------|---------------|-------------|-------|---------|-----|
| 145-59002 | 5207227263712 | 0.048 | WHITE | 1/20 | 1 |
| 145-59022 | 5207227263798 | 0.048 | BLACK | 1/20 | 1 |

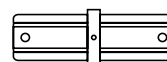

Σύνδεσμος - Conjunction



Volt 220-240V 50/60Hz

Operating Temperature -20°C / +45°C

Connection Αντάπτορας 2 Καλωδίων / 2 Wire Adaptor

Material Αλουμίνιο - Πλαστικό - Χαλκός / Aluminium - Plastic - Copper



| Code | Barcode | Weight (kg) | Color | Packing | MOQ |
|-----------|---------------|-------------|-------|---------|-----|
| 145-59003 | 5207227263729 | 0.025 | WHITE | 1/20 | 1 |
| 145-59023 | 5207227240959 | 0.025 | BLACK | 1/20 | 1 |

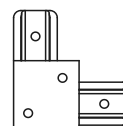

Σύνδεσμος Γωνία - Conjunction Corner 90°



Volt 220-240V 50/60Hz

Operating Temperature -20°C / +45°C

Connection Αντάπτορας 2 Καλωδίων / 2 Wire Adaptor

Material Αλουμίνιο - Πλαστικό - Χαλκός / Aluminium - Plastic - Copper



| Code | Barcode | Weight (kg) | Color | Packing | MOQ |
|-----------|---------------|-------------|-------|---------|-----|
| 145-59004 | 5207227263736 | 0.025 | WHITE | 1/20 | 1 |
| 145-59024 | 5207227263804 | 0.025 | BLACK | 1/20 | 1 |



Σύνδεσμος Γωνία Σπирάλ - Conjunction Spiral Corner 90°

IP20 CE

Volt 220-240V 50/60Hz

Operating Temperature -20°C / +45°C

Connection Αντάπτορας 2 Καλωδίων / 2 Wire Adaptor

Material Αλουμίνιο - Πλαστικό - Χαλκός / Aluminium - Plastic - Copper

5
YEARS
WARRANTY

| Code | Barcode | Weight (kg) | Color | Packing | MOQ |
|-----------|---------------|-------------|-------|---------|-----|
| 145-59005 | 5207227263743 | 0.105 | WHITE | 1/300 | 1 |
| 145-59025 | 5207227263811 | 0.105 | BLACK | 1/300 | 1 |

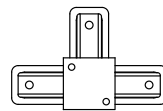

Σύνδεσμος Ταφ - Conjunction Type T

IP20 CE

Volt 220-240V 50/60Hz

Operating Temperature -20°C / +45°C

Connection Αντάπτορας 2 Καλωδίων / 2 Wire Adaptor

Material Αλουμίνιο - Πλαστικό - Χαλκός / Aluminium - Plastic - Copper

5
YEARS
WARRANTY

| Code | Barcode | Weight (kg) | Color | Packing | MOQ |
|-----------|---------------|-------------|-------|---------|-----|
| 145-59006 | 5207227263750 | 0.031 | WHITE | 1/50 | 1 |
| 145-59026 | 5207227263828 | 0.031 | BLACK | 1/50 | 1 |

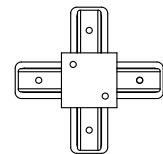

Σύνδεσμος Σταυρός - Conjunction type Cross

IP20 CE

Volt 220-240V 50/60Hz

Operating Temperature -20°C / +45°C

Connection Αντάπτορας 2 Καλωδίων / 2 Wire Adaptor

Material Αλουμίνιο - Πλαστικό - Χαλκός / Aluminium - Plastic - Copper

5
YEARS
WARRANTY

| Code | Barcode | Weight (kg) | Color | Packing | MOQ |
|-----------|---------------|-------------|-------|---------|-----|
| 145-59007 | 5207227263767 | 0.038 | WHITE | 1/50 | 1 |
| 145-59027 | 5207227263835 | 0.038 | BLACK | 1/50 | 1 |



Αντάπτορας με Καλώδιο - Adaptor with Wire

IP20 CE

Volt 220-240V 50/60Hz
 Operating Temperature -20°C / +45°C
 Connection Αντάπτορας 2 Καλωδίων / 2 Wire Adaptor
 Material Αλουμίνιο - Πλαστικό - Χαλκός / Aluminium - Plastic - Copper

5
 YEARS
 WARRANTY

| Code | Barcode | Weight (kg) | Color | Packing | MOQ |
|-----------|---------------|-------------|-------|---------|-----|
| 145-59010 | 5207227191435 | 0.190 | WHITE | 1/300 | 1 |
| 145-59030 | 5207227191442 | 0.190 | BLACK | 1/300 | 1 |



Τερματικό - Terminal

IP20 CE

Volt 220-240V 50/60Hz
 Operating Temperature -20°C / +45°C
 Material Πλαστικό / Plastic

5
 YEARS
 WARRANTY

| Code | Barcode | Weight (kg) | Color | Packing | MOQ |
|-----------|---------------|-------------|-------|---------|-----|
| 145-59008 | 5207227263774 | 0.031 | WHITE | 1/50 | 1 |
| 145-59028 | 5207227263842 | 0.031 | BLACK | 1/50 | 1 |



Ντιζα με Ροζετα - Suspending Wire Fixture with Rosette

IP20

Volt 220-240V 50/60Hz
 Operating Temperature -20°C / +45°C
 Connection Αντάπτορας 2 Καλωδίων / 2 Wire Adaptor
 Material Αλουμίνιο - Πλαστικό - Χαλκός / Aluminium - Plastic - Copper

5
 YEARS
 WARRANTY

| Code | Barcode | Weight (kg) | Color | Packing | MOQ |
|-----------|---------------|-------------|-------|---------|-----|
| 145-59009 | 5207227263781 | 0.005 | WHITE | 1/50 | 1 |
| 145-59029 | 5207227263859 | 0.005 | BLACK | 1/50 | 1 |





Σποτ LED Ράγας
4 γραμμών

Track Spot LED Lights
4 lines

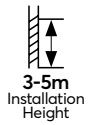
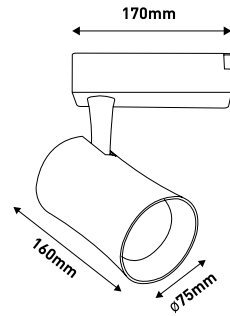

RNS
LED Driver



Ø75x160mm



LED Type SMD1919 • Chip Brand Epistar • Volt 220-240V 50/60Hz
Start Time 0.5 sec • PF >0.50 • Operating Temperature -20°C / +45°C
Connection Αντάπτορας 4 Καλωδίων / 4 Wire Adaptor
Material Αλουμίνιο - Πλαστικό - Χαλκός / Aluminium - Plastic - Copper



| Code | Barcode | Watt | Amperage mA | Kelvin | Lumen/Watt | Weight (kg) | Color | Packing | MOQ |
|-----------|---------------|------|-------------|--------|------------|-------------|-------|---------|-----|
| 145-59300 | 5207227263866 | 20 | 220 | 4000 | 85 | 0.590 | WHITE | 1/24 | 1 |
| 145-59301 | 5207227220357 | 20 | 220 | 4000 | 85 | 0.590 | BLACK | 1/24 | 1 |
| 145-59302 | 5207227158964 | 20 | 220 | 3000 | 85 | 0.590 | WHITE | 1/24 | 1 |
| 145-59303 | 5207227158995 | 20 | 220 | 3000 | 85 | 0.590 | BLACK | 1/24 | 1 |

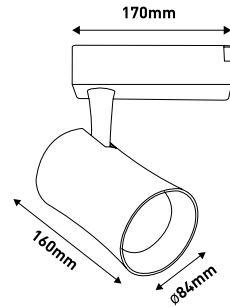

RNS
LED Driver



Ø84x160mm

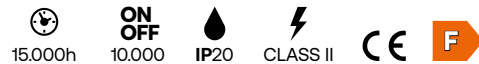

LED Type SMD1919 • Chip Brand Epistar • Volt 220-240V 50/60Hz
Start Time 0.5 sec • PF >0.50 • Operating Temperature -20°C / +45°C
Connection Αντάπτορας 4 Καλωδίων / 4 Wire Adaptor
Material Αλουμίνιο - Πλαστικό - Χαλκός / Aluminium - Plastic - Copper

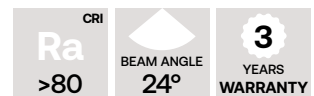

| Code | Barcode | Watt | Amperage mA | Kelvin | Lumen/Watt | Weight (kg) | Color | Packing | MOQ |
|-----------|---------------|------|-------------|--------|------------|-------------|-------|---------|-----|
| 145-59304 | 5207227263880 | 30 | 300 | 4000 | 85 | 0.675 | WHITE | 1/20 | 1 |
| 145-59305 | 5207227263897 | 30 | 300 | 4000 | 85 | 0.675 | BLACK | 1/20 | 1 |
| 145-59306 | 5207227159022 | 30 | 300 | 3000 | 85 | 0.675 | WHITE | 1/20 | 1 |
| 145-59307 | 5207227159046 | 30 | 300 | 3000 | 85 | 0.675 | BLACK | 1/20 | 1 |

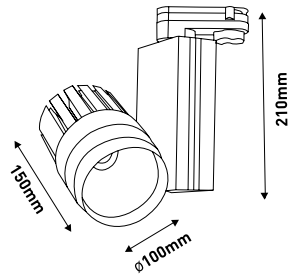

Dark Energy

LED Driver

Ø100x150x210mm



LED Type SMD1919 · Chip Brand Epistar · Volt 170-265V 50/60Hz
 Start Time 0.5 sec · PF >0.50 · Operating Temperature -20°C / +45°C
 Connection Αντάπτορας 4 Καλωδίων / 4 Wire Adaptor
 Material Αλουμίνιο - Πλαστικό - Χαλκός / Aluminium - Plastic - Copper

| | | |
|-------------------------|--------------------------|-------------------------------|
| CRI Ra >80 | BEAM ANGLE 24° | 3 YEARS WARRANTY |
|-------------------------|--------------------------|-------------------------------|

| Code | Barcode | Watt | Amperage mA | Kelvin | Lumen/Watt | Weight (kg) | Color | Packing | MOQ |
|-----------|---------------|------|-------------|--------|------------|-------------|-------|---------|-----|
| 145-59310 | 5207227233760 | 30 | 270 | 4000 | 85 | 0.675 | WHITE | 1/12 | 1 |
| 145-59311 | 5207227233777 | 30 | 270 | 4000 | 85 | 0.675 | BLACK | 1/12 | 1 |

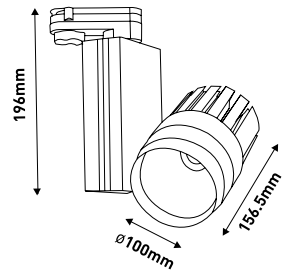

Manson

LED Driver

Ø100x156.5x196mm



LED Type SMD1919 · Chip Brand Hongli · Volt 100-265V 50/60Hz
 Start Time 0.5 sec · PF >0.90 · Operating Temperature -20°C / +45°C
 Connection Αντάπτορας 4 Καλωδίων / 4 Wire Adaptor
 Material Αλουμίνιο - Πλαστικό - Χαλκός / Aluminium - Plastic - Copper

| | | |
|-------------------------|--------------------------|-------------------------------|
| CRI Ra >80 | BEAM ANGLE 38° | 3 YEARS WARRANTY |
|-------------------------|--------------------------|-------------------------------|

| Code | Barcode | Watt | Amperage mA | Kelvin | Lumen/Watt | Weight (kg) | Color | Packing | MOQ |
|-----------|---------------|------|-------------|--------|------------|-------------|-------|---------|-----|
| 145-59315 | 5207227263934 | 30 | 700 | 4000 | 90 | 0.850 | WHITE | 1/10 | 1 |
| 145-59316 | 5207227233784 | 30 | 700 | 4000 | 90 | 0.850 | BLACK | 1/10 | 1 |



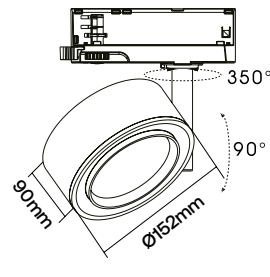

3CCT

(2700K 4300K 6000K)

DIMMING LED 30W

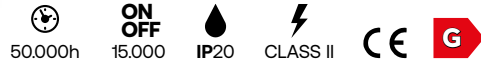

KGP
LED Driver



LED Type COB • Chip Brand TYF • Volt 220-240V 50/60Hz • Beam Angle 15° / 24° / 36° / 45° / 60°
Start Time 0.5 sec • PF >0.90 • Operating Temperature -20°C / +45°C
Connection Αντάπτορας 4 Καλωδίων / 4 Wire Adaptor
Material Αλουμίνιο - Πλαστικό - Χαλκός / Aluminium - Plastic - Copper



| Code | Barcode | Watt | Amperage mA | Kelvin | Lumen/Watt | Weight (kg) | Color | Packing | MOQ |
|-----------|---------------|------|-------------|--------|------------|-------------|-------|---------|-----|
| 145-59330 | 5207227298493 | 28 | 700 | 3CCT | 80 | 0.460 | WHITE | 1/30 | 1 |
| 145-59331 | 5207227298516 | 28 | 700 | 3CCT | 80 | 0.460 | BLACK | 1/30 | 1 |

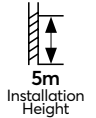
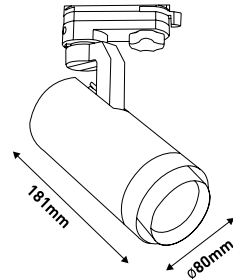

3CCT

(2700K 4300K 6000K)

Ø80x181mm

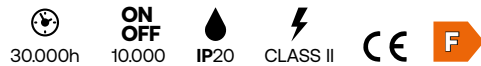

KGP
LED Driver



LED Type SMD1919 • Chip Brand Sunrise • Volt 220-240V 50/60Hz
Start Time 0.5 sec • PF >0.90 • Operating Temperature -20°C / +45°C
Connection Αντάπτορας 4 Καλωδίων / 4 Wire Adaptor
Material Αλουμίνιο - Πλαστικό - Χαλκός / Aluminium - Plastic - Copper

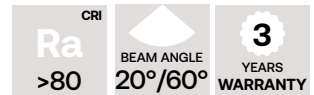

| Code | Barcode | Watt | Amperage mA | Kelvin | Lumen/Watt | Weight (kg) | Color | Packing | MOQ |
|-----------|---------------|------|-------------|--------|------------|-------------|-------|---------|-----|
| 145-59350 | 5207227263941 | 30 | 700 | 3CCT | 90 | 0.980 | WHITE | 1/8 | 1 |
| 145-59351 | 5207227240980 | 30 | 700 | 3CCT | 90 | 0.980 | BLACK | 1/15 | 1 |

MY-Q077-03



EAGLERISE
LED Driver

PLUS
SERIES

50.000h

ON
OFF
15.000

IP20

CLASS II

CE

F

LED Type SMD2835 • Chip Brand Osram • Volt 220-240V 50/60Hz
Start Time 0.5 sec • PF >0.50 • Operating Temperature -20°C / +45°C
Connection Αντάπτορας 4 Καλωδίων / 4 Wire Adaptor
Material Αλουμίνιο - Πλαστικό - Χαλκός / Aluminium - Plastic - Copper

LUMEN / WATT
lm/W
85

CRI
Ra
>80

BEAM ANGLE
120°

3
YEARS
WARRANTY

| Code | Barcode | Watt | Amperage mA | Kelvin | Dimension Ø (mm) † | Weight (kg) | Color | Packing | MOQ |
|-----------|---------------|------|----------------|--------|-----------------------|----------------|-------|---------|-----|
| 145-59408 | 5207227151071 | 18 | 450 | 4000 | 140 x 89 | 1.530 | WHITE | 1/20 | 1 |
| 145-59409 | 5207227151088 | 18 | 450 | 4000 | 140 x 89 | 1.530 | BLACK | 1/20 | 1 |
| 145-59410 | 5207227151095 | 18 | 450 | 3000 | 160 x 89 | 1.530 | WHITE | 1/20 | 1 |
| 145-59411 | 5207227151101 | 18 | 450 | 3000 | 160 x 89 | 1.530 | BLACK | 1/20 | 1 |



145-59314
Περσίδα Μεταλλική / Metallic Blind



Kegu
LED Driver

PRO
SERIES

25.000h

ON
OFF
15.000

IP20

CLASS II

CE

F

30W 4000K

LED Type SMD1919 • Chip Brand Epistar • Volt 220-240V 50/60Hz
Start Time 0.5 sec • PF >0.90 • Operating Temperature -20°C / +45°C
Connection Αντάπτορας 4 Καλωδίων / 4 Wire Adaptor
Material Αλουμίνιο - Πλαστικό - Χαλκός / Aluminium - Plastic - Copper

LUMEN / WATT
lm/W
90

CRI
Ra
>80

BEAM ANGLE
38°

3
YEARS
WARRANTY

| Code | Barcode | Watt | Amperage mA | Kelvin | Dimension Ø (mm) † | Weight (kg) | Color | Packing | MOQ |
|-----------|---------------|------|----------------|--------|-----------------------|----------------|-------|---------|-----|
| 145-59312 | 5207227263910 | 30 | 700 | 4000 | 90 x 260 | 0.810 | WHITE | 1/15 | 1 |
| 145-59313 | 5207227240973 | 30 | 700 | 4000 | 90 x 260 | 0.810 | BLACK | 1/15 | 1 |
| 145-59314 | 5207227263927 | - | - | - | - | 0.340 | BLACK | 1/30 | 1 |

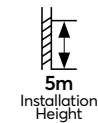
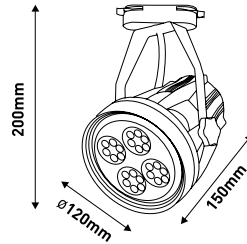

KGP
LED Driver

PLUS
SERIES

E27

IP20

CLASS II

CE

120x150mm

Volt 220-240V 50/60Hz
Operating Temperature -20°C / +45°C
Connection Αντάπτορας 4 Καλωδίων / 4 Wire Adaptor
Material Αλουμίνιο - Πλαστικό - Χαλκός / Aluminium - Plastic - Copper

3
YEARS
WARRANTY

| Code | Barcode | Watt | Weight (kg) | Color | Packing | MOQ |
|-----------|---------------|------------|----------------|-------|---------|-----|
| 145-59380 | 5207227263958 | MAX 15 LED | 0.650 | BLACK | 1/24 | 1 |
| 145-59381 | 5207227263965 | MAX 15 LED | 0.650 | WHITE | 1/24 | 1 |

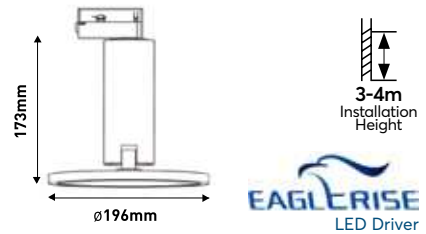

MY-079



LED Type SMD2835 • Chip Brand Osram • Volt 220-240V 50/60Hz
 Start Time 0.5 sec • PF >0.50 • Operating Temperature -20°C / +45°C
 Connection Αντάπτορας 4 Καλωδίων / 4 Wire Adaptor
 Material Αλουμίνιο - Πλαστικό - Χαλκός / Aluminium - Plastic - Copper

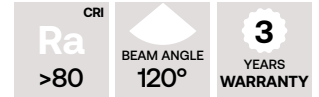

| Code | Barcode | Watt | Amperage mA | Kelvin | Lumen/Watt | Weight (kg) | Color | Packing | MOQ |
|-----------|---------------|------|-------------|--------|------------|-------------|-------|---------|-----|
| 145-59400 | 5207227150999 | 18 | 450 | 4000 | 85 | 1.350 | WHITE | 1/20 | 1 |
| 145-59401 | 5207227151002 | 18 | 450 | 4000 | 85 | 1.350 | BLACK | 1/20 | 1 |
| 145-59402 | 5207227151019 | 18 | 450 | 3000 | 85 | 1.350 | WHITE | 1/20 | 1 |
| 145-59403 | 5207227151026 | 18 | 450 | 3000 | 85 | 1.350 | BLACK | 1/20 | 1 |

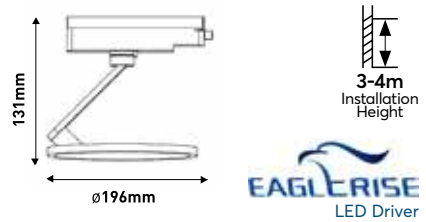

MY-080



LED Type SMD2835 • Chip Brand Osram • Volt 220-240V 50/60Hz
 Start Time 0.5 sec • PF >0.50 • Operating Temperature -20°C / +45°C
 Connection Αντάπτορας 4 Καλωδίων / 4 Wire Adaptor
 Material Αλουμίνιο - Πλαστικό - Χαλκός / Aluminium - Plastic - Copper

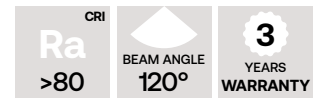

| Code | Barcode | Watt | Amperage mA | Kelvin | Lumen/Watt | Weight (kg) | Color | Packing | MOQ |
|-----------|---------------|------|-------------|--------|------------|-------------|-------|---------|-----|
| 145-59404 | 5207227151033 | 18 | 450 | 4000 | 85 | 1.600 | WHITE | 1/16 | 1 |
| 145-59405 | 5207227151040 | 18 | 450 | 4000 | 85 | 1.600 | BLACK | 1/16 | 1 |
| 145-59406 | 5207227151057 | 18 | 450 | 3000 | 85 | 1.600 | WHITE | 1/16 | 1 |
| 145-59407 | 5207227151064 | 18 | 450 | 3000 | 85 | 1.600 | BLACK | 1/16 | 1 |



3CCT

(2700K 4000K 5000K)

3CCT Selection

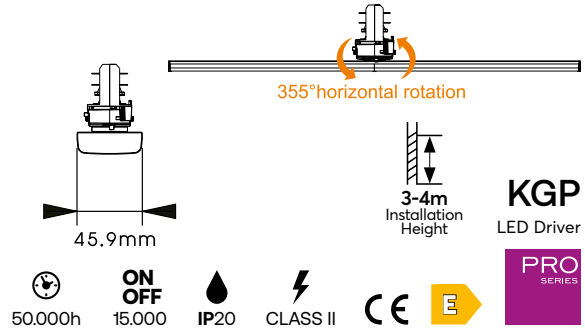

KGP
LED Driver



Γραμμικό Κινητό - Movable Linear Single

LED Type SMD2835 • Chip Brand Hongli • Volt 220-240V 50/60Hz
Start Time 0.5 sec • PF >0.90 • Operating Temperature -20°C / +45°C
Connection Αντάπτορας 4 Καλωδίων / 4 Wire Adaptor
Material Αλουμίνιο - Πλαστικό - Χαλκός / Aluminium - Plastic - Copper

| | | | |
|------------------------------------|-------------------------|---------------------------|----------------------------|
| LUMEN / WATT lm/W 100 | CRI Ra >90 | BEAM ANGLE 30°/60°/90° | 5 YEARS WARRANTY |
|------------------------------------|-------------------------|---------------------------|----------------------------|

| Code | Barcode | Dimension (mm) ↗ ↔ ↘ | Watt | Amperage mA | Kelvin | Weight (kg) | Color | Packing | MOQ |
|-----------|---------------|-------------------------|------|----------------|--------|----------------|-------|---------|-----|
| 145-59322 | 5207227474194 | 1144 x 61 x 84 | 40 | 1000 | 3CCT | 1.600 | WHITE | 1/12 | 1 |
| 145-59324 | 5207227474217 | 1144 x 61 x 84 | 40 | 1000 | 3CCT | 1.600 | BLACK | 1/12 | 1 |



3CCT

(2700K 4000K 5000K)

3CCT Selection

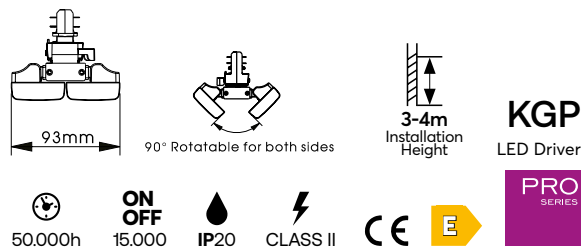

KGP
LED Driver



Γραμμικό Κινητό - Movable Linear Single

LED Type SMD2835 • Chip Brand Hongli • Volt 220-240V 50/60Hz
Start Time 0.5 sec • PF >0.90 • Operating Temperature -20°C / +45°C
Connection Αντάπτορας 4 Καλωδίων / 4 Wire Adaptor
Material Αλουμίνιο - Πλαστικό - Χαλκός / Aluminium - Plastic - Copper

| | | | |
|------------------------------------|-------------------------|---------------------------|----------------------------|
| LUMEN / WATT lm/W 100 | CRI Ra >90 | BEAM ANGLE 30°/60°/90° | 5 YEARS WARRANTY |
|------------------------------------|-------------------------|---------------------------|----------------------------|

| Code | Barcode | Dimension (mm) ↗ ↔ ↘ | Watt | Amperage mA | Kelvin | Weight (kg) | Color | Packing | MOQ |
|-----------|---------------|-------------------------|------|----------------|--------|----------------|-------|---------|-----|
| 145-59326 | 5207227474231 | 1144 x 123 x 71 x | 40 | 1000 | 3CCT | 2.400 | WHITE | 1/6 | 1 |
| 145-59328 | 5207227474255 | 1144 x 123 x 71 x | 40 | 1000 | 3CCT | 2.400 | BLACK | 1/6 | 1 |



Stop 535x33x58mm

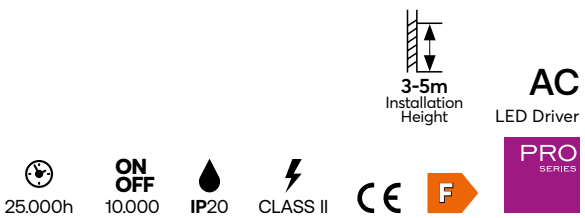

AC
LED Driver



LED Type SMD2835 • Chip Brand Epistar • Volt 220-240V 50/60Hz
Start Time 0.5 sec • PF >0.50 • Operating Temperature -20°C / +45°C
Connection Αντάπτορας 4 Καλωδίων / 4 Wire Adaptor
Material Αλουμίνιο - Πλαστικό - Χαλκός / Aluminium - Plastic - Copper

| | | |
|-------------------------|-------------------|----------------------------|
| CRI Ra >80 | BEAM ANGLE 24° | 3 YEARS WARRANTY |
|-------------------------|-------------------|----------------------------|

| Code | Barcode | Watt | Amperage mA | Kelvin | Lumen/Watt | Weight (kg) | Color | Packing | MOQ |
|-----------|---------------|------|----------------|--------|------------|----------------|-------------|---------|-----|
| 145-55090 | 5207227061622 | 15 | 60 | 4000 | 90 | 0.433 | WHITE/BLACK | 1/20 | 1 |



Πάγα Universal 4 Γραμμών - Universal Track 4 lines



Volt 220-240V 50/60Hz

Operating Temperature -20°C / +45°C

Connection Αντάπτορας 4 Καλωδίων / 4 Wire Adaptor

Material Αλουμίνιο - Πλαστικό - Χαλκός / Aluminium - Plastic - Copper



| Code | Barcode | Dimension (mm) | | | Weight (kg) | Color | Packing | MOQ |
|-----------|---------------|----------------|----|----|-------------|-------|---------|-----|
| | | ↗ | ↔ | ↓ | | | | |
| 145-59100 | 5207227473142 | 1000 | 32 | 36 | 0.800 | WHITE | 1\10 | 1 |
| 145-59101 | 5207227446740 | 2000 | 32 | 36 | 1.600 | WHITE | 1\10 | 1 |
| 145-59102 | 5207227446757 | 3000 | 32 | 36 | 2.400 | WHITE | 1\10 | 1 |
| 145-59130 | 5207227473425 | 1000 | 32 | 36 | 0.800 | BLACK | 1\10 | 1 |
| 145-59131 | 5207227446825 | 2000 | 32 | 36 | 1.600 | BLACK | 1\10 | 1 |
| 145-59132 | 5207227473432 | 3000 | 32 | 36 | 2.400 | BLACK | 1\10 | 1 |

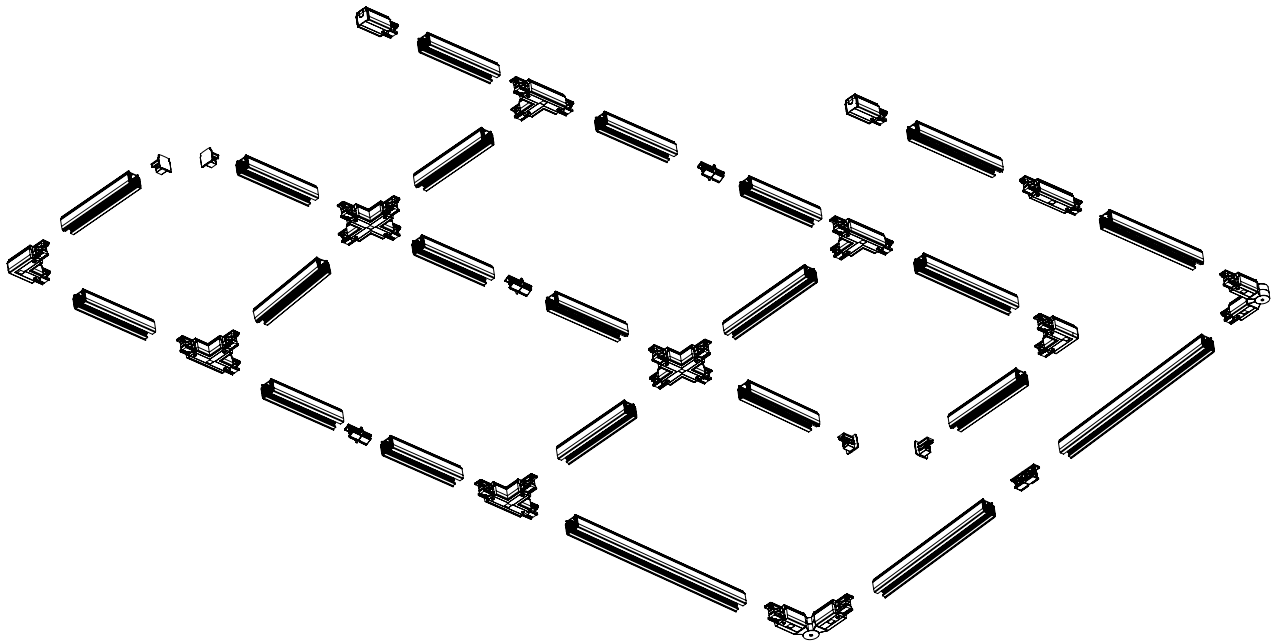



Τροφοδοσία Αριστερή - Power Left 66x32x32mm



Volt 220-240V 50/60Hz
 Operating Temperature -20°C / +45°C
 Connection Αντάπτορας 4 Καλωδίων / 4 Wire Adaptor
 Material Αλουμίνιο - Πλαστικό - Χαλκός / Aluminium - Plastic - Copper



| Code | Barcode | Weight (kg) | Color | Packing | MOQ |
|-----------|---------------|-------------|-------|---------|-----|
| 145-59103 | 5207227473166 | 0.058 | WHITE | 1\50 | 1 |
| 145-59133 | 5207227473456 | 0.058 | BLACK | 1\50 | 1 |



Τροφοδοσία Δεξιά - Power Right 66x32x32mm



Volt 220-240V 50/60Hz
 Operating Temperature -20°C / +45°C
 Connection Αντάπτορας 4 Καλωδίων / 4 Wire Adaptor
 Material Αλουμίνιο - Πλαστικό - Χαλκός / Aluminium - Plastic - Copper



| Code | Barcode | Weight (kg) | Color | Packing | MOQ |
|-----------|---------------|-------------|-------|---------|-----|
| 145-59104 | 5207227473173 | 0.058 | WHITE | 1\50 | 1 |
| 145-59134 | 5207227473463 | 0.058 | BLACK | 1\50 | 1 |



Σύνδεσμος - Conjunction 68x20x27mm



Volt 220-240V 50/60Hz
 Operating Temperature -20°C / +45°C
 Connection Αντάπτορας 4 Καλωδίων / 4 Wire Adaptor
 Material Αλουμίνιο - Πλαστικό - Χαλκός / Aluminium - Plastic - Copper



| Code | Barcode | Weight (kg) | Color | Packing | MOQ |
|-----------|---------------|-------------|-------|---------|-----|
| 145-59105 | 5207227473180 | 0.027 | WHITE | 1\100 | 1 |
| 145-59135 | 5207227446832 | 0.027 | BLACK | 1\100 | 1 |



Σύνδεσμος με Τροφοδοσία - Conjunction with Power 100x32x32mm

IP20 CE

Volt 220-240V 50/60Hz

Operating Temperature -20°C / +45°C

Connection Αντάπτορας 4 Καλωδίων / 4 Wire Adaptor

Material Αλουμίνιο - Πλαστικό - Χαλκός / Aluminium - Plastic - Copper

5
YEARS
WARRANTY

| Code | Barcode | Weight (kg) | Color | Packing | MOQ |
|-----------|---------------|-------------|-------|---------|-----|
| 145-59106 | 5207227473197 | 0.108 | WHITE | 1\50 | 1 |
| 145-59136 | 5207227473470 | 0.108 | BLACK | 1\50 | 1 |



Μεταβλητός Σύνδεσμος "L"- Variable Conjunction Type "L" 175x32x32mm

IP20 CE

Volt 220-240V 50/60Hz

Operating Temperature -20°C / +45°C

Connection Αντάπτορας 4 Καλωδίων / 4 Wire Adaptor

Material Αλουμίνιο - Πλαστικό - Χαλκός / Aluminium - Plastic - Copper

5
YEARS
WARRANTY

| Code | Barcode | Weight (kg) | Color | Packing | MOQ |
|-----------|---------------|-------------|-------|---------|-----|
| 145-59107 | 5207227446764 | 0.150 | WHITE | 1\25 | 1 |
| 145-59137 | 5207227473487 | 0.150 | BLACK | 1\25 | 1 |



Σύνδεσμος Γωνία Σπирάλ - Conjunction Spiral Corner 90° 100x100x32mm

IP20 CE

Volt 220-240V 50/60Hz

Operating Temperature -20°C / +45°C

Connection Αντάπτορας 4 Καλωδίων / 4 Wire Adaptor

Material Αλουμίνιο - Πλαστικό - Χαλκός / Aluminium - Plastic - Copper

5
YEARS
WARRANTY

| Code | Barcode | Weight (kg) | Color | Packing | MOQ |
|-----------|---------------|-------------|-------|---------|-----|
| 145-59108 | 5207227473203 | 0.240 | WHITE | 1\10 | 1 |
| 145-59138 | 5207227473494 | 0.240 | BLACK | 1\10 | 1 |



Σύνδεσμος Σταυρός - Conjunction Cross 100x66x32mm



Volt 220-240V 50/60Hz
 Operating Temperature -20°C / +45°C
 Connection Αντάπτορας 4 Καλωδίων / 4 Wire Adaptor
 Material Αλουμίνιο - Πλαστικό - Χαλκός / Aluminium - Plastic - Copper



| Code | Barcode | Weight (kg) | Color | Packing | MOQ |
|-----------|---------------|-------------|-------|---------|-----|
| 145-59109 | 5207227473210 | 0.160 | WHITE | 1\25 | 1 |
| 145-59139 | 5207227473500 | 0.160 | BLACK | 1\25 | 1 |



Σύνδεσμος Αριστερή/1 - Conjunction Left/1 100x66x32mm



Volt 220-240V 50/60Hz
 Operating Temperature -20°C / +45°C
 Connection Αντάπτορας 4 Καλωδίων / 4 Wire Adaptor
 Material Αλουμίνιο - Πλαστικό - Χαλκός / Aluminium - Plastic - Copper



| Code | Barcode | Weight (kg) | Color | Packing | MOQ |
|-----------|---------------|-------------|-------|---------|-----|
| 145-59110 | 5207227446771 | 0.160 | WHITE | 1\25 | 1 |
| 145-59140 | 5207227473517 | 0.160 | BLACK | 1\25 | 1 |



Σύνδεσμος Αριστερή/2 - Conjunction Left/2 100x66x32mm



Volt 220-240V 50/60Hz
 Operating Temperature -20°C / +45°C
 Connection Αντάπτορας 4 Καλωδίων / 4 Wire Adaptor
 Material Αλουμίνιο - Πλαστικό - Χαλκός / Aluminium - Plastic - Copper



| Code | Barcode | Weight (kg) | Color | Packing | MOQ |
|-----------|---------------|-------------|-------|---------|-----|
| 145-59111 | 5207227473234 | 0.160 | WHITE | 1\25 | 1 |
| 145-59141 | 5207227473531 | 0.160 | BLACK | 1\25 | 1 |



Σύνδεσμος Δεξιά/1 - Conjunction Right/1 100x66x32mm



Volt 220-240V 50/60Hz
 Operating Temperature -20°C / +45°C
 Connection Αντάπτορας 4 Καλωδίων / 4 Wire Adaptor
 Material Αλουμίνιο - Πλαστικό - Χαλκός / Aluminium - Plastic - Copper



| Code | Barcode | Weight (kg) | Color | Packing | MOQ |
|-----------|---------------|-------------|-------|---------|-----|
| 145-59112 | 5207227473258 | 0.160 | WHITE | 1\25 | 1 |
| 145-59142 | 5207227473555 | 0.160 | BLACK | 1\25 | 1 |



Σύνδεσμος Δεξιά/2 - Conjunction Right/2 66x66x32mm



Volt 220-240V 50/60Hz
 Operating Temperature -20°C / +45°C
 Connection Αντάπτορας 4 Καλωδίων / 4 Wire Adaptor
 Material Αλουμίνιο - Πλαστικό - Χαλκός / Aluminium - Plastic - Copper



| Code | Barcode | Weight (kg) | Color | Packing | MOQ |
|-----------|---------------|-------------|-------|---------|-----|
| 145-59113 | 5207227473272 | 0.112 | WHITE | 1\25 | 1 |
| 145-59143 | 5207227473579 | 0.112 | BLACK | 1\25 | 1 |



Σύνδεσμος Γωνία Εξωτερική - Conjunction Surface Corner 90° 66x66x32mm



Volt 220-240V 50/60Hz
 Operating Temperature -20°C / +45°C
 Connection Αντάπτορας 4 Καλωδίων / 4 Wire Adaptor
 Material Αλουμίνιο - Πλαστικό - Χαλκός / Aluminium - Plastic - Copper



| Code | Barcode | Weight (kg) | Color | Packing | MOQ |
|-----------|---------------|-------------|-------|---------|-----|
| 145-59114 | 5207227446788 | 0.112 | WHITE | 1\25 | 1 |
| 145-59144 | 5207227446849 | 0.112 | BLACK | 1\25 | 1 |



Σύνδεσμος Γωνία Εξωτερική - Conjunction Surface Corner 90° 66x66x32mm



Volt 220-240V 50/60Hz
 Operating Temperature -20°C / +45°C
 Connection Αντάπτορας 4 Καλωδίων / 4 Wire Adaptor
 Material Αλουμίνιο - Πλαστικό - Χαλκός / Aluminium - Plastic - Copper



| Code | Barcode | Weight (kg) | Color | Packing | MOQ |
|-----------|---------------|-------------|-------|---------|-----|
| 145-59115 | 5207227446795 | 0.052 | WHITE | 1\100 | 1 |
| 145-59145 | 5207227473135 | 0.052 | BLACK | 1\100 | 1 |



Αντάπτορας με Καλώδιο - Adapter with Cable 96x49



Volt 220-240V 50/60Hz
 Operating Temperature -20°C / +45°C
 Connection Αντάπτορας 4 Καλωδίων / 4 Wire Adaptor
 Material Αλουμίνιο - Πλαστικό - Χαλκός / Aluminium - Plastic - Copper



| Code | Barcode | Weight (kg) | Color | Packing | MOQ |
|-----------|---------------|-------------|-------|---------|-----|
| 145-59116 | 5207227473289 | 0.058 | WHITE | 1\100 | 1 |
| 145-59146 | 5207227473111 | 0.058 | BLACK | 1\100 | 1 |



Αντάπτορας - Adapter 96x49



Volt 220-240V 50/60Hz
 Operating Temperature -20°C / +45°C
 Connection Αντάπτορας 4 Καλωδίων / 4 Wire Adaptor
 Material Αλουμίνιο - Πλαστικό - Χαλκός / Aluminium - Plastic - Copper



| Code | Barcode | Weight (kg) | Color | Packing | MOQ |
|-----------|---------------|-------------|-------|---------|-----|
| 145-59117 | 5207227446795 | 0.077 | WHITE | 1\100 | 1 |
| 145-59147 | 5207227473135 | 0.077 | BLACK | 1\100 | 1 |



Ροζέτα - Rosette 180x32x32mm

IP20

Operating Temperature -20°C / +45°C
Material Πλαστικό - Μεταλλικό / Plastic - Metal

5
YEARS
WARRANTY

| Code | Barcode | Weight (kg) | Color | Packing | MOQ |
|-----------|---------------|-------------|-------|---------|-----|
| 145-59119 | 5207227473326 | 0.094 | WHITE | 1\100 | 1 |
| 145-59149 | 5207227473081 | 0.094 | BLACK | 1\100 | 1 |



Βάση - Base 1,8cm 2000x32x40mm

IP20

Operating Temperature -20°C / +45°C
Material Πλαστικό - Μεταλλικό / Plastic - Metal

5
YEARS
WARRANTY

| Code | Barcode | Weight (kg) | Color | Packing | MOQ |
|-----------|---------------|-------------|-------|---------|-----|
| 145-59120 | 5207227473340 | 0.047 | WHITE | 1\100 | 1 |
| 145-59150 | 5207227473067 | 0.047 | BLACK | 1\100 | 1 |



Βάση - Base 2,5cm 2000x32x12mm

IP20

Operating Temperature -20°C / +45°C
Material Πλαστικό - Μεταλλικό / Plastic - Metal

5
YEARS
WARRANTY

| Code | Barcode | Weight (kg) | Color | Packing | MOQ |
|-----------|---------------|-------------|-------|---------|-----|
| 145-59121 | 5207227473364 | 0.057 | WHITE | 1\100 | 1 |
| 145-59151 | 5207227473043 | 0.057 | BLACK | 1\100 | 1 |



Βάση - Base 3cm 25x32x40mm

IP20

Operating Temperature -20°C / +45°C
Material Πλαστικό - Μεταλλικό / Plastic - Metal

5
YEARS
WARRANTY

| Code | Barcode | Weight (kg) | Color | Packing | MOQ |
|-----------|---------------|-------------|-------|---------|-----|
| 145-59122 | 5207227473388 | 0.016 | WHITE | 1\500 | 1 |
| 145-59152 | 5207227473029 | 0.016 | BLACK | 1\500 | 1 |



Βάση Κουμπωτή - Base Button 30x32x12mm

IP20

Operating Temperature -20°C / +45°C
Material Πλαστικό - Μεταλλικό / Plastic - Metal

5
YEARS
WARRANTY

| Code | Barcode | Weight (kg) | Color | Packing | MOQ |
|-----------|---------------|-------------|-------|---------|-----|
| 145-59123 | 5207227473401 | 0.012 | WHITE | 1\500 | 1 |
| 145-59153 | 5207227474163 | 0.012 | BLACK | 1\500 | 1 |



Ντίζα με Ροζέτα Στήριξης - Cable with Support Rossette 60x24x10mm

IP20

Operating Temperature -20°C / +45°C
Material Πλαστικό - Μεταλλικό / Plastic - Metal

5
YEARS
WARRANTY

| Code | Barcode | Weight (kg) | Color | Packing | MOQ |
|-----------|---------------|-------------|-------|---------|-----|
| 145-59124 | 5207227446801 | 0.009 | WHITE | 1\500 | 1 |
| 145-59154 | 5207227446856 | 0.009 | BLACK | 1\500 | 1 |



Ντίζα με Βάση Οροφής - Rod With Ceiling Mount

IP20

5
YEARS
WARRANTY

Operating Temperature -20°C / +45°C
Material Πλαστικό - Μεταλλικό / Plastic - Metal

| Code | Barcode | Weight (kg) | Color | Packing | MOQ |
|-----------|---------------|-------------|-------|---------|-----|
| 145-59125 | 5207227446818 | 0.008 | WHITE | 1\200 | 1 |
| 145-59155 | 5207227446863 | 0.008 | BLACK | 1\200 | 1 |



Ντίζα Ροζέτα με Τροφοδοσία - Cable Rossette with Power

IP20

5
YEARS
WARRANTY

Material Πλαστικό - Μεταλλικό / Plastic - Metal

| Code | Barcode | Weight (kg) | Color | Packing | MOQ |
|-----------|---------------|-------------|-------|---------|-----|
| 145-59127 | 5207227475061 | - | WHITE | - | 1 |
| 145-59157 | 5207227475078 | - | BLACK | - | 1 |



Τερματικό - Terminal

IP20

5
YEARS
WARRANTY

Material Πλαστικό / Plastic

| Code | Barcode | Weight (kg) | Color | Packing | MOQ |
|-----------|---------------|-------------|-------|---------|-----|
| 145-59126 | 5207227473418 | 0.047 | WHITE | - | 1 |
| 145-59156 | 5207227474170 | 0.047 | BLACK | - | 1 |

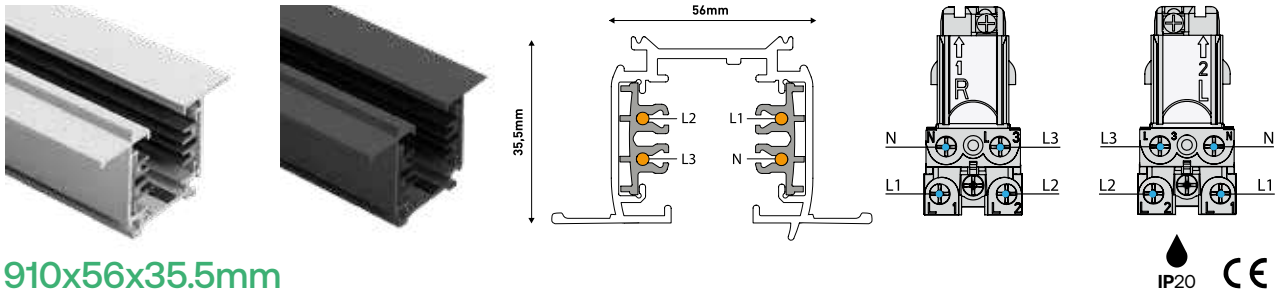

910x56x35.5mm

IP20 CE

Volt 100-265V 50/60Hz
 Operating Temperature -20°C / +45°C
 Connection Αντάπτορας 4 Καλωδίων / 4 Wire Adaptor
 Material Αλουμίνιο - Πλαστικό - Χαλκός / Aluminium - Plastic - Copper

2
YEARS
WARRANTY

| Code | Barcode | Weight (kg) | Color | Packing | MOQ |
|-----------|---------------|-------------|-------|---------|-----|
| 145-59240 | 5207227151330 | 0.900 | WHITE | 1/50 | 1 |
| 145-59250 | 5207227151422 | 0.900 | BLACK | 1/50 | 1 |
| 145-59241 | 5207227151347 | 1,850 | WHITE | 1/50 | 1 |
| 145-59251 | 5207227151439 | 1,850 | BLACK | 1/50 | 1 |



Τροφοδοσία - with Power

IP20 CE

Volt 100-265V 50/60Hz
 Operating Temperature -20°C / +45°C
 Connection Αντάπτορας 4 Καλωδίων / 4 Wire Adaptor
 Material Αλουμίνιο - Πλαστικό - Χαλκός / Aluminium - Plastic - Copper

2
YEARS
WARRANTY

| Code | Barcode | Weight (kg) | Color | Packing | MOQ |
|-----------|---------------|-------------|-------|---------|-----|
| 145-59242 | 5207227151354 | 0.050 | WHITE | 1/50 | 1 |
| 145-59252 | 5207227151446 | 0.050 | BLACK | 1/50 | 1 |



Σύνδεσμος - Conjunction

IP20 CE

Volt 100-265V 50/60Hz
 Operating Temperature -20°C / +45°C
 Connection Αντάπτορας 4 Καλωδίων / 4 Wire Adaptor
 Material Αλουμίνιο - Πλαστικό - Χαλκός / Aluminium - Plastic - Copper

2
YEARS
WARRANTY

| Code | Barcode | Weight (kg) | Color | Packing | MOQ |
|-----------|---------------|-------------|-------|---------|-----|
| 145-59243 | 5207227151361 | 0.023 | WHITE | 1/500 | 1 |
| 145-59253 | 5207227151453 | 0.023 | BLACK | 1/500 | 1 |

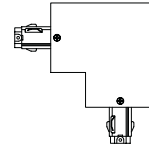

Σύνδεσμος Γωνία - Conjunction Corner 90°



Volt 100-265V 50/60Hz
 Operating Temperature -20°C / +45°C
 Connection Αντάπτορας 4 Καλωδίων / 4 Wire Adaptor
 Material Αλουμίνιο - Πλαστικό - Χαλκός / Aluminium - Plastic - Copper



| Code | Barcode | Weight (kg) | Color | Packing | MOQ |
|-----------|---------------|-------------|-------|---------|-----|
| 145-59245 | 5207227151378 | 0.105 | WHITE | 1/50 | 1 |
| 145-59255 | 5207227151460 | 0.105 | BLACK | 1/50 | 1 |

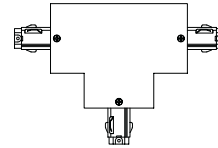
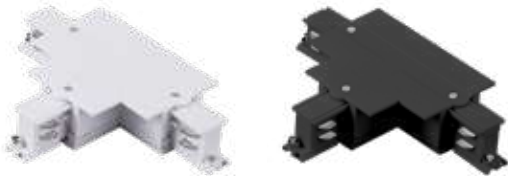

Σύνδεσμος Ταφ - Conjunction type "T"



Volt 100-265V 50/60Hz
 Operating Temperature -20°C / +45°C
 Connection Αντάπτορας 4 Καλωδίων / 4 Wire Adaptor
 Material Αλουμίνιο - Πλαστικό - Χαλκός / Aluminium - Plastic - Copper



| Code | Barcode | Weight (kg) | Color | Packing | MOQ |
|-----------|---------------|-------------|-------|---------|-----|
| 145-59246 | 5207227151385 | 0.151 | WHITE | 1/25 | 1 |
| 145-59256 | 5207227151477 | 0.151 | BLACK | 1/25 | 1 |

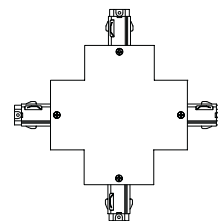

Σύνδεσμος Σταυρός - Conjunction Cross



Volt 100-265V 50/60Hz
 Operating Temperature -20°C / +45°C
 Connection Αντάπτορας 4 Καλωδίων / 4 Wire Adaptor
 Material Αλουμίνιο - Πλαστικό - Χαλκός / Aluminium - Plastic - Copper



| Code | Barcode | Weight (kg) | Color | Packing | MOQ |
|-----------|---------------|-------------|-------|---------|-----|
| 145-59247 | 5207227151392 | 0.200 | WHITE | 1/25 | 1 |
| 145-59257 | 5207227151484 | 0.200 | BLACK | 1/25 | 1 |

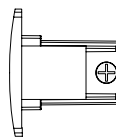

Τερματικό - Terminal

IP20

Operating Temperature -20°C / +45°C
Material Πλαστικό / Plastic

2
YEARS
WARRANTY

| Code | Barcode | Weight (kg) | Color | Packing | MOQ |
|-----------|---------------|-------------|-------|---------|-----|
| 145-59248 | 5207227151408 | 0.007 | WHITE | 1/500 | 1 |
| 145-59258 | 5207227151491 | 0.007 | BLACK | 1/500 | 1 |



Εξάρτημα Στήριξης - Support Part

IP20 CE

Volt 100-265V 50/60Hz
Operating Temperature -20°C / +45°C
Connection Αντάπτορας 4 Καλωδίων / 4 Wire Adaptor
Material Μεταλλικό / Metallic

2
YEARS
WARRANTY

| Code | Barcode | Weight (kg) | Color | Packing | MOQ |
|-----------|---------------|-------------|-------|---------|-----|
| 145-59249 | 5207227151415 | 0.009 | METAL | 1/500 | 1 |

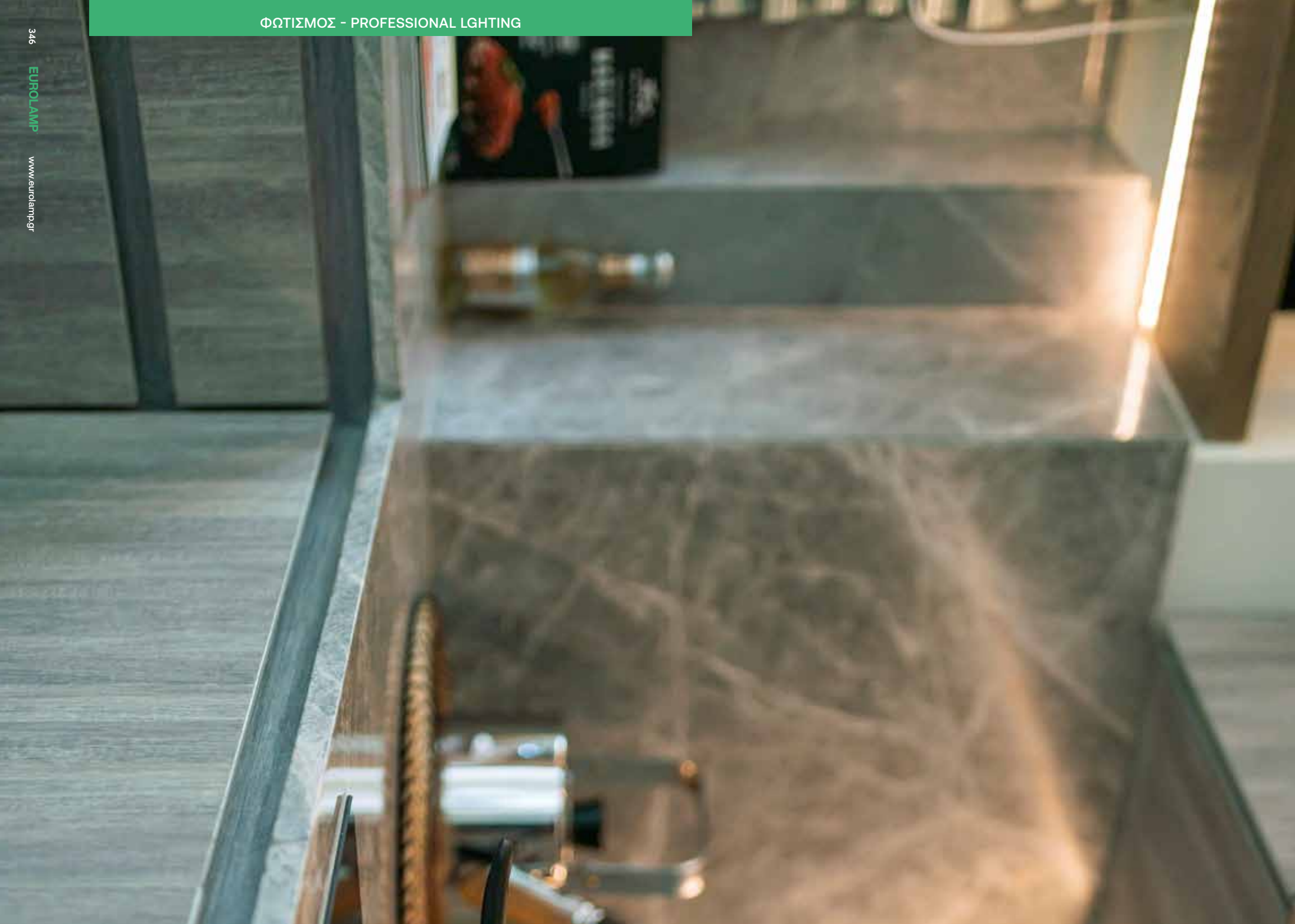



Φωτιστικά Πάγκου
& Εσωτερικού Χώρου

Countertop
& Indoor Lights

ΦΩΤΙΣΜΟΣ - PROFESSIONAL LIGHTING



Sanan
LED Driver

PLUS
SERIES

Φωτιστικά Κλειστού Τύπου με Ταινίες LED
Closed Type Lights with LED Tapes



LED Type SMD2835 • Chip Brand Sanan • Volt 200-240V 50/60Hz
Start Time 1.0 sec • PF >0.50 • Operating Temperature -20°C / +40°C
Connection Καλώδιο / Wire • Material Πλαστικό / Plastic

| | | | |
|-----------------------------|------------------|--------------------|------------------------|
| LUMEN / WATT lm/W 120 | CRI Ra >80 | BEAM ANGLE 120° | 3 YEARS WARRANTY |
|-----------------------------|------------------|--------------------|------------------------|

| Code | Barcode | Dimension (mm) ↕ ↔ ↕ | Watt | Amperage mA | Kelvin | Total Lumen | Weight (kg) | Packing | MOQ |
|-----------|---------------|-------------------------|----------|----------------|--------|-------------|----------------|---------|-----|
| 147-55340 | 5207227409325 | 300 x 75 x 23 | 3/6/9 | 50 | 3CCT | 1080 | 0.120 | 1/30 | 1 |
| 147-55341 | 5207227409349 | 600 x 75 x 23 | 10/15/20 | 106 | 3CCT | 2400 | 0.187 | 1/30 | 1 |
| 147-55342 | 5207227409363 | 900 x 75 x 23 | 15/20/24 | 132 | 3CCT | 2880 | 0.246 | 1/30 | 1 |
| 147-55343 | 5207227409387 | 1200 x 75 x 23 | 25/32/40 | 178 | 3CCT | 4800 | 0.310 | 1/30 | 1 |
| 147-55344 | 5207227409400 | 1500 x 75 x 23 | 30/40/50 | 225 | 3CCT | 6000 | 0.400 | 1/25 | 1 |



3 CCT
(3000K 4000K 6500K)



EPS
LED Driver

PLUS
SERIES

Φωτιστικά Πάγκου LED 3CCT Πλαστικά
Lighting LED Tube Fixtures 3CCT Plastic



LED Type SMD2835 • Chip Brand Sanan • Volt 175-265V 50/60Hz
Start Time 0.5 sec • PF >0.70 • Operating Temperature -10°C / +40°C
Connection 0,5m Καλώδιο με Φικς / 0,5m Wire with Plug
Material Πλαστικό / Plastic

| | | | |
|-----------------------------|------------------|--------------------|------------------------|
| LUMEN / WATT lm/W 120 | CRI Ra >80 | BEAM ANGLE 140° | 2 YEARS WARRANTY |
|-----------------------------|------------------|--------------------|------------------------|

| Code | Barcode | Dimension (mm) ↕ ↔ ↕ | Watt | Amperage mA | Kelvin | Total Lumen | Weight (kg) | Packing | MOQ |
|-----------|---------------|-------------------------|------|----------------|--------|-------------|----------------|---------|-----|
| 147-55330 | 5207227427640 | 304 x 22 x 36 | 4 | 33 | 3CCT | 480 | 0.100 | 1/30 | 1 |
| 147-55331 | 5207227427664 | 574 x 22 x 36 | 8 | 67 | 3CCT | 960 | 0.150 | 1/30 | 1 |
| 147-55332 | 5207227427688 | 874 x 22 x 36 | 12 | 100 | 3CCT | 1440 | 0.220 | 1/30 | 1 |
| 147-55333 | 5207227427701 | 1174 x 22 x 36 | 16 | 133 | 3CCT | 1920 | 0.250 | 1/30 | 1 |
| 147-55334 | 5207227427725 | 1474 x 22 x 36 | 20 | 167 | 3CCT | 2400 | 0.320 | 1/30 | 1 |



Φωτιστικά Πάγκου LED Πλαστικά
Lighting LED Tube Fixtures Plastic



LED Type SMD2835 • Chip Brand Sanan • Volt 175-265V 50/60Hz
Start Time 0.5 sec • PF >0.70 • Operating Temperature -20°C / +40°C
Connection 0,5m Καλώδιο με Φις / 0,5m Wire with Plug
Material Πλαστικό / Plastic

| | | | |
|-----------------------------|------------------|--------------------|------------------------|
| LUMEN / WATT lm/W 100 | CRI Ra >80 | BEAM ANGLE 160° | 2 YEARS WARRANTY |
|-----------------------------|------------------|--------------------|------------------------|

| Code | Barcode | Dimension (mm) ↕ ↔ ↕ | Watt | Amperage mA | Kelvin | Total Lumen | Weight (kg) | Packing | MOQ |
|-----------|---------------|-------------------------|------|----------------|--------|-------------|----------------|---------|-----|
| 147-55300 | 5207227122743 | 304 x 22 x 36 | 4 | 50 | 6500 | 400 | 0.050 | 1/30 | 1 |
| 147-55301 | 5207227111273 | 304 x 22 x 36 | 4 | 50 | 4000 | 400 | 0.050 | 1/30 | 1 |
| 147-55303 | 5207227111297 | 574 x 22 x 36 | 8 | 75 | 6500 | 800 | 0.075 | 1/30 | 1 |
| 147-55304 | 5207227111310 | 574 x 22 x 36 | 8 | 75 | 4000 | 800 | 0.075 | 1/30 | 1 |
| 147-55306 | 5207227111334 | 874 x 22 x 36 | 12 | 85 | 6500 | 1200 | 0.130 | 1/30 | 1 |
| 147-55307 | 5207227111358 | 874 x 22 x 36 | 12 | 85 | 4000 | 1200 | 0.130 | 1/30 | 1 |
| 147-55309 | 5207227111372 | 1184 x 22 x 36 | 16 | 105 | 6500 | 1600 | 0.270 | 1/30 | 1 |
| 147-55310 | 5207227111396 | 1184 x 22 x 36 | 16 | 105 | 4000 | 1600 | 0.270 | 1/30 | 1 |
| 147-55312 | 5207227111419 | 1474 x 22 x 36 | 20 | 120 | 6500 | 2000 | 0.380 | 1/30 | 1 |
| 147-55313 | 5207227111433 | 1474 x 22 x 36 | 20 | 120 | 4000 | 2000 | 0.380 | 1/30 | 1 |





Φωτιστικά Μεταλλικά Κενά με Ρεύμα 1 Ακρων
Lighting Metal Blanks with 1-Prong Current



Volt 80-270V 50/60Hz • PF T8 • Operating Temperature -20°C / +50°C
Connection Καλώδιο / Wire • Material Σίδηρος / Iron

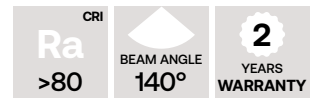

| Code | Barcode | Dimension (mm) ↗ ↔ ↘ | Watt | Weight (kg) | Packing | MOQ |
|-----------|---------------|-------------------------|---------------|-------------|---------|-----|
| 147-56550 | 5207227018725 | 610 x 34 x 15 | MAX 1X9W LED | 0.115 | 1/50 | 10 |
| 147-56551 | 5207227018749 | 1200 x 34 x 15 | MAX 1X18W LED | 0.170 | 1/25 | 10 |
| 147-56556 | 5207227031595 | 1500 x 34 x 15 | MAX 1X24W LED | 0.230 | 1/25 | 10 |
| 147-56553 | 5207227018763 | 610 x 34 x 15 | MAX 2X9W LED | 0.135 | 1/25 | 10 |
| 147-56554 | 5207227018787 | 1200 x 34 x 15 | MAX 2X18W LED | 0.190 | 1/25 | 10 |
| 147-56557 | 5207227031625 | 1500 x 34 x 15 | MAX 2X24W LED | 0.250 | 1/25 | 10 |

Φωτιστικά Μεταλλικά Κενά με Ρεύμα 2 Ακρων
Lighting Metal Blanks with 2-Prong Current

| Code | Barcode | Dimension (mm) ↗ ↔ ↘ | Watt | Weight (kg) | Packing | MOQ |
|-----------|---------------|-------------------------|---------------|-------------|---------|-----|
| 147-56560 | 5207227288777 | 610 x 34 x 15 | MAX 1X10W LED | 0.115 | 1/25 | 10 |
| 147-56561 | 5207227288791 | 1200 x 34 x 15 | MAX 1X18W LED | 0.170 | 1/25 | 10 |
| 147-56562 | 5207227288814 | 1500 x 34 x 15 | MAX 1X24W LED | 0.230 | 1/25 | 10 |
| 147-56563 | 5207227288838 | 610 x 34 x 15 | MAX 2X10W LED | 0.135 | 1/25 | 10 |
| 147-56564 | 5207227288852 | 1200 x 34 x 15 | MAX 2X18W LED | 0.190 | 1/25 | 10 |
| 147-56565 | 5207227288876 | 1500 x 34 x 15 | MAX 2X24W LED | 0.250 | 1/25 | 10 |





Φωτιστικά Μεταλλικά Κενά Οβάλ
Lighting Metal Blanks Oval



Volt 80-270V 50/60Hz · PF T8 · Operating Temperature -20°C / +50°C
Connection Καλώδιο / Wire · Material Σίδηρος - Πλαστικό / Iron - Plastic

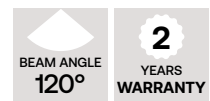

| Code | Barcode | Dimension (mm) ↕ ↔ ↕ | Watt | Weight (kg) | Packing | MOQ |
|-----------|---------------|-------------------------|---------------|-------------|---------|-----|
| 147-56020 | 5207227004124 | 610 x 130 x 45 | MAX 2X9W LED | 0.400 | 1/12 | 3 |
| 147-56021 | 5207227004148 | 1200 x 125 x 42 | MAX 2X18W LED | 0.816 | 1/10 | 3 |



Φωτιστικά Μεταλλικά Κενά Οβάλ με Γρίλιες
Lighting Metal Blanks Oval with Grilles



Volt 80-270V 50/60Hz · PF T8 · Operating Temperature -20°C / +50°C
Connection Καλώδιο / Wire · Material Σίδηρος - Πλαστικό / Iron - Plastic

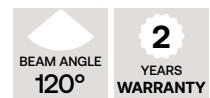

| Code | Barcode | Dimension (mm) ↕ ↔ ↕ | Watt | Weight (kg) | Packing | MOQ |
|-----------|---------------|-------------------------|---------------|-------------|---------|-----|
| 147-56022 | 5207227004162 | 610 x 130 x 45 | MAX 2X9W LED | 0.412 | 1/12 | 3 |
| 147-56023 | 5207227004186 | 1200 x 125 x 42 | MAX 2X18W LED | 0.823 | 1/10 | 3 |





PS
LED Driver

Φωτιστικά Γραμμικά Led Slim Value
Lighting Linear Led Slim Value



LED Type SMD2835 • Chip Brand Sanan • Volt 220-240V 50/60Hz
Start Time 0.5 sec • PF >0.90 • Operating Temperature -20°C / +45°C
Connection Τροφοδοσία από τις 2 πλευρές / 2 Way Connection
Material Πλαστικό / Plastic

LUMEN / WATT
lm/W
110

CRI
Ra
>80

BEAM ANGLE
120°

2
YEARS
WARRANTY

| Code | Barcode | Dimension (mm) ↕ ↔ ↕ | Watt | Amperage mA | Kelvin | Total Lumen | Weight (kg) | Packing | MOQ |
|-----------|---------------|-------------------------|------|----------------|--------|-------------|----------------|---------|-----|
| 147-56610 | 5207227068249 | 620 x 63 x 35 | 18 | 80 | 6500 | 1980 | 0.150 | 1/20 | 1 |
| 147-56611 | 5207227068263 | 620 x 63 x 35 | 18 | 80 | 4000 | 1980 | 0.150 | 1/20 | 1 |
| 147-56613 | 5207227068287 | 1280 x 55 x 35 | 36 | 162 | 6500 | 3960 | 0.250 | 1/20 | 1 |
| 147-56614 | 5207227068300 | 1220 x 63 x 35 | 36 | 162 | 4000 | 3960 | 0.250 | 1/20 | 1 |
| 147-56706 | 5207227428098 | 1256 x 78 x 38 | 60 | 240 | 6500 | 6600 | 0.400 | 1/30 | 1 |
| 147-56707 | 5207227428111 | 1256 x 78 x 38 | 60 | 240 | 4000 | 6600 | 0.400 | 1/30 | 1 |
| 147-56616 | 5207227068324 | 1520 x 63 x 35 | 45 | 205 | 6500 | 4950 | 0.350 | 1/20 | 1 |
| 147-56617 | 5207227068348 | 1520 x 63 x 35 | 45 | 205 | 4000 | 4950 | 0.350 | 1/20 | 1 |
| 147-56712 | 5207227428135 | 1556 x 78 x 38 | 80 | 350 | 6500 | 8800 | 0.500 | 1/30 | 1 |
| 147-56713 | 5207227428159 | 1556 x 78 x 38 | 80 | 350 | 4000 | 8800 | 0.500 | 1/30 | 1 |





Φωτιστικά Στεγανά για / Lighting Waterproof for T8 Led Tube IP65



T8
TYPE



Volt 80-270V 50/60Hz · Operating Temperature -20°C / +50°C
 Connection Τροφοδοσία από τις 2 πλευρές / 2 Way Connection
 Material Πολυκαρβονικό / Polycarbonate
 Μεταλλικά Κλιπς / Metallic Clips

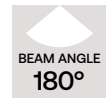

| Code | Barcode | Dimension (mm) | | | Watt | Weight (kg) | Packing | MOQ |
|-----------|---------------|----------------|-----|----|---------------|-------------|---------|-----|
| | | ↗ | ↔ | ↕ | | | | |
| 147-56060 | 5206139084279 | 670 | 68 | 74 | MAX 1X9W LED | 0.520 | 1/6 | 1 |
| 147-56061 | 5206139084293 | 1270 | 68 | 74 | MAX 1X18W LED | 0.930 | 1/6 | 1 |
| 147-56062 | 5206139084309 | 1570 | 68 | 74 | MAX 1X24W LED | 1.120 | 1/6 | 1 |
| 147-56063 | 5206139084316 | 670 | 104 | 74 | MAX 2X9W LED | 0.720 | 1/6 | 1 |
| 147-56064 | 5206139084323 | 1270 | 104 | 74 | MAX 2X18W LED | 1.200 | 1/6 | 1 |
| 147-56065 | 5206139078131 | 1570 | 104 | 74 | MAX 2X24W LED | 1.510 | 1/6 | 1 |



Οι λαμπτήρες περιλαμβάνονται
 Bulbs are included



Φωτιστικά Στεγανά με Led Tube IP65 Lighting Waterproof with Led Tube IP65



T8
TYPE



LED Type SMD2835 · Chip Brand BMTC · Volt 80-270V 50/60Hz Start Time 0.5 sec · PF >0.90
 Operating Temperature -20°C / +40°C · Connection Τροφοδοσία από τις 2 πλευρές / 2 Way Connection
 Material Πολυκαρβονικό / Polycarbonate
 Μεταλλικά Κλιπς / Metallic Clips

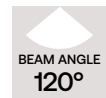

| Code | Barcode | Dimension (mm) | | | Watt | Amperage mA | Kelvin | Lumen/Watt | Weight (kg) | Packing | MOQ |
|-----------|---------------|----------------|-----|----|------|-------------|--------|------------|-------------|---------|-----|
| | | ↗ | ↔ | ↕ | | | | | | | |
| 147-56070 | 5207227274824 | 1272 | 66 | 73 | 18 | 240 | 4000 | 110 | 1.130 | 1/8 | 1 |
| 147-56071 | 5207227274848 | 1270 | 104 | 74 | 2x18 | 240 | 4000 | 110 | 1.740 | 1/10 | 1 |
| 147-56072 | 5207227274862 | 1572 | 66 | 73 | 24 | 350 | 4000 | 110 | 1.420 | 1/10 | 1 |
| 147-56073 | 5207227275494 | 1572 | 102 | 73 | 2x24 | 350 | 4000 | 110 | 2.090 | 1/9 | 1 |

| Διαστάσεις Dimensions | Τεμάχια Pcs |
|--------------------------|----------------|
| 1x1,2m | 110pcs |
| 2x1,2m | 70pcs |
| 1x1,5m | 110pcs |
| 2x1,5m | 70pcs |



Stand Χάρτινο για Στεγανά για Led Tube Paper Stand Lighting Waterproof for Led Tube

| Code | Barcode | LED Tube | Dimension (mm) | |
|-----------|---------------|----------|----------------|--------|
| | | | ↗ | ↕ |
| 147-56078 | 5207227275500 | 1,20m | 134 | 82x88 |
| 147-56079 | 5207227275517 | 1,50m | 161 | 74x109 |



3CCT

(3000K 4000K 6500K)



**Φωτιστικά Γραμμικά Στεγανά Led Slim
Lighting Linear Waterproof Led Slim**



LED Type SMD2835 • Chip Brand JINGRUI • Volt 220-240V 50/60Hz
Start Time 0.5 sec • PF >0.90 • Operating Temperature -20°C / +40°C
Connection Τροφοδοσία από τις 2 πλευρές / 2 Way Connection
Material Πολυκαρβονικό / Polycarbonate

LUMEN / WATT
lm/W
140

CRI
Ra
>80

BEAM ANGLE
120°

3
YEARS
WARRANTY

| Code | Barcode | Dimension (mm) ↕ ↔ ↗ | Watt | Amperage mA | Kelvin | Total Lumen | Weight (kg) | Packing | MOQ |
|-----------|---------------|-------------------------|------|----------------|--------|-------------|----------------|---------|-----|
| 147-56640 | 5207227288890 | 600 x 80 x 72 | 18 | 210 | 3CCT | 2520 | 0.800 | 1/9 | 1 |
| 147-56642 | 5207227288913 | 1200 x 80 x 72 | 36 | 230 | 3CCT | 5040 | 1.240 | 1/9 | 1 |
| 147-56644 | 5207227288937 | 1500 x 80 x 72 | 48 | 300 | 3CCT | 6720 | 1.580 | 1/9 | 1 |

LUMEN / WATT
lm/W
160



| Code | Barcode | Dimension (mm) ↕ ↔ ↗ | Watt | Amperage mA | Kelvin | Total Lumen | Weight (kg) | Packing | MOQ |
|-----------|---------------|-------------------------|------|----------------|--------|-------------|----------------|---------|-----|
| 147-56653 | 5207227288951 | 1200 x 80 x 72 | 36 | 230 | 6000 | 5760 | 1.100 | 1/9 | 1 |
| 147-56654 | 5207227288975 | 1200 x 80 x 72 | 36 | 230 | 4000 | 5760 | 1.100 | 1/9 | 1 |
| 147-56656 | 5207227288999 | 1500 x 80 x 72 | 48 | 300 | 6000 | 7680 | 1.470 | 1/9 | 1 |
| 147-56657 | 5207227289019 | 1500 x 80 x 72 | 48 | 300 | 4000 | 7680 | 1.470 | 1/9 | 1 |





3CCT

(3000K 4000K 6500K)



Φωτιστικά Γραμμικά Led Slim
Lighting Linear Led Slim



LED Type SMD2835 • Chip Brand MTC • Volt 220-240V 50/60Hz
Start Time 0.5 sec • PF >0.90 • Operating Temperature -20°C / +45°C
Connection Τροφοδοσία από τις 2 πλευρές / 2 Way Connection
Material Αλουμίνιο - Πλαστικό / Aluminium - Plastic

| | | | |
|-----------------------------|------------------|--------------------|------------------------|
| LUMEN / WATT lm/W 140 | CRI Ra >80 | BEAM ANGLE 120° | 3 YEARS WARRANTY |
|-----------------------------|------------------|--------------------|------------------------|

| Code | Barcode | Dimension (mm) ↕ ↔ ↗ | Watt | Amperage mA | Kelvin | Total Lumen | Weight (kg) | Packing | MOQ |
|-----------|---------------|-------------------------|----------|----------------|--------|-------------|----------------|---------|-----|
| 147-56660 | 5207227302411 | 600 x 80 x 72 | 10/15/20 | 50-80-100 | 3CCT | 2800 | 0.840 | 1/9 | 1 |
| 147-56661 | 5207227274541 | 1200 x 80 x 72 | 20/30/40 | 106-160-205 | 3CCT | 5600 | 1.454 | 1/9 | 1 |
| 147-56662 | 5207227274565 | 1500 x 80 x 72 | 30/40/50 | 116-159-197 | 3CCT | 7000 | 1.760 | 1/9 | 1 |

Φωτιστικά Γραμμικά Led Slim με Μπαταρία (Φωτισμός Ασφαλείας)
Lighting Linear Led Slim with Battery (Emergency Light)



Τύπος Μπαταρίας / Battery Type LiFePO4, 3600mA
Χρόνος Φόρτισης / Battery Charging Time >24h • Χρόνος Αποφόρτισης / Discharging Time 3h, 450lm

| Code | Barcode | Dimension (mm) ↕ ↔ ↗ | Watt | Amperage mA | Kelvin | Total Lumen | Weight (kg) | Packing | MOQ |
|-----------|---------------|-------------------------|----------|----------------|--------|-------------|----------------|---------|-----|
| 147-56670 | 5207227302237 | 600 x 80 x 72 | 10/15/20 | 50-80-100 | 3CCT | 2800 | 0.862 | 1/9 | 1 |
| 147-56671 | 5207227274602 | 1200 x 80 x 72 | 20/30/40 | 106-160-205 | 3CCT | 5600 | 1.788 | 1/9 | 1 |



3CCT

(3000K 4000K 6500K)

Απόσταση Ανίχνευσης / Detection Distance 12m



Φωτιστικά Γραμμικά με Ανιχνευτή Κίνησης
Lighting Linear with Motion Detector



LED Type SMD2835 • Chip Brand MTC • Volt 220-240V 50/60Hz
Start Time 0.5 sec • PF >0.90 • Operating Temperature -20°C / +45°C
Connection Τροφοδοσία από τις 2 πλευρές / 2 Way Connection
Material Αλουμίνιο - Πλαστικό / Aluminium - Plastic

| | | | |
|-----------------------------|------------------|--------------------|------------------------|
| LUMEN / WATT lm/W 140 | CRI Ra >80 | BEAM ANGLE 120° | 3 YEARS WARRANTY |
|-----------------------------|------------------|--------------------|------------------------|

| Code | Barcode | Dimension (mm) ↕ ↔ ↗ | Watt | Amperage mA | Kelvin | Total Lumen | Weight (kg) | Packing | MOQ |
|-----------|---------------|-------------------------|----------|----------------|--------|-------------|----------------|---------|-----|
| 147-56675 | 5207227302244 | 600 x 80 x 72 | 10/15/20 | 50-80-100 | 3CCT | 2800 | 1.160 | 1/9 | 1 |
| 147-56676 | 5207227274589 | 1200 x 80 x 72 | 20/30/40 | 106-160-205 | 3CCT | 5600 | 1.476 | 1/9 | 1 |



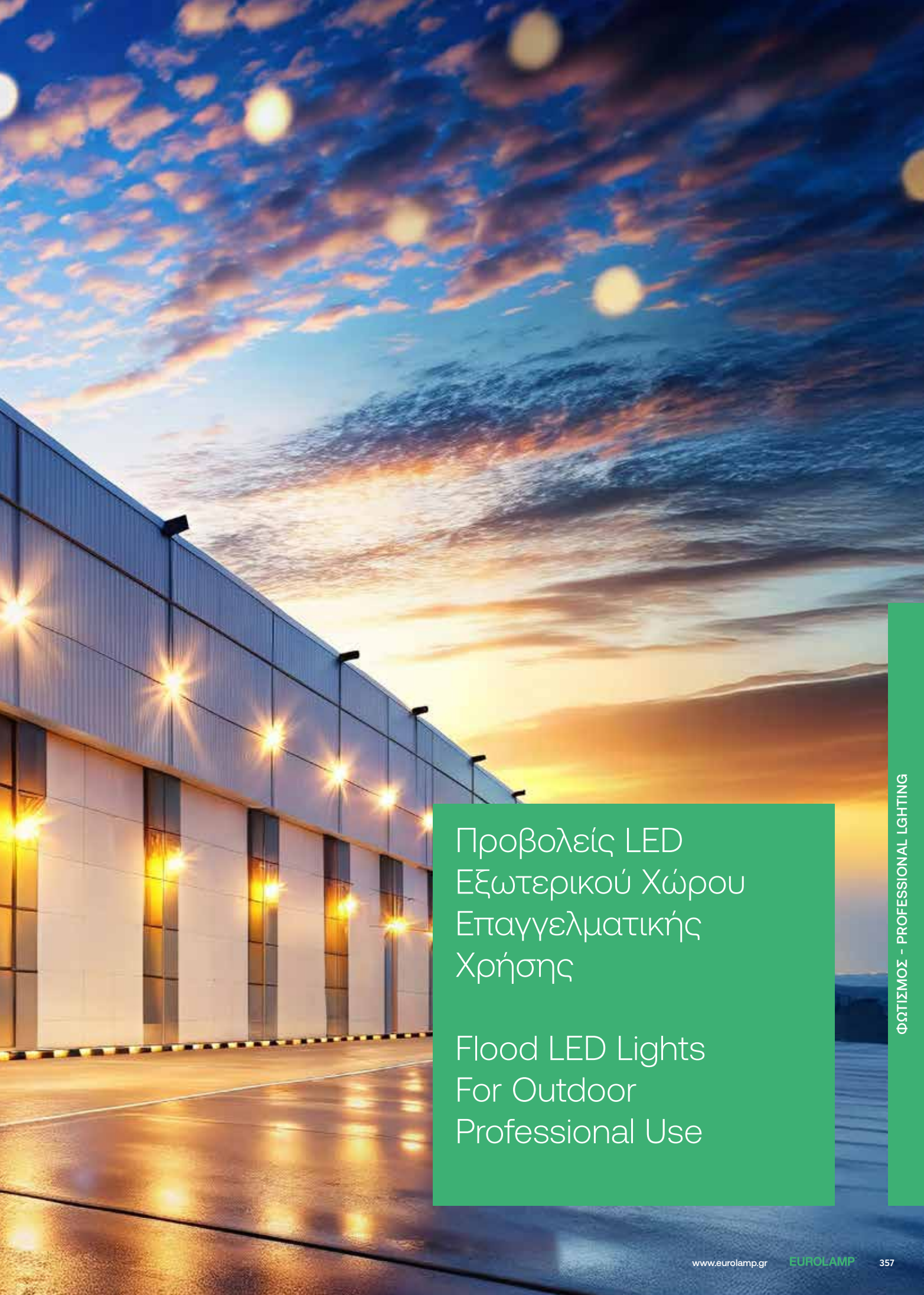

Προβολείς LED
Εξωτερικού Χώρου
Επαγγελματικής
Χρήσης

Flood LED Lights
For Outdoor
Professional Use



SMD 77x89x22mm



EVR
LED Driver

● Μαύρο/Black
● Λευκό/White

LED Type SMD2835 • Chip Brand Sanan • Volt 160-265V 50/60Hz
Start Time 0.5 sec • PF >0.90 • Operating Temperature -20°C / +50°C
Connection Καλώδιο / Wire • Material Αλουμίνιο - Γυαλί / Aluminium - Glass

| | | | | |
|------------------------------------|-------------------------|---------------------------|--------------|------------------|
| LUMEN / WATT lm/W 120 | CRI Ra >70 | BEAM ANGLE 120° | NON DIMMABLE | 3 YEARS WARRANTY |
|------------------------------------|-------------------------|---------------------------|--------------|------------------|

| Code | Barcode | Dimension (mm) | | | Watt | Total Lumen | Kelvin | Weight (kg) | Color | Packing | MOQ |
|-----------|---------------|----------------|------|----|------|-------------|--------|-------------|-------|---------|-----|
| | | ↗ | ↔ | ↓ | | | | | | | |
| 147-69000 | 5207227411762 | 22 x | 77 x | 89 | 10 | 1200 | 6500 | 0.165 | BLACK | 1\50 | 1 |
| 147-69001 | 5207227411786 | 22 x | 77 x | 89 | 10 | 1200 | 4000 | 0.165 | BLACK | 1\50 | 1 |
| 147-69002 | 5207227411809 | 22 x | 77 x | 89 | 10 | 1200 | 3000 | 0.165 | BLACK | 1\50 | 1 |
| 147-69030 | 5207227412264 | 22 x | 77 x | 89 | 10 | 1200 | 6500 | 0.165 | WHITE | 1\50 | 1 |
| 147-69031 | 5207227412288 | 22 x | 77 x | 89 | 10 | 1200 | 4000 | 0.165 | WHITE | 1\50 | 1 |
| 147-69032 | 5207227412301 | 22 x | 77 x | 89 | 10 | 1200 | 3000 | 0.165 | WHITE | 1\50 | 1 |



SMD 91x105x23mm



EVR
LED Driver

● Μαύρο/Black
● Λευκό/White

LED Type SMD2835 • Chip Brand Sanan • Volt 160-265V 50/60Hz
Start Time 0.5 sec • PF >0.90 • Operating Temperature -20°C / +50°C
Connection Καλώδιο / Wire • Material Αλουμίνιο - Γυαλί / Aluminium - Glass

| | | | | |
|------------------------------------|-------------------------|---------------------------|--------------|------------------|
| LUMEN / WATT lm/W 120 | CRI Ra >70 | BEAM ANGLE 120° | NON DIMMABLE | 3 YEARS WARRANTY |
|------------------------------------|-------------------------|---------------------------|--------------|------------------|

| Code | Barcode | Dimension (mm) | | | Watt | Total Lumen | Kelvin | Weight (kg) | Color | Packing | MOQ |
|-----------|---------------|----------------|------|-----|------|-------------|--------|-------------|-------|---------|-----|
| | | ↗ | ↔ | ↓ | | | | | | | |
| 147-69003 | 5207227411823 | 23 x | 91 x | 105 | 20 | 2400 | 6500 | 0.219 | BLACK | 1\20 | 1 |
| 147-69004 | 5207227411847 | 23 x | 91 x | 105 | 20 | 2400 | 4000 | 0.219 | BLACK | 1\20 | 1 |
| 147-69005 | 5207227411861 | 23 x | 91 x | 105 | 20 | 2400 | 3000 | 0.219 | BLACK | 1\20 | 1 |
| 147-69033 | 5207227412325 | 23 x | 91 x | 105 | 20 | 2400 | 6500 | 0.219 | WHITE | 1\20 | 1 |
| 147-69034 | 5207227412349 | 23 x | 91 x | 105 | 20 | 2400 | 4000 | 0.219 | WHITE | 1\20 | 1 |
| 147-69035 | 5207227412363 | 23 x | 91 x | 105 | 20 | 2400 | 3000 | 0.219 | WHITE | 1\20 | 1 |

Ενσωματωμένο στην πλακέτα/
Embedded in plate

Γαλβανιζέ βίδες
Galvanized bolts

2-3m
Installation
Height

EVR
LED Driver

Μαύρο/Black
Λευκό/White

PLUS
SERIES

NEW

30.000h ON OFF 25.000 IP66 CLASS I IK06 CE E

SMD 120x140x31mm

LED Type SMD2835 • Chip Brand Sanan • Volt 160-265V 50/60Hz
Start Time 0.5 sec • PF >0.90 • Operating Temperature -20°C / +50°C
Connection Καλώδιο / Wire • Material Αλουμίνιο - Γυαλί / Aluminium - Glass

| | | | | |
|-----------------------------|------------------|--------------------|--------------|------------------|
| LUMEN / WATT lm/W 120 | CRI Ra >70 | BEAM ANGLE 120° | NON DIMMABLE | 3 YEARS WARRANTY |
|-----------------------------|------------------|--------------------|--------------|------------------|

| Code | Barcode | Dimension (mm) ↗ ↔ ↘ | Watt | Total Lumen | Kelvin | Weight (kg) | Color | Packing | MOQ |
|-----------|---------------|-------------------------|------|-------------|--------|-------------|-------|---------|-----|
| 147-69006 | 5207227411885 | 31 x 120 x 140 | 30 | 3600 | 6500 | 0.354 | BLACK | 1\20 | 1 |
| 147-69007 | 5207227411908 | 31 x 120 x 140 | 30 | 3600 | 4000 | 0.354 | BLACK | 1\20 | 1 |
| 147-69008 | 5207227411922 | 31 x 120 x 140 | 30 | 3600 | 3000 | 0.354 | BLACK | 1\20 | 1 |
| 147-69036 | 5207227412387 | 31 x 120 x 140 | 30 | 3600 | 6500 | 0.354 | WHITE | 1\20 | 1 |
| 147-69037 | 5207227412400 | 31 x 120 x 140 | 30 | 3600 | 4000 | 0.354 | WHITE | 1\20 | 1 |
| 147-69038 | 5207227412424 | 31 x 120 x 140 | 30 | 3600 | 3000 | 0.354 | WHITE | 1\20 | 1 |

Ενσωματωμένο στην πλακέτα/
Embedded in plate

Γαλβανιζέ βίδες
Galvanized bolts

2-3m
Installation
Height

EVR
LED Driver

Μαύρο/Black
Λευκό/White

PLUS
SERIES

NEW

30.000h ON OFF 25.000 IP66 CLASS I IK06 CE E

SMD 146x170x31mm

LED Type SMD2835 • Chip Brand Sanan • Volt 160-265V 50/60Hz
Start Time 0.5 sec • PF >0.90 • Operating Temperature -20°C / +50°C
Connection Καλώδιο / Wire • Material Αλουμίνιο - Γυαλί / Aluminium - Glass

| | | | | |
|-----------------------------|------------------|--------------------|--------------|------------------|
| LUMEN / WATT lm/W 120 | CRI Ra >70 | BEAM ANGLE 120° | NON DIMMABLE | 3 YEARS WARRANTY |
|-----------------------------|------------------|--------------------|--------------|------------------|

| Code | Barcode | Dimension (mm) ↗ ↔ ↘ | Watt | Total Lumen | Kelvin | Weight (kg) | Color | Packing | MOQ |
|-----------|---------------|-------------------------|------|-------------|--------|-------------|-------|---------|-----|
| 147-69009 | 5207227411946 | 31 x 146 x 170 | 50 | 6000 | 6500 | 0.540 | BLACK | 1\20 | 1 |
| 147-69010 | 5207227411960 | 31 x 146 x 170 | 50 | 6000 | 4000 | 0.540 | BLACK | 1\20 | 1 |
| 147-69011 | 5207227411984 | 31 x 146 x 170 | 50 | 6000 | 3000 | 0.540 | BLACK | 1\20 | 1 |
| 147-69039 | 5207227412448 | 31 x 146 x 170 | 50 | 6000 | 6500 | 0.540 | WHITE | 1\20 | 1 |
| 147-69040 | 5207227412462 | 31 x 146 x 170 | 50 | 6000 | 4000 | 0.540 | WHITE | 1\20 | 1 |
| 147-69041 | 5207227412486 | 31 x 146 x 170 | 50 | 6000 | 3000 | 0.540 | WHITE | 1\20 | 1 |



Γαλβανιζέ βίδες
Galvanized bolts

• Ενσωματωμένο στην πλακέτα/
Embedded in plate



3-5m
Installation
Height

EV
LED Driver

● Μαύρο/Black

SMD 184x215x32mm



LED Type SMD2835 • Chip Brand Sanan • Volt 160-265V 50/60Hz
Start Time 0.5 sec • PF >0.90 • Operating Temperature -20°C / +50°C
Connection Καλώδιο / Wire • Material Αλουμίνιο - Γυαλί / Aluminium - Glass

LUMEN / WATT
lm/W
120

CRI
Ra
>70

BEAM ANGLE
120°

NON
DIMMABLE

3
YEARS
WARRANTY

| Code | Barcode | Dimension (mm) | | | Watt | Total Lumen | Kelvin | Weight (kg) | Packing | MOQ |
|-----------|---------------|----------------|-------|-----|------|-------------|--------|-------------|---------|-----|
| | | ↕ | ↔ | ↕ | | | | | | |
| 147-69012 | 5207227412004 | 32 x | 184 x | 215 | 70 | 8400 | 6500 | 0.850 | 1\10 | 1 |
| 147-69013 | 5207227412028 | 32 x | 184 x | 215 | 70 | 8400 | 4000 | 0.850 | 1\10 | 1 |
| 147-69014 | 5207227412042 | 32 x | 184 x | 215 | 70 | 8400 | 3000 | 0.850 | 1\10 | 1 |
| 147-69015 | 5207227412066 | 32 x | 184 x | 215 | 100 | 12000 | 6500 | 0.850 | 1\10 | 1 |
| 147-69016 | 5207227412080 | 32 x | 184 x | 215 | 100 | 12000 | 4000 | 0.850 | 1\10 | 1 |
| 147-69017 | 5207227412103 | 32 x | 184 x | 215 | 100 | 12000 | 3000 | 0.850 | 1\10 | 1 |



Γαλβανιζέ βίδες
Galvanized bolts

• Ενσωματωμένο στην πλακέτα/
Embedded in plate

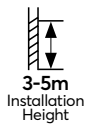

3-5m
Installation
Height

EV
LED Driver

● Μαύρο/Black

SMD 215x250x32mm



LED Type SMD2835 • Chip Brand Sanan • Volt 160-265V 50/60Hz
Start Time 0.5 sec • PF >0.90 • Operating Temperature -20°C / +50°C
Connection Καλώδιο / Wire • Material Αλουμίνιο - Γυαλί / Aluminium - Glass

LUMEN / WATT
lm/W
120

CRI
Ra
>70

BEAM ANGLE
120°

NON
DIMMABLE

3
YEARS
WARRANTY

| Code | Barcode | Dimension (mm) | | | Watt | Total Lumen | Kelvin | Weight (kg) | Packing | MOQ |
|-----------|---------------|----------------|-------|-----|------|-------------|--------|-------------|---------|-----|
| | | ↕ | ↔ | ↕ | | | | | | |
| 147-69018 | 5207227412127 | 32 x | 215 x | 250 | 150 | 18000 | 6500 | 1.182 | 1\10 | 1 |
| 147-69019 | 5207227412141 | 32 x | 215 x | 250 | 150 | 18000 | 4000 | 1.182 | 1\10 | 1 |
| 147-69020 | 5207227412165 | 32 x | 215 x | 250 | 150 | 18000 | 3000 | 1.182 | 1\10 | 1 |



Ενσωματωμένο στην πλακέτα/
Embedded in plate



3-5m
Installation
Height

EV
LED Driver

● Μαύρο/Black

SMD 252x294x37mm



LED Type SMD2835 • Chip Brand Sanan • Volt 160-265V 50/60Hz
Start Time 0.5 sec • PF >0.90 • Operating Temperature -20°C / +50°C
Connection Καλώδιο / Wire • Material Αλουμίνιο - Γυαλί / Aluminium - Glass

| | | | | |
|-----------------------------|------------------|--------------------|-----------------|------------------------|
| LUMEN / WATT lm/W 120 | CRI Ra >70 | BEAM ANGLE 120° | NON DIMMABLE | 3 YEARS WARRANTY |
|-----------------------------|------------------|--------------------|-----------------|------------------------|

| Code | Barcode | Dimension (mm) | | | Watt | Total Lumen | Kelvin | Weight (kg) | Packing | MOQ |
|-----------|---------------|----------------|-----|-----|------|----------------|--------|----------------|---------|-----|
| | | ↗ | ↔ | ↘ | | | | | | |
| 147-69021 | 5207227412189 | 37 | 252 | 294 | 200 | 24000 | 6500 | 1.670 | 1\10 | 1 |
| 147-69022 | 5207227412202 | 37 | 252 | 294 | 200 | 24000 | 4000 | 1.670 | 1\10 | 1 |



Ενσωματωμένο στην πλακέτα/
Embedded in plate



5-8m
Installation
Height

EV
LED Driver

● Μαύρο/Black

SMD 322x352x45mm



LED Type SMD2835 • Chip Brand Sanan • Volt 160-265V 50/60Hz
Start Time 0.5 sec • PF >0.90 • Operating Temperature -20°C / +50°C
Connection Καλώδιο / Wire • Material Αλουμίνιο - Γυαλί / Aluminium - Glass

| | | | | |
|-----------------------------|------------------|--------------------|-----------------|------------------------|
| LUMEN / WATT lm/W 120 | CRI Ra >70 | BEAM ANGLE 120° | NON DIMMABLE | 3 YEARS WARRANTY |
|-----------------------------|------------------|--------------------|-----------------|------------------------|

| Code | Barcode | Dimension (mm) | | | Watt | Total Lumen | Kelvin | Weight (kg) | Packing | MOQ |
|-----------|---------------|----------------|-----|-----|------|----------------|--------|----------------|---------|-----|
| | | ↗ | ↔ | ↘ | | | | | | |
| 147-69023 | 5207227412226 | 45 | 322 | 352 | 300 | 36000 | 6500 | 2.100 | 1\10 | 1 |
| 147-69024 | 5207227412240 | 45 | 322 | 352 | 300 | 36000 | 4000 | 2.100 | 1\10 | 1 |



Ενσωματωμένο στην πλακέτα/
Embedded in plate



EVR
LED Driver

● Μαύρο/Black

SMD 10-50W
με 60cm Καλώδιο - with 60cm Cable



LED Type SMD2835 • Chip Brand Sanan • Volt 160-265V 50/60Hz
Start Time 0.5 sec • PF >0.90 • Operating Temperature -20°C / +50°C
Connection Καλώδιο / Wire • Material Αλουμίνιο - Γυαλί / Aluminium - Glass

| | | | | |
|-----------------------------|------------------|--------------------|-----------------|------------------------|
| LUMEN / WATT lm/W 120 | CRI Ra >70 | BEAM ANGLE 120° | NON DIMMABLE | 3 YEARS WARRANTY |
|-----------------------------|------------------|--------------------|-----------------|------------------------|

| Code | Barcode | Dimension (mm) | | | Watt | Total Lumen | Kelvin | Weight (kg) | Packing | MOQ |
|-----------|---------------|----------------|-----|----|------|-------------|--------|-------------|---------|-----|
| | | ↕ | ↔ | ↕ | | | | | | |
| 147-69801 | 5207227412721 | 77 | 89 | 22 | 10 | 1200 | 4000 | 0.165 | 1\50 | 1 |
| 147-69802 | 5207227412745 | 77 | 89 | 22 | 10 | 1200 | 3000 | 0.165 | 1\50 | 1 |
| 147-69803 | 5207227412769 | 91 | 105 | 23 | 20 | 2400 | 4000 | 0.219 | 1\20 | 1 |
| 147-69804 | 5207227412783 | 91 | 105 | 23 | 20 | 2400 | 3000 | 0.219 | 1\20 | 1 |
| 147-69805 | 5207227412806 | 120 | 140 | 31 | 30 | 3600 | 4000 | 0.354 | 1\20 | 1 |
| 147-69806 | 5207227412820 | 120 | 140 | 31 | 30 | 3600 | 3000 | 0.354 | 1\20 | 1 |
| 147-69807 | 5207227412844 | 146 | 170 | 31 | 50 | 6000 | 4000 | 0.540 | 1\20 | 1 |
| 147-69808 | 5207227412868 | 142 | 170 | 31 | 50 | 6000 | 3000 | 0.540 | 1\20 | 1 |





Detection Range: 120°
 Working Temperature: -20~+40°C
 Working Humidity: <93%RH
 Installation Height: 1.8m~2.5m
 Detection Motion Speed: 0.6~1.5m/s
 Detection Distance: 2-8m (<24°C)

- Αισθητήρας Μικροκυμάτων/
Microwave Sensor
- Ενσωματωμένο στην πλακέτα/
Embedded in plate

Turning the SENS dial anticlockwise will decrease the detection range (2m-10m).
 Turning the TIME dial anticlockwise will decrease the hold time (10 seconds-7minutes).
 Turning the LUX dial anticlockwise will restrict activation to lower light conditions(3-2000lux).



Γαλβανιζέ βίδες
Galvanized bolts



EVR
LED Driver

● Μαύρο/Black

Με Περιστρεφόμενο Ανιχνευτή Κίνησης 10W-50W
 With Rotating Motion Detector 10W-50W



LED Type SMD2835 • Chip Brand Sanan • Volt 160-265V 50/60Hz
 Start Time 0.5 sec • PF >0.90 • Operating Temperature -20°C / +50°C
 Connection Καλώδιο / Wire • Material Αλουμίνιο - Γυαλί / Aluminium - Glass

LUMEN / WATT
lm/W
120

CRI
Ra
>70

BEAM ANGLE
120°

NON DIMMABLE

3 YEARS WARRANTY

| Code | Barcode | Dimension (mm) | | | Watt | Total Lumen | Kelvin | Weight (kg) | Packing | MOQ |
|-----------|---------------|----------------|-------|----|------|-------------|--------|-------------|---------|-----|
| | | ↗ | ↔ | ↕ | | | | | | |
| 147-69060 | 5207227412509 | 77 x | 89 x | 22 | 10 | 1200 | 6500 | 0.225 | 1\50 | 1 |
| 147-69061 | 5207227412523 | 77 x | 89 x | 22 | 10 | 1200 | 4000 | 0.225 | 1\50 | 1 |
| 147-69062 | 5207227462740 | 77 x | 89 x | 22 | 10 | 1200 | 3000 | 0.225 | 1\50 | 1 |
| 147-69063 | 5207227412547 | 91 x | 105 x | 23 | 20 | 2400 | 6500 | 0.280 | 1\20 | 1 |
| 147-69064 | 5207227412561 | 91 x | 105 x | 23 | 20 | 2400 | 4000 | 0.280 | 1\20 | 1 |
| 147-69065 | 5207227462757 | 91 x | 105 x | 23 | 20 | 2400 | 3000 | 0.280 | 1\20 | 1 |
| 147-69066 | 5207227412585 | 120 x | 140 x | 31 | 30 | 3600 | 6500 | 0.420 | 1\20 | 1 |
| 147-69067 | 5207227412608 | 120 x | 140 x | 31 | 30 | 3600 | 4000 | 0.420 | 1\20 | 1 |
| 147-69068 | 5207227427169 | 120 x | 140 x | 31 | 30 | 3600 | 3000 | 0.420 | 1\20 | 1 |
| 147-69069 | 5207227412622 | 146 x | 170 x | 31 | 50 | 6000 | 6500 | 0.600 | 1\20 | 1 |
| 147-69070 | 5207227412646 | 146 x | 170 x | 31 | 50 | 6000 | 4000 | 0.600 | 1\20 | 1 |
| 147-69071 | 5207227462764 | 146 x | 170 x | 31 | 50 | 6000 | 3000 | 0.600 | 1\20 | 1 |



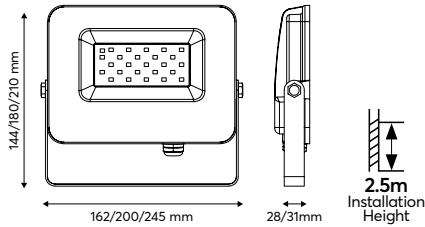

- Ανάβει αυτόματα όταν το φως του περιβάλλοντα χώρου είναι κάτω από 30 LUX.
- Σβήνει αυτόματα όταν το φως του περιβάλλοντα χώρου είναι πάνω από 50 LUX.

- Turns on automatically when the light of the surrounding area is below 30 LUX.
- Turns off automatically when the light of the surrounding area is over 50 LUX.

DOB
LED Driver

● Γραφίτης / Dark Grey

**Με Ανιχνευτή Ημέρας - Νύχτας
With Day - Night Sensor**



LED Type SMD2835 • Chip Brand Epistar • Volt 220-240V 50/60Hz
Start Time 0.5 sec • PF >0.90 • Operating Temperature -40°C / +50°C
Connection Καλώδιο / Wire • Material Αλουμίνιο - Γυαλί / Aluminium - Glass

| | | | | |
|----------------------------|------------------|--------------------|--------------|------------------|
| LUMEN / WATT lm/W 85 | CRI Ra >80 | BEAM ANGLE 100° | NON DIMMABLE | 2 YEARS WARRANTY |
|----------------------------|------------------|--------------------|--------------|------------------|

| Code | Barcode | Dimension (mm) | | | Watt | Total Lumen | Kelvin | Weight (kg) | Packing | MOQ |
|-----------|---------------|----------------|-----|----|------|-------------|--------|-------------|---------|-----|
| | | ↕ | ↔ | ↕ | | | | | | |
| 147-69360 | 5207227067518 | 162 | 144 | 28 | 20 | 1700 | 6500 | 0.370 | 1\30 | 1 |
| 147-69362 | 5207227067556 | 200 | 180 | 28 | 30 | 2550 | 6500 | 0.580 | 1\20 | 1 |
| 147-69364 | 5207227067594 | 245 | 210 | 31 | 50 | 4250 | 6500 | 0.880 | 1\10 | 1 |

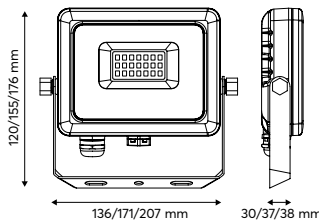

OTX
LED Driver

● Μαύρο / Black

10W - 30W 12V/24V AC/DC



LED Type SMD2835 • Chip Brand Epistar • Volt 12/24V
Start Time 0.5 sec • PF >0.90 • Operating Temperature -40°C / +50°C
Connection Καλώδιο / Wire • Material Αλουμίνιο - Γυαλί / Aluminium - Glass

| | | | | |
|----------------------------|------------------|--------------------|--------------|------------------|
| LUMEN / WATT lm/W 85 | CRI Ra >80 | BEAM ANGLE 100° | NON DIMMABLE | 2 YEARS WARRANTY |
|----------------------------|------------------|--------------------|--------------|------------------|

| Code | Barcode | Dimension (mm) | | | Watt | Total Lumen | Kelvin | Weight (kg) | Packing | MOQ |
|-----------|---------------|----------------|-----|----|------|-------------|--------|-------------|---------|-----|
| | | ↕ | ↔ | ↕ | | | | | | |
| 147-69383 | 5207227149474 | 136 | 120 | 30 | 10 | 850 | 6500 | 0.500 | 1\20 | 1 |
| 147-69384 | 5207227149481 | 171 | 155 | 37 | 20 | 1700 | 6500 | 0.623 | 1\20 | 1 |
| 147-69385 | 5207227149498 | 207 | 176 | 38 | 30 | 2550 | 6500 | 0.800 | 1\10 | 1 |

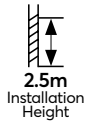
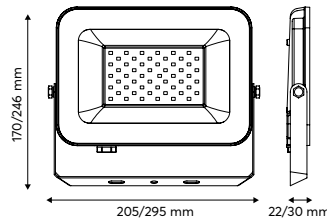

OTX
LED Driver

● Μαύρο/Black

100W SMD 42V



LED Type SMD2835 • Chip Brand Sanan • Volt 42V
Start Time 0.5 sec • Operating Temperature -20°C / +40°C
Connection Καλώδιο / Wire • Material Αλουμίνιο - Γυαλί / Aluminium - Glass

| | | | | |
|-----------------------------|------------------|--------------------|--------------|------------------|
| LUMEN / WATT lm/W 100 | CRI Ra >70 | BEAM ANGLE 120° | NON DIMMABLE | 2 YEARS WARRANTY |
|-----------------------------|------------------|--------------------|--------------|------------------|

| Code | Barcode | Dimension (mm) | | | Watt | Total Lumen | Kelvin | Weight (kg) | Packing | MOQ |
|-----------|---------------|----------------|-----|----|------|-------------|--------|-------------|---------|-----|
| | | ↗ | ↔ | ↘ | | | | | | |
| 147-69386 | 5207227257407 | 205 | 170 | 22 | 50 | 5000 | 6500 | 0.500 | 1\20 | 1 |
| 147-69387 | 5207227257421 | 295 | 246 | 30 | 100 | 10000 | 6500 | 1.230 | 1\10 | 1 |

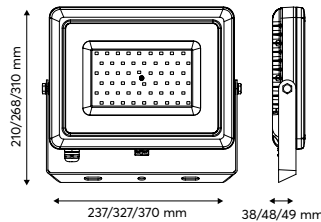

OTX
LED Driver

● Μαύρο/Black

• Κατάλληλο για πλοία
Suitable for ships

SMD 50W IP66 80-265V



LED Type SMD2835 • Chip Brand Lumileds • Volt 80-265V 50/60Hz
Start Time 0.5 sec • PF >0.90 • Operating Temperature -20°C / +40°C
Connection Καλώδιο / Wire • Material Αλουμίνιο - Γυαλί / Aluminium - Glass

| | | | | |
|-----------------------------|------------------|--------------------|--------------|------------------|
| LUMEN / WATT lm/W 130 | CRI Ra >70 | BEAM ANGLE 120° | NON DIMMABLE | 3 YEARS WARRANTY |
|-----------------------------|------------------|--------------------|--------------|------------------|

| Code | Barcode | Dimension (mm) | | | Watt | Total Lumen | Kelvin | Weight (kg) | Packing | MOQ |
|-----------|---------------|----------------|-----|----|------|-------------|--------|-------------|---------|-----|
| | | ↗ | ↔ | ↘ | | | | | | |
| 147-69300 | 5207227257452 | 237 | 210 | 38 | 50 | 6500 | 6500 | 1.200 | 1\10 | 1 |
| 147-69302 | 5207227257476 | 327 | 268 | 48 | 100 | 13000 | 6500 | 2.550 | 1\5 | 1 |
| 147-69304 | 5207227257490 | 370 | 310 | 49 | 150 | 19500 | 6500 | 3.650 | 1\4 | 1 |



Ενσωματωμένο στην πλακέτα/
Embedded in plate
Επιπλέον Αντάπτορας Αυτοκινήτου/
Car's Adaptor
Battery type: 18650 Lithium 3.7V
Charging cable: 8,4V 1A
Charging Time: 3h
Discharging Time: 4-5h

EVR
LED Driver

● Μαύρο-Κίτρινο/Black-Yellow

SMD 222x126x136mm
Επαναφορτιζόμενο - Rechargeable



LED Type SMD2835 • Chip Brand Genesis • Volt 100-240V 50/60Hz
Start Time 3 sec • PF >0.60 • Operating Temperature -20°C / +50°C
Connection Καλώδιο / Wire
Material Πλαστικό - Αλουμίνιο - Σίδηρος / Plastic - Aluminium - Iron

| | | | | |
|-----------------------------------|-------------------------|---------------------------|--------------|------------------|
| LUMEN / WATT lm/W 70 | CRI Ra >80 | BEAM ANGLE 120° | NON DIMMABLE | 2 YEARS WARRANTY |
|-----------------------------------|-------------------------|---------------------------|--------------|------------------|

| | Barcode | Dimension (mm) ↕ ↔ ↕ | Watt | Total Lumen | Kelvin | Weight (kg) | Packing | MOQ |
|------------------|---------------|-------------------------|------|-------------|--------|-------------|---------|-----|
| 147-69240 | 5206139050212 | 222 x 126 x 136 | 10 | 700 | 4000 | 0.880 | 1\20 | 1 |
| 147-69241 | 5206139050236 | 222 x 126 x 136 | 20 | 1400 | 4000 | 0.880 | 1\20 | 1 |

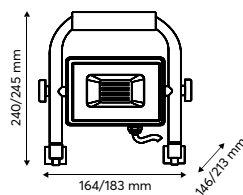

Ενσωματωμένο στην πλακέτα/
Embedded in plate

DOB
LED Driver

● Μαύρο-Κίτρινο/Black-Yellow

SMD 10W-30W
Φορητός - Portable



LED Type SMD2835 • Chip Brand Sanan • Volt 220-240V 50/60Hz
Start Time 0.5 sec • PF >0.90 • Operating Temperature -40°C / +50°C
Connection Καλώδιο / Wire • Material Αλουμίνιο - Γυαλί / Aluminium - Glass

| | | | | |
|-----------------------------------|-------------------------|---------------------------|--------------|------------------|
| LUMEN / WATT lm/W 80 | CRI Ra >70 | BEAM ANGLE 120° | NON DIMMABLE | 2 YEARS WARRANTY |
|-----------------------------------|-------------------------|---------------------------|--------------|------------------|

| Code | Barcode | Dimension (mm) ↕ ↔ ↕ | Watt | Total Lumen | Kelvin | Weight (kg) | Packing | MOQ |
|------------------|---------------|-------------------------|------|-------------|--------|-------------|---------|-----|
| 147-69370 | 5207227068744 | 146 x 164 x 240 | 10 | 800 | 4000 | 0.685 | 1\20 | 1 |
| 147-69372 | 5207227068768 | 213 x 183 x 245 | 30 | 2400 | 4000 | 0.880 | 1\10 | 1 |



147-22420
147-22421



147-22422

 Κίτρινο/Yellow

Βάση για Προβολείς - Projector Stand LED



Material Αλουμίνιο/Aluminium

| Code | Barcode | Dimension (mm) ↗ ↔ ↘ | Weight (kg) | Packing | MOQ |
|-----------|---------------|-------------------------|-------------|---------|-----|
| 147-22420 | 5206139044914 | 265 x 75 x 205 | 0.500 | 1\20 | 1 |
| 147-22421 | 5206139044945 | 345 x 105 x 280 | 1.200 | 1\10 | 1 |

| Code | Barcode | Dimension Ø (mm) ↕ | Weight (kg) | Packing | MOQ |
|-----------|---------------|-----------------------|-------------|---------|-----|
| 147-22422 | 5206139044891 | 960 x 1500 | 1.000 | 1\6 | 1 |



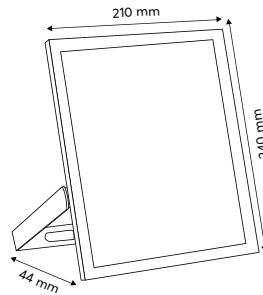

- Ενοσωματωμένο στην πλακέτα/
Embedded in plate
- With controller /include baterries



On-Bright
LED Driver

● Μαύρο/Black

SMD RGB 50W



LED Type SMD2835 • Chip Brand Sanan • Volt 100-265V 50/60Hz
Start Time 0.5 sec • PF >0.90 • Operating Temperature -40°C / +50°C
Connection Καλώδιο / Wire • Material Αλουμίνιο - Γυαλί / Aluminium - Glass

| | | | | |
|----------------------------|------------------|--------------------|--------------|------------------|
| LUMEN / WATT lm/W 80 | CRI Ra >80 | BEAM ANGLE 120° | NON DIMMABLE | 2 YEARS WARRANTY |
|----------------------------|------------------|--------------------|--------------|------------------|

| Code | Barcode | Dimension (mm) ↕ ↔ ↔ | Watt | Amperage mA | Kelvin | Weight (kg) | Packing | MOQ |
|-----------|---------------|-------------------------|------|----------------|--------|----------------|---------|-----|
| 147-69390 | 5207227068782 | 240 x 44 x 210 | 50 | 560 | RGB | 1.168 | 1\10 | 1 |



- Ενοσωματωμένο στην πλακέτα/
Embedded in plate



EVR
LED Driver

● Μαύρο/Black

**10W SMD IP66
Πράσινος/Μπλε - Green/Blue**



LED Type SMD2835 • Chip Brand Sanan • Volt 100-265V 50/60Hz
Start Time 0.5 sec • PF >0.90 • Operating Temperature -20°C / +50°C
Connection Καλώδιο / Wire • Material Αλουμίνιο - Γυαλί / Aluminium - Glass

| | | | | |
|-----------------------------|------------------|--------------------|--------------|------------------|
| LUMEN / WATT lm/W 120 | CRI Ra >70 | BEAM ANGLE 120° | NON DIMMABLE | 3 YEARS WARRANTY |
|-----------------------------|------------------|--------------------|--------------|------------------|

| Code | Barcode | Dimension (mm) ↕ ↔ ↔ | Watt | Total Lumen | Kelvin | Weight (kg) | Packing | MOQ |
|-----------|---------------|-------------------------|------|-------------|--------|----------------|---------|-----|
| 147-69280 | 5207227412660 | 77 x 89 x 22 | 10 | 1200 | GREEN | 0.165 | 1\50 | 1 |
| 147-69281 | 5207227412684 | 91 x 105 x 23 | 20 | 2400 | GREEN | 0.219 | 1\20 | 1 |
| 147-69282 | 5207227412707 | 120 x 140 x 31 | 30 | 3600 | BLUE | 0.350 | 1\20 | 1 |



• Συμπεριλαμβάνεται τηλεχειριστήριο/
Include Remote control
(Dims1156*35*108mm²)

• Solar Panel Size: 210*200*17mm
• Solar Panel: 5V 6W

• Bat Disc: 10-12h
• Bat Charg: 5-8h
• Bat Type: Lithium: 3.2V 5Ah

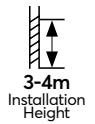
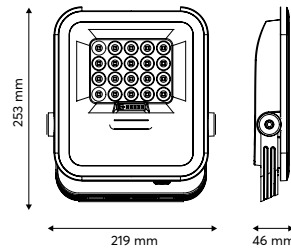

● Μαύρο/Black

50W SMD Ηλιακός - Solar

30.000h

ON OFF
15.000

IP65

IK07

CE



LED Type SMD5050 • Chip Brand Bridgelux • Volt 32V
Start Time 0.5 sec • Operating Temperature -25°C / +45°C
Material Αλουμίνιο - Γυαλί / Aluminium - Glass

| | | | | |
|--------------|------------------|-------------------|----------|------------------------|
| LUMEN 500 | CRI Ra >70 | BEAM ANGLE 90° | DIMMABLE | 2 YEARS WARRANTY |
|--------------|------------------|-------------------|----------|------------------------|

| Code | Barcode | Dimension (mm) ↗ ↔ ↘ | Watt | Kelvin | Weight (kg) | Packing | MOQ |
|-----------|---------------|-------------------------|------|--------|--------------------------------|---------|-----|
| 147-69570 | 5207227288715 | 46 x 219 x 253 | 50 | 4000 | Panel: 0.500. Projector: 0.880 | 1\10 | 1 |

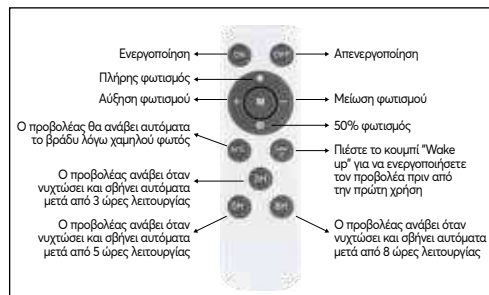

• Συμπεριλαμβάνεται τηλεχειριστήριο/
Include Remote control
(Dims1156*35*108mm²)

• Solar Panel Size: 300*205*17mm²
• Solar Panel: 5V 10W

• Bat Disc: 10-12h
• Bat Charg: 5-8h
• Bat Type: Lithium: 3.2V 10Ah

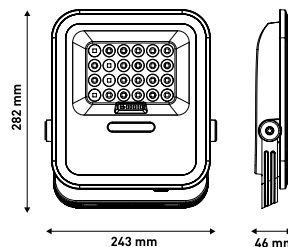

● Μαύρο/Black

100W SMD Ηλιακός - Solar

30.000h

ON OFF
15.000

IP65

IK07

CE



LED Type SMD5050 • Chip Brand Bridgelux • Volt 32V
Start Time 0.5 sec • Operating Temperature -25°C / +45°C
Material Αλουμίνιο - Γυαλί / Aluminium - Glass

| | | | | |
|---------------|------------------|-------------------|----------|------------------------|
| LUMEN 1000 | CRI Ra >70 | BEAM ANGLE 90° | DIMMABLE | 2 YEARS WARRANTY |
|---------------|------------------|-------------------|----------|------------------------|

| Code | Barcode | Dimension (mm) ↗ ↔ ↘ | Watt | Kelvin | Weight (kg) | Packing | MOQ |
|-----------|---------------|-------------------------|------|--------|--------------------------------|---------|-----|
| 147-69571 | 5207227288739 | 46 x 243 x 282 | 100 | 4000 | Panel: 0.720. Projector: 1.140 | 1\5 | 1 |

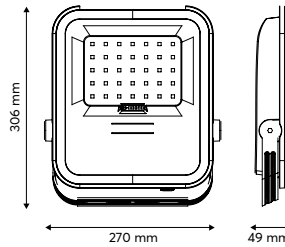

• Συμπεριλαμβάνεται τηλεχειριστήριο/
Include Remote control
(Dims1156*35*108mm²)

• Solar Panel Size: 390*375*17mm²
• Solar Panel: 5V 25W

• Bat Disc: 10-12h
• Bat Charg: 5-8h
• Bat Type: Lithium: 3.2V 25Ah

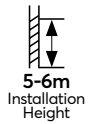

● Μαύρο/Black

200W SMD Ηλιακός - Solar

30.000h

ON OFF
15.000

IP65

IK07

CE



LED Type SMD5050 • Chip Brand Bridgelux • Volt 32V
Start Time 0.5 sec • Operating Temperature -25°C / +45°C
Material Αλουμίνιο - Γυαλί / Aluminium - Glass

| | | | | |
|---------------|------------------|-------------------|----------|------------------------|
| LUMEN 2000 | CRI Ra >70 | BEAM ANGLE 90° | DIMMABLE | 2 YEARS WARRANTY |
|---------------|------------------|-------------------|----------|------------------------|

| Code | Barcode | Dimension (mm) ↕ ↔ ↕ | Watt | Kelvin | Weight (kg) | Packing | MOQ |
|-----------|---------------|-------------------------|------|--------|--------------------------------|---------|-----|
| 147-69572 | 5207227301476 | 49 x 270 x 306 | 200 | 4000 | Panel: 1.000. Projector: 1.340 | 1\5 | 1 |

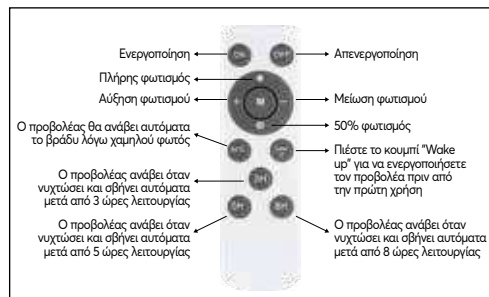

• Συμπεριλαμβάνεται τηλεχειριστήριο/
Include Remote control
(Dims1156*35*108mm²)

• Solar Panel Size: 390*450*17mm²
• Solar Panel: 5V 30W

• Bat Disc: 10-12h
• Bat Charg: 5-8h
• Bat Type: Lithium: 3.2V 25Ah



● Μαύρο/Black

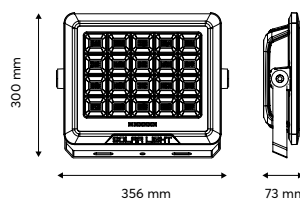

300W SMD Ηλιακός - Solar

30.000h

ON OFF
15.000

IP65

IK07

CE



LED Type SMD5050 • Chip Brand Bridgelux • Volt 32V
Start Time 0.5 sec • Operating Temperature -25°C / +45°C
Material Αλουμίνιο - Γυαλί / Aluminium - Glass

| | | | | |
|---------------|------------------|-------------------|----------|------------------------|
| LUMEN 3000 | CRI Ra >70 | BEAM ANGLE 90° | DIMMABLE | 2 YEARS WARRANTY |
|---------------|------------------|-------------------|----------|------------------------|

| Code | Barcode | Dimension (mm) ↕ ↔ ↕ | Watt | Kelvin | Weight (kg) | Packing | MOQ |
|-----------|---------------|-------------------------|------|--------|--------------------------------|---------|-----|
| 147-69573 | 5207227301490 | 73 x 300 x 356 | 300 | 4000 | Panel: 1.400. Projector: 2.100 | 1\4 | 1 |

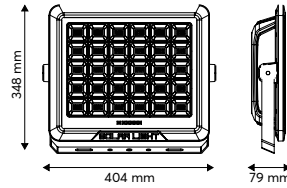

● Μαύρο/Black

400W SMD Ηλιακός - Solar



LED Type SMD5050 • Chip Brand Bridgelux • Volt 32V
Start Time 0.5 sec • Operating Temperature -25°C / +45°C
Material Αλουμίνιο - Γυαλί / Aluminium - Glass

| | | | | |
|----------------------|-------------------------|--------------------------|-----------------|-------------------------------|
| LUMEN 4000 | CRI Ra >70 | BEAM ANGLE 90° | DIMMABLE | 2 YEARS WARRANTY |
|----------------------|-------------------------|--------------------------|-----------------|-------------------------------|

| Code | Barcode | Dimension (mm) ↕ ↔ ↕ | Watt | Kelvin | Weight (kg) | Packing | MOQ |
|-----------|---------------|-------------------------|------|--------|--------------------------------|---------|-----|
| 147-69574 | 5207227301513 | 79 x 348 x 404 | 400 | 4000 | Panel: 1.800. Projector: 2.800 | 1\2 | 1 |

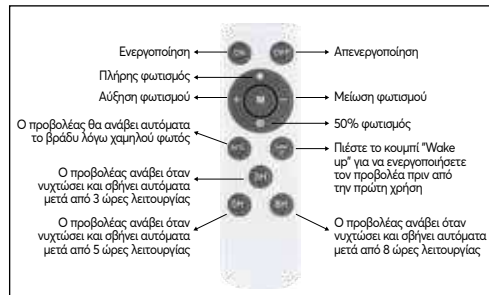

• Συμπεριλαμβάνεται τηλεχειριστήριο/
Include Remote control
(Dims1156*35*108mm²)

• Solar Panel Size: 390*590*20mm²
• Solar Panel: 5V 50W

• Bat Disc: 10-12h
• Bat Charg: 5-8h

• Bat Type: Lithium: 3.2V 40Ah

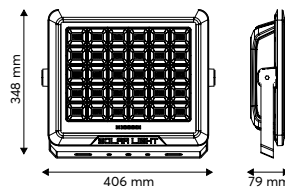

● Μαύρο/Black

500W SMD Ηλιακός - Solar



LED Type SMD5050 • Chip Brand Bridgelux • Volt 32V
Start Time 0.5 sec • Operating Temperature -25°C / +45°C
Material Αλουμίνιο - Γυαλί / Aluminium - Glass

| | | | | |
|----------------------|-------------------------|--------------------------|-----------------|-------------------------------|
| LUMEN 5000 | CRI Ra >70 | BEAM ANGLE 90° | DIMMABLE | 2 YEARS WARRANTY |
|----------------------|-------------------------|--------------------------|-----------------|-------------------------------|

| Code | Barcode | Dimension (mm) ↕ ↔ ↕ | Watt | Kelvin | Weight (kg) | Packing | MOQ |
|-----------|---------------|-------------------------|------|--------|--------------------------------|---------|-----|
| 147-69575 | 5207227288753 | 79 x 348 x 406 | 500 | 4000 | Panel: 2.200. Projector: 3.100 | 1\2 | 1 |



- Camera: 200million pixels 1080P Day & Night / 32GB Card
- Panel: 5V 20W
- Solar panel size: 350x350x17mm²
- Bat Disc: 10-12h
- Bat Charg: 5-8h
- Bat Type: Lithium: 3.2V 18Ah



● Μαύρο/Black

100W SMD Ηλιακός με Κάμερα - Solar with Camera



LED Type SMD2835 • Chip Brand Sanan • Volt 5V
Start Time 0.5 sec • Operating Temperature -25°C / +45°C
Material Αλουμίνιο - Γυαλί / Aluminium - Glass

| | | | | |
|--------------|------------|-------------------|-----------------|-------------------------|
| LUMEN | CRI | BEAM ANGLE | DIMMABLE | 2 YEARS WARRANTY |
| 7300 | >80 | 90° | DIMMABLE | 2 |

| Code | Barcode | Dimension (mm) | | | Watt | Kelvin | Weight (kg) | Packing | MOQ |
|-----------|---------------|----------------|-----|----|------|--------|--------------------------------|---------|-----|
| | | ↗ | ↔ | ↕ | | | | | |
| 147-69594 | 5207227116735 | 179 | 217 | 45 | 100 | 6500 | Panel: 0.800. Projector: 1.250 | 1\8 | 1 |

- Αισθητήρας Μικροκυμάτων/ Microwave Sensor
- Sensor Working Time: 10sec - 8min
- Απόσταση Ανίχνευσης / Detection Distance 6-8m

- Πάνελ 6V 9W με Αισθητήρα Κίνησης / Panel: 5V 25W with Sensor Movement

- Solar panel size: 360x400x20mm²

- Bat Disc: 10-12h
- Bat Charg: 4-5h
- Bat Type: Lithium: 3.2V 15Ah



● Μαύρο/Black

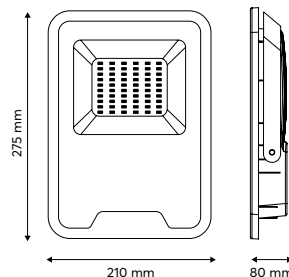

30W SMD Ηλιακός με Ανιχνευτή Κίνησης - Solar with Motion Detector



LED Type SMD5730 • Chip Brand Philips • Volt 5V
Start Time 0.5 sec • Operating Temperature -25°C / +45°C
Material Αλουμίνιο - Γυαλί / Aluminium - Glass

| | | | | |
|--------------|------------|-------------------|-----------------|-------------------------|
| LUMEN | CRI | BEAM ANGLE | DIMMABLE | 2 YEARS WARRANTY |
| 1650 | >80 | 120° | NON DIMMABLE | 2 |

| Code | Barcode | Dimension (mm) | | | Watt | Kelvin | Weight (kg) | Packing | MOQ |
|-----------|---------------|----------------|----|-----|------|--------|--------------------------------|---------|-----|
| | | ↗ | ↔ | ↕ | | | | | |
| 147-69593 | 5207227068836 | 275 | 80 | 210 | 30 | 6500 | Panel: 2.600. Projector: 2.000 | 1\5 | 1 |



146-69020
146-69021
146-69022

146-69023
146-69024
146-69025

146-69026
146-69027
146-69028

146-69029
146-69030
146-69031



• Διαθέτει 5kV αντικεραυνική λειτουργία/
Equiped with 5kV lightning protection function



ZH Driver
LED Driver

● Μαύρο/Black

Modular SMD 200W-600W



LED Type SMD3030 • Chip Brand Sanan • Volt 120-277V 50/60Hz
Start Time 0.5 sec • PF >0.95 • Operating Temperature -20°C / +45°C
Connection Καλώδιο / Wire • Material Αλουμίνιο-Πλαστικό/ Aluminium-Plastic

LUMEN / WATT
lm/W
140

CRI
Ra
>70

BEAM ANGLE
60°

NON DIMMABLE

5 YEARS WARRANTY

| Code | Barcode | Dimension (mm) ↕ ↔ ↕ | Watt | Total Lumen | Kelvin | Weight (kg) | Packing | MOQ |
|-----------|---------------|-------------------------|------|-------------|--------|-------------|---------|-----|
| 146-69020 | 5207227456473 | 416 x 310 x 25 | 200 | 28000 | 6500 | 3.800 | 1 | 1 |
| 146-69021 | 5207227456480 | 416 x 310 x 25 | 200 | 28000 | 5000 | 3.800 | 1 | 1 |
| 146-69022 | 5207227456497 | 416 x 310 x 25 | 200 | 28000 | 4000 | 3.800 | 1 | 1 |
| 146-69023 | 5207227456503 | 614 x 310 x 25 | 300 | 42000 | 6500 | 5.200 | 1 | 1 |
| 146-69024 | 5207227456510 | 614 x 310 x 25 | 300 | 42000 | 5000 | 5.200 | 1 | 1 |
| 146-69025 | 5207227456527 | 614 x 310 x 25 | 300 | 42000 | 4000 | 5.200 | 1 | 1 |
| 146-69026 | 5207227456534 | 590 x 420 x 35 | 400 | 56000 | 6500 | 7.600 | 1 | 1 |
| 146-69027 | 5207227456541 | 590 x 420 x 35 | 400 | 56000 | 5000 | 7.600 | 1 | 1 |
| 146-69028 | 5207227456558 | 590 x 420 x 35 | 400 | 56000 | 4000 | 7.600 | 1 | 1 |
| 146-69029 | 5207227456565 | 620 x 590 x 35 | 600 | 84000 | 6500 | 10.200 | 1 | 1 |
| 146-69030 | 5207227456572 | 620 x 590 x 35 | 600 | 84000 | 5000 | 10.200 | 1 | 1 |
| 146-69031 | 5207227456589 | 620 x 590 x 35 | 600 | 84000 | 4000 | 10.200 | 1 | 1 |



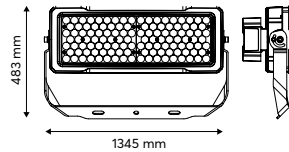

Η βάση δεν συμπεριλαμβάνεται / The base is not included.



Sosen
LED Driver

● Μαύρο/Black

**SMD 250W - 1000W
& Εξαρτήματα - & Accessories**



LED Type SMD2835 • Chip Brand Lumileds • Volt 100-305V 50/60Hz
Start Time 0.5 sec • PF >0.98 • Operating Temperature -30°C / +50°C
Connection Καλώδιο / Wire • Material Αλουμίνιο-Πλαστικό/ Aluminium-Plastic

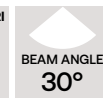

| Code | Barcode | Dimension (mm) | | | Watt | Amperage mA | Kelvin | Weight (kg) | Packing | MOQ |
|-----------|---------------|----------------|------|------|------|----------------------|--------|-------------|---------|-----|
| | | ↕ | ↔ | ↕ | | | | | | |
| 146-69100 | 5207227035319 | 483 | 1345 | 1345 | 250 | 115V/2.2A, 230V/1.1A | 5700 | 5.960 | 1 | 1 |
| 146-69101 | 5207227035326 | 483 | 1345 | 1345 | 250 | 115V/2.2A, 230V/1.1A | 4000 | 5.960 | 1 | 1 |



| Code | Barcode | Dimension (mm) | | | Watt | Amperage mA | Kelvin | Weight (kg) | Packing | MOQ |
|-----------|---------------|----------------|------|------|------|----------------------|--------|-------------|---------|-----|
| | | ↕ | ↔ | ↕ | | | | | | |
| 146-69103 | 5207227328503 | 483 | 1345 | 1345 | 250 | 115V/2.2A, 230V/1.1A | 5700 | 5.960 | 1 | 1 |
| 146-69104 | 5207227199301 | 483 | 1345 | 1345 | 250 | 115V/2.2A, 230V/1.1A | 4000 | 5.960 | 1 | 1 |



● Μαύρο/Black

Βάση Προβολέα Modular - Bracket Arms for Modular



Material Αλουμίνιο / Aluminium



| Code | Barcode | Type | Dimension (mm) | | | Weight (kg) | Packing | MOQ |
|-----------|---------------|-----------|----------------|-----|------|-------------|---------|-----|
| | | | ↕ | ↔ | ↕ | | | |
| 146-69110 | 5207227035333 | SINGLE | 483 | 134 | 296 | 1,00 | 1\15 | 1 |
| 146-69111 | 5207227035340 | DOUBLE | 510 | 136 | 563 | 7.200 | 1 | 1 |
| 146-69112 | 5207227035357 | TRIPLE | 510 | 136 | 764 | 8.900 | 1 | 1 |
| 146-69113 | 5207227035364 | QUADRUPLE | 510 | 136 | 965 | 13.650 | 1 | 1 |
| 146-69114 | 5207227124242 | FIVEFOLD | 510 | 136 | 1145 | 14.000 | 1 | 1 |



● Μαύρο/Black

⚡ CLASS I CE

Για Πάρκινγκ Τετραπλή Lumosa Tiny
For Parking Quad Lumosa Tiny

Material Αλουμίνιο / Aluminium



| Code | Barcode | Dimension (mm) ↕ ↔ ↕ | Weight (kg) | Packing | MOQ |
|-----------|---------------|-------------------------|-------------|---------|-----|
| 146-69115 | 5207227035371 | 545 x 289 x 78 | 8.000 | 1 | 1 |

| Code | Barcode | Dimension Ø (mm) ↕ | Weight (kg) | Packing | MOQ |
|-----------|---------------|-----------------------|-------------|---------|-----|
| 146-69116 | 5207227035388 | 512 x 123 | 6.000 | 1 | 1 |



Μπαταρία 16340/Battery 16340

● Μαύρο/Black

⚡ CLASS I CE

Λέιζερ Ρυθμίσηση Προβολέα - Laser Headlight Alignment

Volt 3.7V

Operating Temperature -10°C / +50°C

Material Αλουμίνιο/Aluminium



| Code | Barcode | Dimension Ø (mm) ↕ | Weight (kg) | Packing | MOQ |
|-----------|---------------|-----------------------|-------------|---------|-----|
| 146-69117 | 5207227035395 | 25 x 120 | 0.230 | 1 | 1 |





Sosen
LED Driver

Λευκό/White

Φωτιστικό Χωνευτό LED SMD 40x40cm
Recessed LED SMD Light 40x40cm



LED Type SMD3030 • Chip Brand Lumileds • Volt 100-240V 50/60Hz
Start Time 1 sec • PF >0.92 • Operating Temperature -30°C / +50°C
Connection Καλώδιο / Wire • Material Πλαστικό-Μεταλλικό/ Plastic-Metallic

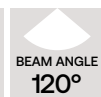

| Code | Barcode | Dimension (mm) ↕ ↔ ↕ | Watt | Amperage mA | Kelvin | Weight (kg) | Packing | MOQ |
|-----------|---------------|-------------------------|------|----------------|--------|----------------|---------|-----|
| 147-56321 | 5207227059155 | 400 x 400 x 76 | 75 | 1.44 | 5000 | 2.400 | 1 | 1 |



• Αισθητήρας Μικροκυμάτων/ Microwave Sensor

• Όταν ανιχνευθεί κίνηση, αλλά το φως της ημέρας είναι επαρκές, το φως παραμένει σβηστό /
When motion detected, but sufficient daylight, light remains OFF

• Όταν ανιχνευθεί κίνηση σε ανεπαρκές φως ημέρας, το φως ανάβει /
When motion detected, insufficient daylight, light ON

• Μετά την τελευταία ανίχνευση, το φως θα μεταβαίνει στο επίπεδο που έχει ρυθμιστεί (10%, 20%, 30%, 50%) /
After last detection, the light will be dimm'ed down to the stand-by dimm'ing level (10%, 20%, 30%, 50%)

Γκρι/Grey

Φωτιστικό Χωνευτό LED SMD 40x40cm
Recessed LED SMD Light 40x40cm



Volt 220-240V 50/60Hz
Start Time 0.5 sec • PF >0.92 • Operating Temperature -35°C / +70°C
Connection Καλώδιο / Wire • Material Πλαστικό-Μεταλλικό/ Plastic-Metallic

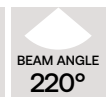
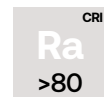

| Code | Barcode | Dimension Ø (mm) ↕ | Weight (kg) | Packing | MOQ |
|-----------|---------------|-----------------------|----------------|---------|-----|
| 147-56322 | 5207227059162 | 80 x 70 | 0.300 | 1 | 1 |





Φωτιστικά
Δρόμου LED

Street LED Lights



- Διαθέτει 4-8kV αντικεραυνική λειτουργία / Equipped with 4-8kV lightning protection function
- Ρυθμιζόμενη κλίση για τοποθέτηση σε ιστό ή βραχίονα Ø60mm² / Adjustable angle for mast or arm mounting Ø60mm²

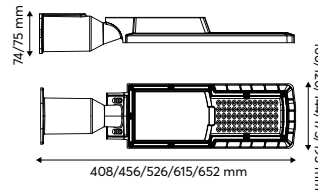

Γκρι/Grey

120L/W 30W-200W

35000h
 ON OFF 50.000
 IP66
 CLASS I
 IK07
 CE
 E



LED Type SMD2835 • Chip Brand Sanan • Volt 160-265V 50/60Hz
 Start Time 0.5 sec • PF >0.90 • Operating Temperature -20°C / +50°C
 Connection Καλώδιο / Wire • Material Αλουμίνιο-Πλαστικό/ Aluminium-Plastic

LUMEN / WATT 120
 CRI Ra >80
 BEAM ANGLE 120°
 NON DIMMABLE
 5 YEARS WARRANTY

| Code | Barcode | Dimension (mm) | | | Watt | Total Lumen | Kelvin | Weight (kg) | Packing | MOQ |
|-----------|---------------|----------------|----|-----|------|-------------|--------|-------------|---------|-----|
| | | ↗ | ↔ | ↘ | | | | | | |
| 146-57160 | 5207227456411 | 106 | 74 | 408 | 30 | 3600 | 6500 | 0.580 | 1/10 | 1 |
| 146-57161 | 5207227426087 | 106 | 74 | 408 | 30 | 3600 | 4000 | 0.580 | 1/10 | 1 |
| 146-57162 | 5207227456428 | 106 | 74 | 408 | 30 | 3600 | 3000 | 0.580 | 1/10 | 1 |
| 146-57163 | 5207227426100 | 120 | 74 | 456 | 50 | 6000 | 6500 | 0.781 | 1/10 | 1 |
| 146-57164 | 5207227426124 | 120 | 74 | 456 | 50 | 6000 | 4000 | 0.781 | 1/10 | 1 |
| 146-57165 | 5207227456435 | 120 | 74 | 456 | 50 | 6000 | 3000 | 0.781 | 1/10 | 1 |
| 146-57166 | 5207227426148 | 144 | 74 | 526 | 70 | 8400 | 6500 | 1.027 | 1/10 | 1 |
| 146-57167 | 5207227426162 | 144 | 74 | 526 | 70 | 8400 | 4000 | 1.027 | 1/10 | 1 |
| 146-57168 | 5207227456442 | 144 | 74 | 526 | 70 | 8400 | 3000 | 1.027 | 1/10 | 1 |
| 146-57169 | 5207227426186 | 144 | 74 | 526 | 100 | 12000 | 6500 | 1.027 | 1/10 | 1 |
| 146-57170 | 5207227426209 | 144 | 74 | 526 | 100 | 12000 | 4000 | 1.027 | 1/10 | 1 |
| 146-57171 | 5207227426223 | 144 | 74 | 526 | 100 | 12000 | 3000 | 1.027 | 1/10 | 1 |
| 146-57172 | 5207227426247 | 175 | 75 | 615 | 150 | 18000 | 6500 | 1.484 | 1/10 | 1 |
| 146-57173 | 5207227426261 | 175 | 75 | 615 | 150 | 18000 | 4000 | 1.484 | 1/10 | 1 |
| 146-57174 | 5207227456459 | 175 | 75 | 615 | 150 | 18000 | 3000 | 1.484 | 1/10 | 1 |
| 146-57175 | 5207227426285 | 193 | 75 | 652 | 200 | 24000 | 6500 | 1.731 | 1/10 | 1 |
| 146-57176 | 5207227426308 | 193 | 75 | 652 | 200 | 24000 | 4000 | 1.731 | 1/10 | 1 |
| 146-57177 | 5207227456466 | 193 | 75 | 652 | 200 | 24000 | 3000 | 1.731 | 1/10 | 1 |



ΦΩΤΙΣΜΟΣ - PROFESSIONAL LIGHTING

• Οπή Σύνδεσης / Connection Hole:
 Ø42mm² (30-90W) & Ø60mm² (120-150W)

• Διαθέτει 4-8kV αντικεραυνική λειτουργία /
 Equipped with 4-8kV lightning protection function

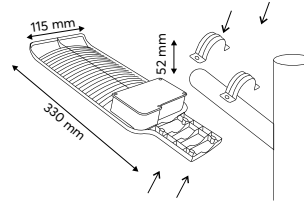

6-10m
Installation
Height

SHNG
LED Driver

● Γκρι/Grey

140L/W 30W-150W



LED Type SMD2835 • Chip Brand Epistar • Volt 85-265V 50/60Hz
 Start Time 0.5 sec • PF >0.90 • Operating Temperature -40°C / +50°C
 Connection Καλώδιο / Wire • Material Αλουμίνιο-Πλαστικό/ Aluminium-Plastic

LUMEN / WATT
lm/W
140

CRI
Ra >80

BEAM ANGLE
120°

NON DIMMABLE

3
YEARS
WARRANTY

| Code | Barcode | Dimension (mm) | | | Watt | Total Lumen | Kelvin | Weight (kg) | Packing | MOQ |
|-----------|---------------|----------------|-----|----|------|-------------|--------|-------------|---------|-----|
| | | ↔ | ↕ | ↔ | | | | | | |
| 146-57030 | 5207227073533 | 330 | 115 | 52 | 30 | 4200 | 6500 | 0.650 | 1/10 | 1 |
| 146-57031 | 5207227073540 | 330 | 115 | 52 | 30 | 4200 | 4000 | 0.650 | 1/10 | 1 |
| 146-57032 | 5207227073557 | 330 | 115 | 52 | 30 | 4200 | 3000 | 0.650 | 1/10 | 1 |
| 146-57033 | 5207227073564 | 350 | 115 | 52 | 40 | 5600 | 6500 | 0.650 | 1/10 | 1 |
| 146-57034 | 5207227073571 | 350 | 115 | 52 | 40 | 5600 | 4000 | 0.650 | 1/10 | 1 |
| 146-57035 | 5207227073588 | 350 | 115 | 52 | 40 | 5600 | 3000 | 0.650 | 1/10 | 1 |
| 146-57036 | 5207227073595 | 430 | 150 | 62 | 60 | 8400 | 6500 | 1.050 | 1/10 | 1 |
| 146-57037 | 5207227073601 | 430 | 150 | 62 | 60 | 8400 | 4000 | 1.050 | 1/10 | 1 |
| 146-57038 | 5207227073618 | 430 | 150 | 62 | 60 | 8400 | 3000 | 1.050 | 1/10 | 1 |
| 146-57039 | 5207227073625 | 450 | 150 | 62 | 90 | 12600 | 6500 | 1.150 | 1/10 | 1 |
| 146-57040 | 5207227073632 | 450 | 150 | 62 | 90 | 12600 | 4000 | 1.150 | 1/10 | 1 |
| 146-57041 | 5207227073649 | 450 | 150 | 62 | 90 | 12600 | 3000 | 1.150 | 1/10 | 1 |
| 146-57042 | 5207227073656 | 565 | 180 | 72 | 120 | 16800 | 6500 | 1.500 | 1\6 | 1 |
| 146-57043 | 5207227073663 | 565 | 180 | 72 | 120 | 16800 | 4000 | 1.500 | 1\6 | 1 |
| 146-57044 | 5207227073670 | 565 | 180 | 72 | 120 | 16800 | 3000 | 1.500 | 1\6 | 1 |
| 146-57045 | 5207227073687 | 590 | 180 | 72 | 150 | 21000 | 6500 | 1.850 | 1\6 | 1 |
| 146-57046 | 5207227073694 | 590 | 180 | 72 | 150 | 21000 | 4000 | 1.850 | 1\6 | 1 |
| 146-57047 | 5207227073700 | 590 | 180 | 72 | 150 | 21000 | 3000 | 1.850 | 1\6 | 1 |





160L/W 20W-30W

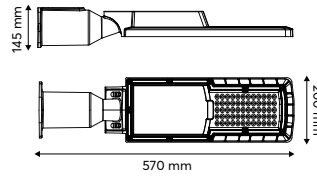

Sosen
LED Driver

Γκρι/Grey



• Οπή Σύνδεσης / Connection Hole: Ø60mm²

• Διαθέτει 10kV αντικεραυνική λειτουργία/
10kV lightning protection function

• Ρυθμιζόμενη κλίση για τοποθέτηση σε ιστό ή βραχίονα/
Adjustable angle for mast or arm mounting

LED Type SMD2835 • Chip Brand Lumileds • Volt 100-277V 50/60Hz
Start Time 0.5 sec • PF >0.90 • Operating Temperature -40°C / +50°C
Connection Καλώδιο / Wire • Material Αλουμίνιο-Πλαστικό/ Aluminium-Plastic

| | | | | |
|------------------------------------|-------------------------|---------------------------|--------------|----------------------------|
| LUMEN / WATT lm/W 160 | CRI Ra >70 | BEAM ANGLE 120° | NON DIMMABLE | 5 YEARS WARRANTY |
|------------------------------------|-------------------------|---------------------------|--------------|----------------------------|

| Code | Barcode | Dimension (mm) | | | Watt | Total Lumen | Kelvin | Weight (kg) | Packing | MOQ |
|-----------|---------------|----------------|-----|-----|------|-------------|--------|-------------|---------|-----|
| | | ↗ | ↔ | ↕ | | | | | | |
| 146-57050 | 5207227301711 | 570 | 200 | 145 | 20 | 3200 | 6500 | 1.200 | 1 | 1 |
| 146-57051 | 5207227301780 | 570 | 200 | 145 | 20 | 3200 | 4000 | 1.200 | 1 | 1 |
| 146-57052 | 5207227301766 | 570 | 200 | 145 | 20 | 3200 | 3000 | 1.200 | 1 | 1 |
| 146-57053 | 5207227301735 | 570 | 200 | 145 | 30 | 4800 | 6500 | 1.200 | 1 | 1 |
| 146-57054 | 5207227301797 | 570 | 200 | 145 | 30 | 4800 | 4000 | 1.200 | 1 | 1 |
| 146-57055 | 5207227301803 | 570 | 200 | 145 | 30 | 4800 | 3000 | 1.200 | 1 | 1 |

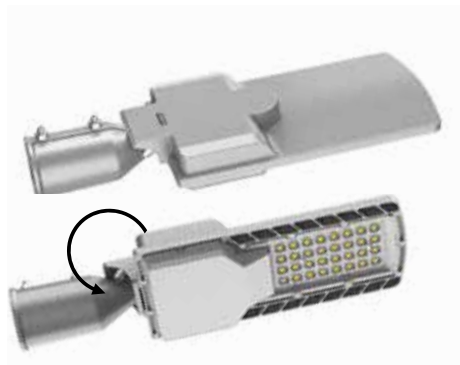

160L/W 40W-50W

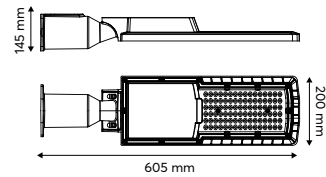

Sosen
LED Driver

Γκρι/Grey



• Διαθέτει 10kV αντικεραυνική λειτουργία /
Equipped with 10kV lightning protection function

• Ρυθμιζόμενη κλίση για τοποθέτηση σε ιστό ή βραχίονα Ø60mm² /
Adjustable angle for mast or arm mounting Ø60mm²

LED Type SMD2835 • Chip Brand Lumileds • Volt 100-277V 50/60Hz
Start Time 0.5 sec • PF >0.90 • Operating Temperature -40°C / +50°C
Connection Καλώδιο / Wire • Material Αλουμίνιο-Πλαστικό/ Aluminium-Plastic

| | | | | |
|------------------------------------|-------------------------|---------------------------|--------------|----------------------------|
| LUMEN / WATT lm/W 160 | CRI Ra >70 | BEAM ANGLE 120° | NON DIMMABLE | 5 YEARS WARRANTY |
|------------------------------------|-------------------------|---------------------------|--------------|----------------------------|

| Code | Barcode | Dimension (mm) | | | Watt | Total Lumen | Kelvin | Weight (kg) | Packing | MOQ |
|-----------|---------------|----------------|-----|-----|------|-------------|--------|-------------|---------|-----|
| | | ↗ | ↔ | ↕ | | | | | | |
| 146-57056 | 5207227301742 | 605 | 200 | 145 | 40 | 6400 | 6500 | 1.320 | 1 | 1 |
| 146-57057 | 5207227301728 | 605 | 200 | 145 | 40 | 6400 | 4000 | 1.320 | 1 | 1 |
| 146-57058 | 5207227301773 | 605 | 200 | 145 | 40 | 6400 | 3000 | 1.320 | 1 | 1 |
| 146-57059 | 5207227301759 | 605 | 200 | 145 | 50 | 8000 | 6500 | 1.320 | 1 | 1 |
| 146-57060 | 5207227301902 | 605 | 200 | 145 | 50 | 8000 | 4000 | 1.320 | 1 | 1 |
| 146-57061 | 5207227301810 | 605 | 200 | 145 | 50 | 8000 | 3000 | 1.320 | 1 | 1 |

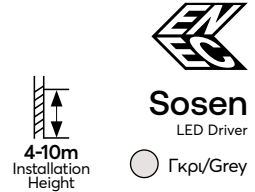
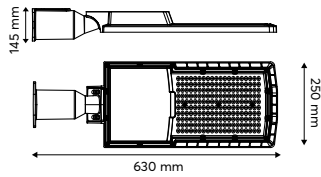
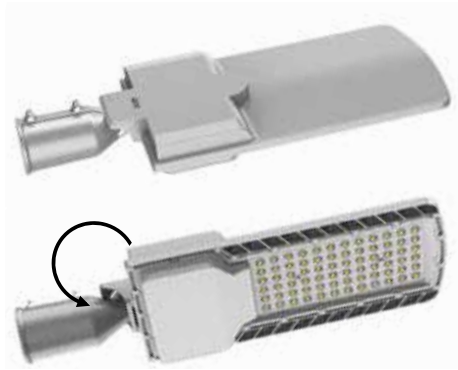

160L/W 80W-100W

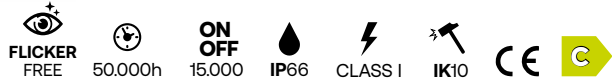

LED Type SMD2835 • Chip Brand Lumileds • Volt 100-277V 50/60Hz
 Start Time 0.5 sec • PF >0.90 • Operating Temperature -40°C / +50°C
 Connection Καλώδιο / Wire • Material Αλουμίνιο-Πλαστικό/ Aluminium-Plastic

| | | | | |
|-----------------------------|------------------|--------------------|--------------|------------------|
| LUMEN / WATT lm/W 160 | CRI Ra >70 | BEAM ANGLE 120° | NON DIMMABLE | 5 YEARS WARRANTY |
|-----------------------------|------------------|--------------------|--------------|------------------|

| Code | Barcode | Dimension (mm) | | | Watt | Total Lumen | Kelvin | Weight (kg) | Packing | MOQ |
|-----------|---------------|----------------|-----|-----|------|-------------|--------|-------------|---------|-----|
| | | ↗ | ↔ | ↘ | | | | | | |
| 146-57062 | 5207227301834 | 630 | 250 | 145 | 80 | 12800 | 6500 | 1.960 | 1 | 1 |
| 146-57063 | 5207227301841 | 630 | 250 | 145 | 80 | 12800 | 4000 | 1.960 | 1 | 1 |
| 146-57064 | 5207227301827 | 630 | 250 | 145 | 80 | 12800 | 3000 | 1.960 | 1 | 1 |
| 146-57065 | 5207227301889 | 630 | 250 | 145 | 100 | 16000 | 6500 | 1.960 | 1 | 1 |
| 146-57066 | 5207227301858 | 630 | 250 | 145 | 100 | 16000 | 4000 | 1.960 | 1 | 1 |
| 146-57067 | 5207227301896 | 630 | 250 | 145 | 100 | 16000 | 3000 | 1.960 | 1 | 1 |

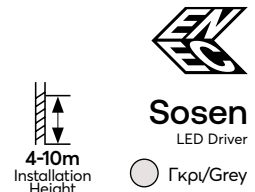
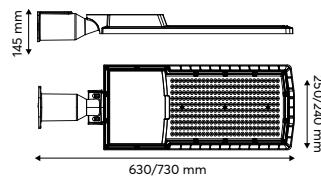
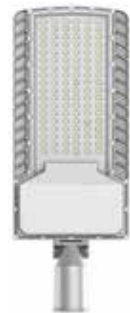
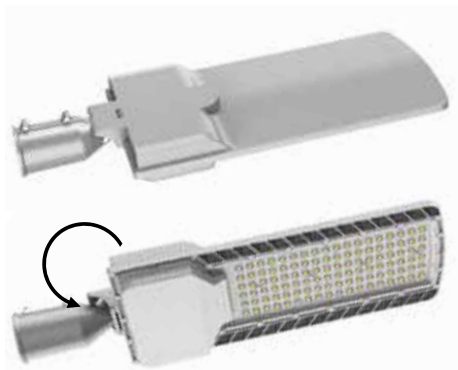

160L/W 120W-150W



LED Type SMD2835 • Chip Brand Lumileds • Volt 100-277V 50/60Hz
 Start Time 0.5 sec • PF >0.90 • Operating Temperature -40°C / +50°C
 Connection Καλώδιο / Wire • Material Αλουμίνιο-Πλαστικό/ Aluminium-Plastic

| | | | | |
|-----------------------------|------------------|--------------------|--------------|------------------|
| LUMEN / WATT lm/W 160 | CRI Ra >70 | BEAM ANGLE 120° | NON DIMMABLE | 5 YEARS WARRANTY |
|-----------------------------|------------------|--------------------|--------------|------------------|

| Code | Barcode | Dimension (mm) | | | Watt | Total Lumen | Kelvin | Weight (kg) | Packing | MOQ |
|-----------|---------------|----------------|-----|-----|------|-------------|--------|-------------|---------|-----|
| | | ↗ | ↔ | ↘ | | | | | | |
| 146-57068 | 5207227301872 | 630 | 250 | 145 | 120 | 19200 | 6500 | 1.960 | 1 | 1 |
| 146-57069 | 5207227301865 | 630 | 250 | 145 | 120 | 19200 | 4000 | 1.960 | 1 | 1 |
| 146-57070 | 5207227301926 | 630 | 250 | 145 | 120 | 19200 | 3000 | 1.960 | 1 | 1 |
| 146-57071 | 5207227301940 | 730 | 240 | 145 | 150 | 24000 | 6500 | 2.400 | 1 | 1 |
| 146-57072 | 5207227301933 | 730 | 240 | 145 | 150 | 24000 | 4000 | 2.400 | 1 | 1 |
| 146-57073 | 5207227301919 | 730 | 240 | 145 | 150 | 24000 | 3000 | 2.400 | 1 | 1 |



- Αισθητήρας Μικροκυμάτων/ Microwave Sensor
- Solar panel: Monocrystalline 5V 18W & Working time: 12H (optional) 2--3 rainy days & Working pattern: light control + remote control + time control. The remote control could dim the light.
- Κατάλληλοι για Βραχίονες / Suitable for Brackets: Ø60mm
- Bat Cap: 15000mAh
- Bat Charg: 6-8h
- Bat Type: LiFePO4 3.2V 15000mAh **Removable**
- Bat Disc: >12h
- Charg Cab: Built-in
- If based on the movement sensor mode, fully bright when someone comes, dimly bright when someone leaves (10%)
- 8-10 sensing distance
- Dim after 10-15 seconds when someone leaves

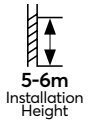

● Γκρι / Grey

LED SMD 20W
Με Ανιχνευτή Κίνησης - With Motion Sensor



LED Type SMD5050 • Chip Brand AMTC • Volt 3.2V DC
Start Time 0.1 sec • Operating Temperature -25°C / +45°C
Material Αλουμίνιο - Γυαλί / Aluminium - Glass

| | | | | |
|----------------------------|-------------------------|------------------------|----------|------------------------|
| LUMEN lm 1600 | CRI Ra >70 | BEAM ANGLE 70°-140° | DIMMABLE | 3 YEARS WARRANTY |
|----------------------------|-------------------------|------------------------|----------|------------------------|

| Code | Barcode | Dimension (mm) | | | Watt | Kelvin | Weight (kg) | Packing | MOQ |
|-----------|---------------|----------------|-----|----|------|--------|-------------|---------|-----|
| | | ↗ | ↔ | ↘ | | | | | |
| 200-57810 | 5207227456619 | 590 | 255 | 75 | 20 | 6000 | 2.780 | 1\6 | 1 |
| 200-57811 | 5207227456626 | 590 | 255 | 75 | 20 | 4000 | 2.780 | 1\6 | 1 |



- Αισθητήρας Μικροκυμάτων/ Microwave Sensor
- Solar panel: Monocrystalline 5V 18W & Working time: 12H (optional) 2--3 rainy days & Working pattern: light control + remote control + time control. The remote control could dim the light.
- Κατάλληλοι για Βραχίονες / Suitable for Brackets: Ø60mm
- Bat Cap: 25000mAh
- Bat Charg: 6-8h
- Bat Type: LiFePO4 3.2V 25000mAh **Removable**
- Bat Disc: >12h
- Charg Cab: Built-in
- If based on the movement sensor mode, fully bright when someone comes, dimly bright when someone leaves (10%)
- 8-10 sensing distance
- Dim after 10-15 seconds when someone leaves



● Γκρι / Grey

LED SMD 30W
Με Ανιχνευτή Κίνησης - With Motion Sensor



LED Type SMD5050 • Chip Brand AMTC • Volt 3.2V DC
Start Time 0.1 sec • Operating Temperature -25°C / +45°C
Material Αλουμίνιο - Γυαλί / Aluminium - Glass

| | | | | |
|----------------------------|-------------------------|------------------------|----------|------------------------|
| LUMEN lm 2900 | CRI Ra >70 | BEAM ANGLE 70°-140° | DIMMABLE | 3 YEARS WARRANTY |
|----------------------------|-------------------------|------------------------|----------|------------------------|

| Code | Barcode | Dimension (mm) | | | Watt | Kelvin | Weight (kg) | Packing | MOQ |
|-----------|---------------|----------------|-----|----|------|--------|-------------|---------|-----|
| | | ↗ | ↔ | ↘ | | | | | |
| 200-57812 | 5207227456633 | 740 | 255 | 75 | 30 | 6000 | 3.690 | 1\4 | 1 |
| 200-57813 | 5207227456640 | 740 | 255 | 75 | 30 | 4000 | 3.690 | 1\4 | 1 |



- Αισθητήρας Μικροκυμάτων/ Microwave Sensor
- 200-57816: "20W/6V monocrystalline silicon solar panel, Control method: light control+remote control+radar sensor."
- 200-57818: "25W/6V monocrystalline silicon solar panel, Control method: light control+remote control+radar sensor."
- Ρυθμιζόμενη κλίση για ιστό ή για βραχίονα Ø60mm²
Adjustable tilt for mast or bracket Ø60mm²

- Bat Cap: 18000mAh / 24000mAh
- Bat Charg: 4-5h
- Bat Type: LiFePO4 3.2V / 18AH / 24AH
- Bat Disc: >12h
- Charg Cab: Built-in

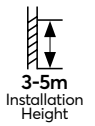

● Γκρι / Grey

LED SMD 17W / 23W Luna Με Ανιχνευτή Κίνησης - With Motion Sensor



LED Type SMD 2835 · Chip Brand Sanan · Volt 6V DC
Start Time 0.1 sec · Operating Temperature -20°C / +45°C
Material Αλουμίνιο - Γυαλί / Aluminium - Glass

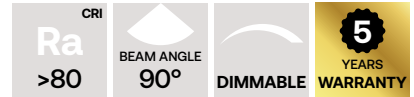

| Code | Barcode | Dimension (mm) | | | Watt | Lumen | Kelvin | Weight (kg) | Packing | MOQ |
|-----------|---------------|----------------|-----|----|------|-------|--------|-------------|---------|-----|
| | | ↔ | ↕ | ↔ | | | | | | |
| 200-57816 | 5207227475085 | 695 | 207 | 95 | 17 | 2200 | 6000 | 3.080 | 1\4 | 1 |
| 200-57818 | 5207227475108 | 808 | 207 | 95 | 23 | 3000 | 6000 | 3.400 | 1\4 | 1 |





○ Λευκό/White



E27



IP23



IK06



Φωτιστικό Καπελάκι Βραχίονος - Street Light

Volt 220-240V 50/60Hz

Start Time 0.5 sec • PF >0.92 • Operating Temperature -20°C / +60°C

Connection Καλώδιο / Wire • Material Αλουμίνιο/Aluminium



BEAM ANGLE
220°



NON
DIMMABLE



2
YEARS
WARRANTY

| Code | Barcode | Dimension (mm) Ø ↔ ↓ | Watt | Weight (kg) | Packing | MOQ |
|-----------|---------------|-------------------------|-------------|-------------|---------|-----|
| 146-57900 | 5207227328954 | 300 x 1000 x 350 | MAX 30W LED | 1.200 | 1 | 1 |
| 146-57901 | 5207227328961 | 300 x 1000 x 350 | MAX 30W LED | 1.200 | 1 | 1 |
| 146-57902 | 5207227328978 | 200 x 1000 x 350 | MAX 30W LED | 1.200 | 1 | 1 |



○ Λευκό-Πράσινο/White-Green



E27



IP23



IK10



Φωτιστικό Καπελάκι Βραχίονος - Street Light

Volt 220-240V 50/60Hz

Start Time 0.5 sec • PF >0.92 • Operating Temperature -20°C / +60°C

Connection Καλώδιο / Wire • Material Αλουμίνιο/Aluminium



BEAM ANGLE
220°



NON
DIMMABLE



2
YEARS
WARRANTY

| Code | Barcode | Dimension (mm) Ø ↔ ↓ | Watt | Weight (kg) | Packing | MOQ |
|-----------|---------------|-------------------------|-------------|-------------|---------|-----|
| 146-57903 | 5207227328985 | 300 x 1000 x 350 | MAX 30W LED | 1.600 | 1 | 1 |





Βραχίονες / Bracket 1-2m Ø42-60 ERIBAN

Γαλβανική Επιμετάλλωση/
Galvanic Plating

Material Μεταλλικό/ Metallic

| Code | Barcode | Dimension (mm) Ø ℓ | Weight (kg) | Packing | MOQ |
|-----------|---------------|--------------------------|----------------|---------|-----|
| 147-22410 | 5206139394101 | 42 x 1100 | 1.500 | 1\5 | 1 |
| 147-22419 | 5207227256400 | 48 x 1100 | 1.500 | 1\5 | 1 |
| 147-22411 | 5207227072352 | 60 x 1100 | 3.500 | 1 | 1 |
| 147-22415 | 5207227123672 | 42 x 2000 | 2.100 | 1\5 | 1 |
| 147-22416 | 5207227123689 | 60 x 2000 | 7.100 | 1 | 1 |



Αντάπτορες Βραχίονα - Bracket Adapters

Γκρι/Grey

Material Αλουμίνιο/Aluminium

| Code | Barcode | Type | Lamp Pole | Dimension Ø (mm) ℓ | Weight (kg) | Packing | MOQ |
|-----------|---------------|------------|-----------|-----------------------|----------------|---------|-----|
| 147-22430 | 5207227330100 | Ø60 to Ø60 | Ø60 | 63 x 264 | 0.8 | 1\16 | 1 |
| 147-22431 | 5207227432316 | Ø50 to Ø60 | Ø50 | 55 x 246 | 0.7 | 1\18 | 1 |
| 147-22432 | 5207227330117 | Ø60 to Ø50 | Ø60 | 63 x 265 | 0.7 | 1\16 | 1 |
| 147-22437 | 5207227432330 | Ø76 to Ø60 | Ø76 | 76 x 314,7 | 1.18 | 1\16 | 1 |
| 147-22434 | 5207227330124 | Ø75 to Ø60 | Ø72 | 75 x 170 | 0.39 | 1\16 | 1 |

• Οπή Σύνδεσης: Ø80mm² / Connection Hole: Ø80mm²



Sosen
LED Driver

● Μαύρο/Black



30W-60W 100-277V AC



LED Type SMD3030 • Chip Brand CREE • Volt 100-277V 50/60Hz
Start Time 0.5 sec • PF >0.95 • Operating Temperature -40°C / +50°C
Connection Καλώδιο / Wire
Material Αλουμίνιο-Πλαστικό-Γυαλί / Aluminium-Plastic-Glass

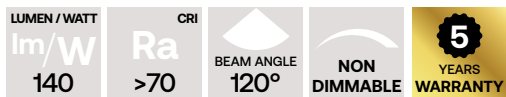

| Code | Barcode | Dimension (mm) ↗ ↔ ↘ | Watt | Total Lumen | Kelvin | Weight (kg) | Packing | MOQ |
|-----------|---------------|-------------------------|------|-------------|--------|-------------|---------|-----|
| 146-58012 | 5207227302176 | 400 x 400 x 701 | 30 | 4200 | 5000 | 7.000 | 1 | 1 |
| 146-58013 | 5207227302183 | 400 x 400 x 701 | 30 | 4200 | 4000 | 7.000 | 1 | 1 |
| 146-58014 | 5207227302145 | 400 x 400 x 701 | 30 | 4200 | 3000 | 7.000 | 1 | 1 |
| 146-58015 | 5207227302121 | 400 x 400 x 701 | 40 | 5600 | 5000 | 7.000 | 1 | 1 |
| 146-58016 | 5207227302190 | 400 x 400 x 701 | 40 | 5600 | 4000 | 7.000 | 1 | 1 |
| 146-58017 | 5207227302169 | 400 x 400 x 701 | 40 | 5600 | 3000 | 7.000 | 1 | 1 |
| 146-58018 | 5207227302138 | 400 x 400 x 701 | 60 | 8400 | 5000 | 7.000 | 1 | 1 |
| 146-58019 | 5207227302152 | 400 x 400 x 701 | 60 | 8400 | 4000 | 7.000 | 1 | 1 |
| 146-58020 | 5207227302206 | 400 x 400 x 701 | 60 | 8400 | 3000 | 7.000 | 1 | 1 |



ΦΩΤΙΣΜΟΣ - PROFESSIONAL LIGHTING

• Οπή Σύνδεσης: Ø80mm² / Connection Hole: Ø80mm²

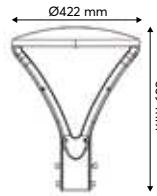

Meanwell
LED Driver

● Μαύρο/Black

30W-90W 100-277V AC



LED Type SMD2835 • Chip Brand Lumileds • Volt 100-277V 50/60Hz
Start Time 0.5 sec • PF >0.95 • Operating Temperature -40°C / +50°C
Connection Καλώδιο / Wire
Material Αλουμίνιο-Πλαστικό-Γυαλί / Aluminium-Plastic-Glass

LUMEN / WATT
lm/W
150

CRI
Ra
>70

BEAM ANGLE
90°

NON DIMMABLE

5 YEARS WARRANTY

| Code | Barcode | Dimension (mm) Ø ↓ | Watt | Total Lumen | Kelvin | Weight (kg) | Packing | MOQ |
|-----------|---------------|-----------------------|------|-------------|--------|-------------|---------|-----|
| 146-58000 | 5207227301988 | 422 x 539 | 30 | 4500 | 5000 | 5.700 | 1 | 1 |
| 146-58001 | 5207227302053 | 422 x 539 | 30 | 4500 | 4000 | 5.700 | 1 | 1 |
| 146-58002 | 5207227301971 | 422 x 539 | 30 | 4500 | 3000 | 5.700 | 1 | 1 |
| 146-58003 | 5207227302015 | 422 x 539 | 40 | 6000 | 5000 | 5.700 | 1 | 1 |
| 146-58004 | 5207227302008 | 422 x 539 | 40 | 6000 | 4000 | 5.700 | 1 | 1 |
| 146-58005 | 5207227302039 | 422 x 539 | 40 | 6000 | 3000 | 5.700 | 1 | 1 |
| 146-58006 | 5207227302022 | 422 x 539 | 60 | 9000 | 5000 | 5.700 | 1 | 1 |
| 146-58007 | 5207227301995 | 422 x 539 | 60 | 9000 | 4000 | 5.700 | 1 | 1 |
| 146-58008 | 5207227302046 | 422 x 539 | 60 | 9000 | 3000 | 5.700 | 1 | 1 |
| 146-58009 | 5207227301964 | 422 x 539 | 90 | 13500 | 5000 | 5.700 | 1 | 1 |
| 146-58010 | 5207227302060 | 422 x 539 | 90 | 13500 | 4000 | 5.700 | 1 | 1 |
| 146-58011 | 5207227302077 | 422 x 539 | 90 | 13500 | 3000 | 5.700 | 1 | 1 |



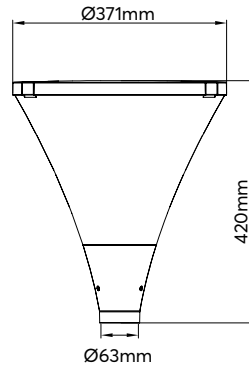

• Οπή Σύνδεσης / Connection Hole: Ø60mm²



Sosen
LED Driver

● Μαύρο/Black

3CCT

(3000K 4000K 5000K)

3CCT 100-277V AC



LED Type SMD3030 • Chip Brand Smalite • Volt 100-240V 50/60Hz
Start Time 1 sec • PF >0.92 • Operating Temperature -30°C / +50°C
Connection Καλώδιο / Wire • Material Αλουμίνιο-Πλαστικό/ Aluminium-Plastic

LUMEN / WATT
lm/W
145

CRI
Ra
>70

BEAM ANGLE
160°

NON DIMMABLE

5
YEARS WARRANTY

| Code | Barcode | Dimension Ø (mm) ϛ | Watt | Total Lumen | Kelvin | Weight (kg) | Packing | MOQ |
|-----------|---------------|--------------------|-------------|-------------|--------|-------------|---------|-----|
| 146-58021 | 5207227301957 | 371 x 420 | 10-20-30-40 | 5800 | 3CCT | 4.600 | 1 | 1 |
| 146-58022 | 5207227269301 | 371 x 420 | 18-30-45-60 | 8700 | 3CCT | 4.600 | 1 | 1 |



ΦΩΤΙΣΜΟΣ - PROFESSIONAL LIGHTING



Καμπάνες LED

High Bay LED

ΦΩΤΙΣΜΟΣ - PROFESSIONAL LIGHTING



Self-made
LED Driver

● Μαύρο/Black

3CCT

(3000K 4000K 6500K)

100-200W 3 wattages option



LED Type SMD2835 • Chip Brand Sanan • Volt 220-240V 50/60Hz
Start Time 0.5 sec • PF >0.90 • Operating Temperature -20°C / +50°C
Connection Καλώδιο / Wire • Material Αλουμίνιο/Aluminium

LUMEN / WATT
lm/W
120

CRI
Ra
>80

BEAM ANGLE
90°

NON
DIMMABLE

3
YEARS
WARRANTY

| Code | Barcode | Dimension Ø (mm) ς | Watt | Total Lumen | Kelvin | Weight (kg) | Packing | MOQ |
|-----------|---------------|-----------------------|-------------|----------------|--------|----------------|---------|-----|
| 145-67150 | 5207227302282 | 230 x 325 | 60-80-100 | 12000 | 3CCT | 0.810 | 1\10 | 1 |
| 145-67151 | 5207227302299 | 272 x 325 | 80-100-150 | 18000 | 3CCT | 1.100 | 1\10 | 1 |
| 145-67152 | 5207227302268 | 314 x 325 | 100-150-200 | 24000 | 3CCT | 1.500 | 1\5 | 1 |



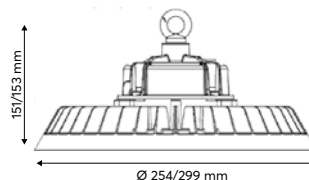

Sosen
LED Driver

● Μαύρο/Black

3CCT

(4000K 5000K 6000K)

160 L/W 3 wattages option



LED Type SMD2835 • Chip Brand Lumileds • Volt 220-240V 50/60Hz
Start Time 0.5 sec • PF >0.90 • Operating Temperature -30°C / +45°C
Connection Καλώδιο / Wire • Material Αλουμίνιο-Πλαστικό/ Aluminium-Plastic

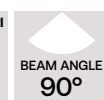
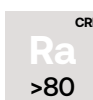

| Code | Barcode | Dimension Ø (mm) ϛ | Watt | Total Lumen | Kelvin | Weight (kg) | Packing | MOQ |
|-----------|---------------|--------------------|-------------|-------------|--------|-------------|---------|-----|
| 145-67123 | 5207227073717 | 254 x 151 | 60-80-100 | 16000 | 3CCT | 2.000 | 1 | 1 |
| 145-67124 | 5207227073724 | 254 x 151 | 80-120-150 | 24000 | 3CCT | 2.100 | 1 | 1 |
| 145-67126 | 5207227073731 | 299 x 153 | 100-150-200 | 32000 | 3CCT | 3.000 | 1 | 1 |

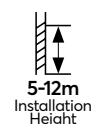
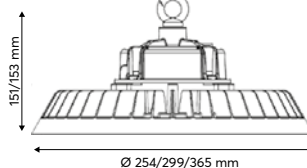

Sosen
LED Driver

● Μαύρο/Black

3CCT

(4000K 5000K 6000K)

200 L/W 3 wattages option



LED Type SMD2835 • Chip Brand Lumileds • Volt 220-240V 50/60Hz
Start Time 0.5 sec • PF >0.90 • Operating Temperature -30°C / +45°C
Connection Καλώδιο / Wire • Material Αλουμίνιο-Πλαστικό/ Aluminium-Plastic

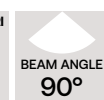
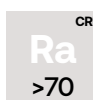

| Code | Barcode | Dimension Ø (mm) ϛ | Watt | Total Lumen | Kelvin | Weight (kg) | Packing | MOQ |
|-----------|---------------|--------------------|-------------|-------------|--------|-------------|---------|-----|
| 145-67130 | 5207227289507 | 254 x 151 | 60-80-100 | 20000 | 3CCT | 1.400 | 1 | 1 |
| 145-67131 | 5207227289514 | 299 x 153 | 80-120-150 | 30000 | 3CCT | 1.800 | 1 | 1 |
| 145-67132 | 5207227289521 | 365 x 153 | 100-150-200 | 40000 | 3CCT | 2.300 | 1 | 1 |

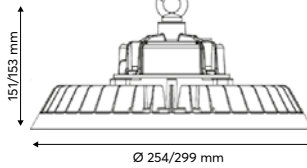

Sosen
LED Driver

● Μαύρο/Black

160L/W - 180 L/W



LED Type SMD2835 • Chip Brand Lumileds • Volt 220-240V 50/60Hz
Start Time 0.5 sec • PF >0.90 • Operating Temperature -30°C / +45°C
Connection Καλώδιο / Wire • Material Αλουμίνιο-Πλαστικό/ Aluminium-Plastic

CRI **Ra >80** BEAM ANGLE **90°** NON DIMMABLE * 0-10V DC DIMMABLE **5 YEARS WARRANTY**

| Code | Barcode | Dimension Ø (mm) ↕ | Watt | Total Lumen | Kelvin | Lumen/Watt | Weight (kg) | Installation Height | Packing | MOQ |
|------------|---------------|--------------------|-------------|-------------|--------|------------|-------------|---------------------|---------|-----|
| 145-67135 | 5207227289477 | 254 x 151 | 100 | 18000 | 4000 | 180 | 1.600 | 5-7m | 1 | 1 |
| 145-67136 | 5207227289491 | 299 x 153 | 200 | 36000 | 4000 | 180 | 1.900 | 10-12m | 1 | 1 |
| 145-67138* | 5207227292217 | 365 x 153 | 100-150-200 | 32000 | 4000 | 160 | 3.100 | 8-10m | 1 | 1 |

Συμβατό με όλες τις καμπάνες χωρίς αισθητήρα κίνησης
Compatible with all bell lights without motion sensor



○ Γκρι/Grey

Kit Μπαταρίας - Emergency Battery Set



Volt 100-240V 50/60Hz • Bat Type Li-ion
Start Time 0.5 sec • Operating Temperature -35°C / +70°C
Connection Καλώδιο / Wire • Material Πλαστικό-Μεταλλικό/ Plastic-Metallic



| Code | Barcode | Dimension (mm) ↕ ↔ ↕ | Amperage mA | Weight (kg) | Packing | MOQ |
|-----------|---------------|----------------------|-------------|-------------|---------|-----|
| 145-67146 | 5207227327650 | 280 x 166 x 100 | 200 | 1.500 | 1\50 | 1 |

Εξαρτήματα Καμπάνας για κωδικό 145-67138 - Accessories for code 145-67138



145-67143

Βάση Οροφής για Καμπάνα
Ceiling Base For High Bay

Material Αλουμίνιο / Aluminium



• Συνιστώνται 2 μπαταρίες 3A/
Recommended 2 batteries 3A

145-67144

Τηλεχειριστήριο με Ανιχνευτή Κίνησης
Remote Control with Movement Sensor

Material Πλαστικό / Plastic



145-67145

Ανιχνευτής Κίνησης
Motion Detector

Volt 5-24V DC 58GHz/75MHz
Material Πλαστικό / Plastic
Beam Angle 360°



| Code | Barcode | Dimension (mm) ↕ ↔ ↕ | Amperage mA | Weight (kg) | Packing | MOQ |
|-----------|---------------|----------------------|-------------|-------------|---------|-----|
| 145-67143 | 5207227299254 | | | 0.400 | 1 | 1 |
| 145-67144 | 5207227299261 | 116.5 x 55 x 13 | | 0.050 | 1 | 1 |
| 145-67145 | 5207227299278 | Ø 48 x 20 | 33 | 0.108 | 1 | 1 |



Moso
LED Driver

 Μαύρο-Κόκκινο/Black-Red

Γραμμικό Διαδρόμου Στεγανό
Linear Corridor Waterproof



LED Type SMD2835 • Chip Brand Lumileds • Volt 220-240V 50/60Hz
Start Time 0.5 sec • PF >0.95 • Operating Temperature -30°C / +45°C
Connection Καλώδιο / Wire • Material Αλουμίνιο-Πλαστικό/ Aluminium-Plastic

LUMEN / WATT
180
lm/W

CRI
>70
Ra

BEAM ANGLE
40°/100°

5
YEARS
WARRANTY

| Code | Barcode | Dimension (mm) | | | Watt | Total Lumen | Kelvin | Weight (kg) | Packing | MOQ |
|-----------|---------------|----------------|-----|-----|------|-------------|--------|-------------|---------|-----|
| | | ↗ | ↔ | ↕ | | | | | | |
| 147-56682 | 5207227302442 | 650 | 165 | 195 | 100 | 18000 | 6000 | 2.600 | 1 | 1 |
| 147-56683 | 5207227302480 | 650 | 165 | 195 | 100 | 18000 | 4000 | 2.600 | 1 | 1 |
| 147-56684 | 5207227302435 | 920 | 165 | 195 | 150 | 27000 | 6000 | 3.500 | 1 | 1 |
| 147-56685 | 5207227302473 | 920 | 165 | 195 | 150 | 27000 | 4000 | 3.500 | 1 | 1 |







Φωτιστικά Πισίνας & Σποτ Συντριβανίου

Pool Lights
& Fountain Spots

Φωτιστικό Πισίνας LED
Swimming Pool LED Light



Moso
LED Driver

Λευκό/White



LED Type SMD2835 • Chip Brand Bridgelux • Volt 12V
Start Time 1 sec • PF >0.90 • Operating Temperature -30°C / +50°C
Material Πλαστικό-ABS/Plastic-ABS

| | | | |
|-----------------------------|------------------|-------------------|------------------------|
| LUMEN / WATT lm/W 100 | CRI Ra >80 | BEAM ANGLE 90° | 2 YEARS WARRANTY |
|-----------------------------|------------------|-------------------|------------------------|

| Code | Barcode | Dimension Ø (mm) ς | Watt | Amperage mA | Kelvin | Weight (kg) | Packing | MOQ |
|-----------|---------------|-----------------------|------|----------------|--------|----------------|---------|-----|
| 145-55900 | 5206139047595 | 230 x 58 | 18 | 1.875 | 6500 | 0.690 | 1/10 | 1 |
| 145-55904 | 5207227059872 | 230 x 58 | 18 | 1.875 | 3000 | 0.690 | 1/10 | 1 |
| 145-55901 | 5206139047618 | 230 x 58 | 18 | 1.875 | BLUE | 0.690 | 1/10 | 1 |
| 145-55902 | 5206139047632 | 230 x 58 | 18 | 1.875 | RGB | 0.690 | 1/10 | 1 |



• Συνδυάζεται με λαμπτήρες με κωδικούς 147-77570, 147-77571, 147-84572 και 147-84573 από τον κατάλογο των λαμπτήρων
• It can combined with lamps with codes 147-77570, 147-77571, 147-84572 and 147-84573 from the lamp catalogue.

| Code | Barcode | Energy Class | Type | Watt | = Watt | Kelvin | Lumen | Dimension Ø (mm) ς | Packing | MOQ |
|-----------|---------------|--------------|-------|------|--------|--------|-------|-----------------------|---------|-----|
| 147-77570 | 5207227153501 | F | PAR56 | 20 | | 6500 | 1900 | 178 x 114 | 1/12 | 1 |
| 147-77571 | 5207227153525 | F | PAR56 | 20 | | 3000 | 1800 | 178 x 114 | 1/12 | 1 |
| 147-77572 | 5207227174940 | | PAR56 | 20 | | BLUE | - | 178 x 114 | 1/12 | 1 |
| 147-77573 | 5206139042477 | | PAR56 | 20 | | RGB | - | 178 x 114 | 1/12 | 1 |

| Code | Barcode | Dimension (mm) | Packing | MOQ |
|-----------|---------------|-------------------|---------|-----|
| 147-77575 | 5207227153976 | 75x45x30mm | 1/50 | 1 |



• Συνδυάζεται με τηλεχειριστήριο με κωδικό 147-77575
• It can combined with controller with code 147-77575





Βάση Φωτιστικό Πισίνας Εξωτερικά - Outdoor Pool Light Base

○ Λευκό/White

IP68 IK05 CE

Volt 12V
Material Πλαστικό-ABS/Plastic-ABS

2
YEARS
WARRANTY

| Code | Barcode | Dimension (mm) Ø ι | Weight (kg) | Packing | MOQ |
|-----------|---------------|-----------------------|-------------|---------|-----|
| 145-55906 | 5207227147449 | 290 x 165 | 1.500 | 1/4 | 1 |



Σποτ Συντριβανιού LED - Underwater LED Spot

○ Ανοξείδωτο Ατσάλι/Stainless Steel

GU5,3 IP68 IK07 CE

Volt 12V
Operating Temperature -20°C / +40°C
Material Ανοξείδωτο Ατσάλι-Γυαλί/Stainless Steel-Glass

2
YEARS
WARRANTY

| Code | Barcode | Dimension (mm) Ø ι | Watt | Amperage mA | Weight (kg) | Packing | MOQ |
|-----------|---------------|-----------------------|------|-------------|-------------|---------|-----|
| 145-55920 | 5207227267024 | 100 x 86 | 7 | 12V | 0.590 | 1/20 | 1 |





○ Λευκό/White

Μπάλες Πλαστικές PMMA Γάλακτος για Εξωτερική Χρήση
Milk PMMA Plastic Balls for Outdoor Use



Operating Temperature -20°C / +50°C
 Material PMMA-ABS



| Code | Barcode | Dimension (mm) Ø ↗ | Weight (kg) | Packing | MOQ |
|-----------|---------------|--------------------------|-------------|---------|-----|
| 153-55300 | 5207227011788 | 200 x 200 | 0.279 | 1/18 | 1 |
| 153-55301 | 5207227011818 | 250 x 250 | 0.420 | 1/12 | 1 |
| 153-55302 | 5207227011115 | 300 x 300 | 0.600 | 1/8 | 1 |
| 153-55303 | 5207227011153 | 400 x 400 | 1.120 | 1/4 | 1 |



● Μελί/Honey

Μπάλες Πλαστικές PMMA Μελί για Εξωτερική Χρήση
Honey PMMA Plastic Balls for Outdoor Use



Operating Temperature -20°C / +50°C
 Material PMMA-ABS

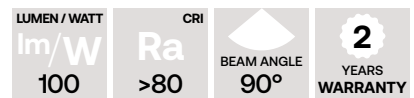

| Code | Barcode | Dimension (mm) Ø ↗ | Weight (kg) | Packing | MOQ |
|-----------|---------------|--------------------------|-------------|---------|-----|
| 153-55305 | 5207227011054 | 200 x 200 | 0.279 | 1/18 | 1 |
| 153-55306 | 5207227011092 | 250 x 250 | 0.420 | 1/12 | 1 |
| 153-55307 | 5207227011139 | 300 x 300 | 0.600 | 1/8 | 1 |
| 153-55308 | 5207227011177 | 400 x 400 | 1.120 | 1/4 | 1 |



Αξεσουάρ για Μπάλα Πλαστική - Accessories for Plastic Globe



Operating Temperature -20°C / +50°C
Material PMMA-ABS



| Code | Barcode | Dimension (mm) Ø ϕ | Weight (kg) | Packing | MOQ |
|-----------|---------------|--------------------------|-------------|---------|-----|
| 153-55310 | 5207227011832 | 60 x 1000 | 0.280 | 1/18 | 1 |
| 153-55311 | 5207227011030 | 60 x 1800 | 0.430 | 1/12 | 1 |
| 153-55312 | 5207227011078 | 60 x 170 | 0.600 | 1/8 | 1 |
| 153-55313 | 5207227011023 | 60 x 120 | 1.120 | 1/4 | 1 |





• Περιλαμβάνεται Τηλεχειριστήριο Υπερύθρων/
Included Infrared Remote Control

- Bat Cap: 2200mAh
- Bat Charg: 8h
- Bat Type: Lithium

○ Λευκό/White

Μπάλα Επαναφορτιζόμενη RGBWW Globe Rechargeable RGBWW



LED Type SMD2835 • Chip Brand Epistar • Volt 12V 50/60Hz
Start Time 0.5 sec • PF >0.90 • Operating Temperature -20°C / +75°C
Material Πολυεθυλαίνιο/Polyethylene



| Code | Barcode | Dimension Ø (mm) | Watt | Amperage mA | Kelvin | Weight (kg) | Packing | MOQ |
|-----------|---------------|---------------------|------|----------------|--------|----------------|---------|-----|
| 153-55351 | 5207227062476 | 400 | 5 | 1,000 | RGBWW | 1.500 | 1 | 1 |



Index

| Code | Page | Code | Page | Code | Page | Code | Page | Code | Page | Code | Page |
|------------|------|-----------|------|-----------|------|-----------|------|-----------|------|-----------|------|
| 145-20003 | 71 | 145-50130 | 263 | 145-50275 | 266 | 145-50444 | 269 | 145-50503 | 270 | 145-50742 | 275 |
| 145-24507 | 104 | 145-50131 | 263 | 145-50280 | 266 | 145-50445 | 269 | 145-50504 | 270 | 145-50743 | 275 |
| 145-24515 | 104 | 145-50132 | 263 | 145-50281 | 266 | 145-50450 | 268 | 145-50505 | 270 | 145-50744 | 275 |
| 145-24520 | 105 | 145-50133 | 263 | 145-50282 | 266 | 145-50451 | 268 | 145-50510 | 271 | 145-50745 | 275 |
| 145-24521 | 105 | 145-50134 | 263 | 145-50290 | 266 | 145-50452 | 268 | 145-50511 | 271 | 145-50750 | 274 |
| 145-24523 | 105 | 145-50135 | 263 | 145-50291 | 266 | 145-50453 | 268 | 145-50512 | 271 | 145-50751 | 274 |
| 145-24531 | 105 | 145-50200 | 264 | 145-50292 | 266 | 145-50454 | 268 | 145-50513 | 271 | 145-50752 | 274 |
| 145-24532 | 106 | 145-50201 | 264 | 145-50300 | 264 | 145-50455 | 268 | 145-50514 | 271 | 145-50753 | 274 |
| 145-24533 | 106 | 145-50202 | 264 | 145-50301 | 264 | 145-50456 | 268 | 145-50515 | 271 | 145-50754 | 274 |
| 145-24536 | 106 | 145-50203 | 264 | 145-50302 | 264 | 145-50457 | 268 | 145-50520 | 271 | 145-50755 | 274 |
| 145-24539 | 107 | 145-50204 | 264 | 145-50303 | 264 | 145-50458 | 268 | 145-50521 | 271 | 145-50756 | 274 |
| 145-28000 | 168 | 145-50205 | 264 | 145-50304 | 264 | 145-50459 | 268 | 145-50522 | 271 | 145-50757 | 274 |
| 145-28001 | 168 | 145-50210 | 265 | 145-50305 | 264 | 145-50460 | 268 | 145-50523 | 271 | 145-50758 | 274 |
| 145-28010 | 168 | 145-50211 | 265 | 145-50310 | 264 | 145-50461 | 268 | 145-50524 | 271 | 145-50759 | 274 |
| 145-28100 | 169 | 145-50212 | 265 | 145-50311 | 264 | 145-50462 | 268 | 145-50525 | 271 | 145-50760 | 274 |
| 145-28110 | 169 | 145-50213 | 265 | 145-50312 | 264 | 145-50463 | 268 | 145-50530 | 271 | 145-50761 | 274 |
| 145-28120 | 169 | 145-50214 | 265 | 145-50313 | 264 | 145-50464 | 268 | 145-50531 | 271 | 145-50762 | 274 |
| 145-28121 | 170 | 145-50215 | 265 | 145-50314 | 264 | 145-50465 | 268 | 145-50532 | 271 | 145-50763 | 274 |
| 145-28122 | 170 | 145-50220 | 265 | 145-50315 | 264 | 145-50466 | 268 | 145-50533 | 271 | 145-50764 | 274 |
| 145-28123 | 170 | 145-50221 | 265 | 145-50320 | 264 | 145-50467 | 268 | 145-50534 | 271 | 145-50765 | 274 |
| 145-28124 | 170 | 145-50222 | 265 | 145-50321 | 264 | 145-50468 | 270 | 145-50535 | 271 | 145-50766 | 274 |
| 145-28130 | 171 | 145-50223 | 265 | 145-50322 | 264 | 145-50469 | 270 | 145-50540 | 271 | 145-50767 | 274 |
| 145-28131 | 171 | 145-50224 | 265 | 145-50323 | 264 | 145-50470 | 270 | 145-50541 | 271 | 145-50768 | 276 |
| 145-28132 | 171 | 145-50225 | 265 | 145-50324 | 264 | 145-50471 | 270 | 145-50542 | 271 | 145-50769 | 276 |
| 145-28133 | 171 | 145-50230 | 265 | 145-50325 | 264 | 145-50472 | 270 | 145-50543 | 271 | 145-50770 | 276 |
| 145-28134* | 171 | 145-50231 | 265 | 145-50400 | 268 | 145-50473 | 270 | 145-50544 | 271 | 145-50771 | 276 |
| 145-28135 | 171 | 145-50232 | 265 | 145-50401 | 268 | 145-50474 | 270 | 145-50545 | 271 | 145-50772 | 276 |
| 145-28136 | 171 | 145-50233 | 265 | 145-50402 | 268 | 145-50475 | 270 | 145-50700 | 274 | 145-50773 | 276 |
| 145-28140 | 172 | 145-50234 | 265 | 145-50403 | 268 | 145-50476 | 270 | 145-50701 | 274 | 145-50774 | 276 |
| 145-28150 | 172 | 145-50235 | 265 | 145-50404 | 268 | 145-50477 | 270 | 145-50702 | 274 | 145-50775 | 276 |
| 145-28151 | 173 | 145-50240 | 262 | 145-50405 | 268 | 145-50478 | 270 | 145-50703 | 274 | 145-50776 | 276 |
| 145-28152 | 173 | 145-50241 | 262 | 145-50410 | 269 | 145-50479 | 270 | 145-50704 | 274 | 145-50777 | 276 |
| 145-28153 | 173 | 145-50242 | 262 | 145-50411 | 269 | 145-50480 | 270 | 145-50705 | 274 | 145-50778 | 276 |
| 145-28154 | 173 | 145-50243 | 262 | 145-50412 | 269 | 145-50481 | 270 | 145-50710 | 275 | 145-50779 | 276 |
| 145-28601 | 172 | 145-50244 | 262 | 145-50413 | 269 | 145-50482 | 270 | 145-50711 | 275 | 145-50780 | 276 |
| 145-50100 | 262 | 145-50245 | 262 | 145-50414 | 269 | 145-50483 | 270 | 145-50712 | 275 | 145-50781 | 276 |
| 145-50101 | 262 | 145-50250 | 262 | 145-50415 | 269 | 145-50484 | 270 | 145-50713 | 275 | 145-50782 | 276 |
| 145-50102 | 262 | 145-50251 | 262 | 145-50420 | 269 | 145-50485 | 270 | 145-50714 | 275 | 145-50783 | 276 |
| 145-50103 | 262 | 145-50252 | 262 | 145-50421 | 269 | 145-50486 | 272 | 145-50715 | 275 | 145-50784 | 276 |
| 145-50104 | 262 | 145-50253 | 262 | 145-50422 | 269 | 145-50487 | 272 | 145-50720 | 275 | 145-50785 | 276 |
| 145-50105 | 262 | 145-50254 | 262 | 145-50423 | 269 | 145-50488 | 272 | 145-50721 | 275 | 145-50786 | 278 |
| 145-50110 | 263 | 145-50255 | 262 | 145-50424 | 269 | 145-50489 | 272 | 145-50722 | 275 | 145-50787 | 278 |
| 145-50111 | 263 | 145-50260 | 262 | 145-50425 | 269 | 145-50490 | 272 | 145-50723 | 275 | 145-50788 | 278 |
| 145-50112 | 263 | 145-50261 | 262 | 145-50430 | 269 | 145-50491 | 272 | 145-50724 | 275 | 145-50789 | 278 |
| 145-50113 | 263 | 145-50262 | 262 | 145-50431 | 269 | 145-50492 | 272 | 145-50725 | 275 | 145-50790 | 278 |
| 145-50114 | 263 | 145-50263 | 262 | 145-50432 | 269 | 145-50493 | 272 | 145-50730 | 275 | 145-50791 | 278 |
| 145-50115 | 263 | 145-50264 | 262 | 145-50433 | 269 | 145-50494 | 272 | 145-50731 | 275 | 145-50792 | 278 |
| 145-50120 | 263 | 145-50265 | 262 | 145-50434 | 269 | 145-50495 | 272 | 145-50732 | 275 | 145-50793 | 278 |
| 145-50121 | 263 | 145-50270 | 266 | 145-50435 | 269 | 145-50496 | 272 | 145-50733 | 275 | 145-50794 | 278 |
| 145-50122 | 263 | 145-50271 | 266 | 145-50440 | 269 | 145-50497 | 272 | 145-50734 | 275 | 145-50795 | 278 |
| 145-50123 | 263 | 145-50272 | 266 | 145-50441 | 269 | 145-50500 | 270 | 145-50735 | 275 | 145-50796 | 278 |
| 145-50124 | 263 | 145-50273 | 266 | 145-50442 | 269 | 145-50501 | 270 | 145-50740 | 275 | 145-50797 | 278 |
| 145-50125 | 263 | 145-50274 | 266 | 145-50443 | 269 | 145-50502 | 270 | 145-50741 | 275 | 145-50800 | 276 |

INDEX

| Code | Page | Code | Page | Code | Page | Code | Page | Code | Page | Code | Page |
|-----------|------|-----------|------|-----------|------|-----------|------|-----------|------|-----------|------|
| 145-50801 | 276 | 145-53140 | 283 | 145-56188 | 118 | 145-59008 | 325 | 145-59117 | 339 | 145-59300 | 328 |
| 145-50802 | 276 | 145-53141 | 283 | 145-56190 | 120 | 145-59009 | 325 | 145-59119 | 340 | 145-59301 | 328 |
| 145-50803 | 276 | 145-53142 | 283 | 145-56191 | 120 | 145-59010 | 325 | 145-59120 | 340 | 145-59302 | 328 |
| 145-50804 | 276 | 145-53150 | 283 | 145-56192 | 120 | 145-59011 | 322 | 145-59121 | 340 | 145-59303 | 328 |
| 145-50805 | 276 | 145-53151 | 283 | 145-56195 | 118 | 145-59020 | 322 | 145-59122 | 341 | 145-59304 | 328 |
| 145-50810 | 277 | 145-53152 | 283 | 145-56196 | 120 | 145-59021 | 322 | 145-59123 | 341 | 145-59305 | 328 |
| 145-50811 | 277 | 145-53160 | 283 | 145-56197 | 120 | 145-59022 | 323 | 145-59124 | 341 | 145-59306 | 328 |
| 145-50812 | 277 | 145-53161 | 283 | 145-56230 | 114 | 145-59023 | 323 | 145-59125 | 342 | 145-59307 | 328 |
| 145-50813 | 277 | 145-53162 | 283 | 145-56231 | 114 | 145-59024 | 323 | 145-59126 | 342 | 145-59310 | 329 |
| 145-50814 | 277 | 145-53170 | 283 | 145-56232 | 114 | 145-59025 | 324 | 145-59127 | 342 | 145-59311 | 329 |
| 145-50815 | 277 | 145-53171 | 283 | 145-56233 | 114 | 145-59026 | 324 | 145-59130 | 334 | 145-59312 | 331 |
| 145-50820 | 277 | 145-53172 | 283 | 145-56234 | 114 | 145-59027 | 324 | 145-59131 | 334 | 145-59313 | 331 |
| 145-50821 | 277 | 145-53200 | 281 | 145-56235 | 114 | 145-59028 | 325 | 145-59132 | 334 | 145-59314 | 331 |
| 145-50822 | 277 | 145-53201 | 281 | 145-56240 | 115 | 145-59029 | 325 | 145-59133 | 335 | 145-59315 | 329 |
| 145-50823 | 277 | 145-53202 | 281 | 145-56241 | 115 | 145-59030 | 325 | 145-59134 | 335 | 145-59316 | 329 |
| 145-50824 | 277 | 145-53210 | 281 | 145-56242 | 115 | 145-59031 | 322 | 145-59135 | 335 | 145-59322 | 333 |
| 145-50825 | 277 | 145-53211 | 281 | 145-56250 | 115 | 145-59040 | 319 | 145-59136 | 336 | 145-59324 | 333 |
| 145-50830 | 277 | 145-53212 | 281 | 145-56251 | 115 | 145-59041 | 319 | 145-59137 | 336 | 145-59326 | 333 |
| 145-50831 | 277 | 145-53220 | 281 | 145-56252 | 115 | 145-59050 | 318 | 145-59138 | 336 | 145-59328 | 333 |
| 145-50832 | 277 | 145-53221 | 281 | 145-56290 | 119 | 145-59051 | 318 | 145-59139 | 337 | 145-59330 | 330 |
| 145-50833 | 277 | 145-53222 | 281 | 145-56291 | 119 | 145-59052 | 318 | 145-59140 | 337 | 145-59331 | 330 |
| 145-50834 | 277 | 145-55090 | 333 | 145-56310 | 112 | 145-59053 | 318 | 145-59141 | 337 | 145-59350 | 330 |
| 145-50835 | 277 | 145-55092 | 128 | 145-56311 | 112 | 145-59054 | 318 | 145-59142 | 338 | 145-59351 | 330 |
| 145-50840 | 277 | 145-55301 | 143 | 145-56312 | 112 | 145-59055 | 318 | 145-59143 | 338 | 145-59380 | 331 |
| 145-50841 | 277 | 145-55302 | 143 | 145-56313 | 112 | 145-59056 | 318 | 145-59144 | 338 | 145-59381 | 331 |
| 145-50842 | 277 | 145-55307 | 143 | 145-56314 | 112 | 145-59057 | 318 | 145-59146 | 339 | 145-59400 | 332 |
| 145-50843 | 277 | 145-55900 | 396 | 145-56315 | 112 | 145-59058 | 319 | 145-59147 | 339 | 145-59401 | 332 |
| 145-50844 | 277 | 145-55901 | 396 | 145-56320 | 112 | 145-59059 | 319 | 145-59149 | 340 | 145-59402 | 332 |
| 145-50845 | 277 | 145-55902 | 396 | 145-56321 | 112 | 145-59070 | 320 | 145-59150 | 340 | 145-59403 | 332 |
| 145-53000 | 280 | 145-55904 | 396 | 145-56322 | 112 | 145-59071 | 321 | 145-59151 | 340 | 145-59404 | 332 |
| 145-53001 | 280 | 145-55906 | 397 | 145-56323 | 112 | 145-59072 | 321 | 145-59152 | 341 | 145-59405 | 332 |
| 145-53002 | 280 | 145-55920 | 397 | 145-56324 | 112 | 145-59073 | 320 | 145-59153 | 341 | 145-59406 | 332 |
| 145-53010 | 280 | 145-56140 | 116 | 145-56325 | 112 | 145-59075 | 320 | 145-59154 | 341 | 145-59407 | 332 |
| 145-53011 | 280 | 145-56141 | 116 | 145-56330 | 113 | 145-59080 | 320 | 145-59155 | 342 | 145-59408 | 331 |
| 145-53012 | 280 | 145-56142 | 116 | 145-56331 | 113 | 145-59081 | 321 | 145-59156 | 342 | 145-59409 | 331 |
| 145-53020 | 280 | 145-56143 | 116 | 145-56332 | 113 | 145-59083 | 320 | 145-59157 | 342 | 145-59410 | 331 |
| 145-53021 | 280 | 145-56144 | 116 | 145-56333 | 113 | 145-59085 | 320 | 145-59240 | 343 | 145-59411 | 331 |
| 145-53022 | 280 | 145-56145 | 116 | 145-56334 | 113 | 145-59100 | 334 | 145-59241 | 343 | 145-59500 | 292 |
| 145-53030 | 280 | 145-56146 | 116 | 145-56335 | 113 | 145-59101 | 334 | 145-59242 | 343 | 145-59501 | 292 |
| 145-53031 | 280 | 145-56147 | 116 | 145-56350 | 110 | 145-59102 | 334 | 145-59243 | 343 | 145-59502 | 292 |
| 145-53032 | 280 | 145-56148 | 116 | 145-56351 | 110 | 145-59103 | 335 | 145-59245 | 344 | 145-59503 | 292 |
| 145-53100 | 282 | 145-56150 | 117 | 145-56390 | 120 | 145-59104 | 335 | 145-59246 | 344 | 145-59504 | 293 |
| 145-53101 | 282 | 145-56151 | 117 | 145-56391 | 120 | 145-59105 | 335 | 145-59247 | 344 | 145-59505 | 293 |
| 145-53102 | 282 | 145-56152 | 117 | 145-56392 | 120 | 145-59106 | 336 | 145-59248 | 345 | 145-59506 | 293 |
| 145-53110 | 282 | 145-56153 | 117 | 145-56393 | 120 | 145-59107 | 336 | 145-59249 | 345 | 145-59507 | 293 |
| 145-53111 | 282 | 145-56154 | 117 | 145-59000 | 322 | 145-59108 | 336 | 145-59250 | 343 | 145-59508 | 294 |
| 145-53112 | 282 | 145-56155 | 117 | 145-59001 | 322 | 145-59109 | 337 | 145-59251 | 343 | 145-59509 | 294 |
| 145-53120 | 282 | 145-56156 | 117 | 145-59002 | 323 | 145-59110 | 337 | 145-59252 | 343 | 145-59510 | 294 |
| 145-53121 | 282 | 145-56157 | 117 | 145-59003 | 323 | 145-59111 | 337 | 145-59253 | 343 | 145-59511 | 294 |
| 145-53122 | 282 | 145-56158 | 117 | 145-59004 | 323 | 145-59112 | 338 | 145-59255 | 344 | 145-59512 | 295 |
| 145-53130 | 282 | 145-56180 | 138 | 145-59005 | 324 | 145-59113 | 338 | 145-59256 | 344 | 145-59513 | 295 |
| 145-53131 | 282 | 145-56186 | 119 | 145-59006 | 324 | 145-59114 | 338 | 145-59257 | 344 | 145-59514 | 296 |
| 145-53132 | 282 | 145-56187 | 118 | 145-59007 | 324 | 145-59116 | 339 | 145-59258 | 345 | 145-59515 | 296 |

| Code | Page | Code | Page | Code | Page | Code | Page | Code | Page | Code | Page |
|-----------|------|------------|------|------------|------|-----------|------|------------|------|------------|------|
| 145-59516 | 296 | 145-59901 | 310 | 145-65018 | 124 | 145-68202 | 127 | 145-68530 | 141 | 145-70120 | 191 |
| 145-59517 | 296 | 145-59902 | 310 | 145-65020 | 125 | 145-68205 | 127 | 145-68531 | 141 | 145-70121 | 191 |
| 145-59518 | 294 | 145-59903 | 310 | 145-65021 | 125 | 145-68206 | 127 | 145-68532 | 141 | 145-70122 | 191 |
| 145-59519 | 294 | 145-59904 | 311 | 145-65022 | 125 | 145-68252 | 128 | 145-68533 | 141 | 145-70123 | 191 |
| 145-59520 | 297 | 145-59905 | 311 | 145-65023 | 125 | 145-68400 | 133 | 145-68534 | 141 | 145-70125 | 191 |
| 145-59522 | 298 | 145-59906 | 311 | 145-65100 | 122 | 145-68401 | 133 | 145-68535 | 141 | 145-70126 | 191 |
| 145-59523 | 298 | 145-59907 | 311 | 145-65200 | 126 | 145-68402 | 133 | 145-68536 | 141 | 145-70127 | 191 |
| 145-59524 | 298 | 145-59908 | 311 | 145-65201 | 126 | 145-68410 | 133 | 145-68537 | 141 | 145-70128 | 191 |
| 145-59525 | 299 | 145-59910 | 312 | 145-65202 | 126 | 145-68411 | 133 | 145-68538 | 141 | 145-70130 | 192 |
| 145-59526 | 299 | 145-59911 | 312 | 145-65210 | 126 | 145-68412 | 133 | 145-68569 | 142 | 145-70131 | 192 |
| 145-59527 | 299 | 145-59912 | 312 | 145-65211 | 126 | 145-68420 | 134 | 145-68570 | 142 | 145-70132 | 192 |
| 145-59528 | 297 | 145-59913 | 313 | 145-65800 | 146 | 145-68421 | 134 | 145-68571 | 142 | 145-70133 | 192 |
| 145-59529 | 298 | 145-59914 | 313 | 145-65801 | 146 | 145-68422 | 134 | 145-68572 | 142 | 145-70134 | 192 |
| 145-59530 | 298 | 145-59915 | 314 | 145-65802 | 146 | 145-68423 | 134 | 145-68573 | 142 | 145-70135 | 192 |
| 145-59531 | 299 | 145-59916 | 315 | 145-65803 | 146 | 145-68424 | 134 | 145-68575 | 142 | 145-70136 | 192 |
| 145-59532 | 299 | 145-59917 | 315 | 145-65806 | 146 | 145-68425 | 134 | 145-68576 | 142 | 145-70137 | 192 |
| 145-59533 | 297 | 145-59918 | 315 | 145-65807 | 146 | 145-68430 | 135 | 145-68577 | 142 | 145-70140 | 193 |
| 145-59540 | 300 | 145-59919 | 314 | 145-67123 | 391 | 145-68431 | 135 | 145-68578 | 142 | 145-70141 | 193 |
| 145-59541 | 300 | 145-59920 | 314 | 145-67124 | 391 | 145-68432 | 135 | 145-68579 | 142 | 145-70142 | 193 |
| 145-59542 | 300 | 145-59921 | 314 | 145-67126 | 391 | 145-68433 | 135 | 145-68600 | 130 | 145-70143 | 193 |
| 145-59543 | 300 | 145-59922 | 313 | 145-67130 | 391 | 145-68434 | 135 | 145-68601 | 130 | 145-70150 | 194 |
| 145-59544 | 300 | 145-59923 | 312 | 145-67131 | 391 | 145-68435 | 135 | 145-68602 | 130 | 145-70151 | 194 |
| 145-59545 | 300 | 145-59924 | 312 | 145-67132 | 391 | 145-68436 | 135 | 145-68604 | 130 | 145-70152 | 194 |
| 145-59550 | 301 | 145-59925 | 313 | 145-67135 | 392 | 145-68437 | 135 | 145-68606 | 131 | 145-70157 | 194 |
| 145-59551 | 301 | 145-59926 | 313 | 145-67136 | 392 | 145-68438 | 135 | 145-68607 | 131 | 145-70170 | 195 |
| 145-59552 | 301 | 145-59930 | 307 | 145-67138* | 392 | 145-68450 | 133 | 145-68608 | 131 | 145-70171 | 195 |
| 145-59553 | 303 | 145-59931 | 307 | 145-67143 | 392 | 145-68451 | 133 | 145-68609 | 131 | 145-70172 | 195 |
| 145-59554 | 302 | 145-59932 | 306 | 145-67144 | 392 | 145-68452 | 133 | 145-68610 | 131 | 145-70173 | 195 |
| 145-59555 | 302 | 145-59933 | 306 | 145-67145 | 392 | 145-68453 | 133 | 145-68611 | 131 | 145-70230 | 198 |
| 145-59556 | 302 | 145-59934 | 307 | 145-67146 | 392 | 145-68490 | 137 | 145-68612 | 131 | 145-70231 | 198 |
| 145-59557 | 301 | 145-59935 | 307 | 145-67150 | 390 | 145-68491 | 137 | 145-68613 | 131 | 145-70232 | 198 |
| 145-59558 | 303 | 145-59936 | 306 | 145-67151 | 390 | 145-68492 | 137 | 145-68614 | 131 | 145-70233 | 198 |
| 145-59559 | 303 | 145-59937 | 306 | 145-67152 | 390 | 145-68500 | 140 | 145-68620 | 130 | 145-70235 | 199 |
| 145-59560 | 303 | 145-59938 | 307 | 145-68000 | 132 | 145-68501 | 140 | 145-68621 | 130 | 145-70236 | 199 |
| 145-59561 | 301 | 145-59939 | 307 | 145-68001 | 132 | 145-68502 | 140 | 145-68622 | 130 | 145-70237 | 199 |
| 145-59562 | 301 | 145-59940 | 309 | 145-68010 | 132 | 145-68506 | 140 | 145-68900 | 123 | 145-70240* | 200 |
| 145-59563 | 303 | 145-59941 | 309 | 145-68011 | 132 | 145-68507 | 140 | 145-68902 | 122 | 145-70241* | 200 |
| 145-59564 | 302 | 145-59942 | 307 | 145-68012 | 132 | 145-68508 | 140 | 145-68905 | 123 | 145-70242* | 200 |
| 145-59565 | 302 | 145-59950* | 308 | 145-68020 | 132 | 145-68510 | 140 | 145-68906 | 123 | 145-70243 | 200 |
| 145-59566 | 302 | 145-59952* | 308 | 145-68021 | 132 | 145-68511 | 140 | 145-68910 | 122 | 145-70244 | 201 |
| 145-59567 | 301 | 145-59953* | 308 | 145-68022 | 132 | 145-68512 | 140 | 145-68911 | 122 | 145-70245 | 201 |
| 145-59568 | 303 | 145-59954 | 308 | 145-68080 | 136 | 145-68513 | 140 | 145-68912 | 122 | 145-70246 | 201 |
| 145-59569 | 301 | 145-59955 | 308 | 145-68081 | 136 | 145-68514 | 140 | 145-70024 | 177 | 145-70247 | 201 |
| 145-59570 | 300 | 145-59956 | 308 | 145-68090 | 136 | 145-68515 | 140 | 145-70025 | 177 | 145-70248 | 200 |
| 145-59571 | 300 | 145-59990 | 310 | 145-68091 | 136 | 145-68516 | 140 | 145-70043 | 176 | 145-70250 | 203 |
| 145-59572 | 300 | 145-59991 | 310 | 145-68092 | 137 | 145-68517 | 140 | 145-70044 | 176 | 145-70251 | 203 |
| 145-59573 | 300 | 145-59992 | 310 | 145-68093 | 137 | 145-68518 | 140 | 145-70045 | 177 | 145-70252 | 203 |
| 145-59574 | 300 | 145-59993 | 310 | 145-68095 | 120 | 145-68520 | 141 | 145-70046* | 176 | 145-70253 | 203 |
| 145-59575 | 300 | 145-65011 | 124 | 145-68096 | 137 | 145-68521 | 141 | 145-70047 | 176 | 145-70275 | 205 |
| 145-59580 | 301 | 145-65012 | 124 | 145-68097 | 137 | 145-68522 | 141 | 145-70102 | 190 | 145-70276 | 205 |
| 145-59801 | 124 | 145-65014 | 124 | 145-68098 | 137 | 145-68526 | 141 | 145-70103 | 190 | 145-70277 | 205 |
| 145-59802 | 124 | 145-65015 | 124 | 145-68099 | 136 | 145-68527 | 141 | 145-70104 | 190 | 145-70278 | 205 |
| 145-59900 | 310 | 145-65017 | 124 | 145-68201 | 127 | 145-68528 | 141 | 145-70105 | 190 | 145-70320 | 208 |

| Code | Page | Code | Page | Code | Page | Code | Page | Code | Page | Code | Page |
|------------|------|-----------|------|-----------|------|-----------|------|------------|------|-----------|------|
| 145-70321 | 208 | 145-70926 | 258 | 145-71038 | 241 | 145-71151 | 246 | 145-71506 | 231 | 145-72601 | 187 |
| 145-70322 | 208 | 145-70927 | 251 | 145-71039 | 241 | 145-71152 | 246 | 145-71508 | 230 | 145-72602 | 187 |
| 145-70323 | 208 | 145-70928 | 250 | 145-71050 | 242 | 145-71153 | 246 | 145-71509 | 231 | 145-72700 | 187 |
| 145-70324 | 208 | 145-70930 | 260 | 145-71051 | 242 | 145-71154 | 246 | 145-71513 | 232 | 145-72701 | 187 |
| 145-70360 | 209 | 145-70931 | 260 | 145-71052 | 242 | 145-71155 | 246 | 145-71514 | 232 | 145-72702 | 187 |
| 145-70361 | 209 | 145-70932 | 252 | 145-71053 | 242 | 145-71160 | 244 | 145-71520 | 232 | 145-72900 | 214 |
| 145-70362 | 209 | 145-70940 | 258 | 145-71054 | 242 | 145-71161 | 244 | 145-71521 | 232 | 145-72901 | 214 |
| 145-70363 | 209 | 145-70950 | 252 | 145-71055 | 242 | 145-71162 | 244 | 145-71600 | 234 | 145-72902 | 214 |
| 145-70364 | 209 | 145-70951 | 254 | 145-71060 | 240 | 145-71163 | 244 | 145-71603 | 234 | 145-72903 | 214 |
| 145-70410 | 210 | 145-70952 | 250 | 145-71061 | 240 | 145-71164 | 244 | 145-71604 | 234 | 145-72910 | 215 |
| 145-70411 | 210 | 145-70953 | 251 | 145-71062 | 240 | 145-71165 | 244 | 145-71605 | 234 | 145-72911 | 215 |
| 145-70412 | 210 | 145-70954 | 252 | 145-71063 | 240 | 145-71166 | 244 | 145-71606 | 234 | 145-72912 | 215 |
| 145-70413 | 210 | 145-70955 | 254 | 145-71064 | 240 | 145-71167 | 244 | 145-71610 | 235 | 145-72913 | 215 |
| 145-70414* | 210 | 145-70956 | 255 | 145-71065 | 240 | 145-71168 | 244 | 145-71650 | 237 | 145-72914 | 215 |
| 145-70415* | 210 | 145-70957 | 256 | 145-71066 | 240 | 145-71180 | 247 | 145-71651 | 237 | 145-72915 | 215 |
| 145-70418 | 210 | 145-70958 | 257 | 145-71067 | 240 | 145-71181 | 247 | 145-71652 | 237 | 145-72920 | 215 |
| 145-70440 | 211 | 145-70959 | 257 | 145-71068 | 240 | 145-71182 | 247 | 145-72000 | 182 | 145-72921 | 215 |
| 145-70441 | 211 | 145-70960 | 257 | 145-71080 | 243 | 145-71183 | 247 | 145-72001 | 182 | 145-72922 | 215 |
| 145-70442 | 211 | 145-70961 | 258 | 145-71081 | 243 | 145-71184 | 247 | 145-72002 | 182 | 145-72923 | 215 |
| 145-70445 | 211 | 145-70962 | 258 | 145-71082 | 243 | 145-71202 | 246 | 145-72003 | 182 | 145-72924 | 215 |
| 145-70446 | 211 | 145-70963 | 259 | 145-71083 | 243 | 145-71203 | 246 | 145-72005 | 182 | 145-72925 | 215 |
| 145-70447 | 211 | 145-70964 | 259 | 145-71084 | 243 | 145-71204 | 246 | 145-72006 | 182 | 145-72930 | 216 |
| 145-70470 | 212 | 145-70965 | 259 | 145-71100 | 244 | 145-71205 | 246 | 145-72007 | 182 | 145-72931 | 216 |
| 145-70471 | 212 | 145-70966 | 259 | 145-71101 | 244 | 145-71400 | 224 | 145-72008 | 182 | 145-72932 | 216 |
| 145-70472 | 212 | 145-71000 | 240 | 145-71102 | 244 | 145-71402 | 224 | 145-72010 | 183 | 145-72940 | 216 |
| 145-70473 | 212 | 145-71001 | 240 | 145-71103 | 244 | 145-71403 | 224 | 145-72011 | 183 | 145-72941 | 216 |
| 145-70474 | 212 | 145-71002 | 240 | 145-71104 | 244 | 145-71404 | 225 | 145-72012 | 183 | 145-72942 | 216 |
| 145-70475 | 212 | 145-71003 | 240 | 145-71105 | 244 | 145-71405 | 224 | 145-72013 | 183 | 145-72943 | 216 |
| 145-70900 | 250 | 145-71004 | 240 | 145-71110 | 245 | 145-71406 | 225 | 145-72020 | 183 | 145-72950 | 217 |
| 145-70901 | 250 | 145-71005 | 240 | 145-71111 | 245 | 145-71410 | 226 | 145-72021 | 183 | 145-72951 | 217 |
| 145-70902 | 250 | 145-71010 | 241 | 145-71112 | 245 | 145-71413 | 226 | 145-72022 | 183 | 145-72952 | 217 |
| 145-70903 | 251 | 145-71011 | 241 | 145-71113 | 245 | 145-71415 | 226 | 145-72023 | 183 | 145-72953 | 217 |
| 145-70904 | 252 | 145-71012 | 241 | 145-71114 | 245 | 145-71419 | 227 | 145-72024 | 183 | 145-72960 | 217 |
| 145-70905 | 254 | 145-71013 | 241 | 145-71115 | 245 | 145-71421 | 226 | 145-72025 | 183 | 145-72961 | 217 |
| 145-70906 | 251 | 145-71014 | 241 | 145-71116 | 245 | 145-71422 | 224 | 145-72026 | 183 | 145-72962 | 217 |
| 145-70907 | 254 | 145-71015 | 241 | 145-71117 | 245 | 145-71430 | 236 | 145-72027* | 183 | 145-72963 | 217 |
| 145-70908 | 251 | 145-71016 | 241 | 145-71118 | 245 | 145-71431 | 236 | 145-72028 | 184 | 145-72990 | 221 |
| 145-70909 | 254 | 145-71017 | 241 | 145-71119 | 245 | 145-71432 | 236 | 145-72029 | 184 | 145-72991 | 221 |
| 145-70910 | 255 | 145-71018 | 241 | 145-71120 | 245 | 145-71433 | 236 | 145-72030 | 184 | 145-73000 | 179 |
| 145-70911 | 258 | 145-71019 | 241 | 145-71121 | 245 | 145-71450 | 228 | 145-72031 | 184 | 145-73001 | 179 |
| 145-70912 | 253 | 145-71020 | 241 | 145-71122 | 245 | 145-71451 | 228 | 145-72032 | 184 | 145-73002 | 179 |
| 145-70913 | 253 | 145-71021 | 241 | 145-71123 | 245 | 145-71452 | 228 | 145-72033 | 185 | 145-73003 | 179 |
| 145-70914 | 253 | 145-71022 | 241 | 145-71130 | 245 | 145-71453 | 228 | 145-72050 | 186 | 145-73004 | 179 |
| 145-70915 | 252 | 145-71023 | 241 | 145-71131 | 245 | 145-71470 | 229 | 145-72051 | 186 | 145-73005 | 179 |
| 145-70916 | 255 | 145-71024 | 241 | 145-71132 | 245 | 145-71471 | 229 | 145-72052 | 186 | 145-73006 | 179 |
| 145-70917 | 260 | 145-71030 | 241 | 145-71133 | 245 | 145-71472 | 229 | 145-72053* | 186 | 145-73007 | 179 |
| 145-70918 | 257 | 145-71031 | 241 | 145-71134 | 245 | 145-71473 | 229 | 145-72060 | 186 | 145-73008 | 179 |
| 145-70919 | 257 | 145-71032 | 241 | 145-71135 | 245 | 145-71500 | 230 | 145-72061 | 186 | 145-73009 | 179 |
| 145-70920 | 256 | 145-71033 | 241 | 145-71136 | 245 | 145-71501 | 230 | 145-72062 | 186 | 145-73010 | 179 |
| 145-70921 | 256 | 145-71034 | 241 | 145-71137 | 245 | 145-71502 | 230 | 145-72063 | 186 | 145-73011 | 179 |
| 145-70922 | 256 | 145-71035 | 241 | 145-71138 | 245 | 145-71503 | 230 | 145-72500 | 185 | 145-73012 | 179 |
| 145-70923 | 256 | 145-71036 | 241 | 145-71139 | 245 | 145-71504 | 231 | 145-72550 | 232 | 145-73300 | 197 |
| 145-70925 | 260 | 145-71037 | 241 | 145-71150 | 246 | 145-71505 | 231 | 145-72600 | 187 | 145-73301 | 197 |

| Code | Page | Code | Page | Code | Page | Code | Page | Code | Page | Code | Page |
|-----------|------|-----------|------|-----------|------|-----------|------|-----------|------|-----------|------|
| 145-73302 | 197 | 145-73930 | 219 | 145-79716 | 284 | 146-57055 | 380 | 146-58012 | 386 | 147-24105 | 101 |
| 145-73305 | 197 | 145-73931 | 219 | 145-79717 | 284 | 146-57056 | 380 | 146-58013 | 386 | 147-24110 | 102 |
| 145-73310 | 196 | 145-73932 | 219 | 145-79718 | 284 | 146-57057 | 380 | 146-58014 | 386 | 147-24111 | 102 |
| 145-73311 | 196 | 145-73933 | 219 | 145-79719 | 284 | 146-57058 | 380 | 146-58015 | 386 | 147-24112 | 101 |
| 145-73312 | 196 | 145-73934 | 219 | 145-79720 | 284 | 146-57059 | 380 | 146-58016 | 386 | 147-24120 | 96 |
| 145-73313 | 196 | 145-73935 | 219 | 145-79721 | 284 | 146-57060 | 380 | 146-58017 | 386 | 147-24121 | 97 |
| 145-73330 | 198 | 145-73936 | 219 | 145-79722 | 284 | 146-57061 | 380 | 146-58018 | 386 | 147-24122 | 98 |
| 145-73331 | 198 | 145-73940 | 220 | 145-79723 | 284 | 146-57062 | 381 | 146-58019 | 386 | 147-24123 | 98 |
| 145-73332 | 198 | 145-73941 | 220 | 145-79800 | 286 | 146-57063 | 381 | 146-58020 | 386 | 147-24124 | 98 |
| 145-73333 | 198 | 145-73942 | 220 | 145-79801 | 286 | 146-57064 | 381 | 146-58021 | 388 | 147-24125 | 96 |
| 145-73334 | 198 | 145-73943 | 220 | 145-79802 | 286 | 146-57065 | 381 | 146-58022 | 388 | 147-24126 | 97 |
| 145-73350 | 199 | 145-73944 | 220 | 145-79803 | 286 | 146-57066 | 381 | 146-69020 | 373 | 147-24127 | 96 |
| 145-73351 | 199 | 145-73945 | 220 | 145-79804 | 286 | 146-57067 | 381 | 146-69021 | 373 | 147-24128 | 97 |
| 145-73352 | 199 | 145-73946 | 220 | 145-79805 | 286 | 146-57068 | 381 | 146-69022 | 373 | 147-24130 | 99 |
| 145-73353 | 199 | 145-73950 | 214 | 145-79806 | 286 | 146-57069 | 381 | 146-69023 | 373 | 147-24131 | 99 |
| 145-73360 | 206 | 145-73951 | 214 | 145-79807 | 286 | 146-57070 | 381 | 146-69024 | 373 | 147-24132 | 99 |
| 145-73361 | 206 | 145-73952 | 214 | 145-79808 | 286 | 146-57071 | 381 | 146-69025 | 373 | 147-24133 | 99 |
| 145-73362 | 206 | 145-73953 | 214 | 145-79809 | 288 | 146-57072 | 381 | 146-69026 | 373 | 147-24134 | 99 |
| 145-73363 | 206 | 145-73954 | 214 | 145-79810 | 288 | 146-57073 | 381 | 146-69027 | 373 | 147-24135 | 99 |
| 145-73364 | 206 | 145-73970 | 220 | 145-79811 | 288 | 146-57160 | 378 | 146-69028 | 373 | 147-24140 | 99 |
| 145-73400 | 204 | 145-73971 | 220 | 145-79812 | 288 | 146-57161 | 378 | 146-69029 | 373 | 147-24141 | 99 |
| 145-73401 | 204 | 145-73972 | 220 | 145-79813 | 287 | 146-57162 | 378 | 146-69030 | 373 | 147-24142 | 96 |
| 145-73402 | 204 | 145-79040 | 285 | 145-79814 | 287 | 146-57163 | 378 | 146-69031 | 373 | 147-24143 | 97 |
| 145-73403 | 204 | 145-79041 | 285 | 145-79815 | 287 | 146-57164 | 378 | 146-69100 | 374 | 147-24144 | 96 |
| 145-73404 | 204 | 145-79042 | 285 | 145-79820 | 287 | 146-57165 | 378 | 146-69101 | 374 | 147-24145 | 97 |
| 145-73410 | 202 | 145-79050 | 285 | 145-79821 | 287 | 146-57166 | 378 | 146-69103 | 374 | 147-24150 | 100 |
| 145-73411 | 202 | 145-79051 | 285 | 145-79823 | 287 | 146-57167 | 378 | 146-69104 | 374 | 147-24151 | 100 |
| 145-73412 | 202 | 145-79052 | 285 | 145-79824 | 287 | 146-57168 | 378 | 146-69110 | 374 | 147-24162 | 100 |
| 145-73413 | 202 | 145-79053 | 285 | 145-79880 | 288 | 146-57169 | 378 | 146-69111 | 374 | 147-24163 | 100 |
| 145-73420 | 205 | 145-79060 | 285 | 145-79881 | 288 | 146-57170 | 378 | 146-69112 | 374 | 147-24200 | 102 |
| 145-73421 | 205 | 145-79061 | 285 | 146-57030 | 379 | 146-57171 | 378 | 146-69113 | 374 | 147-24210 | 102 |
| 145-73422 | 205 | 145-79062 | 285 | 146-57031 | 379 | 146-57172 | 378 | 146-69114 | 374 | 147-52100 | 156 |
| 145-73423 | 205 | 145-79063 | 285 | 146-57032 | 379 | 146-57173 | 378 | 146-69115 | 375 | 147-52101 | 156 |
| 145-73430 | 202 | 145-79070 | 285 | 146-57033 | 379 | 146-57174 | 378 | 146-69116 | 375 | 147-52110 | 156 |
| 145-73431 | 202 | 145-79071 | 285 | 146-57034 | 379 | 146-57175 | 378 | 146-69117 | 375 | 147-52111 | 156 |
| 145-73432 | 202 | 145-79072 | 285 | 146-57035 | 379 | 146-57176 | 378 | 147-02202 | 87 | 147-52120 | 153 |
| 145-73433 | 202 | 145-79073 | 285 | 146-57036 | 379 | 146-57177 | 378 | 147-02203 | 87 | 147-52121 | 153 |
| 145-73900 | 218 | 145-79700 | 284 | 146-57037 | 379 | 146-57900 | 384 | 147-02210 | 57 | 147-52510 | 154 |
| 145-73901 | 218 | 145-79701 | 284 | 146-57038 | 379 | 146-57901 | 384 | 147-22410 | 385 | 147-52511 | 154 |
| 145-73902 | 218 | 145-79702 | 284 | 146-57039 | 379 | 146-57902 | 384 | 147-22411 | 385 | 147-52513 | 154 |
| 145-73903 | 218 | 145-79703 | 284 | 146-57040 | 379 | 146-57903 | 384 | 147-22415 | 385 | 147-52520 | 154 |
| 145-73910 | 218 | 145-79704 | 284 | 146-57041 | 379 | 146-58000 | 387 | 147-22416 | 385 | 147-52521 | 154 |
| 145-73911 | 218 | 145-79705 | 284 | 146-57042 | 379 | 146-58001 | 387 | 147-22419 | 385 | 147-52523 | 154 |
| 145-73912 | 218 | 145-79706 | 284 | 146-57043 | 379 | 146-58002 | 387 | 147-22420 | 367 | 147-52530 | 152 |
| 145-73913 | 218 | 145-79707 | 284 | 146-57044 | 379 | 146-58003 | 387 | 147-22421 | 367 | 147-52531 | 152 |
| 145-73914 | 218 | 145-79708 | 284 | 146-57045 | 379 | 146-58004 | 387 | 147-22422 | 367 | 147-52532 | 152 |
| 145-73915 | 218 | 145-79709 | 284 | 146-57046 | 379 | 146-58005 | 387 | 147-22430 | 385 | 147-52533 | 152 |
| 145-73920 | 219 | 145-79710 | 284 | 146-57047 | 379 | 146-58006 | 387 | 147-22431 | 385 | 147-52534 | 152 |
| 145-73921 | 219 | 145-79711 | 284 | 146-57050 | 380 | 146-58007 | 387 | 147-22432 | 385 | 147-52535 | 152 |
| 145-73922 | 219 | 145-79712 | 284 | 146-57051 | 380 | 146-58008 | 387 | 147-22434 | 385 | 147-52540 | 153 |
| 145-73923 | 219 | 145-79713 | 284 | 146-57052 | 380 | 146-58009 | 387 | 147-22437 | 385 | 147-52541 | 153 |
| 145-73924 | 219 | 145-79714 | 284 | 146-57053 | 380 | 146-58010 | 387 | 147-24100 | 100 | 147-52630 | 155 |
| 145-73925 | 219 | 145-79715 | 284 | 146-57054 | 380 | 146-58011 | 387 | 147-24101 | 100 | 147-52631 | 155 |

INDEX

| Code | Page | Code | Page | Code | Page | Code | Page | Code | Page | Code | Page |
|-----------|------|-----------|------|-----------|------|-----------|------|-----------|------|-----------|------|
| 147-52632 | 155 | 147-53300 | 161 | 147-56021 | 351 | 147-56706 | 352 | 147-69071 | 363 | 147-76031 | 84 |
| 147-52640 | 155 | 147-53301 | 161 | 147-56022 | 351 | 147-56707 | 352 | 147-69240 | 366 | 147-76032 | 84 |
| 147-52641 | 155 | 147-53302 | 161 | 147-56023 | 351 | 147-56712 | 352 | 147-69241 | 366 | 147-76500 | 82 |
| 147-52642 | 155 | 147-53303 | 162 | 147-56060 | 353 | 147-56713 | 352 | 147-69280 | 368 | 147-76501 | 82 |
| 147-52643 | 144 | 147-53304 | 162 | 147-56061 | 353 | 147-68973 | 166 | 147-69281 | 368 | 147-76502 | 82 |
| 147-52644 | 144 | 147-53305 | 162 | 147-56062 | 353 | 147-69000 | 358 | 147-69282 | 368 | 147-76506 | 82 |
| 147-52645 | 144 | 147-53306 | 163 | 147-56063 | 353 | 147-69001 | 358 | 147-69300 | 365 | 147-76507 | 82 |
| 147-52646 | 144 | 147-53307 | 163 | 147-56064 | 353 | 147-69002 | 358 | 147-69304 | 365 | 147-76508 | 82 |
| 147-52647 | 144 | 147-53308 | 163 | 147-56065 | 353 | 147-69003 | 358 | 147-69360 | 364 | 147-76530 | 82 |
| 147-52648 | 144 | 147-53309 | 164 | 147-56070 | 353 | 147-69004 | 358 | 147-69362 | 364 | 147-76531 | 82 |
| 147-52649 | 144 | 147-53310 | 164 | 147-56071 | 353 | 147-69005 | 358 | 147-69364 | 364 | 147-76532 | 82 |
| 147-52650 | 144 | 147-53311 | 164 | 147-56072 | 353 | 147-69006 | 359 | 147-69370 | 366 | 147-76539 | 83 |
| 147-52651 | 145 | 147-53312 | 165 | 147-56073 | 353 | 147-69007 | 359 | 147-69372 | 366 | 147-76540 | 83 |
| 147-52652 | 145 | 147-53313 | 165 | 147-56078 | 353 | 147-69008 | 359 | 147-69383 | 364 | 147-76545 | 83 |
| 147-52653 | 145 | 147-53314 | 165 | 147-56079 | 353 | 147-69009 | 359 | 147-69384 | 364 | 147-76546 | 83 |
| 147-52654 | 145 | 147-55300 | 349 | 147-56321 | 376 | 147-69010 | 359 | 147-69385 | 364 | 147-76548 | 83 |
| 147-52655 | 145 | 147-55301 | 349 | 147-56322 | 376 | 147-69011 | 359 | 147-69386 | 365 | 147-76549 | 83 |
| 147-52656 | 145 | 147-55303 | 349 | 147-56550 | 350 | 147-69012 | 360 | 147-69387 | 365 | 147-76551 | 83 |
| 147-52657 | 145 | 147-55304 | 349 | 147-56551 | 350 | 147-69013 | 360 | 147-69390 | 368 | 147-76552 | 83 |
| 147-52658 | 145 | 147-55306 | 349 | 147-56553 | 350 | 147-69014 | 360 | 147-69570 | 369 | 147-76557 | 83 |
| 147-52659 | 145 | 147-55307 | 349 | 147-56554 | 350 | 147-69015 | 360 | 147-69571 | 369 | 147-76558 | 83 |
| 147-52660 | 145 | 147-55309 | 349 | 147-56556 | 350 | 147-69016 | 360 | 147-69572 | 370 | 147-76601 | 82 |
| 147-52700 | 148 | 147-55310 | 349 | 147-56557 | 350 | 147-69017 | 360 | 147-69573 | 370 | 147-77000 | 31 |
| 147-52701 | 148 | 147-55312 | 349 | 147-56560 | 350 | 147-69018 | 360 | 147-69574 | 371 | 147-77001 | 31 |
| 147-52702 | 148 | 147-55313 | 349 | 147-56561 | 350 | 147-69019 | 360 | 147-69575 | 371 | 147-77002 | 31 |
| 147-52703 | 148 | 147-55330 | 348 | 147-56562 | 350 | 147-69020 | 360 | 147-69593 | 372 | 147-77003 | 31 |
| 147-52704 | 148 | 147-55331 | 348 | 147-56563 | 350 | 147-69021 | 361 | 147-69594 | 372 | 147-77004 | 31 |
| 147-52705 | 148 | 147-55332 | 348 | 147-56564 | 350 | 147-69022 | 361 | 147-69801 | 362 | 147-77006 | 31 |
| 147-52706 | 148 | 147-55333 | 348 | 147-56565 | 350 | 147-69023 | 361 | 147-69802 | 362 | 147-77007 | 31 |
| 147-52707 | 148 | 147-55334 | 348 | 147-56610 | 352 | 147-69024 | 361 | 147-69803 | 362 | 147-77010 | 31 |
| 147-52710 | 148 | 147-55340 | 348 | 147-56611 | 352 | 147-69030 | 358 | 147-69804 | 362 | 147-77011 | 31 |
| 147-52711 | 148 | 147-55341 | 348 | 147-56613 | 352 | 147-69031 | 358 | 147-69805 | 362 | 147-77012 | 31 |
| 147-52712 | 149 | 147-55342 | 348 | 147-56614 | 352 | 147-69032 | 358 | 147-69806 | 362 | 147-77013 | 31 |
| 147-52713 | 149 | 147-55343 | 348 | 147-56616 | 352 | 147-69033 | 358 | 147-69807 | 362 | 147-77014 | 31 |
| 147-52714 | 149 | 147-55344 | 348 | 147-56617 | 352 | 147-69034 | 358 | 147-69808 | 362 | 147-77016 | 31 |
| 147-52715 | 149 | 147-55603 | 155 | 147-56640 | 354 | 147-69035 | 358 | 147-76010 | 84 | 147-77017 | 31 |
| 147-52720 | 149 | 147-55610 | 154 | 147-56642 | 354 | 147-69036 | 359 | 147-76011 | 84 | 147-77020 | 31 |
| 147-52721 | 150 | 147-55611 | 154 | 147-56644 | 354 | 147-69037 | 359 | 147-76012 | 84 | 147-77021 | 31 |
| 147-52722 | 150 | 147-55612 | 154 | 147-56653 | 354 | 147-69038 | 359 | 147-76013 | 84 | 147-77022 | 31 |
| 147-52723 | 150 | 147-55613 | 154 | 147-56654 | 354 | 147-69039 | 359 | 147-76014 | 84 | 147-77023 | 31 |
| 147-52730 | 151 | 147-55614 | 154 | 147-56656 | 354 | 147-69040 | 359 | 147-76015 | 84 | 147-77024 | 31 |
| 147-52731 | 151 | 147-55615 | 154 | 147-56657 | 354 | 147-69041 | 359 | 147-76017 | 84 | 147-77026 | 31 |
| 147-52732 | 151 | 147-55616 | 154 | 147-56660 | 355 | 147-69060 | 363 | 147-76018 | 84 | 147-77027 | 31 |
| 147-52733 | 151 | 147-55617 | 154 | 147-56661 | 355 | 147-69061 | 363 | 147-76020 | 84 | 147-77030 | 31 |
| 147-53200 | 158 | 147-55620 | 154 | 147-56662 | 355 | 147-69062 | 363 | 147-76021 | 84 | 147-77031 | 31 |
| 147-53201 | 158 | 147-55621 | 154 | 147-56670 | 355 | 147-69063 | 363 | 147-76022 | 84 | 147-77032 | 31 |
| 147-53202 | 158 | 147-55622 | 154 | 147-56671 | 355 | 147-69064 | 363 | 147-76023 | 84 | 147-77033 | 31 |
| 147-53203 | 159 | 147-55623 | 154 | 147-56675 | 355 | 147-69065 | 363 | 147-76024 | 84 | 147-77034 | 31 |
| 147-53204 | 159 | 147-55624 | 154 | 147-56676 | 355 | 147-69066 | 363 | 147-76025 | 84 | 147-77036 | 31 |
| 147-53205 | 159 | 147-55625 | 154 | 147-56682 | 393 | 147-69067 | 363 | 147-76026 | 84 | 147-77037 | 31 |
| 147-53206 | 160 | 147-55626 | 154 | 147-56683 | 393 | 147-69068 | 363 | 147-76027 | 84 | 147-77040 | 32 |
| 147-53207 | 160 | 147-55627 | 154 | 147-56684 | 393 | 147-69069 | 363 | 147-76028 | 84 | 147-77041 | 32 |
| 147-53208 | 160 | 147-56020 | 351 | 147-56685 | 393 | 147-69070 | 363 | 147-76030 | 84 | 147-77042 | 32 |

| Code | Page | Code | Page | Code | Page | Code | Page | Code | Page | Code | Page |
|-----------|------|-----------|------|-----------|------|-----------|------|-----------|------|-----------|------|
| 147-77043 | 32 | 147-77301 | 40 | 147-77468 | 35 | 147-77701 | 58 | 147-77813 | 47 | 147-77892 | 46 |
| 147-77044 | 32 | 147-77302 | 40 | 147-77500 | 42 | 147-77704 | 58 | 147-77814 | 47 | 147-77895 | 46 |
| 147-77046 | 32 | 147-77304 | 40 | 147-77501 | 42 | 147-77707 | 58 | 147-77815 | 47 | 147-77896 | 46 |
| 147-77050 | 32 | 147-77305 | 40 | 147-77502 | 42 | 147-77710 | 58 | 147-77816 | 48 | 147-77897 | 46 |
| 147-77051 | 32 | 147-77306 | 40 | 147-77510 | 54 | 147-77711 | 58 | 147-77817 | 48 | 147-77901 | 70 |
| 147-77052 | 32 | 147-77310 | 42 | 147-77520 | 73 | 147-77712 | 58 | 147-77818 | 48 | 147-77902 | 70 |
| 147-77053 | 32 | 147-77311 | 42 | 147-77551 | 78 | 147-77713 | 58 | 147-77819 | 48 | 147-77903 | 70 |
| 147-77054 | 32 | 147-77312 | 42 | 147-77552 | 78 | 147-77714 | 58 | 147-77820 | 47 | 147-77906 | 72 |
| 147-77056 | 32 | 147-77313 | 42 | 147-77560 | 79 | 147-77715 | 58 | 147-77821 | 47 | 147-78001 | 16 |
| 147-77070 | 32 | 147-77314 | 42 | 147-77561 | 79 | 147-77716 | 58 | 147-77822 | 47 | 147-78002 | 16 |
| 147-77071 | 32 | 147-77315 | 42 | 147-77562 | 79 | 147-77717 | 58 | 147-77823 | 47 | 147-78003 | 16 |
| 147-77072 | 32 | 147-77316 | 42 | 147-77563 | 79 | 147-77718 | 58 | 147-77824 | 47 | 147-78005 | 16 |
| 147-77073 | 32 | 147-77317 | 42 | 147-77564 | 79 | 147-77721 | 56 | 147-77825 | 47 | 147-78011 | 16 |
| 147-77074 | 32 | 147-77320 | 40 | 147-77566 | 79 | 147-77722 | 56 | 147-77827 | 47 | 147-78012 | 16 |
| 147-77076 | 32 | 147-77321 | 40 | 147-77568 | 79 | 147-77731 | 56 | 147-77828 | 47 | 147-78013 | 16 |
| 147-77103 | 34 | 147-77322 | 40 | 147-77570 | 79 | 147-77733 | 56 | 147-77830 | 46 | 147-78015 | 16 |
| 147-77104 | 34 | 147-77324 | 40 | 147-77570 | 396 | 147-77734 | 56 | 147-77831 | 46 | 147-78021 | 16 |
| 147-77110 | 30 | 147-77325 | 40 | 147-77571 | 79 | 147-77736 | 56 | 147-77832 | 46 | 147-78022 | 16 |
| 147-77111 | 30 | 147-77326 | 40 | 147-77571 | 396 | 147-77737 | 56 | 147-77835 | 46 | 147-78023 | 16 |
| 147-77112 | 30 | 147-77330 | 42 | 147-77572 | 396 | 147-77738 | 56 | 147-77836 | 46 | 147-78025 | 16 |
| 147-77113 | 30 | 147-77331 | 42 | 147-77573 | 396 | 147-77760 | 56 | 147-77837 | 46 | 147-78031 | 16 |
| 147-77120 | 30 | 147-77332 | 42 | 147-77575 | 79 | 147-77761 | 56 | 147-77846 | 47 | 147-78032 | 16 |
| 147-77121 | 30 | 147-77333 | 42 | 147-77575 | 396 | 147-77762 | 56 | 147-77847 | 47 | 147-78033 | 16 |
| 147-77122 | 30 | 147-77334 | 42 | 147-77600 | 52 | 147-77763 | 56 | 147-77848 | 47 | 147-78035 | 16 |
| 147-77123 | 30 | 147-77335 | 42 | 147-77601 | 52 | 147-77764 | 56 | 147-77849 | 47 | 147-78042 | 19 |
| 147-77130 | 30 | 147-77336 | 42 | 147-77602 | 52 | 147-77765 | 56 | 147-77850 | 50 | 147-78043 | 19 |
| 147-77131 | 30 | 147-77337 | 42 | 147-77603 | 52 | 147-77766 | 56 | 147-77851 | 50 | 147-78047 | 19 |
| 147-77132 | 30 | 147-77340 | 41 | 147-77604 | 52 | 147-77767 | 56 | 147-77852 | 50 | 147-78062 | 19 |
| 147-77133 | 30 | 147-77341 | 41 | 147-77605 | 52 | 147-77768 | 56 | 147-77853 | 50 | 147-78063 | 19 |
| 147-77180 | 35 | 147-77342 | 41 | 147-77624 | 53 | 147-77770 | 56 | 147-77854 | 50 | 147-78067 | 19 |
| 147-77182 | 35 | 147-77343 | 41 | 147-77625 | 53 | 147-77771 | 56 | 147-77855 | 50 | 147-78071 | 68 |
| 147-77200 | 36 | 147-77344 | 41 | 147-77626 | 53 | 147-77772 | 56 | 147-77861 | 49 | 147-78072 | 17 |
| 147-77201 | 36 | 147-77345 | 41 | 147-77627 | 53 | 147-77773 | 56 | 147-77862 | 49 | 147-78073 | 68 |
| 147-77202 | 36 | 147-77353 | 42 | 147-77628 | 53 | 147-77774 | 56 | 147-77863 | 49 | 147-78076 | 17 |
| 147-77203 | 37 | 147-77400 | 44 | 147-77629 | 53 | 147-77775 | 56 | 147-77864 | 49 | 147-78077 | 17 |
| 147-77204 | 37 | 147-77401 | 44 | 147-77640 | 52 | 147-77776 | 56 | 147-77870 | 48 | 147-78078 | 17 |
| 147-77205 | 37 | 147-77402 | 44 | 147-77641 | 52 | 147-77777 | 56 | 147-77871 | 48 | 147-78079 | 17 |
| 147-77206 | 37 | 147-77406 | 44 | 147-77642 | 52 | 147-77778 | 56 | 147-77872 | 48 | 147-78080 | 68 |
| 147-77207 | 36 | 147-77407 | 44 | 147-77645 | 52 | 147-77781 | 58 | 147-77873 | 48 | 147-78100 | 20 |
| 147-77208 | 36 | 147-77408 | 44 | 147-77646 | 52 | 147-77782 | 58 | 147-77874 | 48 | 147-78101 | 20 |
| 147-77209 | 36 | 147-77412 | 44 | 147-77647 | 52 | 147-77783 | 58 | 147-77875 | 48 | 147-78102 | 20 |
| 147-77211 | 37 | 147-77413 | 44 | 147-77650 | 54 | 147-77784 | 58 | 147-77876 | 48 | 147-78104 | 22 |
| 147-77212 | 37 | 147-77414 | 44 | 147-77651 | 54 | 147-77785 | 58 | 147-77877 | 48 | 147-78105 | 22 |
| 147-77213 | 37 | 147-77450 | 45 | 147-77652 | 54 | 147-77786 | 58 | 147-77880 | 49 | 147-78110 | 20 |
| 147-77214 | 37 | 147-77451 | 45 | 147-77656 | 53 | 147-77787 | 58 | 147-77883 | 49 | 147-78111 | 20 |
| 147-77215 | 36 | 147-77452 | 45 | 147-77657 | 53 | 147-77788 | 58 | 147-77884 | 46 | 147-78112 | 20 |
| 147-77216 | 36 | 147-77453 | 45 | 147-77658 | 53 | 147-77789 | 58 | 147-77885 | 46 | 147-78120 | 20 |
| 147-77217 | 36 | 147-77454 | 45 | 147-77681 | 78 | 147-77792 | 60 | 147-77886 | 46 | 147-78121 | 20 |
| 147-77250 | 38 | 147-77455 | 45 | 147-77684 | 78 | 147-77795 | 60 | 147-77887 | 46 | 147-78122 | 20 |
| 147-77251 | 38 | 147-77456 | 45 | 147-77691 | 54 | 147-77806 | 49 | 147-77888 | 46 | 147-78130 | 20 |
| 147-77261 | 38 | 147-77457 | 45 | 147-77692 | 54 | 147-77810 | 47 | 147-77889 | 46 | 147-78131 | 20 |
| 147-77263 | 38 | 147-77458 | 45 | 147-77696 | 54 | 147-77811 | 47 | 147-77890 | 46 | 147-78132 | 20 |
| 147-77300 | 40 | 147-77466 | 35 | 147-77697 | 54 | 147-77812 | 47 | 147-77891 | 46 | 147-78140 | 21 |

INDEX

| Code | Page | Code | Page | Code | Page | Code | Page | Code | Page | Code | Page |
|-----------|------|-----------|------|-----------|------|-----------|------|-----------|------|-----------|------|
| 147-78141 | 21 | 147-78416 | 18 | 147-80930 | 63 | 147-88061 | 90 | 153-55312 | 399 | 800-88184 | 92 |
| 147-78150 | 21 | 147-78421 | 26 | 147-80960 | 68 | 147-88062 | 90 | 153-55313 | 399 | 800-88185 | 92 |
| 147-78151 | 21 | 147-78422 | 26 | 147-80981 | 73 | 147-88063 | 90 | 153-55351 | 400 | | |
| 147-78152 | 22 | 147-78423 | 18 | 147-81823 | 63 | 147-88095 | 91 | 180-77023 | 35 | | |
| 147-78154 | 22 | 147-78424 | 18 | 147-81824 | 63 | 147-88096 | 91 | 180-77033 | 35 | | |
| 147-78160 | 21 | 147-78425 | 18 | 147-81830 | 65 | 147-88130 | 91 | 180-77720 | 57 | | |
| 147-78161 | 21 | 147-78426 | 18 | 147-81832 | 65 | 147-88131 | 91 | 180-77721 | 57 | | |
| 147-78162 | 22 | 147-78433 | 18 | 147-81890 | 67 | 147-88170 | 93 | 180-77723 | 57 | | |
| 147-78172 | 22 | 147-78434 | 18 | 147-81895 | 67 | 147-88171 | 93 | 180-77724 | 57 | | |
| 147-78173 | 20 | 147-78435 | 18 | 147-81896 | 67 | 147-88172 | 93 | 180-77726 | 57 | | |
| 147-78176 | 22 | 147-78436 | 18 | 147-81897 | 67 | 147-88173 | 93 | 180-77727 | 57 | | |
| 147-78183 | 20 | 147-78441 | 27 | 147-82800 | 76 | 147-88174 | 93 | 180-77740 | 57 | | |
| 147-78211 | 24 | 147-78451 | 26 | 147-82801 | 76 | 147-88175 | 93 | 180-77741 | 57 | | |
| 147-78212 | 24 | 147-78452 | 26 | 147-82820 | 76 | 147-88180 | 92 | 180-77742 | 57 | | |
| 147-78221 | 24 | 147-78460 | 26 | 147-82822 | 76 | 147-88181 | 92 | 180-77744 | 57 | | |
| 147-78222 | 24 | 147-78461 | 26 | 147-82823 | 76 | 147-88182 | 92 | 180-77746 | 57 | | |
| 147-78231 | 24 | 147-78471 | 26 | 147-84402 | 34 | 147-88183 | 92 | 180-77747 | 57 | | |
| 147-78232 | 24 | 147-78472 | 26 | 147-84404 | 34 | 147-88184 | 92 | 180-77748 | 57 | | |
| 147-78243 | 68 | 147-78474 | 18 | 147-84405 | 34 | 147-88185 | 92 | 180-77749 | 57 | | |
| 147-78251 | 24 | 147-78475 | 18 | 147-84406 | 34 | 147-88244 | 66 | 180-77750 | 57 | | |
| 147-78252 | 24 | 147-78480 | 27 | 147-84412 | 34 | 147-88601 | 87 | 180-77753 | 57 | | |
| 147-78253 | 25 | 147-78481 | 27 | 147-84414 | 34 | 147-88607 | 86 | 180-77756 | 57 | | |
| 147-78260 | 24 | 147-78482 | 27 | 147-84415 | 34 | 147-88610 | 86 | 180-77757 | 57 | | |
| 147-78261 | 24 | 147-78492 | 22 | 147-84416 | 34 | 147-88609 | 86 | 180-77758 | 57 | | |
| 147-78262 | 24 | 147-78497 | 22 | 147-84422 | 37 | 147-88624 | 86 | 180-80270 | 35 | | |
| 147-78263 | 25 | 147-78701 | 62 | 147-84423 | 37 | 147-88625 | 86 | 180-80272 | 35 | | |
| 147-78268 | 25 | 147-78702 | 62 | 147-84424 | 37 | 147-88626 | 86 | 180-80280 | 35 | | |
| 147-78272 | 24 | 147-78703 | 62 | 147-84425 | 37 | 147-88627 | 86 | 180-80282 | 35 | | |
| 147-78282 | 24 | 147-78721 | 64 | 147-84430 | 43 | 147-88635 | 86 | 180-80370 | 38 | | |
| 147-78291 | 24 | 147-78722 | 64 | 147-84431 | 43 | 147-88636 | 86 | 180-80372 | 38 | | |
| 147-78292 | 24 | 147-78723 | 64 | 147-84432 | 43 | 147-88637 | 86 | 180-80460 | 43 | | |
| 147-78305 | 16 | 147-78724 | 64 | 147-84433 | 43 | 147-88638 | 86 | 180-80461 | 43 | | |
| 147-78306 | 16 | 147-78730 | 66 | 147-84440 | 43 | 147-88640 | 86 | 200-57810 | 382 | | |
| 147-78307 | 16 | 147-78731 | 66 | 147-84441 | 43 | 147-99804 | 12 | 200-57811 | 382 | | |
| 147-78308 | 16 | 147-78735 | 66 | 147-84442 | 43 | 147-99807 | 12 | 200-57812 | 382 | | |
| 147-78310 | 16 | 147-78760 | 62 | 147-84443 | 43 | 147-99812 | 12 | 200-57813 | 382 | | |
| 147-78311 | 16 | 147-78765 | 62 | 147-84573 | 79 | 147-99812 | 13 | 200-57816 | 383 | | |
| 147-78312 | 16 | 147-78770 | 63 | 147-84608 | 52 | 147-99831 | 13 | 200-57818 | 383 | | |
| 147-78313 | 16 | 147-78771 | 63 | 147-84610 | 52 | 147-99833 | 13 | 800-84654 | 54 | | |
| 147-78324 | 20 | 147-78990 | 72 | 147-84611 | 52 | 147-99834 | 12 | 800-84655 | 54 | | |
| 147-78327 | 20 | 147-79011 | 17 | 147-84931 | 72 | 147-99835 | 12 | 800-88094 | 91 | | |
| 147-78346 | 27 | 147-79012 | 17 | 147-84932 | 74 | 147-99843 | 13 | 800-88095 | 91 | | |
| 147-78351 | 27 | 147-79023 | 34 | 147-84936 | 71 | 147-99844 | 13 | 800-88160 | 93 | | |
| 147-78366 | 26 | 147-79024 | 34 | 147-84940 | 73 | 153-55300 | 398 | 800-88170 | 93 | | |
| 147-78368 | 26 | 147-79025 | 34 | 147-86011 | 88 | 153-55301 | 398 | 800-88171 | 93 | | |
| 147-78371 | 26 | 147-79103 | 21 | 147-86013 | 88 | 153-55302 | 398 | 800-88172 | 93 | | |
| 147-78373 | 26 | 147-79111 | 21 | 147-86015 | 88 | 153-55303 | 398 | 800-88173 | 93 | | |
| 147-78388 | 26 | 147-79123 | 37 | 147-86021 | 88 | 153-55305 | 398 | 800-88174 | 93 | | |
| 147-78393 | 26 | 147-79124 | 37 | 147-86022 | 88 | 153-55306 | 398 | 800-88175 | 93 | | |
| 147-78411 | 27 | 147-79125 | 37 | 147-86024 | 88 | 153-55307 | 398 | 800-88180 | 92 | | |
| 147-78413 | 18 | 147-79452 | 45 | 147-86121 | 89 | 153-55308 | 398 | 800-88181 | 92 | | |
| 147-78414 | 18 | 147-79455 | 45 | 147-86131 | 89 | 153-55310 | 399 | 800-88182 | 92 | | |
| 147-78415 | 18 | 147-79815 | 48 | 147-86132 | 89 | 153-55311 | 399 | 800-88183 | 92 | | |



SHOP & FOLLOW

EUROLAMP®

EUROLAMP S.A.

3rd km Symmachiki road, 57013 Oreokastro
Thessaloniki, Greece

T. +30 2310 574802, F. +30 2310 574919

E. info@eurolamp.gr

eurolamp.gr

Lighting & Bulbs COLLECTION