

**rabalux<sup>®</sup>**

# OUTDOOR LIGHTS

**2026**

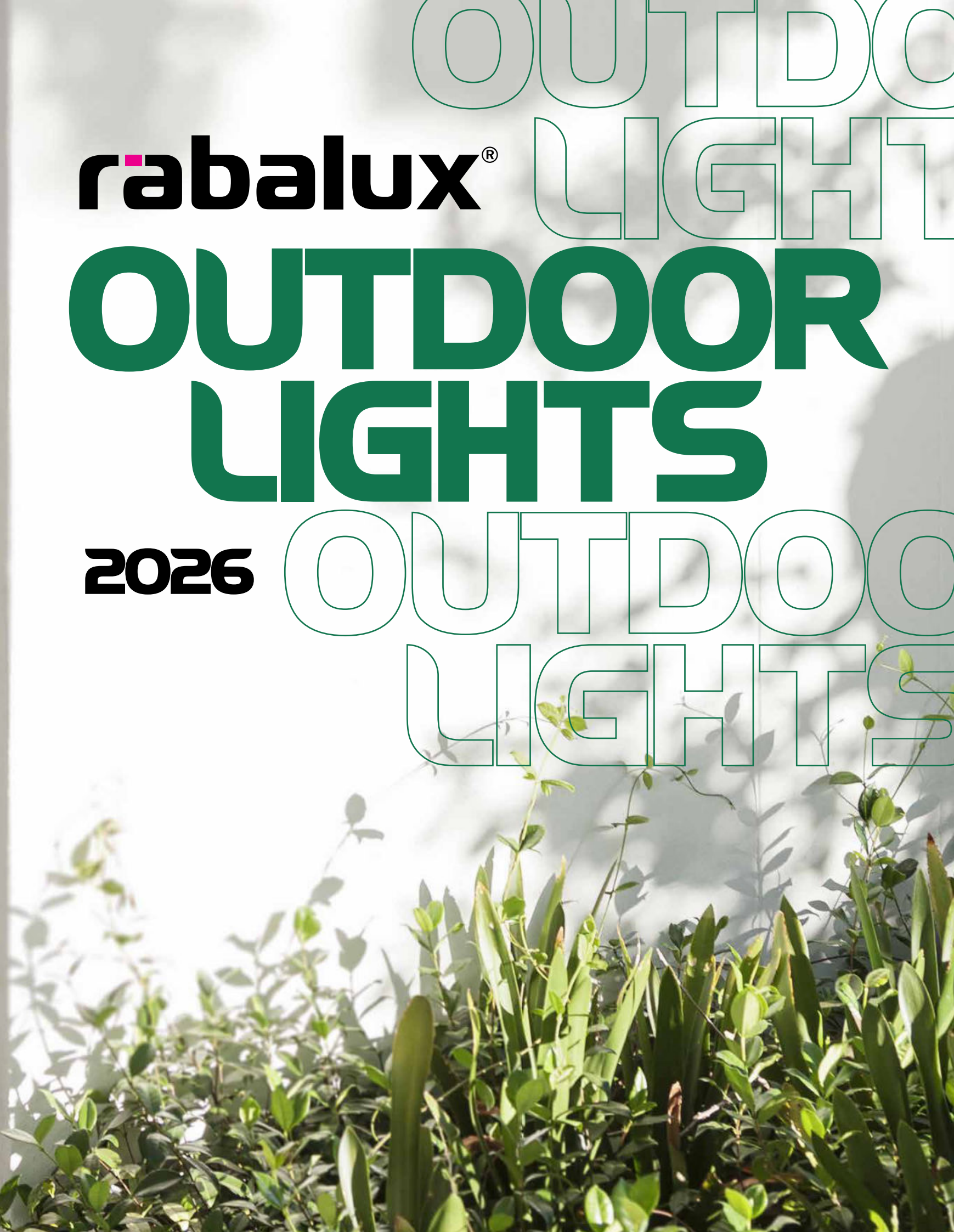



# WELCOME • ÜDVÖZÖLJÜK • WILLKOMMEN

## DEAR PARTNER AND CUSTOMER!



We believe that home doesn't end within four walls: your garden, terrace, balcony, or entrance deserves stylish, well-planned lighting just as much. Outdoor lighting is not only practical — it creates atmosphere, adds a sense of safety, and makes evening moments truly come alive.

We are delighted to present our new outdoor catalogue, where you can choose from our new modern, energy-efficient lights as well as our timeless classic favourites.

**Get inspired and bring light to your own outdoor stories! Enjoy browsing!**

## KEDVES PARTNEREINK ÉS VÁSÁRLÓINK!



Hiszünk benne, hogy az otthon nem ér véget a négy falnál: a kert, a terasz, az erkély vagy a bejárat ugyanúgy megérdemli a stílusos, jól megtervezett fényt. A kültéri világítás nemcsak praktikus, hanem hangulatot teremt, biztonságot ad, és igazán élővé teszi az esti pillanatokat.

Örömmel mutatjuk be idei kültéri katalógusunkat, amelyben új modern, energiatakarékos lámpáink mellett időtálló klasszikus lámpáink között válogathatsz!

**Inspirálódj, és teremts fényt a saját kinti történeteidhez! Kellemes böngészést kívánunk!**

## SEHR GEEHRTE PARTNER UND KUNDEN!



Wir sind überzeugt, dass das Zuhause nicht an den vier Wänden endet: Garten, Terrasse, Balkon oder Eingangsbereich verdienen ebenso stilvolles, gut geplantes Licht. Außenbeleuchtung ist nicht nur praktisch – sie schafft Atmosphäre, sorgt für Sicherheit und lässt die Abende wirklich lebendig werden.

Mit Freude präsentieren wir unseren diesjährigen Außenleuchtenkatalog, in dem du neben unseren neuen modernen, energieeffizienten Leuchten auch aus zeitlosen Klassikern wählen kannst.

**Lass dich inspirieren und bring Licht in deine eigenen Outdoor-Geschichten! Viel Freude beim durchblättern!**



# CONTACT • ELÉRHETŐSÉGEK • KONTAKT

## CENTRE/KÖZPONT/ZENTRALE



### MAGYARORSZÁG/HUNGARY

RÁBALUX HEAD OFFICE  
RÁBALUX VILÁGÍTÁSTECHNIKA ZRT.  
VILÁGÍTÁSTECHNIKA GYÁRTÁS ÉS FORGALMAZÁS/  
LIGHTING PRODUCTION AND DISTRIBUTION

H-9027 Győr, Körtefa u. 5.  
Tel.: +36 96 526 716  
E-mail: info@rabalux.com  
www.rabalux.com

## AFFILIATES/LEÁNYVÁLLALATOK/ZWEIGSTELLEN



### BULGARIA

РАБАЛУКС ЕООД / RABALUX EOOD  
ул. "Андрей Николов" №15,  
1111 София,  
България  
Тел./Факс: +359 2 936 00 97  
E-mail: infobg@rabalux.com  
www.rabalux.bg



### CROATIA, BOSNIA HERZEGOVINA, MONTENEGRO



RABALUX RASVJETA d.o.o.  
Ulica grada Gospića 1a  
10000 Zagreb  
Tel.: +385 1 652 80 66  
E-mail: infocro@rabalux.com  
www.rabalux.hr



### CZECH REPUBLIC

RABALUX CZ Svítidla s.r.o.  
Kaštanová 141/a, 617 00 Brno,  
Česká Republika  
Tel.: +420 739 665 322  
E-mail: infocz@rabalux.com  
www.rabalux.cz



### HUNGARY

Rábalux Magyarország Kft.  
Magyarország  
H-9027 Győr,  
Körtefa u. 5.  
Tel.: +36 96 526 716  
E-mail: infohu@rabalux.com  
www.rabalux.hu



### POLAND

Rabalux Sp. z o.o.  
ul. Sołtysia 119, 40-750 Katowice,  
Polska  
Tel.: +48 32 254 61 34  
E-mail: infopl@rabalux.com  
zamowienia@rabalux.com  
www.rabalux.pl



### ROMANIA

SC RABALUX SRL  
Cluj-Napoca, str. Fabricii,  
nr. 93-103, jud. CLUJ  
Romania  
cod postal: 400632  
Tel.: +40 264 456 040  
E-mail: infofo@rabalux.com  
www.rabalux.ro



### SERBIA, NORTHERN MACEDONIA



Rabalux SRB d.o.o.  
Autoput za Zagreb 20.  
11080 Beograd –  
Zemun, Srbija  
Mob: + 381 60 444 3977;  
Tel.: +381(0)11 2013 986  
E-mail: infosrb@rabalux.com  
www.rabalux.rs



### SLOVAKIA

RABALUX SK. Svetídlá, s.r.o.  
Alžbetínske nám. 328,  
929 01 Dunajská Streda,  
Slovenská Republika  
Tel.: +421 31 551 54 04  
E-mail: infosk@rabalux.com  
www.rabalux.sk



### UKRAINE

ТОВ Рабалукс,  
вул. Рилєєва 4, м. Ужгород,  
Україна, 88017  
моб.тел.: +38 067 310 05 20  
E-mail: infoua@rabalux.com  
www.rabalux.ua

## OFFICIAL RESELLERS/MEGBÍZOTT VISZONTELDŐK/BEAUFTRAGTE WIEDERVERKÄUFER



### GERMANY

Sinnocon GmbH  
01156 Dresden,  
Breitscheidstr. 45  
Tel.: +49 351 65335641  
E-mail: rabalux@sinnocon.de  
www.sinnocon.de



### SLOVENIA

Lagea d.o.o.  
Brezina 19c  
8250 Brežice  
Republika Slovenija  
Tel.: +386 70 292 70 20  
E-mail: elmatis@lagea.si



### GREECE

ANASTASIADI SA  
1km Katerini-Ganohora Road,  
Katerini, 60100  
Tel.: +30 2351039757  
E-mail: eshop@anastasiadi.gr  
www.anastasiadi.gr



### GREECE

S.MELISSOURGOS CO OE  
8 Kourtiou St,  
11146 Galatsi,  
Tel.: +0030 2102136040  
E-mail: info@melissourgos.com.gr  
www.melissourgos.com.gr



### PORTUGAL

STORM LIGHT,LDA  
Rua António Pereira Vidal Xavier nº,  
3750-802 Valongo do Vouga,  
Tel.: 234 661 068  
E-mail: geral@storm-light.pt  
www.storm-light.pt



### SPAIN

Buyled Led Lighting S.L  
03007, Alicante,  
ES, C/Gillen de Castro 1  
Tel.: +0034 633460731  
E-mail: info@buyled.es  
www.buyled.es



### ITALY

Fra.Co.Distribuzione Srl  
Sp1 km24,  
90047 Partinico (PA)  
Tel.: 0039 0915071547  
E-mail: info@fracodistribuzione.it  
www.fracodistribuzione.it



### FINLAND

Focus Interiors Oy  
Kuusipolku 35,  
37150 Nokia  
Tel.: +358 (0)10 3270 520  
E-mail: info@focusinteriors.fi  
www.focusinteriors.fi



### ALBANIA

FAAM Light sh.p.k.  
Rruga Muhedin Llagani,  
Kompleksi Square 21,  
Tirana, Albania  
Tel.: +355 67 446 6888  
E-mail: info@faamlight.al  
www.faamlight.al



### UNITED KINGDOM

Lighting Direct  
24-26 Vincent Ave,  
Crownhill, Milton Keynes  
Buckinghamshire, MK8 0AB  
E-mail: customerservice@lighting-direct.co.uk  
www.lighting-direct.co.uk



### ESTONIA

Lambipesa OÜ  
Tel.: +372 5124235  
E-mail: eve@lambipesa.ee  
www.lambipesa.ee



### LITHUANIA, LATVIA

UAB LEDOK  
Birutes str. 2,  
Klaipėda 91200, Lithuania  
Tel.: +37062068111  
E-mail: B2B@ledok.lt  
www.ledok.lt

# CONTACT • ELÉRHETŐSÉGEK • KONTAKT

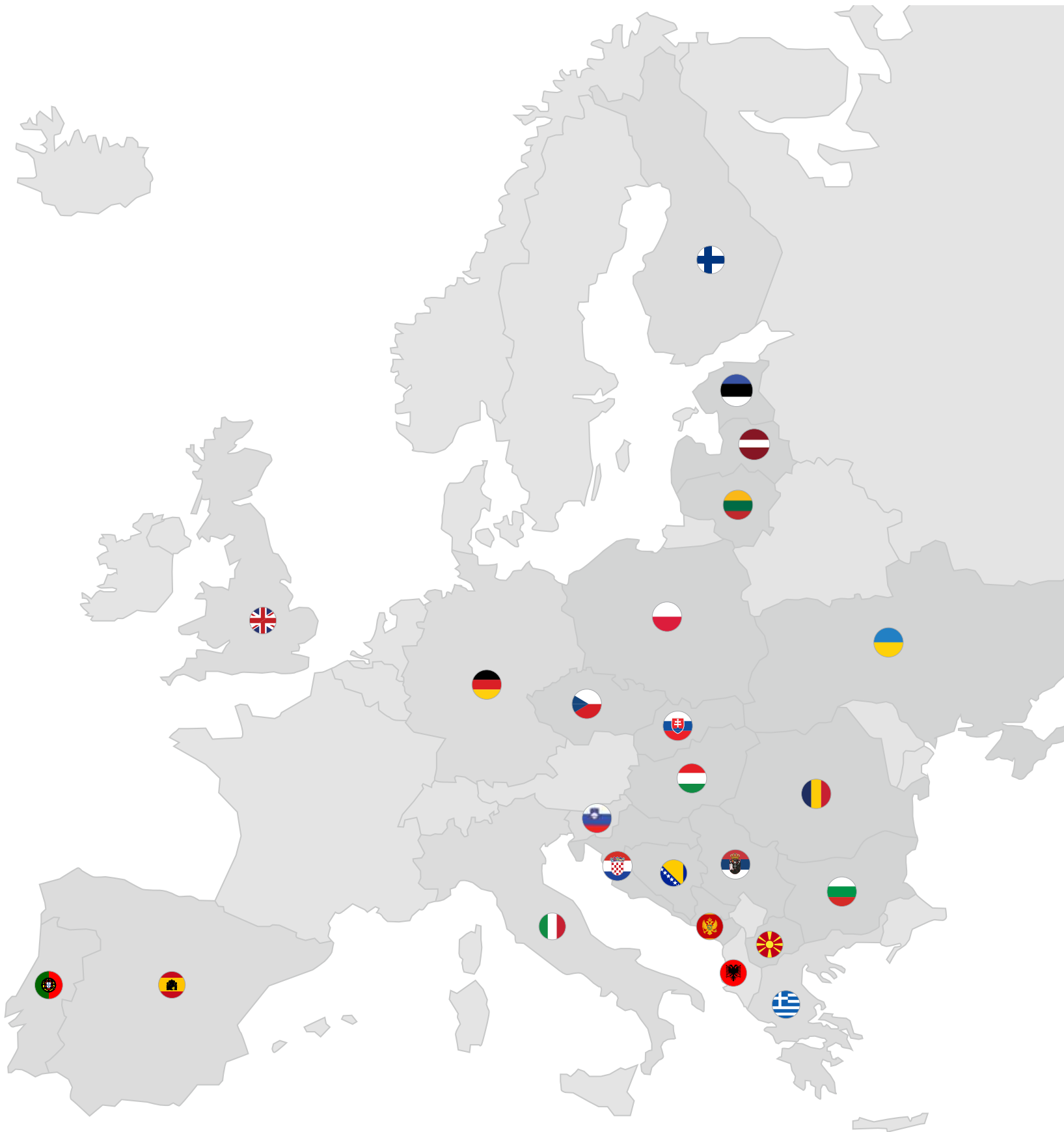





We know that choosing the right outdoor light is a complex decision: colour temperature, beam direction and spread, energy efficiency, and how the fixture fits its surroundings are all key factors.

That's why our this year's outdoor collection offers even more universal, flexible solutions. Several models feature adjustable beam angles and selectable colour temperatures, so the lighting can be finely tuned to the space and your needs — even after installation. With modern, energy-efficient technologies and versatile mounting options, planning becomes simpler while the result always delivers the exact effect you want.

**Turn the page and discover our new outdoor collection!**



Jól tudjuk, hogy a megfelelő kültéri lámpa kiválasztása összetett döntés: a színhőmérséklet, a fény iránya és szórása, az energiatakarékosság, valamint a környezethez való illeszkedés mind fontos szempont.

Ezért az idei kültéri kollekciókban még több univerzális, rugalmasan alkalmazható megoldást kínálunk. Több modellnél állítható a fény vetítési szöge és a színhőmérséklet, így a világítás az adott térhez és igényekhez finoman hangolható — akár a felszerelés után is. Modern, energiatakarékos technológiáinkkal és variálható telepítési lehetőségeinkkel a tervezés egyszerűbb, az eredmény pedig mindig pontosan a kívánt hatást adja.

**Lapozz tovább, és fedezd fel az új kültéri kollekciókat!**



Wir wissen, dass die Auswahl der passenden Außenleuchte eine komplexe Entscheidung ist: Farbtemperatur, Lichtausrichtung und -streuung, Energieeffizienz sowie die harmonische Integration in die Umgebung spielen dabei eine zentrale Rolle.

Deshalb bietet unsere diesjährige Außenleuchtenkollektion noch mehr universal einsetzbare, flexible Lösungen. Bei mehreren Modellen lassen sich der Abstrahlwinkel und die Farbtemperatur einstellen, sodass die Beleuchtung exakt auf den jeweiligen Bereich und die individuellen Anforderungen abgestimmt werden kann — auch nach der Montage. Mit modernen, energieeffizienten Technologien und variablen Montagemöglichkeiten wird die Planung einfacher, und das Ergebnis erzielt stets die gewünschte Lichtwirkung.

**Blättere weiter und entdecke unsere neue Außenleuchten!**







# CONTENTS • TARTALOMJEGYZÉK • INHALTSVERZEICHNIS

## 01

### MODERN PRODUCT FAMILIES

Modern  
termékcsaládok

Moderne  
Produktfamilien

24-53

## 02

### WALL AND CEILING LAMPS

Fali- és  
mennyezetlámpák

Wand- und  
Deckenlampen

54-127

## 03

### CLASSIC PRODUCT FAMILIES

Klasszikus  
termékcsaládok

Klassische  
Produktfamilien

128-147

## 04

### TABLE, DECORATIVE, AND SOLAR LAMPS

Asztali, dekor. és  
napelemes lámpák

Tisch-, Dekor- und  
Solarlampen

148-173



MODERN PRODUCT FAMILIES



**TAMARITE**  
77206  
26



**TAMARITE**  
77207  
26



**CUBBINGTON**  
77183  
27



**CUBBINGTON**  
77184  
27



**CUBBINGTON**  
77185  
27



**TELDE**  
77101  
28



**TELDE**  
77102  
28



**MEDNA**  
77103  
28



**MEDNA**  
77104  
28



**CERNON**  
77054  
29



**CERNON**  
77055  
29



**CERNON**  
77056  
29



**ODIEL**  
77057  
30



**ODIEL**  
77058  
30



**ODIEL**  
77059  
30



**ODIEL**  
77060  
30



**WENGEN**  
77148  
31



**WENGEN**  
77149  
31



**PALANGA**  
7504  
32



**PALANGA**  
7505  
32



**PALANGA**  
7506  
32



**TOLNA**  
77171  
33



**TOLNA**  
77172  
33



**TOLNA**  
77173  
33



**DARVAS**  
77126  
34



**DARVAS**  
77127  
34



**DARVAS**  
77128  
34



**LEITHA**  
77130  
35



**LEITHA**  
77131  
35



**LEITHA**  
77132  
35



**ENOL**  
77110  
36



**ENOL**  
77111  
36



**ENOL**  
77112  
36



**ENOL**  
77113  
36



**ELVA**  
7929  
37



**ELVA**  
7930  
37



**BELFAST**  
7904  
37



**GORDES**  
77193  
37



**TORNIO**  
77071  
38



**TORNIO**  
77072  
38



**ANKARA**  
7380  
39



**ANKARA**  
7379  
39



**ANKARA**  
77026  
39



**ANKARA**  
77025  
39



**ANKARA**  
77122  
39



**LOANDA**  
77080  
40



**LOANDA**  
77081  
40



**LOANDA**  
77082  
40



**TEPLICE**  
7158  
41



**TEPLICE**  
7159  
41



**TARPA**  
77106  
42



**TARPA**  
77107  
42



**TARPA**  
77108  
42



**BUDAPEST**  
8888  
43



**BUDAPEST**  
8889  
43



**BUDAPEST**  
8890  
43



**ALMADA**  
7884  
44



**ALMADA**  
7885  
44



**PARAVENTO**  
7146  
45



**PARAVENTO**  
7147  
45



**PARAVENTO**  
7149  
45



**PARAVENTO**  
7150  
45



**TAVERNA**  
7127  
46



**TAVERNA**  
7128  
46



**TAVERNA**  
7129  
46



**TAVERNA**  
7130  
46



**DUBROVNIK**  
7238  
47



**DUBROVNIK**  
7239  
47



**DUBROVNIK**  
7240  
47



**BLACKTORCH**  
8145  
48



**BLACKTORCH**  
8146  
48



**BLACKTORCH**  
8147  
48



**BLACKTORCH**  
8148  
48



**BONN**  
8337  
49



**BONN**  
8338  
49



**BONN**  
8339  
49



**INOXTORCH**  
8261  
50



**INOXTORCH**  
8263  
50



**INOXTORCH**  
8264  
50



**INOXTORCH**  
8265  
51



**INOXTORCH**  
8266  
51



**INOXTORCH**  
8267  
51



**INOXTORCH**  
8268  
51



**LISBON**  
7826  
52



LISBON  
7827  
52



LISBON  
7828  
52



LISBON  
7829  
52

WALL AND CEILING LAMPS



MODANE  
75069  
56



MODANE  
75070  
56



KELEBIA  
77125  
58



ZILINA  
77052, 77053  
59



KIONI  
77063  
60



PEMBA  
77077  
61



TILBURG  
77049  
62



TILBURG  
77050  
62



TEMSE  
77065  
63



TEMSE  
77066  
63

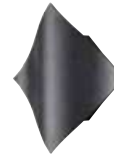

NAVIA  
8130  
63



FOLLINA  
8154  
63



RUST  
77151  
64



RUST  
77152  
64



RUST  
77153  
64



GERLA  
77178  
65



GERLA  
77179  
65



GERLA  
77180  
65



BRADU  
77067  
66



BRADU  
77068  
66



HALLSTATT  
77168  
67



HALLSTATT  
77169  
67



HALLSTATT  
77170  
67



SOLIN  
7396  
68



SOLIN  
7397  
68



PORTEL  
77191  
68



PORTEL  
77192  
68



LIPPA  
7317  
69



LIPPA  
7318  
69



LIPPA  
7319  
69



LIPPA  
7320  
69



MARIBOR  
8873  
70



MARIBOR  
8874  
70



MATARO  
77073  
71



MATARO  
77074  
71



MATARO  
77075  
71



MATARO  
77076  
71



NESNA  
7951  
72



NESNA  
7952  
72



KOBARID  
77174  
73



MATARO  
77114  
73



IBAR  
87109  
73



OPOLE  
7797  
74



LUBLIN  
77099  
74

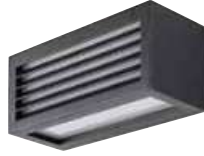

LUBLIN  
77100  
74



BIRMINGHAM  
8795  
75



RENNES  
77042  
75



RODEZ  
8940  
75



GIMONE  
77097  
76



GIMONE  
77098  
76



ANDELLE  
77095  
76



ANDELLE  
77096  
76



BALIMO  
7476  
77



BALIMO  
7477  
77



BALIMO  
7478  
77



BALIMO  
7479  
77



ZARAGOZA  
77092  
78



ZARAGOZA  
77093  
78



ZARAGOZA  
77115  
78



ZARAGOZA  
77116  
78



BATIDA  
77117  
79



BATIDA  
77118  
79



BATIDA  
77119  
79



BATIDA  
77120  
79



VARNA  
8134  
80



VARNA  
8135  
80



HALDEN  
7935  
80



SENICA  
77064  
81



LAXA  
77121  
81



RAPLA2  
77150  
81



URFA  
77154  
82



URFA  
77155  
82



URFA  
77156  
82



URFA  
77157  
82



URFA  
77161  
83



URFA  
77162  
83



URFA  
77163  
83



URFA  
77164  
83



URFA LINE  
77209  
84



URFA LINE  
77210  
84



URFA LINE  
77211  
84



URFA LINE  
77212  
84



SINTRÁ  
7955  
85



SINTRÁ  
7956  
85



BUFFALO  
7887  
85



BUFFALO  
7888  
85



MEDINA  
8832  
86



MEDINA  
8833  
86



MEDINA  
8834  
86



MEDINA  
8835  
86



CHILE  
8029  
87



CHILE  
8030  
87



CHILE  
8018  
87



CHILE  
8019  
87



MANDAL  
7959  
88



MANDAL  
7960  
88



PHOENIX  
8118  
88



PHOENIX  
8119  
88



WELLINGTON  
7502  
89



KOLTA  
7386  
89



NOVIGRAD  
7236  
90



NOVIGRAD  
7237  
90



SILISTRA  
7891  
90



SILISTRA  
7892  
90



ZERNEST  
77085  
91



ZERNEST  
77086  
91



ZATON  
7070  
91



ROMA  
8409  
92



ROMA  
8410  
92



ROMA  
8511  
92



ROMA  
8776  
92



DURANGO  
8766  
93



DURANGO  
8767  
93



SEVILLA  
8799  
93



SEVILLA  
8800  
93



ORLOVA  
7244  
93



ZOMBOR  
7817  
94



ZOMBOR  
7818  
94



ZOMBOR  
7819  
94



ZOMBOR  
7820  
94



AKRON  
8149  
95



AKRON  
8150  
95



KOVEN  
71342  
95



KOVEN  
71343  
95



DOLEN  
75067, 75068  
96



DOLEN  
75065, 75066  
97



MAUREC  
75080  
98



MAUREC  
75081  
98



MAUREC  
75082  
98



LAUTREC  
75083  
99



LAUTREC  
75084  
99



LAUTREC  
75085  
99



INVERNESS  
7774  
101



INVERNESS  
7775  
101



ALENZO  
71431  
101



ALENZO  
71441  
101



INDRE  
77035  
102



INDRE  
77036  
102



PERNIK  
7250  
103



PERNIK  
7265  
103



TARTU  
7893, 7894  
104



TARTU  
7897, 7898  
104



TARTU  
7895, 7896  
104



TARTU  
7899, 7900  
104



ALENZO  
71425, 71426, 71427, 71429  
106



ALENZO  
71435, 71436, 71437, 71439  
106



ALENZO  
71422, 71423  
107



ALENZO  
71432, 71433  
107



ALENZO  
71428, 71430  
108



ALENZO  
71438, 71440  
108



ALENZO  
71424  
108



ALENZO  
71434  
108



SAMIRA  
71252, 71253, 71254  
110



SAMIRA  
71257, 71258, 71259  
110



SAMIRA  
71255, 71256  
111



SAMIRA  
71260, 71261  
111



LOWAR  
77133, 77135, 77182  
112



LOWAR  
77134, 77136, 77181  
112



LUCAS  
3437, 3438, 3439  
114



LUCAS 2  
71504, 71505, 71506  
114



LUCAS 2  
71510, 71511, 71512  
114



ERIC  
7979  
115



GAELO  
75025, 75026  
115



ZENON  
2697, 2698  
115



LARCIA  
75009  
116



LARCIA  
75010  
116



STUTTART  
8683  
117



STUTTART  
8684  
117



STUTTART  
8685  
117



SHAUN PLUS  
75071, 75072, 75073  
118



SHAUN PLUS  
75074, 75075, 75076  
118



SHAUN PLUS  
75077, 75078, 75079  
118



LARCIA  
75011  
121



LARCIA  
75012  
121



LUCAS  
71132, 71133, 71134  
121



LOWAR  
77137, 77138  
122



LOWAR  
77139, 77140  
122



LONATO  
77213  
124



LONATO  
77214  
124



HITURA  
77028  
124



HITURA  
77029  
124



HORT  
7406  
125



HORT  
7407  
125



HORT  
7408  
125



HORT  
7409  
125



LENTIL  
5810  
125



AMARILLO  
7969  
126



AMARILLO  
7980  
126



TRENTO  
8893  
126



TRENTO  
8894  
126



TRENTO  
77105  
126



KAVALA  
77189  
127



KAVALA  
77190  
127



PUEBLO  
8011  
127



TACOMA  
8714  
127

CLASSIC PRODUCT FAMILIES



MONACO  
8181  
130



MONACO  
8182  
130



MONACO  
8184  
130



MONACO  
8185  
130



MONACO  
8186  
130



TORONTO  
8381  
131



**TORONTO**  
8460  
131



**MILANO**  
8370  
132



**MILANO**  
8371  
132



**MILANO**  
8372  
132



**MILANO**  
8376  
132



**MILANO**  
8373  
133



**MILANO**  
8374  
133



**MILANO**  
8375  
133



**MILANO**  
7837  
134



**MILANO**  
8341  
134



**MILANO**  
8342  
134



**MILANO**  
8344  
134



**MILANO**  
8345  
134



**MILANO**  
8346  
134



**VELENCE**  
8202  
135



**VELENCE**  
8204  
135



**VELENCE**  
8206  
135



**VELENCE**  
8208  
135



**VELENCE**  
8210  
135



**VELENCE**  
8217  
135



**VELENCE**  
8201  
136



**VELENCE**  
8203  
136



**VELENCE**  
8205  
136



**VELENCE**  
8207  
136



**VELENCE**  
8209  
136



**VELENCE**  
8216  
136



**VELENCE**  
8218  
137



**VELENCE**  
8232  
137



**VELENCE**  
8234  
137



**VELENCE**  
8236  
137



**VELENCE**  
8238  
137



**VELENCE**  
8240  
137



**TOSCANA**  
8391  
138



**TOSCANA**  
8392  
138



**TOSCANA**  
8394  
138



**TOSCANA**  
8395  
138



**ODESSA**  
8163  
139



**ODESSA**  
8164  
139



**ODESSA**  
8165  
139



**MADRID**  
7836  
140



**MADRID**  
8377  
140



**MADRID**  
8476  
140



**MADRID**  
8379  
141



**MADRID**  
8480  
141



**OSLO**  
8271  
142



**OSLO**  
8681  
142



**OSLO**  
8736  
142



**OSLO**  
8737  
142



**OSLO**  
8739  
142



**OSLO**  
8740  
142



**OSLO**  
8270  
143



**OSLO**  
8763  
143



**OSLO**  
8764  
143



**YAGO**  
3309  
143



**OSLO**  
8680  
144



**OSLO**  
8682  
144



**OSLO**  
8716  
144



**OSLO**  
8717  
144



**VIGO**  
8686  
145



**VIGO**  
8687  
145



**DARIUS**  
8190  
146



**HEKTOR**  
8496  
146



**HEKTOR**  
8499  
146



**HAGA**  
8244  
147



**NORVICH**  
8753  
147



**NORVICH**  
8754  
147

TABLE, DECORATIVE AND SOLAR LAMPS



**POLPERRO**  
77146  
150



**POLPERRO**  
77147  
150



**MIREO**  
76036  
151



**MIREO**  
76037  
151



**MIREO**  
76038  
151



**MIREO**  
76039  
151



**FUNES**  
77143  
152



**FUNES**  
77144  
152



**FUNES**  
77145  
152



**ODERA**  
7040  
153



**BURDUR**  
77142  
153



**ALASKA**  
77017  
155



**ALASKA**  
77018  
155



**LASSET**  
77078  
155



**LASSET**  
77079  
155



**MOSELLE**  
77014  
156

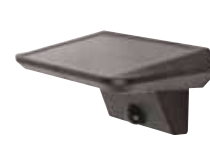

**QESA**  
77005  
156



**KANGTON**  
77024  
156



**LERMOS**  
77203  
156



**NARMADA**  
77004  
156



**SEPIK**  
77013  
157



**KAPUAS**  
77015  
157



**BREZNO**  
77006  
157



**LUTTO**  
77030  
157



**MONTORO**  
77205  
158



**ISPRA**  
77166  
158



**OSTRAVA**  
7880  
159



**OSTRAVA**  
7881  
159



**OPAVA**  
7970  
159



**TARCAL**  
77159  
160



**TARCAL**  
77160  
160



**FLAXTON**  
77040  
161



**FLAXTON**  
77090  
161



**LIHULL**  
77020  
162



**MELK**  
77141  
163



**VALPOVO**  
77019  
163



**ZAVOD**  
77129  
163



**ZLARIN**  
77012  
163



**SAVOCA**  
77167  
164



**YOLA**  
7850  
164



**TAPOLCA**  
77176  
164



**SLUIS**  
77046  
164



**TRILLO**  
77175  
165



**HOLNE**  
77188  
165

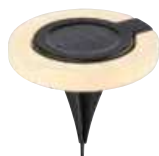

**BOKOD**  
77187  
165

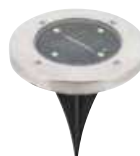

**DANNET**  
7975  
165



**MORA**  
8948  
166



**MORA**  
8949  
166



**KROBIA**  
7814  
167



**TURDA**  
7060  
167



**NANTES**  
77088  
167



**KELNA**  
77011  
167



**CONG**  
77186  
168



**FUNGHETTO**  
7877  
168



**RAVELLO**  
77158  
168



**MONOR**  
77177  
169



**SOLAR1**  
8365  
169



**SOLAR1**  
8366  
169



**TAVIRA**  
77043  
170



**ZIRC**  
77165  
170



**WIGRY**  
77001  
171

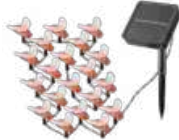

**BOBUS**  
77002  
171



**ANSOO**  
77016  
172



**BIRI**  
77123, 77124  
172



**LED STRIP**  
79021  
173



**LED STRIP**  
79022, 79023  
173

---



Our new products are marked with magenta.  
Új termékeink magenta színnel jelölve.  
Unsere neuen Produkte sind mit Magenta gekennzeichnet.

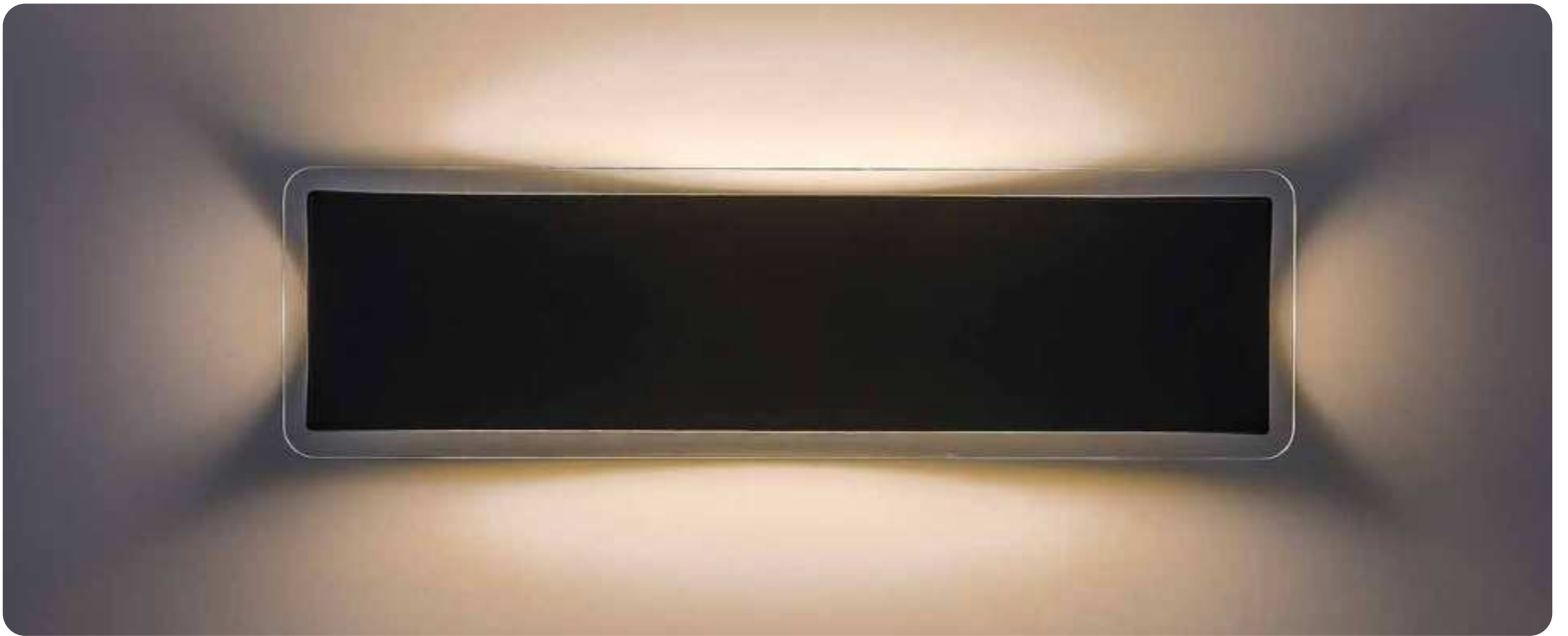



**01**

**MODERN PRODUCT FAMILIES**

**MODERN TERMÉKCSALÁDOK**

**MODERNE PRODUKTFAMILIEN**



# TAMARITE



77206

65mm

180mm

115mm

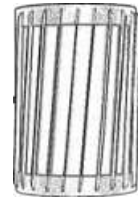

77207

610mm

Ø 195mm



77206 (M) (P)

LED / 6W  
(390lm, 825lm;  
4000K) incl. • IP54  
anthracite/white



5 996595 772062

77207 (M) (P)

LED / 12W  
(800lm, 1690lm;  
4000K) incl. • IP54  
anthracite/white



5 996595 772079

# CUBBINGTON



77183

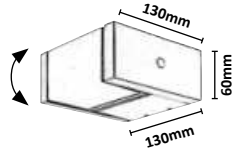

77185

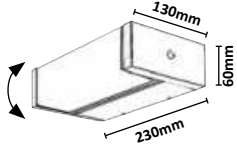

77184

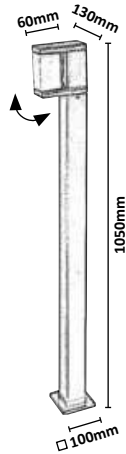

**77183** (M) (P)

LED / 10W  
(720lm, 1200lm;  
4000K) incl. • IP54  
black/white



5 996595 771836

**77184** (M) (P)

LED / 10W  
(740lm, 1200lm;  
4000K) incl. • IP54  
black/white



5 996595 771843

**77185** (M) (P)

LED / 18W  
(1460lm, 2200lm;  
4000K) incl. • IP54  
black/white



5 996595 771850



## TELDE



77101

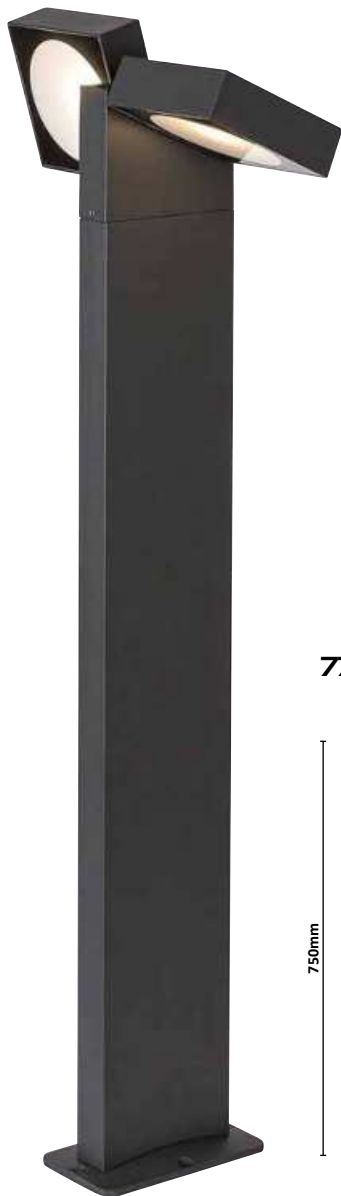
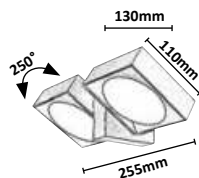

77102

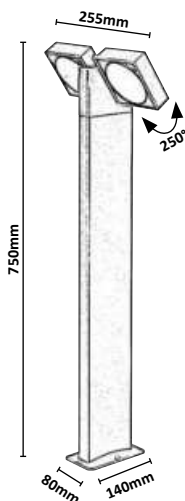

## MEDNA



77103

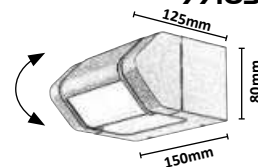

77104

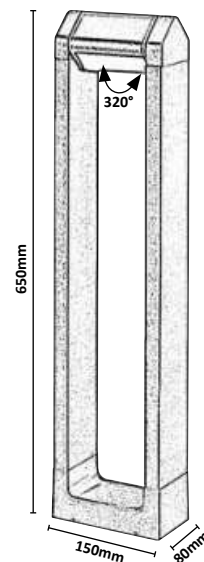

77101 (M) (G)

LED / 14W  
 (900lm, 1620lm;  
 3000K) incl. • IP54  
 anthracite/transparent



5 996595 771010

77102 (M) (G)

LED / 14W  
 (900lm, 1620lm;  
 3000K) incl. • IP54  
 anthracite/transparent



5 996595 771027

77103 (M) (P)

LED / 8W  
 (530lm, 930lm;  
 3000K) incl. • IP54  
 anthracite/white



5 996595 771034

77104 (M) (P)

LED / 8W  
 (530lm, 930lm;  
 3000K) incl. • IP54  
 anthracite/white



5 996595 771041

# CERNON



**77054**

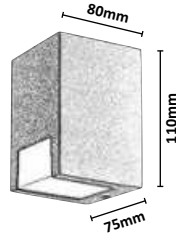

**77055**

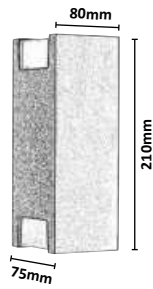

**77056**

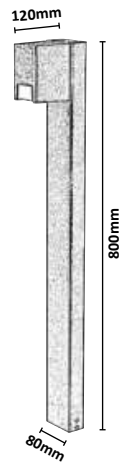

**77054** (M) (P)

☒ GU10 / 1x max. 7W  
IP44 • 20048  
black/white



**77055** (M) (P)

☒ GU10 / 2x max. 7W  
IP44 • 20049  
black/white



**77056** (M) (P)

☒ GU10 / 1x max. 7W  
IP44 • 20048  
black/white





# ODIEL



**77057**

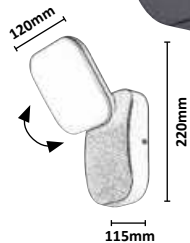

**77059**

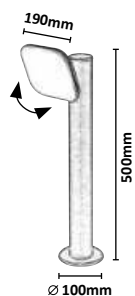

**77058**

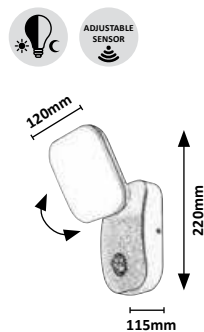

**77060**

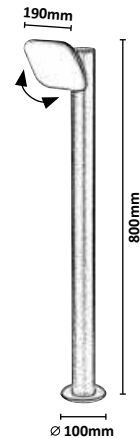

**77057** (M) (P)

LED / 12W  
 (800lm, 1400lm;  
 3000K) incl. • IP44  
 black/white



**77058** (M) (P)

LED / 12W  
 (850lm, 1400lm; 3000K) incl.  
 IP44 • 8±2m, 110°  
 black/white



**77059** (M) (P)

LED / 12W  
 (750lm, 1400lm;  
 3000K) incl. • IP44  
 black/white



**77060** (M) (P)

LED / 12W  
 (720lm, 1400lm;  
 3000K) incl. • IP44  
 black/white



# WENGEN



**77148**

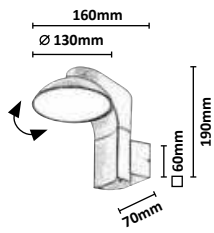

**77149**

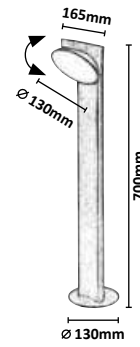

**77148** (M) (P)

LED / 12W  
 (☼790lm, ☼1100lm;  
 3000K) incl. • IP54  
 black/white



5 996595 771485

**77149** (M) (P)

LED / 12W  
 (☼790lm, ☼1100lm;  
 3000K) incl. • IP54  
 black/white



5 996595 771492

# PALANGA

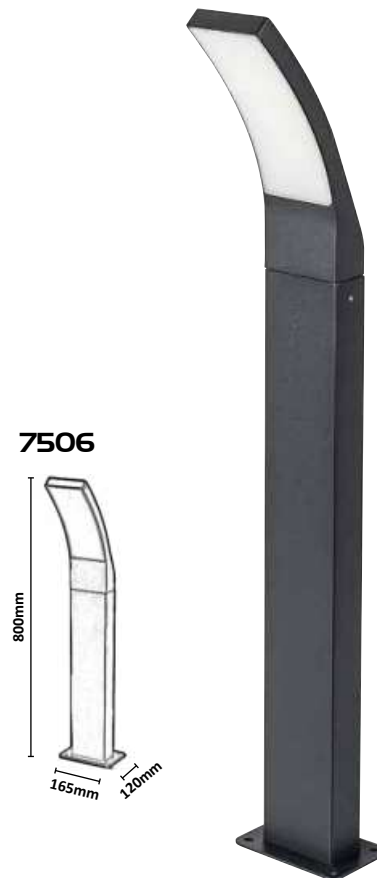

## 7504 (M P)

LED / 12W  
 (800lm, 1200lm; 3000K) incl.  
 IP44  
 anthracite/white



## 7505 (M P)

LED / 12W  
 (800lm, 1200lm; 3000K) incl.  
 IP44 • 7m, 106°  
 anthracite/white



## 7506 (M P)

LED / 12W  
 (800lm, 1200lm; 3000K) incl.  
 IP44  
 anthracite/white



# TOLNA



77171



77172



77173

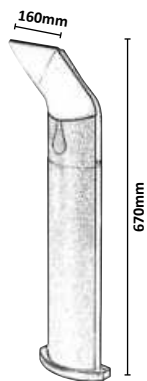

**77171** (M) (P)

LED / 10W  
 (750lm, 1200lm;  
 3000K) incl. • IP54  
 black/white



5 996595 771713

**77172** (M) (P)

LED / 10W  
 (770lm, 1200lm;  
 3000K) incl. • IP54  
 0-10m, 120° • black/white



5 996595 771720

**77173** (M) (P)

LED / 10W  
 (740lm, 1200lm;  
 3000K) incl. • IP54  
 black/white



5 996595 771737

77126, 77127, 77128



# DARVAS



77126

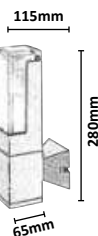

77127

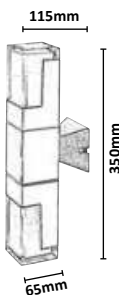

77128

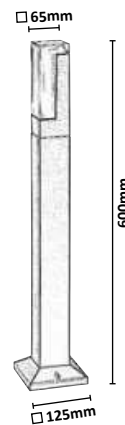

77126 (M) (P)

LED / 7W  
 (450lm, 970lm;  
 2700K, 4000K, 6000K) incl. • IP54  
 black/white/transparent



5 996595 771263

77127 (M) (P)

LED / 12W  
 (830lm, 1600lm;  
 2700K, 4000K, 6000K) incl. • IP54  
 black/white/transparent



5 996595 771270

77128 (M) (P)

LED / 7W  
 (450lm, 970lm;  
 2700K, 4000K, 6000K) incl. • IP54  
 black/white/transparent



5 996595 771287

# LEITHA



**771B0**

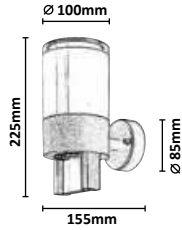

**771B1**

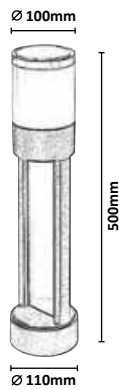

**771B2**

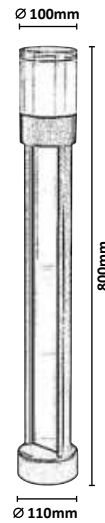

**771B0** (M) (P)

LED / 12W  
(740lm, 1300lm;  
3000K) incl. • IP44  
black/white



5 996595 771300

**771B1** (M) (P)

LED / 12W  
(720lm, 1300lm;  
3000K) incl. • IP44  
black/white



5 996595 771317

**771B2** (M) (P)

LED / 12W  
(700lm, 1300lm;  
3000K) incl. • IP44  
black/white



5 996595 771324

# ENOL



**77110** (M G)

☒ GU10 / 1x max. 35W  
IP44  
black/transparent



**77111** (M G)

☒ GU10 / 2x max. 35W  
IP44  
black/transparent



**77112** (M G)

☒ GU10 / 1x max. 35W  
IP44  
black/transparent



**77113** (M G)

☒ GU10 / 2x max. 35W  
IP44  
black/transparent



# ELVA



MOVEABLE HEADS



7930

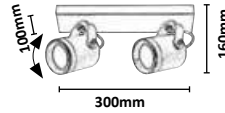

7929

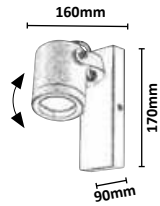

77193



# BELFAST



INDIRECT

MOVEABLE HEADS



7904

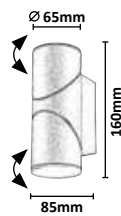

# GORDES



MOVEABLE HEADS



77193

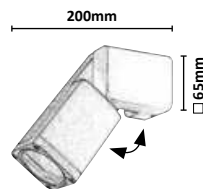

7904



7929 **M G**

☒ GU10 / 1x max. 35W  
IP44  
anthracite/transparent



5 998250 379296

7930 **M G**

☒ GU10 / 2x max. 35W  
IP44  
anthracite/transparent



5 998250 379302

7904 **M P**

☒ LED / 12,9W  
(620lm, 3000K) incl.  
IP65  
anthracite/white



5 998250 379043

77193 **M G**

☒ GU10 / 1x max. 15W  
IP65  
matte black/transparent



5 996595 771935



# TORNIO

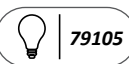

**77071**

∅ 60mm



545mm



500mm



**77072**

∅ 60mm

215mm



85mm

∅ 70mm

**77071** (M) (A)

☒ GU10 / 1x max. 10W  
IP54  
anthracite/transparent



5 996595 770716

**77072** (M) (A)

☒ GU10 / 2x max. 10W  
IP54  
anthracite/transparent



5 996595 770723

# ANKARA



**7379**

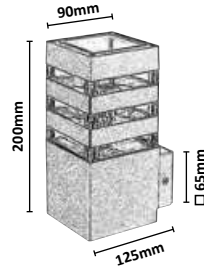

**77025**

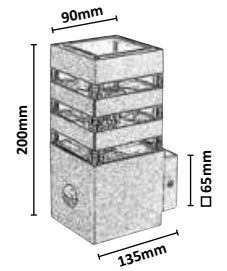

**7380**

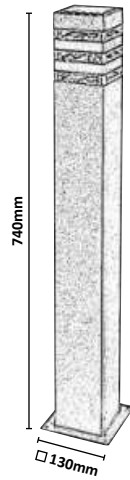

**77026**

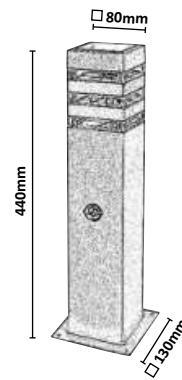

**77122**

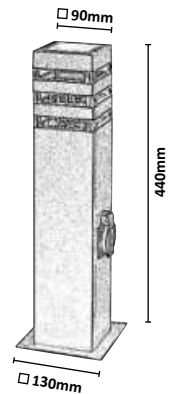

**7380** (M) (P)

☒ E27 / 1x max. 12W  
IP44  
anthracite/transparent



5 998250 373805

**7379** (M) (P)

☒ E27 / 1x max. 12W  
IP44  
anthracite/transparent



5 998250 373799

**77026** (M) (P)

☒ E27 / 1x max. 12W  
IP44 • ☒ 6-8m, 105°  
anthracite/transparent



5 996595 770266

**77025** (M) (P)

☒ E27 / 1x max. 12W  
IP44 • ☒ 6-8m, 105°  
anthracite/transparent



5 996595 770259

**77122** (M) (P)

☒ E27 / 1x max. 12W  
IP44  
black/transparent



5 996595 771225

# LOANDA



**77080**

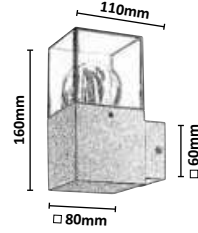

**77081**

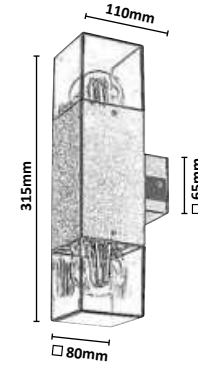

**77082**

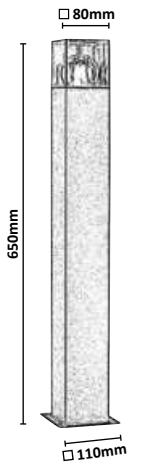

**77080** (M) (P)

☒ E27 / 1x max. 12W  
IP44 • 20051  
black/tinted colour



5 996595 770808

**77081** (M) (P)

☒ E27 / 2x max. 12W  
IP44 • 20051  
black/tinted colour



5 996595 770815

**77082** (M) (P)

☒ E27 / 1x max. 12W  
IP44 • 20051  
black/tinted colour



5 996595 770822

# TEPLICE

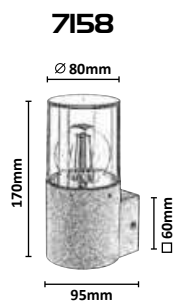
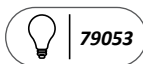

**7158**

∅ 80mm

170mm

95mm

60mm



**7159**

∅ 80mm



∅ 110mm

600mm



**7158**

**(M) (P)**

☒ E27 / 1x max. 12W  
IP44 • 19156  
matte black/tinted colour



5 998250 371580

**7159**

**(M) (P)**

☒ E27 / 1x max. 12W  
IP44 • 19156  
matte black/tinted colour



5 998250 371597

# TARPA



**77106**

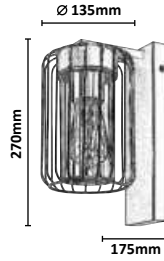

**77107**

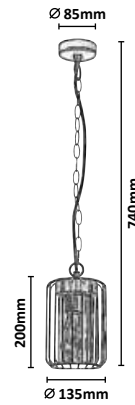

**77108**

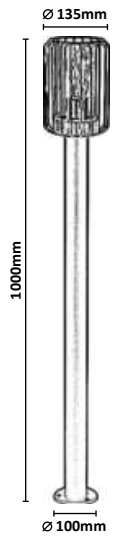

**77106** (M) (P)

⊗ E27 / 1x max. 40W  
IP44  
20029  
black/transparent



5 996595 771065

**77107** (M) (P)

⊗ E27 / 1x max. 40W  
IP44  
20029  
black/transparent



5 996595 771072

**77108** (M) (P)

⊗ E27 / 1x max. 40W  
IP44  
20029  
black/transparent



5 996595 771089

# BUDAPEST



**8888**



**8890**

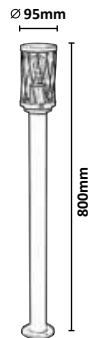

**8889**

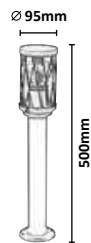

**8888** (M) (P)

☒ E27 / 1x max. 40W  
IP44  
brown/transparent



5 998250 388885

**8889** (M) (P)

☒ E27 / 1x max. 40W  
IP44  
brown/transparent



5 998250 388892

**8890** (M) (P)

☒ E27 / 1x max. 40W  
IP44  
brown/transparent



5 998250 388908



# ALMADA

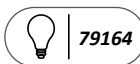

**7884**

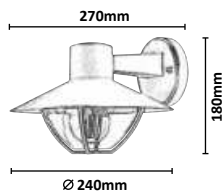

**7885**

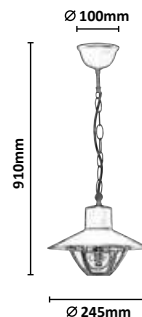

**7884** (M) (P)

☒ E27 / 1x max. 10W  
IP44 • 19855  
brown/transparent



**7885** (M) (P)

☒ E27 / 1x max. 10W  
IP44 • 19855  
brown/transparent



# PARAVENTO



**7146**

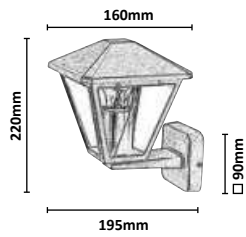

**7147**

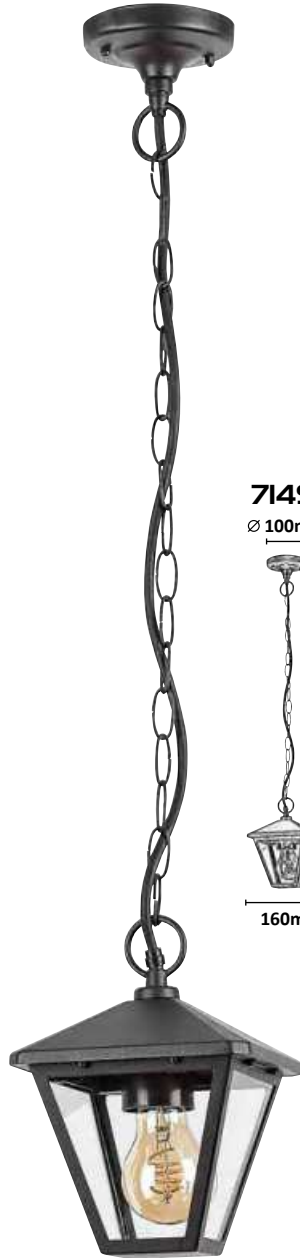
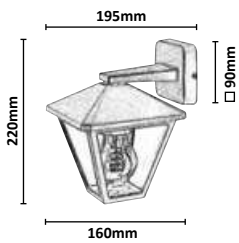

**7149**

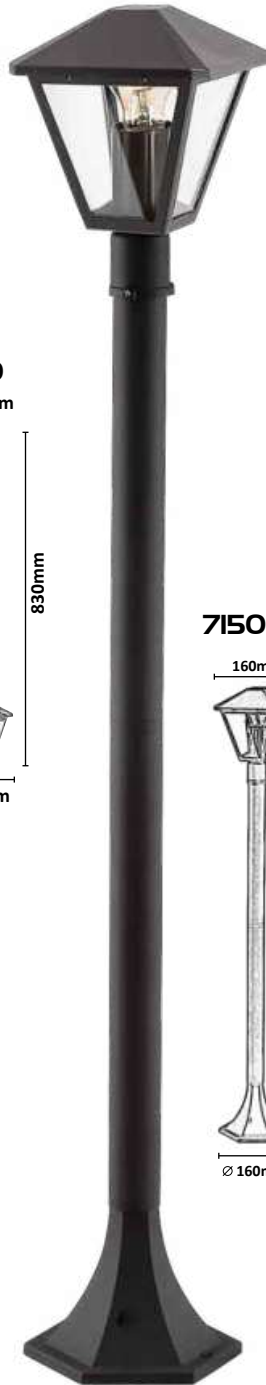
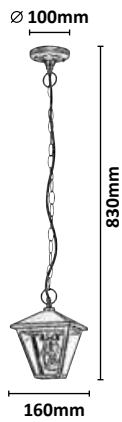

**7150**

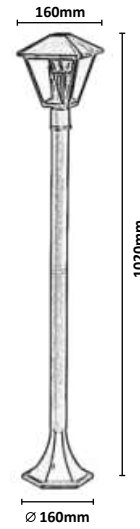

**7146** **MG**

☒ E27 / 1x max. 40W  
IP44 • 19275  
black/transparent



5 998250 371467

**7147** **MG**

☒ E27 / 1x max. 40W  
IP44 • 19275  
black/transparent



5 998250 371474

**7149** **MG**

☒ E27 / 1x max. 40W  
IP44 • 19275  
black/transparent



5 998250 371498

**7150** **MG**

☒ E27 / 1x max. 40W  
IP44 • 19275  
black/transparent



5 998250 371504



# TAVERNA

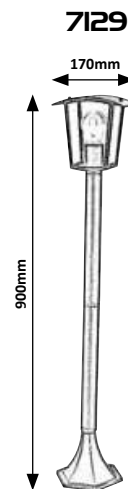
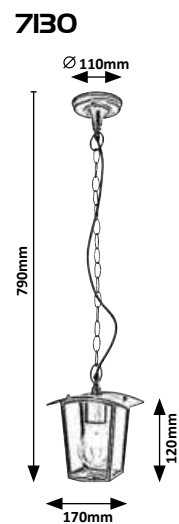
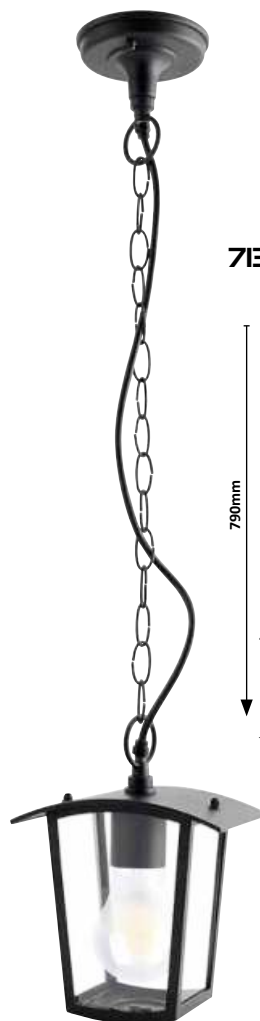
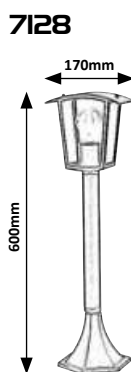
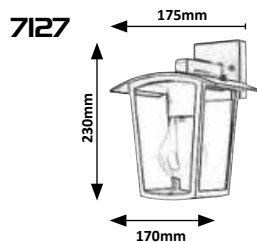

**7127** (M) (P)

☒ E27 / 1x max. 15W  
IP44 • 19983  
black/transparent



**7128** (M) (P)

☒ E27 / 1x max. 15W  
IP44 • 19983  
black/transparent



**7129** (M) (P)

☒ E27 / 1x max. 15W  
IP44 • 19983  
black/transparent



**7130** (M) (P)

☒ E27 / 1x max. 15W  
IP44 • 19983  
black/transparent



# DUBROVNIK

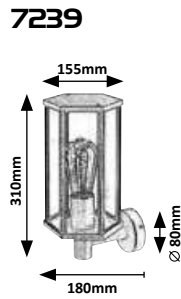
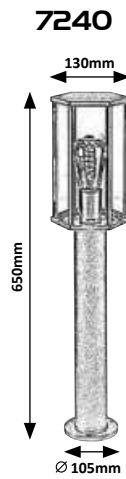
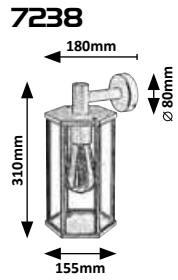

**7238** (M) (G)

☒ E27 / 1x max. 40W  
IP44 • 19166  
matte black/transparent



5 998250 372389

**7239** (M) (G)

☒ E27 / 1x max. 40W  
IP44 • 19166  
matte black/transparent



5 998250 372396

**7240** (M) (G)

☒ E27 / 1x max. 40W  
IP44 • 19166  
matte black/transparent



5 998250 372402



# BLACK TORCH

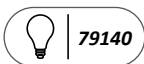

**8145**



**8146**

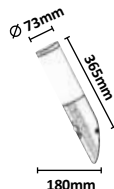

**8147**

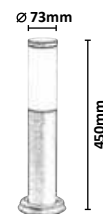

**8148**

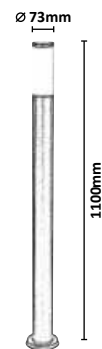

**8145** (M) (P)

☒ E27 / 1x max. 25W  
IP44 • 19607  
matte black/white



5 998250 381459

**8146** (M) (P)

☒ E27 / 1x max. 25W  
IP44 • 19607  
☒ 0-5m, 100°  
matte black/white



5 998250 381466

**8147** (M) (P)

☒ E27 / 1x max. 25W  
IP44 • 19607  
matte black/white



5 998250 381473

**8148** (M) (P)

☒ E27 / 1x max. 25W  
IP44 • 19607  
matte black/white



5 998250 381480

# BONN



**8337**

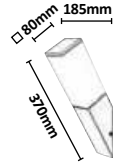

**8338**

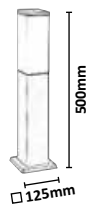

**8339**



**8337** (M) (P)

☒ E27 / 1x max. 60W  
IP44 • 19130  
matte black/white



**8338** (M) (P)

☒ E27 / 1x max. 60W  
IP44 • 19130  
matte black/white



**8339** (M) (P)

☒ E27 / 1x max. 60W  
IP44 • 19130  
matte black/white





# INOX TORCH



**8261**

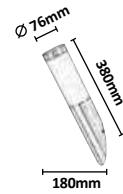

**8263**

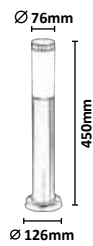

**8264**

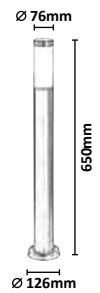

**8261** (M) (P)

☒ E27 / 1x max. 25W  
IP44 • 9437  
satin chrome/white



**8263** (M) (P)

☒ E27 / 1x max. 25W  
IP44 • 9437  
satin chrome/white



**8264** (M) (P)

☒ E27 / 1x max. 25W  
IP44 • 9437  
satin chrome/white



# INOX TORCH



**8266**

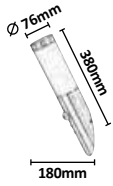

**8267**

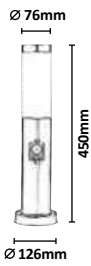

**8268**

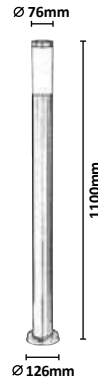

**8265**

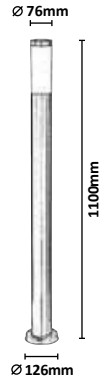

**8265** (M) (P)

☒ E27 / 1x max. 25W  
IP44 • 9437  
satin chrome/white



5 998250 382654

**8266** (M) (P)

☒ E27 / 1x max. 25W  
IP44 • 9437  
☒ 0-5m, 100°  
satin chrome/white



5 998250 382661

**8267** (M) (P)

☒ E27 / 1x max. 25W  
IP44 • 9437  
☒ 0-5m, 100°  
satin chrome/white



5 998250 382678

**8268** (M) (P)

☒ E27 / 1x max. 25W  
IP44 • 9437  
☒ 0-5m, 100°  
satin chrome /white



5 998250 382685

# LISBON



**7826**

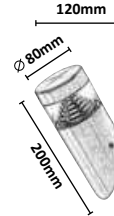

**7827**

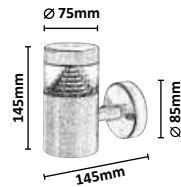

**7828**

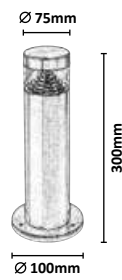

**7829**

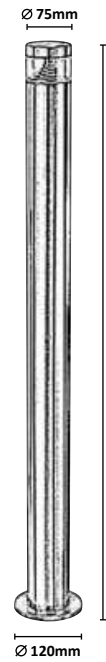

**7826** (M) (P)

LED / 7W  
 (560lm, 700lm;  
 4000K) incl. • IP54  
 stainless steel/transparent



5 998250 378268

**7827** (M) (P)

LED / 7W  
 (560lm, 700lm;  
 4000K) incl. • IP54  
 stainless steel/transparent



5 998250 378275

**7828** (M) (P)

LED / 7W  
 (560lm, 700lm;  
 4000K) incl. • IP54  
 stainless steel/transparent



5 998250 378282

**7829** (M) (P)

LED / 7W  
 (560lm, 700lm;  
 4000K) incl. • IP54  
 stainless steel/transparent



5 998250 378299





**02**

**WALL AND CEILING LAMPS**

**FALI- ÉS MENNYEZETLÁMPÁK**

**WAND- UND DECKENLAMPEN**



# MODANE



75069

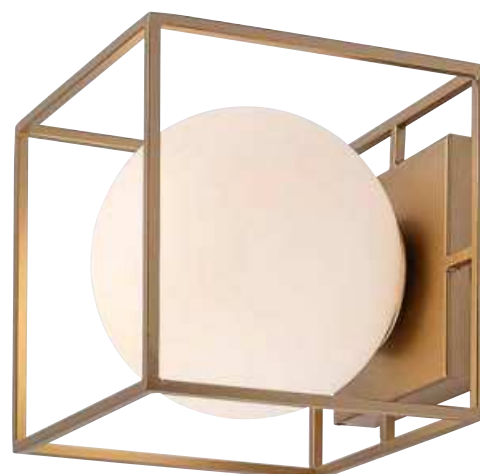
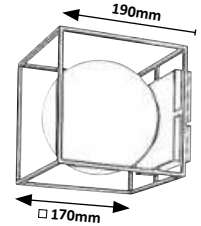

75070

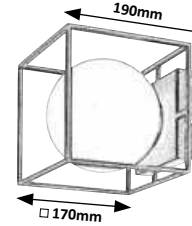

**75069** **MG**

☒ E14 / 1x max. 15W  
IP44 • 20112  
black/white



5 996595 750695

**75070** **MG**

☒ E14 / 1x max. 15W  
IP44 • 20112  
gold/white



5 996595 750701



# KELEBIA

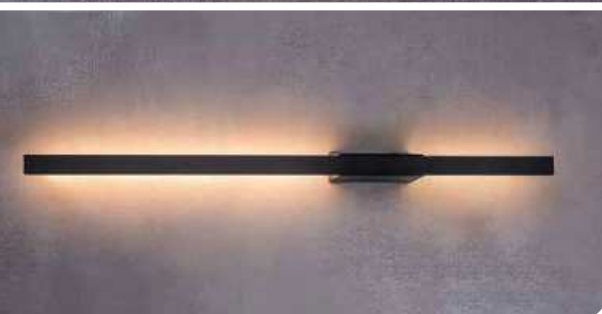

77125

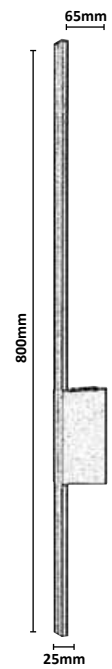

77125 (M) (P)

LED / 12W  
(1000lm, 1200lm;  
3000K) incl. • IP44  
black/white



# ZILINA

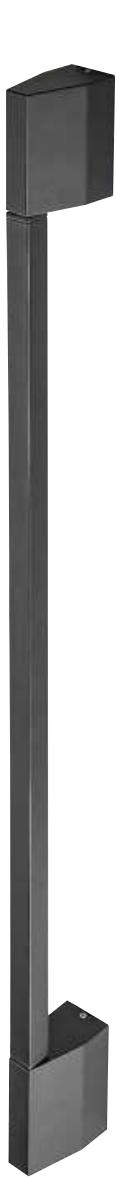

**77052**

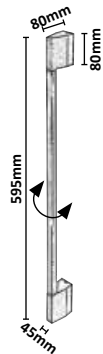

**77053**

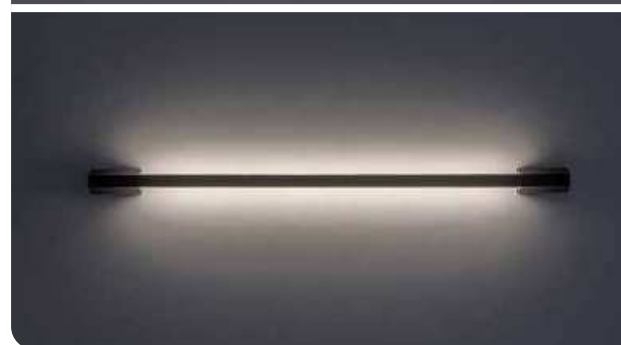
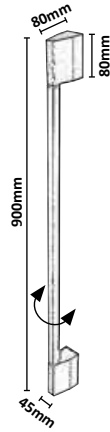

**77052** (M) (P)

LED / 8W  
 (320lm, 900lm;  
 3000K) incl. • IP54  
 matte black/white



5 996595 770525

**77053** (M) (P)

LED / 8W  
 (350lm, 1110lm;  
 3000K) incl. • IP54  
 matte black/white



5 996595 770532

# KIONI



77063

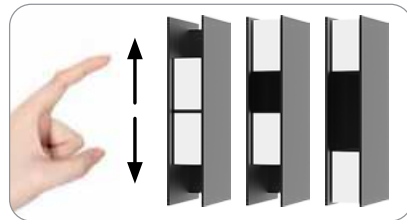
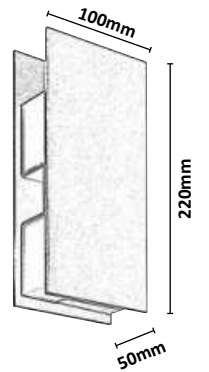

77063 (M) (P)

LED / 13W  
(680lm, 1580lm;  
3000K) incl. • IP65  
anthracite/white



5 996595 770631

# PEMBA



77077

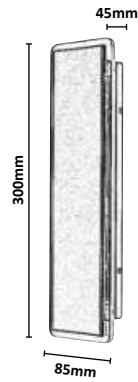

77077 **M G**

LED / 18W  
(1300lm, 2060lm;  
3000K) incl. • IP54  
black/transparent



5 996595 770778

77049



# TILBURG



77049

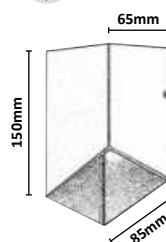

77050



77050

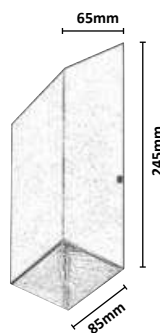

**77049** **M G**

LED / 5W  
(162lm, 570lm;  
3000K) incl. • IP54  
anthracite/transparent



5 996595 770495

**77050** **M G**

LED / 10W  
(356lm, 1137lm;  
3000K) incl. • IP54  
anthracite/transparent



5 996595 770501

# TEMSE



**77065**

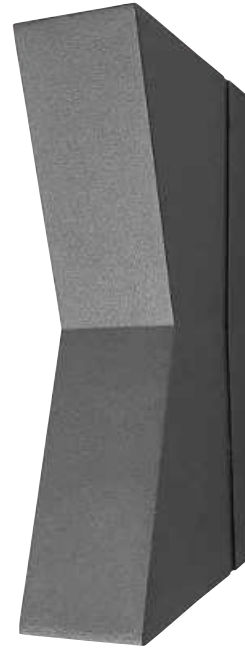
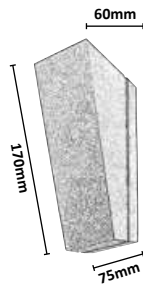

**77066**

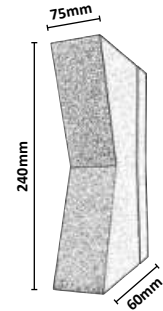

# NAVIA



**8130**

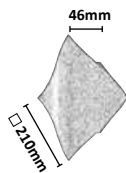

# FOLLINA



**8154**

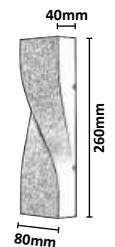

**77065** (M) (P)

LED / 3W  
(140lm, 280lm;  
4000K) incl. • IP65  
anthracite/transparent



5 996595 770655

**77066** (M) (P)

LED / 6W  
(290lm, 560lm;  
4000K) incl. • IP65  
anthracite/transparent



5 996595 770662

**8130** (M)

LED / 11W  
(641lm, 1270lm;  
4000K) incl. • IP65  
black



5 998250 381305

**8154** (M)

LED / 11W  
(530lm, 1243lm;  
4000K) incl. • IP65  
black



5 998250 381541



# RUST



**77152**

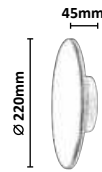

**77151**

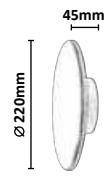

**77153**

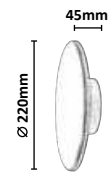

**77151**



LED / 15W  
(1500lm, 1700lm;  
2700K, 4000K, 6500K) incl. • IP65  
black



**77152**



LED / 15W  
(1500lm, 1700lm;  
2700K, 4000K, 6500K) incl. • IP65  
grey



**77153**



LED / 15W  
(1500lm, 1700lm;  
2700K, 4000K, 6500K) incl. • IP65  
brown



# GERLA



77178

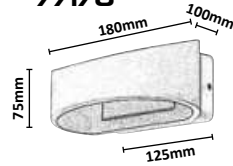

77179

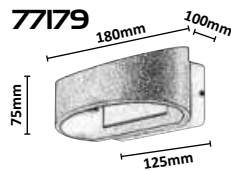

77180

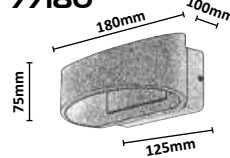

77178 (M P)

LED / 9W  
 (3370lm, 1100lm;  
 3000K) incl. • IP54  
 white



5 996595 771782

77179 (M P)

LED / 9W  
 (400lm, 1100lm;  
 3000K) incl. • IP54  
 anthracite



5 996595 771799

77180 (M P)

LED / 9W  
 (400lm, 1100lm;  
 3000K) incl. • IP54  
 brown



5 996595 771805

# BRADU



77067

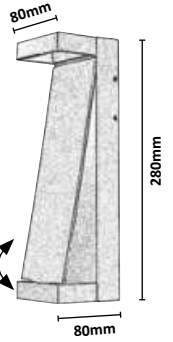

77068

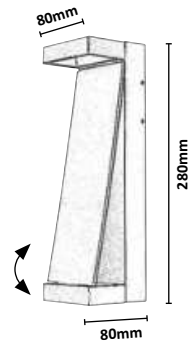

77067 **M G**

LED / 12W  
(845lm, 1400lm;  
3000K) incl. • IP65  
anthracite/transparent



5 996595 770679

77068 **M G**

LED / 12W  
(890lm, 1400lm;  
3000K) incl. • IP65  
brown/transparent



5 996595 770686

# HALLSTATT



**77168**

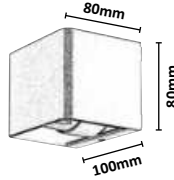

**77169**

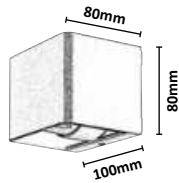

**77170**

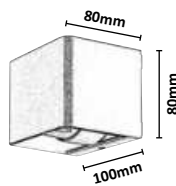

77168, 77169, 77170

INDIRECT



**77168** (M) (G)

LED / 10W  
 (320lm, 1100lm;  
 3000K) incl. • IP54  
 antrachite/transparent



5 996595 771683

**77169** (M) (G)

LED / 10W  
 (320lm, 1100lm;  
 3000K) incl. • IP54  
 brown/transparent



5 996595 771690

**77170** (M) (G)

LED / 10W  
 (360lm, 1100lm;  
 3000K) incl. • IP54  
 grey/transparent



5 996595 771706

7396, 7397

INDIRECT



INDIRECT



## SOLIN



7396

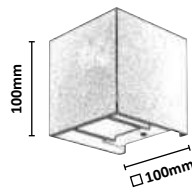

7397

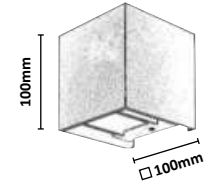

## PORTEL



INDIRECT



77191

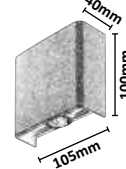

77192

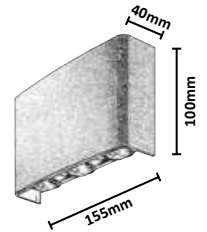

7396 (M) (P)

☒ G9 / 1x max. 5W  
IP54  
matte black



5 998250 373966

7397 (M) (P)

☒ G9 / 1x max. 5W  
IP54  
matte white



5 998250 373973

77191 (P)

☒ LED / 2W  
(☒160lm, ☒200lm;  
2000K, 2700K, 4000K) incl.  
IP65 • black/transparent



5 996595 771911

77192 (P)

☒ LED / 5W  
(☒450lm, ☒550lm;  
2000K, 2700K, 4000K) incl.  
IP65 • black/transparent



5 996595 771928

# LIPPA

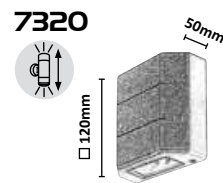
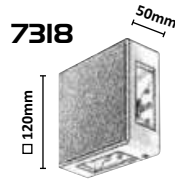
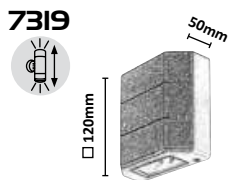

7317, 7318

INDIRECT



7319, 7320

INDIRECT



**7317** (P)

LED / 6W  
 (190lm, 660lm;  
 3000K) incl. • IP54  
 black



5 998250 373171

**7318** (P)

LED / 6W  
 (360lm, 660lm;  
 3000K) incl. • IP54  
 white



5 998250 373188

**7319** (P)

LED / 6W  
 (70lm, 660lm;  
 3000K) incl. • IP54  
 black



5 998250 373195

**7320** (P)

LED / 6W  
 (150lm, 660lm;  
 3000K) incl. • IP54  
 white



5 998250 373201

8873

INDIRECT



# MARIBOR

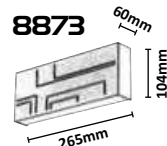
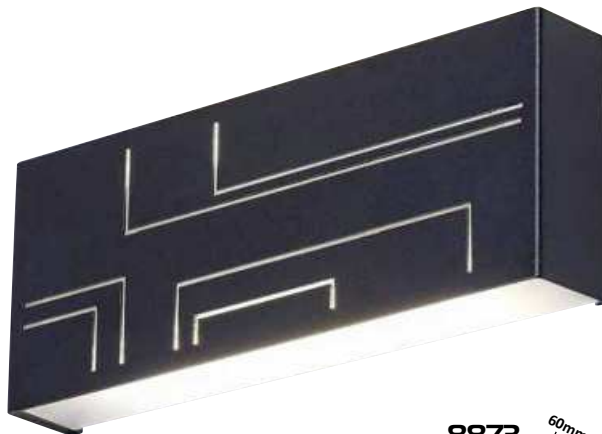

8874

INDIRECT

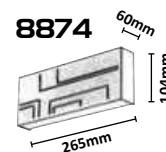

**8873** (M) (P)

LED / 12W  
(780lm, 1300lm;  
4000K) incl. • IP65  
black/white



**8874** (M) (P)

LED / 12W  
(780lm, 1300lm;  
4000K) incl. • IP65  
white



# MATARO

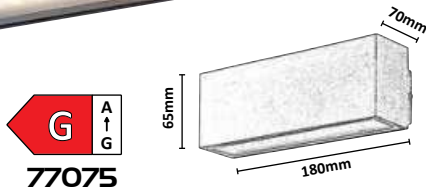
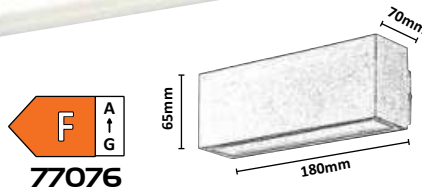
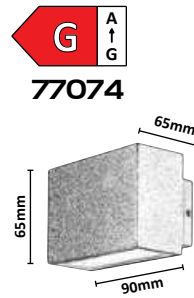
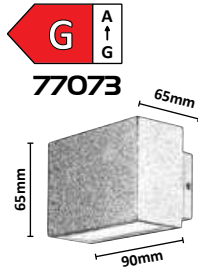

## 77073 (M) (G)

LED / 7W  
 (430lm, 800lm;  
 4000K) incl. • IP54  
 black/white



5 996595 770730

## 77074 (M) (G)

LED / 7W  
 (580lm, 800lm;  
 4000K) incl. • IP54  
 white



5 996595 770747

## 77075 (M) (G)

LED / 10W  
 (720lm, 1200lm;  
 4000K) incl. • IP54  
 black/white



5 996595 770754

## 77076 (M) (G)

LED / 10W  
 (970lm, 1200lm;  
 4000K) incl. • IP54  
 white



5 996595 770761



# NESNA



7951

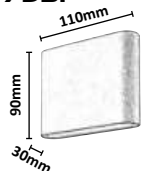

7952

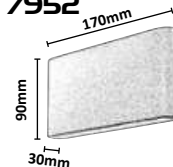

7951 (M) (G)

LED / 6W  
(386lm, 900lm; 3000K) incl.  
IP54 • 19626  
anthracite/opal glass



5 998250 379517

7952 (M) (G)

LED / 12W  
(528lm, 700lm; 3000K) incl.  
IP54 • 19630  
anthracite/opal glass



5 998250 379524

# KOBARID

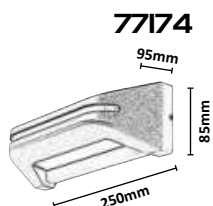

77174



77109



# MATARO

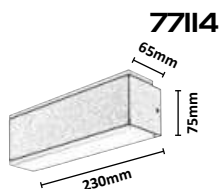
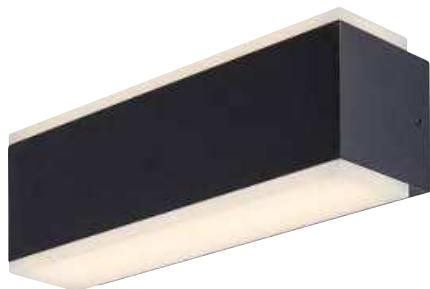

# IBAR



77114



77174 (M) (P)

LED / 20W  
 (800lm, 2300lm;  
 4000K) incl. • IP54  
 black/white



77114 (M) (P)

LED / 12W  
 (950lm, 1200lm;  
 3000K) incl. • IP54  
 black/white



77109 (P)

LED / 3W  
 (250lm, 300lm;  
 3000K) incl. • IP54  
 black/transparent



# OPOLE



**7797**

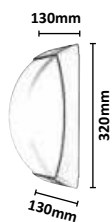

# LUBLIN



**77100**

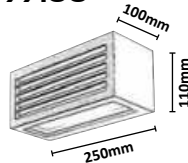

**77099**

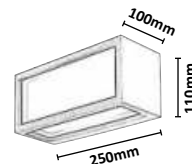

**7797**



☒ E27 / 1x max. 12W  
IP65  
matte black/white



5 998250 377971

**77099**



☑ LED / 10W  
(☑480lm, ☑1000lm; 4000K) incl.  
IP54 • ⚡ 20053  
black/white



5 996595 770990

**77100**



☑ LED / 10W  
(☑480lm, ☑1000lm; 4000K) incl.  
IP54 • ⚡ 20053  
black/white



5 996595 771003

# BIRMINGHAM

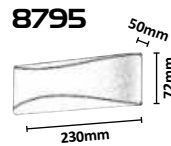

# RENNES

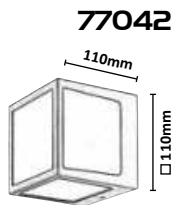

# RODEZ

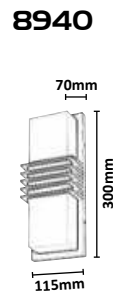

**8795** (M) (P)

LED / 7W  
(796lm, 4000K) incl.  
IP65  
anthracite/white



**77042** (P)

LED / 10W  
(580lm, 1000lm;  
4000K) incl. • IP54  
anthracite/white



**8940** (M) (P)

LED / 12W  
(800lm, 1458lm;  
4000K) incl. • IP44  
anthracite/white





## GIMONE



## ANDELLE



### 77097 (P)

LED / 10W  
 (570lm, 1000lm;  
 4000K) incl. • IP44  
 black/white



5 996595 770976

### 77098 (P)

LED / 10W  
 (660lm, 1000lm;  
 4000K) incl. • IP44  
 white



5 996595 770983

### 77095 (P)

LED / 10W  
 (500lm, 1000lm;  
 3000K) incl. • IP54  
 black/white



5 996595 770952

### 77096 (P)

LED / 10W  
 (570lm, 1000lm;  
 3000K) incl. • IP54  
 white



5 996595 770969

# BALIMO



**7477**

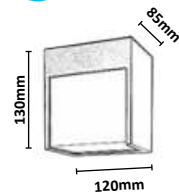

**7476**

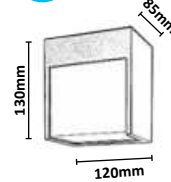

**7479**

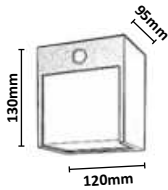

**7478**

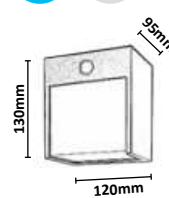

**7479**



**7476**



**7476** (M) (P)

LED / 12W  
(560lm, 1200lm;  
4000K) incl. • IP54  
matte black/white



5 998250 374765

**7477** (M) (P)

LED / 12W  
(560lm, 1200lm;  
4000K) incl. • IP54  
matte white/white



5 998250 374772

**7478** (M) (P)

LED / 12W  
(560lm, 1200lm; 4000K) incl.  
IP54 • 7m, 106°  
matte black/white



5 998250 374789

**7479** (M) (P)

LED / 12W  
(560lm, 1200lm; 4000K) incl.  
IP54 • 7m, 106°  
matte white/white



5 998250 374796

77115, 77116



# ZARAGOZA



NATURAL White

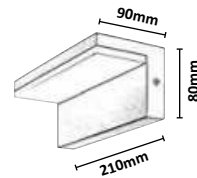

NATURAL White

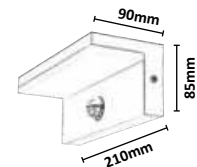
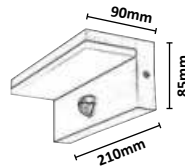
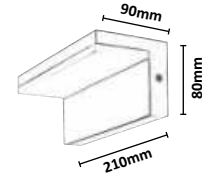

**77092** (P)

LED / 10W  
(8560lm, 10000lm;  
4000K) incl. • IP54  
black/white



5 996595 770921

**77093** (P)

LED / 10W  
(780lm, 10000lm;  
4000K) incl. • IP54  
white



5 996595 770938

**77115** (P)

LED / 9W  
(800lm, 10000lm;  
2700K, 4000K, 6500K) incl. • IP54  
6-8m, 110° • black/white



5 996595 771157

**77116** (P)

LED / 9W  
(850lm, 10000lm;  
2700K, 4000K, 6500K) incl. • IP54  
6-8m, 110° • white



5 996595 771164

# BATIDA

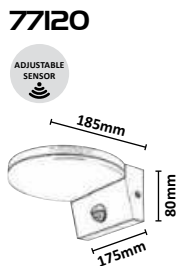
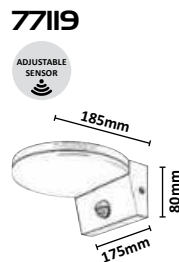
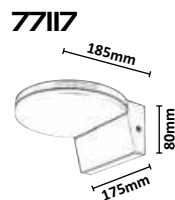

77117, 77118, 77119, 77120



**77117**

**(P)**

LED / 9W  
 (9900lm, 10000lm;  
 2700K, 4000K, 6500K) incl. • IP54  
 black/white



5 996595 771171

**77118**

**(P)**

LED / 9W  
 (9950lm, 10000lm;  
 2700K, 4000K, 6500K) incl. • IP54  
 white



5 996595 771188

**77119**

**(P)**

LED / 9W  
 (9900lm, 10000lm;  
 2700K, 4000K, 6500K) incl. • IP54  
 6-8m, 110° • black/white



5 996595 771195

**77120**

**(P)**

LED / 9W  
 (9950lm, 10000lm;  
 2700K, 4000K, 6500K) incl. • IP54  
 6-8m, 110° • white



5 996595 771201



## VARNA



**8134**

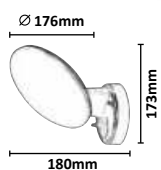

**8135**



∅ 176mm



## HALDEN



**7935**

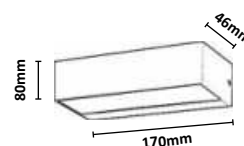

**8134** **(P)**

LED / 12W  
 (720lm, 1000lm;  
 4000K) incl. • IP54  
 black/white



**8135** **(P)**

LED / 12W  
 (720lm, 1000lm;  
 4000K) incl. • IP54  
 8m, 120° • black/white



**7935** **(P)**

LED / 9W  
 (640lm, 800lm;  
 4000K) incl. • IP65  
 black/white



# SENICA

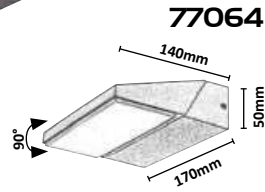

77064



# LAXA

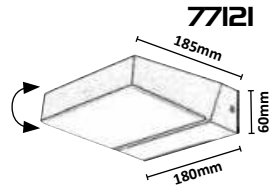

# RAPLA 2



77064 (M) (P)

LED / 13W  
 (☉)540lm, (☉)1450lm;  
 4000K) incl. • IP65  
 black/white



77121 (P)

LED / 14W  
 (☉)1400lm, (☉)1500lm;  
 2700K, 4000K, 6500K) incl. • IP54  
 black/white



77150 (P)

LED / 18W  
 (☉)1700lm, (☉)1900lm;  
 2700K, 4000K, 6500K) incl. • IP65  
 black/white



77154, 77155, 77156, 77157

# URFA



**77154**



**77155**

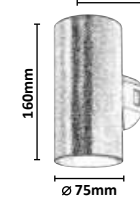

**77156**

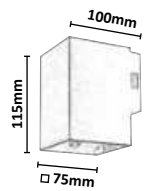

**77157**

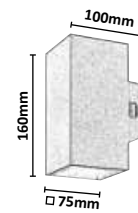

**77154**



LED / 9W  
 (9900lm, 9990lm;  
 2700K, 4000K, 6500K) incl. • IP65  
 black



5 996595 771546

**77155**



LED / 18W  
 (18000lm, 19800lm;  
 2700K, 4000K, 6500K) incl. • IP65  
 black



5 996595 771553

**77156**



LED / 9W  
 (9900lm, 9990lm;  
 2700K, 4000K, 6500K) incl. • IP65  
 black



5 996595 771560

**77157**



LED / 18W  
 (18000lm, 19800lm;  
 2700K, 4000K, 6500K) incl. • IP65  
 black



5 996595 771577

# URFA



**77162**

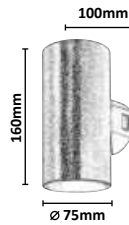

**77161**

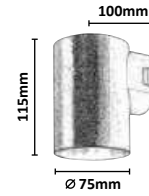

**77164**

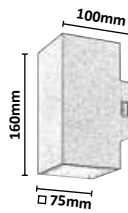

**77163**

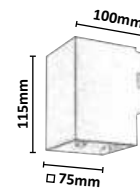

77161, 77162, 77163, 77164



**77161**



LED / 9W  
(9900lm, 9990lm;  
2700K, 4000K, 6500K) incl. • IP65  
white



5 996595 771614

**77162**



LED / 18W  
(1800lm, 1980lm;  
2700K, 4000K, 6500K) incl. • IP65  
white



5 996595 771621

**77163**



LED / 9W  
(9900lm, 9990lm;  
2700K, 4000K, 6500K) incl. • IP65  
white



5 996595 771638

**77164**



LED / 18W  
(1800lm, 1980lm;  
2700K, 4000K, 6500K) incl. • IP65  
white



5 996595 771645

77209, 77210, 77211, 77212

# URFA LINE

CCT SWITCH



77209

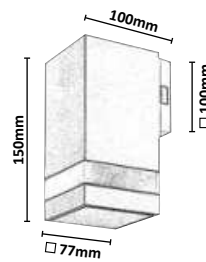

77210

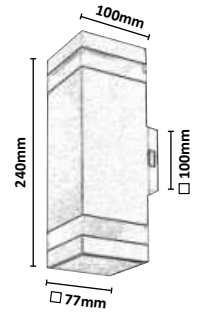

77211

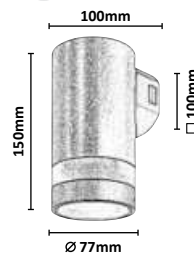

77212

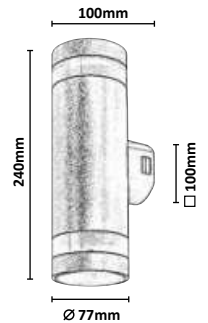

77209



LED / 9W  
 (810lm, 900lm;  
 3000K, 4000K, 6500K) incl. • IP65  
 anthracite/transparent



5 996595 772093

77210



LED / 16W  
 (1500lm, 1800lm;  
 3000K, 4000K, 6500K) incl. • IP65  
 anthracite/transparent



5 996595 772109

77211



LED / 9W  
 (800lm, 900lm;  
 3000K, 4000K, 6500K) incl. • IP65  
 brown/transparent



5 996595 772116

77212



LED / 16W  
 (1400lm, 1800lm;  
 3000K, 4000K, 6500K) incl. • IP65  
 brown/transparent



5 996595 772123

# SINTRA



7955

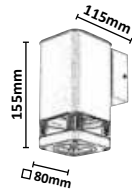

7956

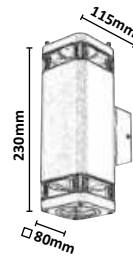

# BUFFALO



7887

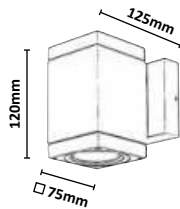

7888

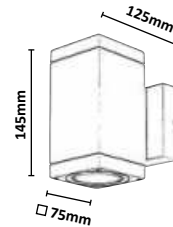

7955 (M P)

☒ GU10 / 1x max. 25W  
IP44  
matte black/transparent



5 998250 379555

7956 (M P)

☒ GU10 / 2x max. 25W  
IP44  
matte black/transparent



5 998250 379562

7887 (M G)

☒ GU10 / 1x max. 35W  
IP54  
anthracite/transparent



5 998250 378879

7888 (M G)

☒ GU10 / 2x max. 35W  
IP54  
anthracite/transparent



5 998250 378886



# MEDINA

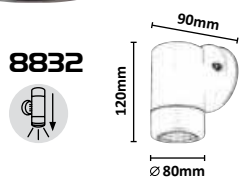

8832



8834

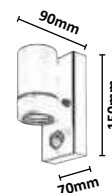

8833



8835

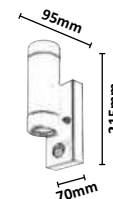

8832



☒ GU10 / 1x max. 10W  
IP44  
matte black/transparent



8833



☒ GU10 / 2x max. 10W  
IP44  
matte black/transparent



8834



☒ GU10 / 1x max. 10W  
IP44  
☒ 2-8m, 90°  
matte black/transparent



8835



☒ GU10 / 2x max. 10W  
IP44  
☒ 2-8m, 90°  
matte black/transparent



# CHILE



**8029**

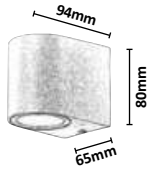

**8018**

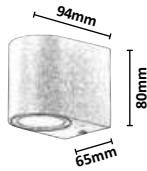

**8030**



**8019**



**8029** **MG**

☒ GU10 / 1x max. 35W  
IP44  
black



5 998250 380292

**8030** **MG**

☒ GU10 / 2x max. 35W  
IP44  
black



5 998250 380308

**8018** **MG**

☒ GU10 / 1x max. 35W  
IP44  
antique brown



5 998250 380186

**8019** **MG**

☒ GU10 / 2x max. 35W  
IP44  
antique brown



5 998250 380193



## MANDAL

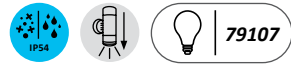

7959

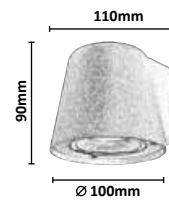

7960

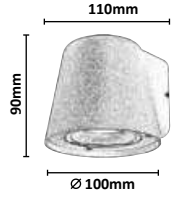

## PHOENIX



8118



8119

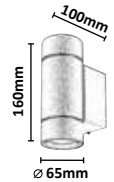

7959 **M G**

☒ GU10 / 1x max. 35W  
IP54  
matte black/transparent



5 998250 379593

7960 **M G**

☒ GU10 / 1x max. 35W  
IP54  
matte white/transparent



5 998250 379609

8118 **M G**

☒ GU10 / 1x max. 10W  
IP54 • 19625  
anthracite/transparent



5 998250 381183

8119 **M G**

☒ GU10 / 2x max. 10W  
IP54 • 19625  
anthracite/transparent



5 998250 381190

# WELLINGTON

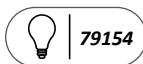

7502

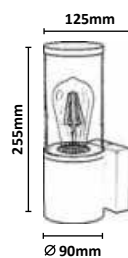

# KOLTA



7386

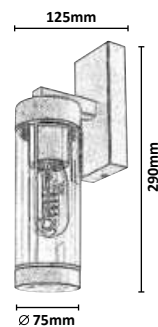

7502

(M) (P)

☒ E27 / 1x max. 60W  
IP44 • 19978  
matte black/transparent



5 998250 375021

7386

(M) (P)

☒ E27 / 1x max. 12W  
IP44 • 19150  
matte black/transparent



5 998250 373867



# NOVIGRAD



**7236**

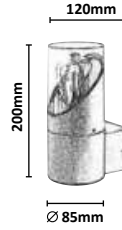

**7237**

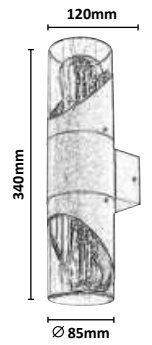

# SILISTRA



**7892**

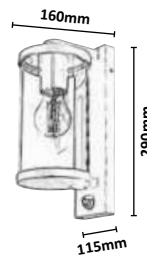

**7891**

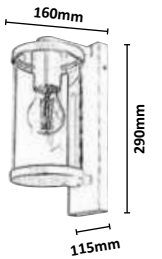

**7236** (M) (P)

☒ E27 / 1x max. 28W  
IP54 • 19168  
black/transparent



5 998250 372365

**7237** (M) (P)

☒ E27 / 2x max. 28W  
IP54 • 19168  
black/transparent



5 998250 372372

**7891** (M) (G)

☒ E27 / 1x max. 60W  
IP44 • 19852  
anthracite/transparent



5 998250 378916

**7892** (M) (G)

☒ E27 / 1x max. 60W  
IP44 • 19852  
☑ 1-12m, 110°  
anthracite/transparent



5 998250 378923

# ZERNEST



**77085**

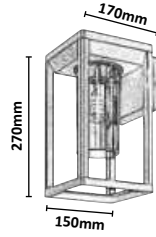

**77086**

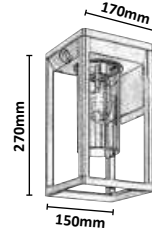

# ZATON



**7070**

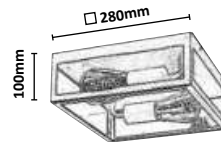

**77085** (M) (P)

☒ E27 / 1x max. 15W  
IP54 • 20056  
black/transparent



5 996595 770853

**77086** (M) (P)

☒ E27 / 1x max. 15W  
IP54 • 20056  
☺ 2-6m, 110°  
black/transparent



5 996595 770860

**7070** (M) (G)

☒ E27 / 2x max. 60W  
IP23 • 19246  
matte black/transparent



5 998250 370705

# ROMA



**8409**

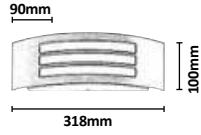

**8511**

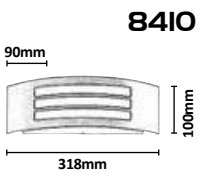
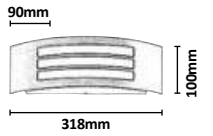

**8410**

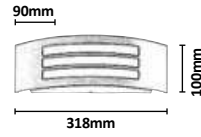

**8776**



**8409** (M) (P)

☒ E27 / 1x max. 14W  
IP44  
matte black/white



5 998250 384092

**8410** (M) (P)

☒ E27 / 1x max. 14W  
IP44  
satin chrome/white



5 998250 384108

**8511** (M) (P)

☒ E27 / 1x max. 14W  
IP44  
antique gold/white



5 998250 385112

**8776** (M) (P)

☒ E27 / 1x max. 14W  
IP44  
anthracite/white



5 998250 387765

## DURANGO



**8766**

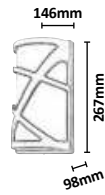

**8767**



## ORLOVA



**7244**

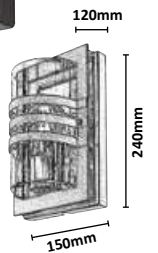

## SEVILLA



**8799**

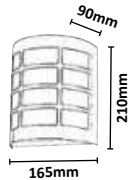

**8800**

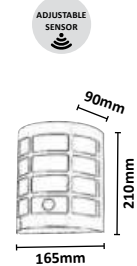

**8766** (M) (P)

☒ E27 / 1x max. 40W  
IP54  
brown/white



5 998250 387666

**8767** (M) (P)

☒ E27 / 1x max. 40W  
IP54  
anthracite/white



5 998250 387673

**8799** (M) (P)

☒ E27 / 1x max. 11W  
IP44  
satin chrome/white



5 998250 387994

**8800** (M) (P)

☒ E27 / 1x max. 11W  
IP44 • 0-5m, 100°  
satin chrome/white



5 998250 388007

**7244** (M) (P)

☒ E27 / 1x max. 40W  
IP44 • 19177  
black/transparent



5 998250 372440

# ZOMBOR

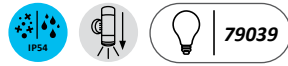

**7817**



**7818**

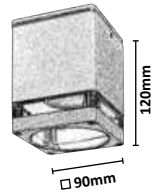

**7819**

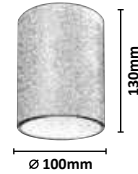

**7820**

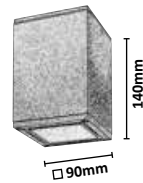

**7817** (M) (P)

☒ GU10 / 1x max. 35W  
IP54  
anthracite/transparent



**7818** (M) (P)

☒ GU10 / 1x max. 35W  
IP54  
anthracite/transparent



**7819** (M) (G)

☒ GU10 / 1x max. 35W  
IP54  
anthracite/opal glass



**7820** (M) (G)

☒ GU10 / 1x max. 35W  
IP54  
anthracite/opal glass



# AKRON



**8149**

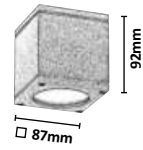

**8150**



# KOVEN

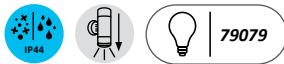

**71343**

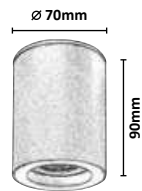

**71342**

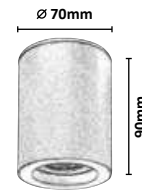

**8149** **MG**

☒ GU10 / 1x max. 35W  
IP54  
anthracite/transparent



5 998250 381497

**8150** **MG**

☒ GU10 / 1x max. 35W  
IP54  
anthracite/transparent



5 998250 381503

**71342** **MG**

☒ GU10 / 1x max. 35W  
IP44  
black



5 996595 713423

**71343** **MG**

☒ GU10 / 1x max. 35W  
IP44  
white



5 996595 713430



# DOLEN

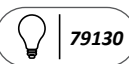

**75067**

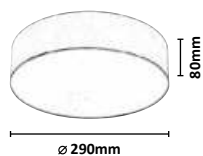

**75068**

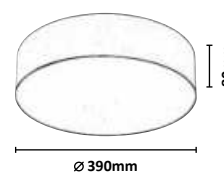

**75067** (M) (P)

☒ E27 / 2x max. 9W  
IP43  
grey-beige/white



5 996595 750671

**75068** (M) (P)

☒ E27 / 3x max. 9W  
IP43  
grey-beige/white



5 996595 750688

# DOLEN

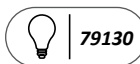

**75065**

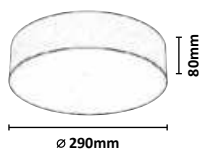

**75066**

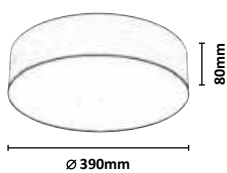

**75065** (M) (P)

☒ E27 / 2x max. 9W  
IP43  
black/white



5 996595 750657

**75066** (M) (P)

☒ E27 / 3x max. 9W  
IP43  
black/white



5 996595 750664



# MAUREC



PLASTIC



75080



75081



75082



75080



LED / 18W  
 (1540lm, 1900lm;  
 3000K, 4000K, 6000K) incl.  
 IP44 • brown/white



5 996595 750800

75081



LED / 18W  
 (1575lm, 1900lm;  
 3000K, 4000K, 6000K) incl.  
 IP44 • anthracite/white



5 996595 750817

75082



LED / 18W  
 (1550lm, 1900lm;  
 3000K, 4000K, 6000K) incl.  
 IP44 • wood imitation/white



5 996595 750824

# LAUTREC



**75083**

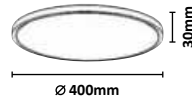

**75084**

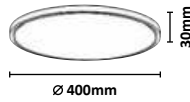

**75085**

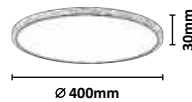

**75083**



LED / 24W  
 (2030lm, 2640lm;  
 3000K, 4000K, 6500K) incl.  
 IP44 • brown/white



5 996595 750831

**75084**



LED / 24W  
 (2030lm, 2640lm;  
 3000K, 4000K, 6500K) incl.  
 IP44 • antrachite/white



5 996595 750848

**75085**



LED / 24W  
 (2030lm, 2640lm;  
 3000K, 4000K, 6500K) incl.  
 IP44 • wood imitation/white



5 996595 750855

71431, 71441



7774, 7775



# INVERNESS

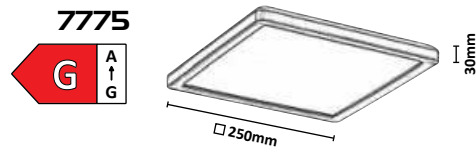
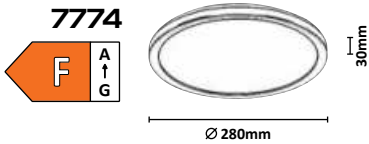

# ALENZO

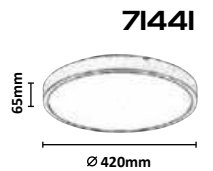
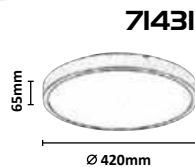

**7774** (P)  
 LED / 15W  
 (1300lm, 2000lm;  
 2700K-6500K) incl. • IP44  
 555 • black/white  
  
 5 998250 377742

**7775** (P)  
 LED / 15W  
 (1190lm, 1800lm;  
 2700K-6500K) incl. • IP44  
 555 • black/white  
  
 5 998250 377759

**7143I** (P)  
 LED / 36W  
 (2450lm, 3600lm;  
 3000K, 4000K, 6000K) incl.  
 IP44 • white  
  
 5 996595 714314

**7144I** (P)  
 LED / 36W  
 (2380lm, 3600lm;  
 3000K, 4000K, 6000K) incl.  
 IP44 • black/white  
  
 5 996595 714413

77035, 77036

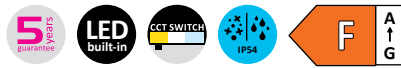

# INDRE



**77035**

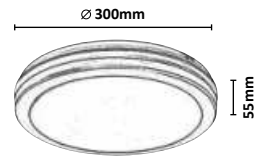

**77036**

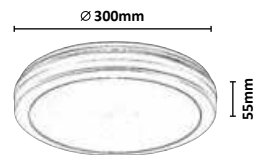

**77035** (P)

LED / 28W  
(2450lm, 3450lm;  
3000K, 4000K, 6500K) incl. • IP54  
black/white



5 996595 770358

**77036** (P)

LED / 28W  
(2600lm, 3450lm;  
3000K, 4000K, 6500K) incl. • IP54  
white



5 996595 770365

# PERNIK



**7250**

NATURAL  
White



**7265**

WARM  
White



**7250**



LED / 24W  
 (2400lm, 2565lm; 4000K) incl.  
 IP54  
 black/white



5 998250 372501

**7265**













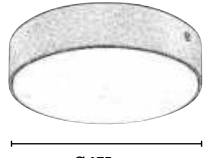

LED / 24W  
 (2400lm, 2565lm; 3000K) incl.  
 IP54  
 black/white





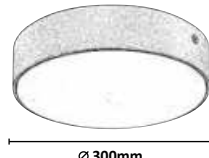







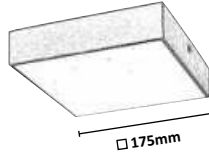

5 998250 372655



	<p><b>7893</b></p> <p>LED / 18W                  (1800lm, 1980lm);                  2800K, 4000K, 6000K) incl.                  IP44 • matte white/white</p>			 <p>5 998250 378930</p>
	<p><b>7897</b></p> <p>LED / 18W                  (1800lm, 1980lm);                  2800K, 4000K, 6000K) incl.                  IP44 • matte black/white</p>			 <p>5 998250 378978</p>

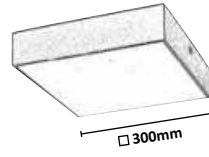



	<p><b>7894</b></p> <p>LED / 24W                  (2500lm, 2750lm);                  2800K, 4000K, 6000K) incl.                  IP44 • matte white/white</p>			 <p>5 998250 378947</p>
	<p><b>7898</b></p> <p>LED / 24W                  (2500lm, 2750lm);                  2800K, 4000K, 6000K) incl.                  IP44 • matte black/white</p>			 <p>5 998250 378985</p>





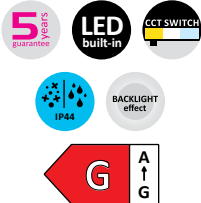
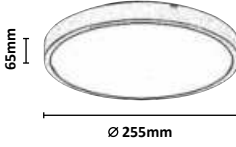

	<p><b>7895</b></p> <p>LED / 18W                  (1800lm, 1980lm);                  2800K, 4000K, 6000K) incl.                  IP44 • matte white/white</p>			 <p>5 998250 378954</p>
	<p><b>7899</b></p> <p>LED / 18W                  (1800lm, 1980lm);                  2800K, 4000K, 6000K) incl.                  IP44 • matte black/white</p>			 <p>5 998250 378992</p>



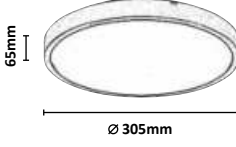

	<p><b>7896</b></p> <p>LED / 24W                  (2500lm, 2750lm);                  2800K, 4000K, 6000K) incl.                  IP44 • matte white/white</p>			 <p>5 998250 378961</p>
	<p><b>7900</b></p> <p>LED / 24W                  (2500lm, 2750lm);                  2800K, 4000K, 6000K) incl.                  IP44 • matte black/white</p>			 <p>5 998250 379005</p>





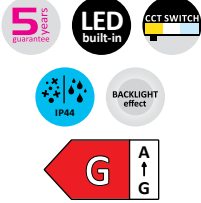







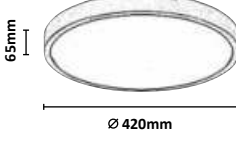



	<p><b>71425</b></p> <p>LED / 12W                  (☉790lm, ☉1200lm;                  3000K, 4000K, 6000K) incl.                  IP44 • white</p>			 <p>5 996595 714253</p>
	<p><b>71435</b></p> <p>LED / 12W                  (☉780lm, ☉1200lm;                  3000K, 4000K, 6000K) incl.                  IP44 • black/white</p>			 <p>5 996595 714352</p>



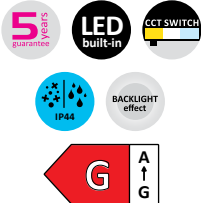





	<p><b>71426</b></p> <p>LED / 18W                  (☉1250lm, ☉1800lm;                  3000K, 4000K, 6000K) incl.                  IP44 • white</p>			 <p>5 996595 714260</p>
	<p><b>71436</b></p> <p>LED / 18W                  (☉1200lm, ☉1800lm;                  3000K, 4000K, 6000K) incl.                  IP44 • black/white</p>			 <p>5 996595 714369</p>

	<p><b>71427</b></p> <p>LED / 24W                  (☉1600lm, ☉2400lm;                  3000K, 4000K, 6000K) incl.                  IP44 • white</p>			 <p>5 996595 714277</p>
	<p><b>71437</b></p> <p>LED / 24W                  (☉1500lm, ☉2400lm;                  3000K, 4000K, 6000K) incl.                  IP44 • black/white</p>			 <p>5 996595 714376</p>







	<p><b>71429</b></p> <p>LED / 36W                  (☉2450lm, ☉3600lm;                  3000K, 4000K, 6000K) incl.                  IP44 • white</p>			 <p>5 996595 714291</p>
	<p><b>71439</b></p> <p>LED / 36W                  (☉2300lm, ☉3600lm;                  3000K, 4000K, 6000K) incl.                  IP44 • black/white</p>			 <p>5 996595 714390</p>



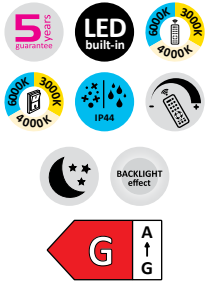
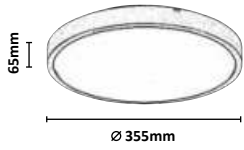



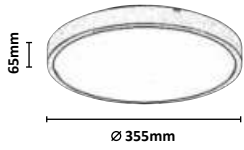





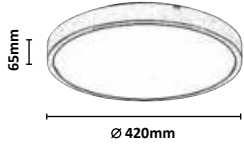

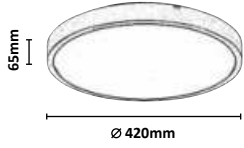

	<p><b>71422</b></p> <p>LED / 24W                  (1600lm, 2400lm;                  3000K, 4000K, 6000K) incl.                  IP44 • white</p>			 <p>5 996595 714222</p>
	<p><b>71432</b></p> <p>LED / 24W                  (1450lm, 2400lm;                  3000K, 4000K, 6000K) incl.                  IP44 • black/white</p>			 <p>5 996595 714321</p>

	<p><b>71423</b></p> <p>LED / 36W                  (2350lm, 3600lm;                  3000K, 4000K, 6000K) incl.                  IP44 • white</p>			 <p>5 996595 714239</p>
	<p><b>71433</b></p> <p>LED / 36W                  (2270lm, 3600lm;                  3000K, 4000K, 6000K) incl.                  IP44 • black/white</p>			 <p>5 996595 714338</p>

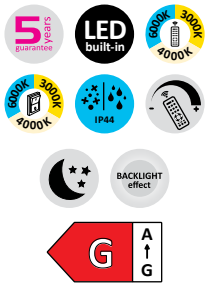





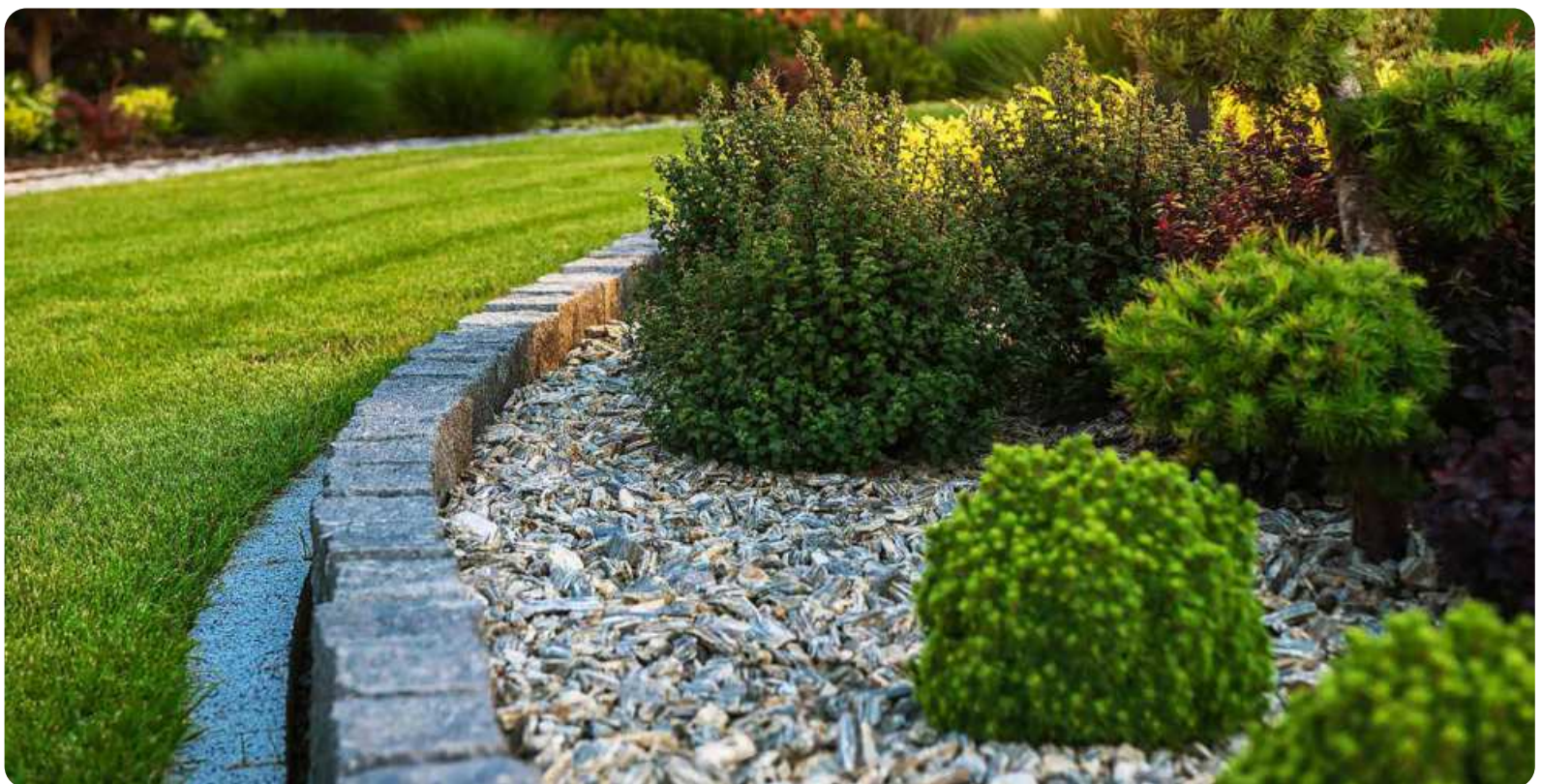

	<p><b>71428</b></p> <p>LED / 24W                  (21530lm, 2400lm);                  3000K, 4000K, 6000K) incl.                  406 • IP44 • white</p>			 <p>5 996595 714284</p>
	<p><b>71438</b></p> <p>LED / 24W                  (1500lm, 2400lm;                  3000K, 4000K, 6000K) incl.                  406 • IP44 • black/white</p>			 <p>5 996595 714383</p>





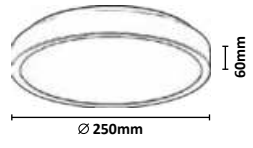

	<p><b>71430</b></p> <p>LED / 36W                  (2450lm, 3600lm);                  3000K, 4000K, 6000K) incl.                  406 • IP44 • white</p>			 <p>5 996595 714307</p>
	<p><b>71440</b></p> <p>LED / 36W                  (2390lm, 3600lm);                  3000K, 4000K, 6000K) incl.                  406 • IP44 • black/white</p>			 <p>5 996595 714406</p>





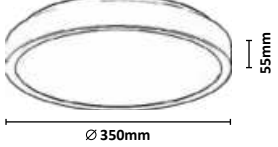

	<p><b>71424</b></p> <p>LED / 36W                  (2350lm, 3600lm);                  3000K, 4000K, 6000K) incl.                  406 • IP44 • white</p>			 <p>5 996595 714246</p>
	<p><b>71434</b></p> <p>LED / 36W                  (2300lm, 3600lm);                  3000K, 4000K, 6000K) incl.                  406 • IP44 • black/white</p>			 <p>5 996595 714345</p>



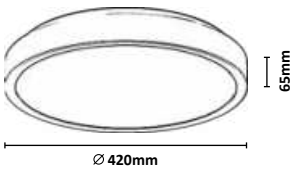

	<p><b>71252</b></p> <p>LED / 18W                  (☉1380lm, ☉1800lm;                  4000K) incl. • IP44                  black/white</p>			 <p>5 996595 712525</p>
	<p><b>71257</b></p> <p>LED / 18W                  (☉1400lm, ☉1800lm;                  4000K) incl. • IP44                  white</p>			 <p>5 996595 712570</p>







	<p><b>71253</b></p> <p>LED / 36W                  (☉2900lm, ☉3600lm;                  4000K) incl. • IP44                  black/white</p>			 <p>5 996595 712532</p>
	<p><b>71258</b></p> <p>LED / 36W                  (☉2930lm, ☉3600lm;                  4000K) incl. • IP44                  white</p>			 <p>5 996595 712587</p>





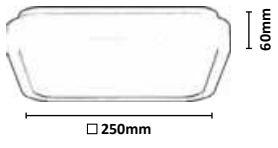

	<p><b>71254</b></p> <p>LED / 48W                  (☉3100lm, ☉4800lm;                  4000K) incl. • IP44                  black/white</p>			 <p>5 996595 712549</p>
	<p><b>71259</b></p> <p>LED / 48W                  (☉3150lm, ☉4800lm;                  4000K) incl. • IP44                  white</p>			 <p>5 996595 712594</p>

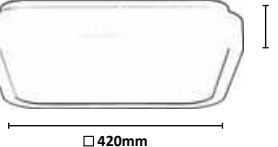

# SAMIRA

P

	<p><b>71255</b></p> <p>LED / 18W              (☉1400lm, ☉1800lm;              4000K) incl. • IP44              black/white</p>			 <p>5 996595 712556</p>
	<p><b>71260</b></p> <p>LED / 18W              (☉1430lm, ☉1800lm;              4000K) incl. • IP44              white</p>			 <p>5 996595 712600</p>

	<p><b>71256</b></p> <p>LED / 48W              (☉3100lm, ☉4800lm;              4000K) incl. • IP44              black/white</p>			 <p>5 996595 712563</p>
	<p><b>71261</b></p> <p>LED / 48W              (☉3150lm, ☉4800lm;              4000K) incl. • IP44              white</p>			 <p>5 996595 712617</p>

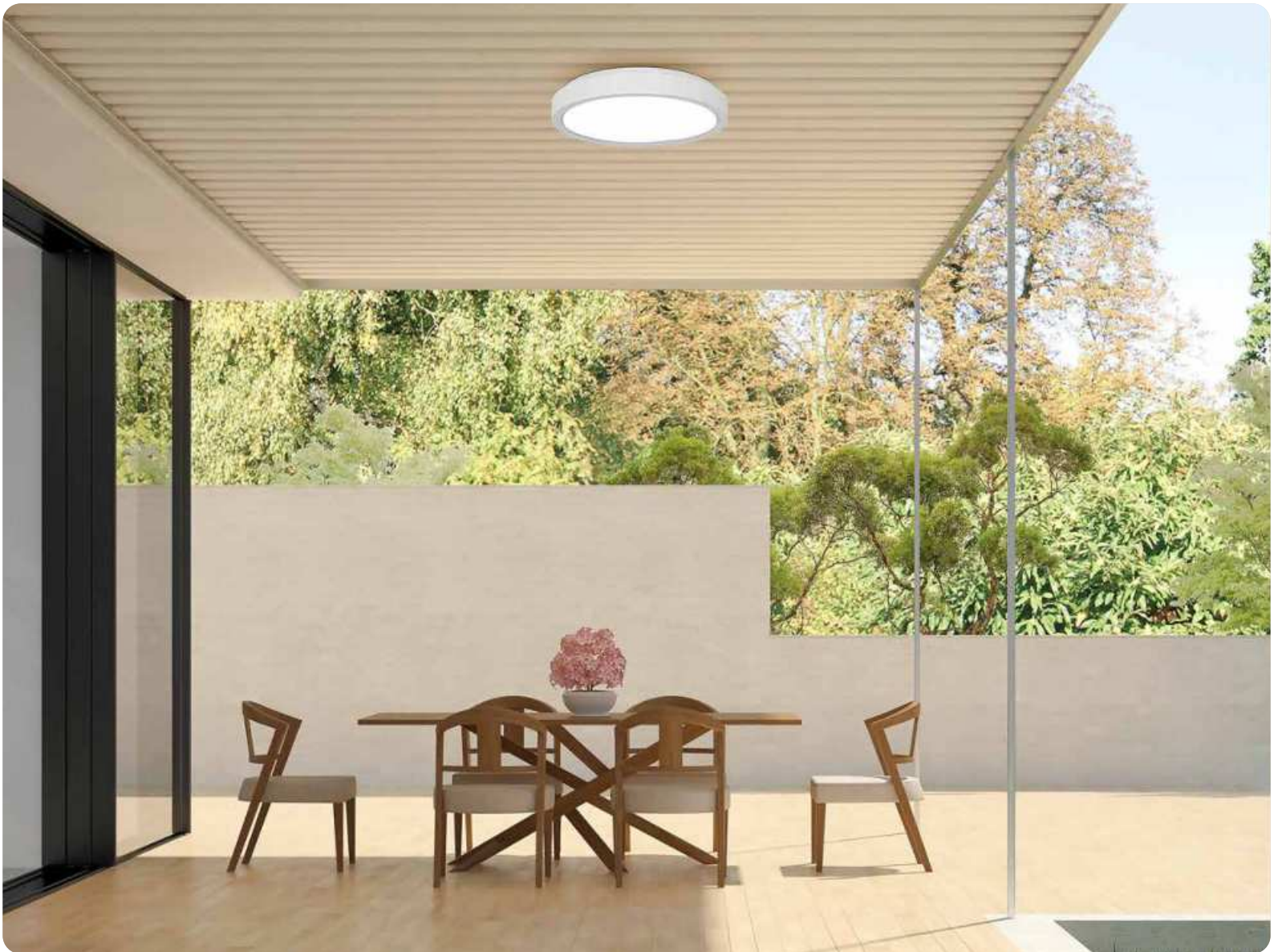

	<p><b>77133</b></p> <p>LED / 12W                      (☼) 750lm; (☼) 1200lm,                      3000K, 4000K, 6000K) incl.                      IP44 • white</p>			 <p>5 996595 771331</p>
	<p><b>77134</b></p> <p>LED / 12W                      (☼) 750lm; (☼) 1200lm,                      3000K, 4000K, 6000K) incl.                      IP44 • white</p>			 <p>5 996595 771348</p>
	<p><b>77135</b></p> <p>LED / 36W                      (☼) 2300lm; (☼) 3600lm,                      3000K, 4000K, 6000K) incl.                      IP44 • white</p>			 <p>5 996595 771355</p>
	<p><b>77136</b></p> <p>LED / 36W                      (☼) 2300lm; (☼) 3600lm,                      3000K, 4000K, 6000K) incl.                      IP44 • white</p>			 <p>5 996595 771362</p>
	<p><b>77182</b></p> <p>LED / 18W                      (☼) 1100lm; (☼) 1800lm,                      3000K, 4000K, 6000K) incl.                      IP44 • white</p>			 <p>5 996595 771829</p>
	<p><b>77181</b></p> <p>LED / 18W                      (☼) 1100lm; (☼) 1800lm,                      3000K, 4000K, 6000K) incl.                      IP44 • white</p>			 <p>5 996595 771812</p>







	<p><b>71504 - Lucas2</b></p> <p>LED / 12W                      (1050lm, 1200lm;                      4000K) incl. • IP44                      20200 • white</p>	<p>F A ↑ G</p> <p>New</p>	<p>I 55mm</p> <p>∅ 255mm</p>	<p>5 996595 715045</p>
	<p><b>71505 - Lucas2</b></p> <p>LED / 18W                      (1450lm, 1800lm;                      4000K) incl. • IP44                      20201 • white</p>	<p>G A ↑ G</p> <p>New</p>	<p>I 60mm</p> <p>∅ 320mm</p>	<p>5 996595 715052</p>
	<p><b>71506 - Lucas2</b></p> <p>LED / 24W                      (1850lm, 2400lm;                      4000K) incl. • IP44                      20202 • white</p>	<p>G A ↑ G</p> <p>New</p>	<p>I 50mm</p> <p>∅ 375mm</p>	<p>5 996595 715069</p>
	<p><b>71510 - Lucas2</b></p> <p>LED / 12W                      (1150lm, 1200lm;                      4000K) incl. • IP44                      20206 • white</p>	<p>F A ↑ G</p> <p>New</p>	<p>I 55mm</p> <p>∅ 255mm</p>	<p>5 996595 715106</p>
	<p><b>71511 - Lucas2</b></p> <p>LED / 18W                      (1460lm, 1800lm;                      4000K) incl. • IP44                      20207 • white</p>	<p>G A ↑ G</p> <p>New</p>	<p>I 60mm</p> <p>∅ 320mm</p>	<p>5 996595 715113</p>
	<p><b>71512 - Lucas2</b></p> <p>LED / 24W                      (1970lm, 2400lm;                      4000K) incl. • IP44                      20208 • white</p>	<p>G A ↑ G</p> <p>New</p>	<p>I 50mm</p> <p>∅ 375mm</p>	<p>5 996595 715120</p>
	<p><b>3437 - Lucas</b></p> <p>LED / 12W                      (900lm, 4000K) incl.                      IP44 • 19714                      white</p>	<p>G A ↑ G</p>	<p>I 90mm</p> <p>∅ 260mm</p>	<p>5 998250 334370</p>
	<p><b>3438 - Lucas</b></p> <p>LED / 18W                      (1350lm, 4000K) incl.                      IP44 • 19715                      white</p>	<p>G A ↑ G</p>	<p>I 110mm</p> <p>∅ 330mm</p>	<p>5 998250 334387</p>
	<p><b>3439 - Lucas</b></p> <p>LED / 24W                      (1800lm, 4000K) incl.                      IP44 • 19716                      white</p>	<p>G A ↑ G</p>	<p>I 110mm</p> <p>∅ 380mm</p>	<p>5 998250 334394</p>

## GAELO



75025

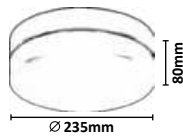

75026

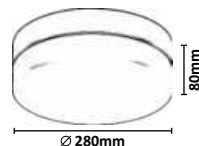

75025, 75026



## ZENON



2697



2698



## ERIC



7979

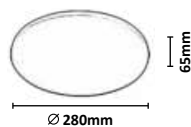

### 75025 (M P)

LED / 15W  
(1150lm, 1500lm;  
4000K) incl. • IP44 • 20098  
black/white



5 996595 750251

### 75026 (M P)

LED / 18W  
(1370lm, 1820lm;  
4000K) incl. • IP44 • 20094  
black/white



5 996595 750268

### 2697 (P)

LED / 18W  
(1450lm, 1880lm;  
3000K, 4000K, 6000K) incl.  
IP54 • white



5 998250 326979

### 2698 (P)

LED / 24W  
(2100lm, 2565lm;  
3000K, 4000K, 6000K) incl.  
IP54 • white



5 998250 326986

### 7979 (P)

LED / 24W  
(2160lm, 3252lm;  
4000K) incl. • IP64  
white



5 998250 379791



# LARCIA



**75009**

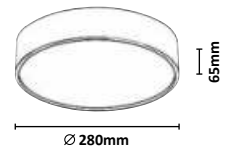

**75010**

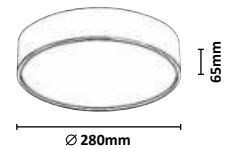

**75009** **P**

LED / 18W  
(970lm, 1800lm;  
4000K) incl. • IP44 • 19992  
black/white



**75010** **P**

LED / 18W  
(1060lm, 1800lm;  
4000K) incl. • IP44 • 19134  
silver/white



# STUTTGART



79112



**8683**

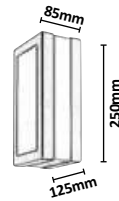

**8684**



**8685**



**8683** (M) (P)

☒ E27 / 1x max. 14W  
IP44  
anthracite/white



5 998250 386836

**8684** (M) (P)

☒ E27 / 2x max. 11W  
IP44  
anthracite/white



















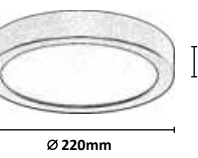

5 998250 386843

**8685** (M) (P)

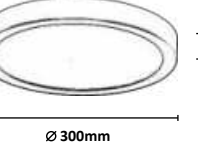
☒ E27 / 2x max. 11W  
IP44  
anthracite/white



5 998250 386850

	<p><b>75071</b></p> <p>LED / 7W                      (3660lm, 3710lm;                      4000K) incl. • IP44                      white</p>	<p>5 years guarantee</p> <p>LED built-in</p> <p>NATURAL White</p> <p>IP44</p> <p>F A ↑ G</p> <p>New</p>	 <p>34mm</p> <p>Ø 120mm</p>	 <p>5 996595 750718</p>
	<p><b>75074</b></p> <p>LED / 7W                      (3660lm, 3710lm;                      4000K) incl. • IP44                      black/white</p>			 <p>5 996595 750749</p>
	<p><b>75077</b></p> <p>LED / 7W                      (3660lm, 3710lm;                      4000K) incl. • IP44                      gold/white</p>			 <p>5 996595 750770</p>
	<p><b>75072</b></p> <p>LED / 24W                      (2600lm, 2800lm;                      4000K) incl. • IP44                      white</p>	<p>5 years guarantee</p> <p>LED built-in</p> <p>NATURAL White</p> <p>IP44</p> <p>F A ↑ G</p> <p>New</p>	 <p>34mm</p> <p>Ø 220mm</p>	 <p>5 996595 750725</p>
	<p><b>75075</b></p> <p>LED / 24W                      (2600lm, 2800lm;                      4000K) incl. • IP44                      black/white</p>			 <p>5 996595 750756</p>
	<p><b>75078</b></p> <p>LED / 24W                      (2600lm, 2800lm;                      4000K) incl. • IP44                      gold/white</p>			 <p>5 996595 750787</p>
	<p><b>75073</b></p> <p>LED / 30W                      (3000lm, 3250lm;                      4000K) incl. • IP44                      white</p>	<p>5 years guarantee</p> <p>LED built-in</p> <p>NATURAL White</p> <p>IP44</p> <p>F A ↑ G</p> <p>New</p>	 <p>34mm</p> <p>Ø 300mm</p>	 <p>5 996595 750732</p>
	<p><b>75076</b></p> <p>LED / 30W                      (3000lm, 3250lm;                      4000K) incl. • IP44                      black/white</p>			 <p>5 996595 750763</p>
	<p><b>75079</b></p> <p>LED / 30W                      (3000lm, 3250lm;                      4000K) incl. • IP44                      gold/white</p>			 <p>5 996595 750794</p>



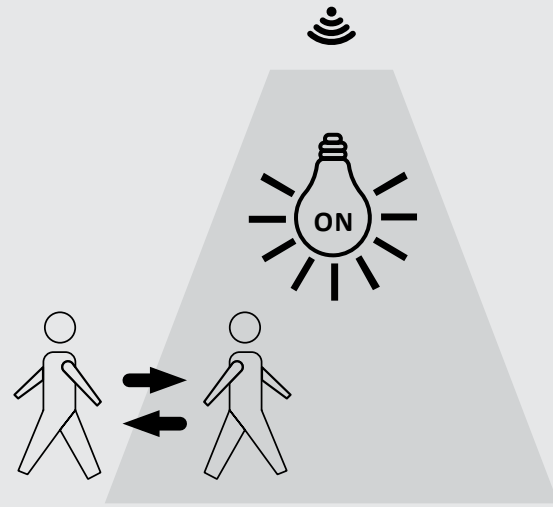
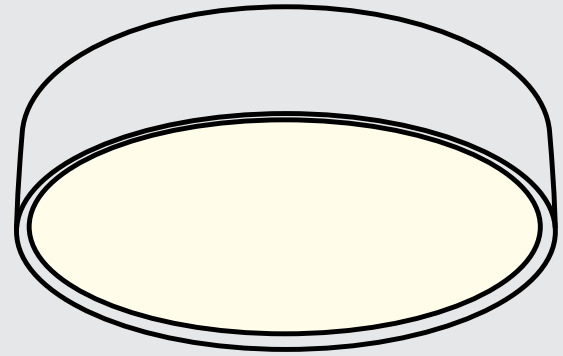
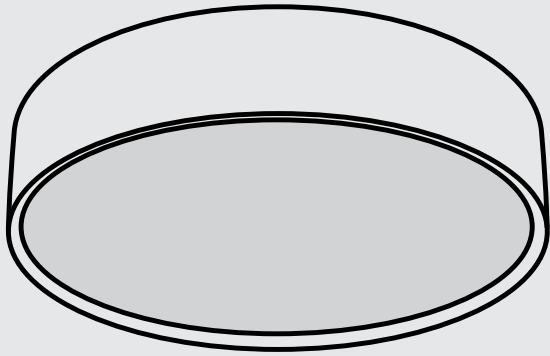

**adjustable • állítható • einstellbar**

	1	2	Detection Area	3	4	5	Hold Time	6	7	8	Daylight Sensor
I	ON	ON	100%	ON	ON	ON	5s	ON	ON	ON	2Lux
II	ON	-	75%	ON	ON	-	30s	ON	ON	-	10Lux
III	-	ON	50%	ON	-	ON	1min	-	ON	-	25Lux
IV	-	-	25%	ON	-	-	3min	ON	-	-	50Lux
V				-	ON	ON	5min	-	-	-	Disable
VI				-	ON	-	10min				
VII				-	-	ON	20min				
VIII				-	-	-	30min				

# LARCIA



**75011**

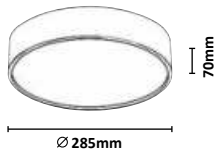

**75012**

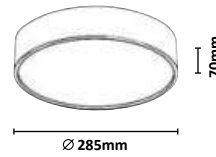

# LUCAS



**71132**



**71133**



**71134**

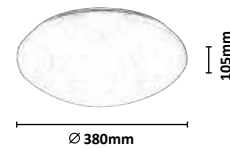

**75011** (P)

LED / 19W  
 (1000lm, 1900lm;  
 4000K) incl. • IP44 • 6m, 120°  
 20010 • black/white



5 996595 750114

**75012** (P)

LED / 19W  
 (1070lm, 1900lm;  
 4000K) incl. • IP44 • 6m, 120°  
 20011 • white



5 996595 750121

**71132** (M P)

LED / 12W  
 (830lm, 1200lm;  
 4000K) incl. • IP44 • 6m, 120°  
 19714 • white



5 996595 711320

**71133** (M P)

LED / 18W  
 (1180lm, 1800lm;  
 4000K) incl. • IP44 • 6m, 120°  
 19715 • white



5 996595 711337

**71134** (M P)

LED / 24W  
 (1750lm, 2400lm;  
 4000K) incl. • IP44 • 6m, 120°  
 19716 • white



5 996595 711344



# LOWAR



**77137**

WARM White

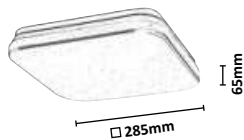

**77138**

NATURAL White



**77139**

WARM White

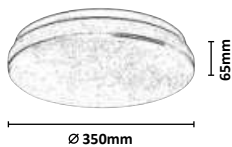

**77140**

NATURAL White

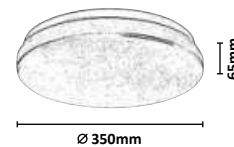

**77137**

(P)

LED / 18W  
 (☰) 1150lm; (☲) 1800lm,  
 3000K incl. • IP44  
 ☰ 5m, 360° • white



5 996595 771379

**77138**

(P)

LED / 18W  
 (☰) 1150lm; (☲) 1800lm,  
 4000K incl. • IP44  
 ☰ 5m, 360° • white



5 996595 771386

**77139**

(P)

LED / 24W  
 (☰) 1450lm; (☲) 2400lm,  
 3000K incl. • IP44  
 ☰ 5m, 360° • white



5 996595 771393

**77140**

(P)

LED / 24W  
 (☰) 1450lm; (☲) 2400lm,  
 4000K incl. • IP44  
 ☰ 5m, 360° • white



5 996595 771409



For sensor-based Lowar products the sensor is operated via a remote control. See the image for remote control usage.

Szenzoros Lowar termékek esetén a szenzor kapcsolása távirányítóval történik. A távirányító használatát lásd a képen.

Bei sensorbasierten Lowar-Produkten wird der Sensor über eine Fernbedienung gesteuert. Die Nutzung der Fernbedienung ist auf dem Bild ersichtlich.

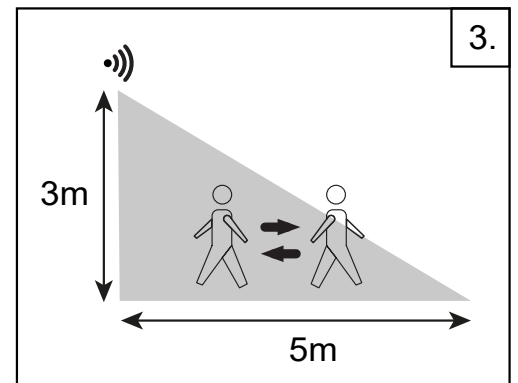
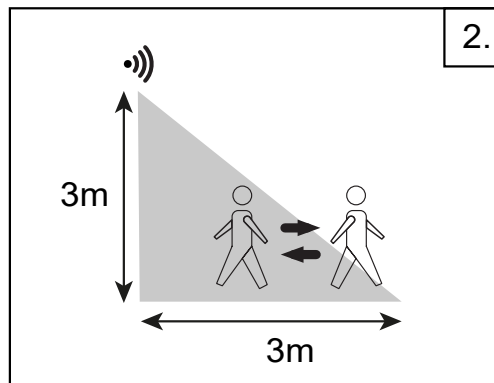
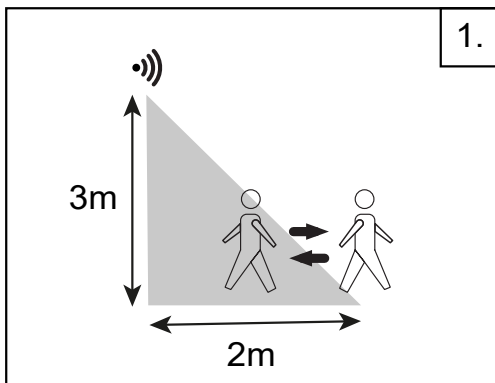
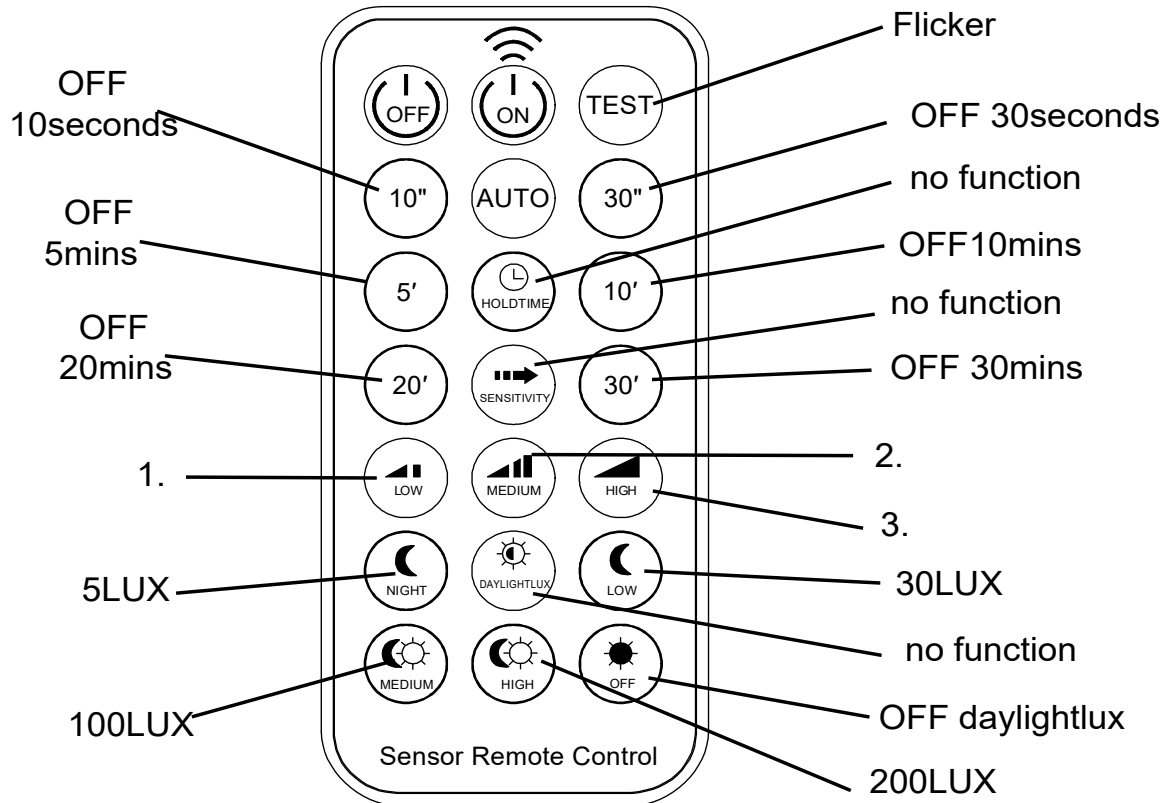



## LONATO



## HITURA



**77213**

**(P)**

LED / 18W  
 (1730lm, 2500lm; 4000K) incl.  
 IP65 • 8m, 120°  
 black/white



5 996595 772130

**77214**

**(P)**

LED / 18W  
 (1730lm, 2500lm; 4000K) incl.  
 IP65 • 8m, 120°  
 white



5 996595 772147

**77028**

**(P)**

LED / 15W  
 (1350lm, 1800lm; 4000K) incl.  
 IP54 • 6±2m, 120°  
 black/white



5 996595 770280

**77029**

**(P)**

LED / 15W  
 (1500lm, 1800lm; 4000K) incl.  
 IP54 • 6±2m, 120°  
 white



5 996595 770297

# HORT



# LENTIL



## 7406 (P)

LED / 15W  
 (1300lm, 1490lm;  
 4000K) incl. • IP54  
 white



5 998250 374062

## 7407 (P)

LED / 15W  
 (1100lm, 1350lm;  
 4000K) incl. • IP54  
 black/white



5 998250 374079

## 7408 (P)

LED / 15W  
 (1300lm, 1490lm;  
 4000K) incl. • IP54  
 white



5 998250 374086

## 7409 (P)

LED / 15W  
 (1100lm, 1350lm;  
 4000K) incl. • IP54  
 black/white



5 998250 374093

## 5810 (P)

E27 / 1x max. 60W  
 IP54  
 white



5 998250 358109



## AMARILLO



7969

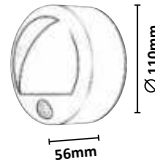

7980



## TRENTO



8893

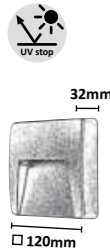

8894

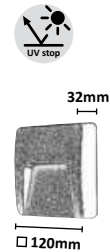

77105



7969



☑ DC 4,5V / LED / 1,5W  
 (☑50lm, ☑90lm; 3000K) incl.  
 3xAAA excl. • IP44  
 ☑ 2-8m, 90° • black/white



5 998250 379692

7980



☑ DC 4,5V / LED / 1,5W  
 (☑50lm, ☑90lm; 3000K) incl.  
 3xAAA excl. • IP44  
 ☑ 2-8m, 90° • white



5 998250 379807

8893



☑ LED / 3W  
 (☑100lm, ☑200lm;  
 4000K) incl. • IP65  
 white



5 998250 388939

8894



☑ LED / 3W  
 (☑100lm, ☑200lm;  
 4000K) incl. • IP65  
 anthracite



5 998250 388946

77105



☑ LED / 4W  
 (☑180lm, ☑400lm;  
 4000K) incl. • IP65  
 anthracite/transparent



5 996595 771058

# KAVALA

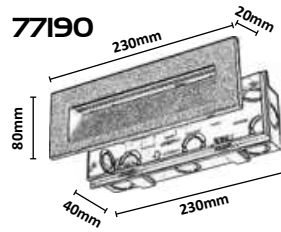
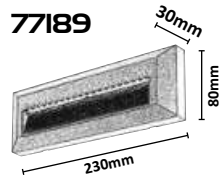

# PUEBLO

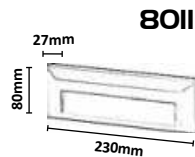

# TACOMA

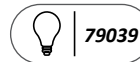

8714

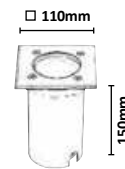

77189

P

LED / 6W  
(300lm, 600lm;  
3000K, 4000K, 6500K) incl. • IP65  
black/transparent



5 996595 771898

77190

P

LED / 6W  
(250lm, 600lm;  
3000K, 4000K, 6500K) incl. • IP65  
black/transparent



5 996595 771904

8011

P

LED / 1,6W  
(103lm, 160lm;  
4000K) incl. • IP65  
grey



5 998250 380117

8714

M G

GU10 / 1x max. 50W  
IP65  
satin chrome



5 998250 387147

A dark, textured background of a stone wall with irregular, layered stones in shades of dark brown and black. The lighting creates subtle highlights and shadows, emphasizing the rough, natural texture of the masonry.

**03**

**CLASSIC PRODUCT FAMILIES**

**KLASSZIKUS TERMÉKCSALÁDOK**

**KLASSISCHE PRODUKTFAMILIEN**



# MONACO



**8181**

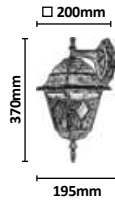

**8184**

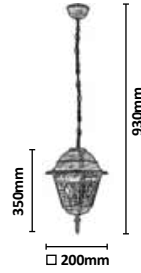

**8182**

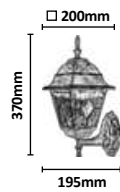

**8185**



**8186**

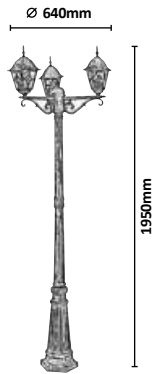

**8181**

**M G**

☒ E27 / 1x max. 60W  
IP43 • 19053  
antique gold/multicolour



5 998250 381817

**8182**

**M G**

☒ E27 / 1x max. 60W  
IP43 • 19053  
antique gold/multicolour



5 998250 381824

**8184**

**M G**

☒ E27 / 1x max. 60W  
IP43 • 19053  
antique gold/multicolour



5 998250 381848

**8185**

**M G**

☒ E27 / 1x max. 60W  
IP43 • 19053  
antique gold/multicolour



5 998250 381855

**8186**

**M G**

☒ E27 / 3x max. 60W  
IP43 • 19053  
antique gold/multicolour



5 998250 381862

# TORONTO



**8381**

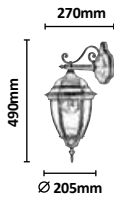

**8460**

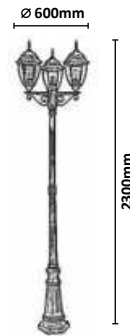

**8381** **M G**

☒ E27 / 1x max. 60W  
IP44 • 9801  
antique gold/transparent



5 998250 383811

**8460** **M G**

☒ E27 / 3x max. 60W  
IP44 • 9801  
antique gold/transparent



5 998250 384603





**8370**

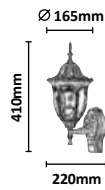

**8376**

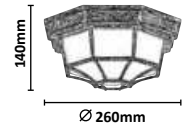

**8371**



**8372**

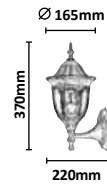

**8370** (M) (G)

☒ E27 / 1x max. 60W  
IP43 • 9449  
☒ 8m, 120°  
antique gold/transparent



5 998250 383705

**8371** (M) (G)

☒ E27 / 1x max. 60W  
IP43 • 9449  
antique gold/transparent



5 998250 383712

**8372** (M) (G)

☒ E27 / 1x max. 60W  
IP43 • 9449  
antique gold/transparent



5 998250 383729

**8376** (M) (G)

☒ E27 / 1x max. 100W  
IP43 • 9446  
antique gold/transparent



5 998250 383767

# MILANO



**8373**



**8374**

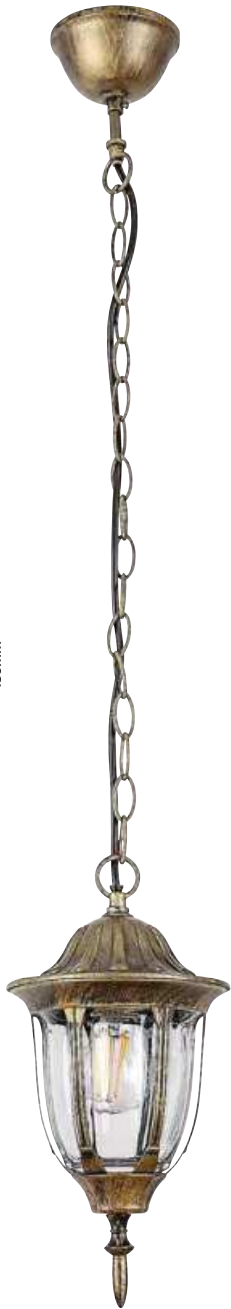
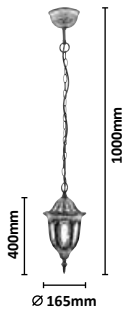

**8375**

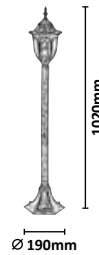

**8373** **MG**

☒ E27 / 1x max. 60W  
IP43 • 9449  
antique gold/transparent



5 998250 383736

**8374** **MG**

☒ E27 / 1x max. 60W  
IP43 • 9449  
antique gold/transparent



5 998250 383743

**8375** **MG**

☒ E27 / 1x max. 60W  
IP43 • 9449  
antique gold/transparent



5 998250 383750

# MILANO



**7837**



**8346**

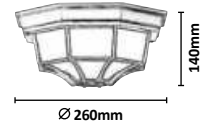

**8341**

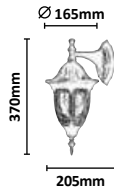

**8342**



**8344**

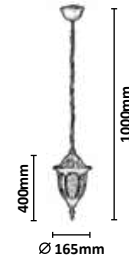

**8345**

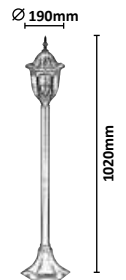

**7837** **MG**

☒ E27 / 1x max. 60W  
IP43 • 9449  
8m, 120°  
black/transparent



5 998250 378374

**8341** **MG**

☒ E27 / 1x max. 60W  
IP43 • 9449  
black/transparent



5 998250 383415

**8342** **MG**

☒ E27 / 1x max. 60W  
IP43 • 9449  
black/transparent



5 998250 383422

**8344** **MG**

☒ E27 / 1x max. 60W  
IP43 • 9449  
black/transparent



5 998250 383446

**8345** **MG**

☒ E27 / 1x max. 60W  
IP43 • 9449  
black/transparent



5 998250 383453

**8346** **MG**

☒ E27 / 1x max. 100W  
IP43 • 9446  
black/transparent



5 998250 383460

# VELENCE



**8204**

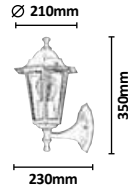

**8202**



**8206**

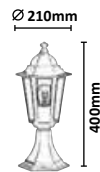

**8208**

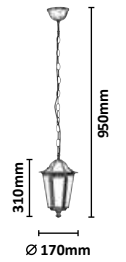

**8217**

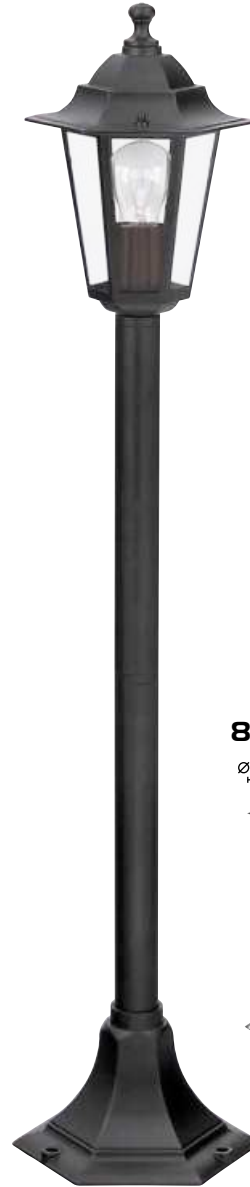
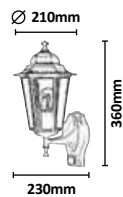

**8210**

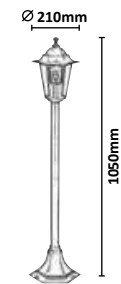

**8202** **M G**

☒ E27 / 1x max. 60W  
IP43 • 9283  
black/transparent



5 998250 382029

**8204** **M G**

☒ E27 / 1x max. 60W  
IP43 • 9283  
black/transparent



5 998250 382043

**8206** **M G**

☒ E27 / 1x max. 60W  
IP43 • 9283  
black/transparent



5 998250 382067

**8208** **M G**

☒ E27 / 1x max. 60W  
IP43 • 9283  
black/transparent



5 998250 382081

**8210** **M G**

☒ E27 / 1x max. 60W  
IP43 • 9283  
black/transparent



5 998250 382104

**8217** **M G**

☒ E27 / 1x max. 60W  
IP43 • 9283  
8m, 120°  
black/transparent



5 998250 382173

# VELENCE



**8203**

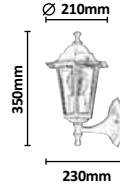

**8201**

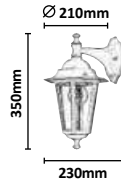

**8205**

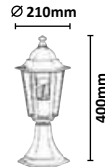

**8207**

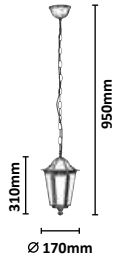

**8216**



**8209**

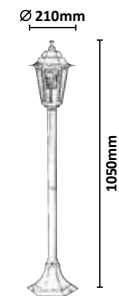

**8201** (M) (G)

☒ E27 / 1x max. 60W  
IP43 • 9283  
white/transparent



**8203** (M) (G)

☒ E27 / 1x max. 60W  
IP43 • 9283  
white/transparent



**8205** (M) (G)

☒ E27 / 1x max. 60W  
IP43 • 9283  
white/transparent



**8207** (M) (G)

☒ E27 / 1x max. 60W  
IP43 • 9283  
white/transparent



**8209** (M) (G)

☒ E27 / 1x max. 60W  
IP43 • 9283  
white/transparent



**8216** (M) (G)

☒ E27 / 1x max. 60W  
IP43 • 9283  
8m, 120°  
white/transparent



# VELENCE



**8234**

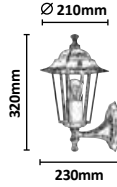

**8218**

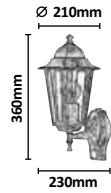

**8236**



**8238**

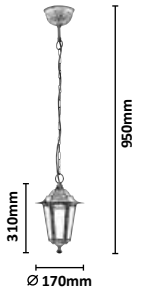

**8232**

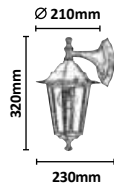

**8240**

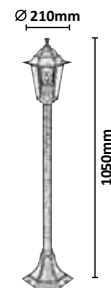

**8218**

**M G**

☒ E27 / 1x max. 60W  
IP43 • 9283  
☑ 8m, 120°  
antique gold/transparent



5 998250 382180

**8232**

**M G**

☒ E27 / 1x max. 60W  
IP43 • 9283  
antique gold/transparent



5 998250 382326

**8234**

**M G**

☒ E27 / 1x max. 60W  
IP43 • 9283  
antique gold/transparent



5 998250 382340

**8236**

**M G**

☒ E27 / 1x max. 60W  
IP43 • 9283  
antique gold/transparent



5 998250 382364

**8238**

**M G**

☒ E27 / 1x max. 60W  
IP43 • 9283  
antique gold/transparent



5 998250 382388

**8240**

**M G**

☒ E27 / 1x max. 60W  
IP43 • 9283  
antique gold/transparent



5 998250 382401

# TOSCANA

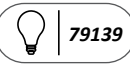

**8391**

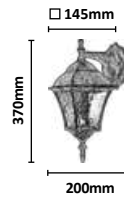

**8392**

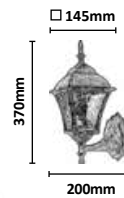

**8395**

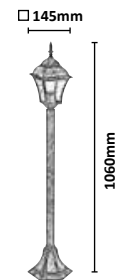

**8394**

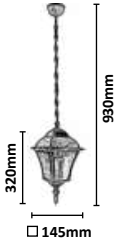

**8391** **M G**

☒ E27 / 1x max. 60W  
IP43 • 19052  
antique gold/transparent



5 998250 383910

**8392** **M G**

☒ E27 / 1x max. 60W  
IP43 • 19052  
antique gold/transparent



5 998250 383927

**8394** **M G**

☒ E27 / 1x max. 60W  
IP43 • 19052  
antique gold/transparent



5 998250 383941

**8395** **M G**

☒ E27 / 1x max. 60W  
IP43 • 19052  
antique gold/transparent



5 998250 383958

# ODESSA

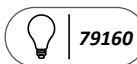

**8163** (M) (P)

☒ E27 / 1x max. 60W  
IP44 • 19447  
antique brown/transparent



**8164** (M) (P)

☒ E27 / 1x max. 60W  
IP44 • 19447  
antique brown/transparent



**8165** (M) (P)

☒ E27 / 1x max. 60W  
IP44 • 19447  
antique brown/transparent





# MADRID

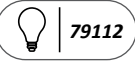

**8476**

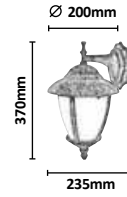

**7836**

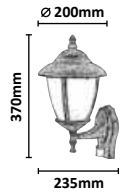

**8377**

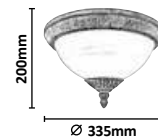

**7836** **MG**

☒ E27 / 1x max. 60W  
IP43 • 9865  
8m, 120°  
antique gold/alabaster



**8377** **MG**

☒ E27 / 2x max. 40W  
IP43 • 9866  
antique gold/alabaster



**8476** **MG**

☒ E27 / 1x max. 60W  
IP43 • 9865  
antique gold/alabaster



# MADRID



**8480**

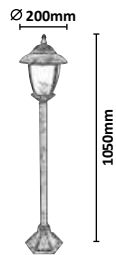

**8379**

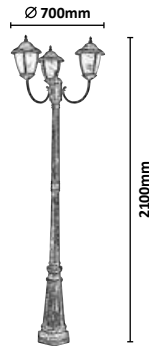

**8379** **MG**

☒ E27 / 3x max. 60W  
IP43 • 9865  
antique gold/alabaster



5 998250 383798

**8480** **MG**

☒ E27 / 1x max. 60W  
IP43 • 9865  
antique gold/alabaster



5 998250 384801

# OSLO



**8737**



760mm

Ø 240mm



**8271**

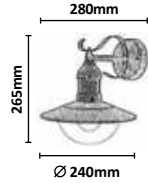

265mm

280mm

Ø 240mm



**8736**

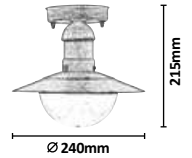

215mm

Ø 240mm



**8739**

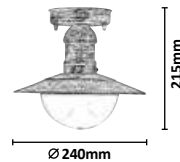

215mm

Ø 240mm



**8681**

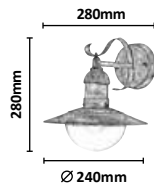

280mm

280mm

Ø 240mm



**8740**

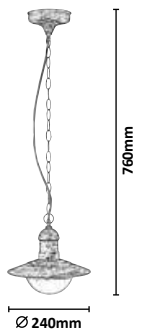

760mm

Ø 240mm

**8271** (M) (P)  
 ☒ E27 / 1x max. 60W  
 IP44 • 19050  
 antique gold/transparent



5 998250 382715

**8681** (M) (P)  
 ☒ E27 / 1x max. 60W  
 IP44 • 19050  
 antique white/transparent



5 998250 386812

**8736** (M) (P)  
 ☒ E27 / 1x max. 60W  
 IP44 • 19050  
 antique gold/transparent



5 998250 387369

**8737** (M) (P)  
 ☒ E27 / 1x max. 60W  
 IP44 • 19050  
 antique gold/transparent



5 998250 387376

**8739** (M) (P)  
 ☒ E27 / 1x max. 60W  
 IP44 • 19050  
 antique white/transparent



5 998250 387390

**8740** (M) (P)  
 ☒ E27 / 1x max. 60W  
 IP44 • 19050  
 antique white/transparent



5 998250 387406

# OSLO



# YAGO



**8270**

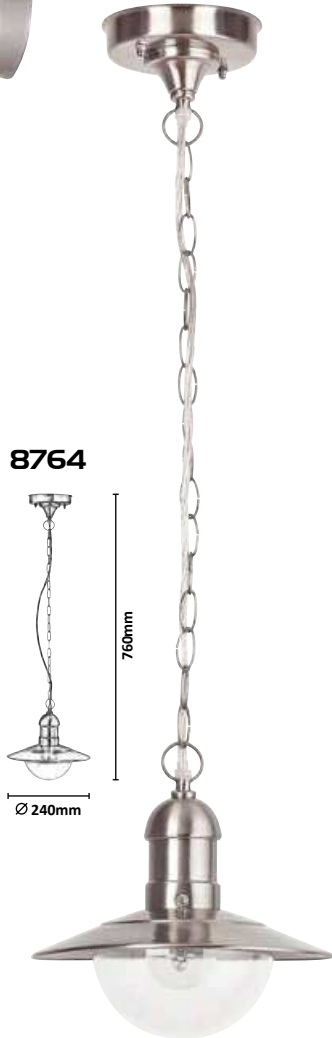
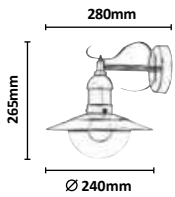

**8764**

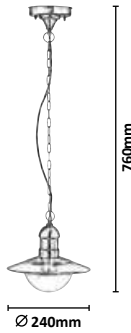

**3309**



**8763**

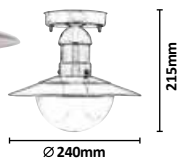

**8270** (M) (P)

☒ E27 / 1x max. 60W  
IP44 • 19050  
satin chrome/transparent



**8763** (M) (P)

☒ E27 / 1x max. 60W  
IP44 • 19050  
satin chrome/transparent



**8764** (M) (P)

☒ E27 / 1x max. 60W  
IP44 • 19050  
satin chrome/transparent



**3309** (M) (G)

☒ E27 / 1x max. 60W  
IP44 • 19984  
chrome/transparent



# OSLO



**8680**

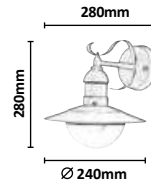

**8682**

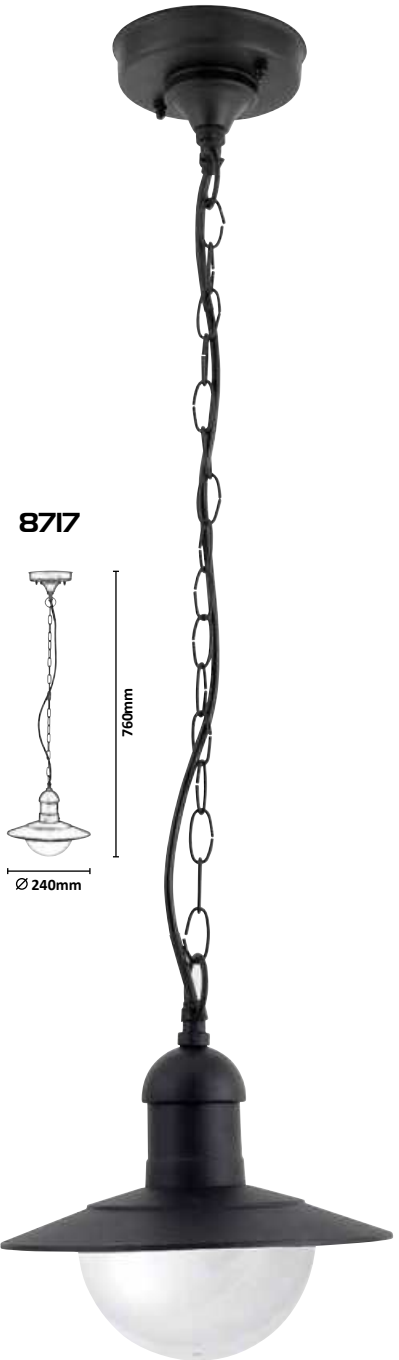
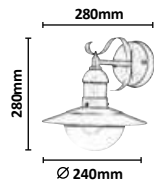

**8717**

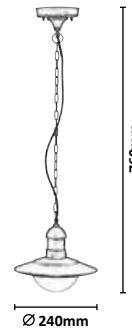

**8716**

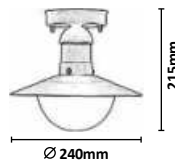

**8680** (M) (P)

☒ E27 / 1x max. 60W  
IP44 • 19050  
black/transparent



5 998250 386805

**8682** (M) (P)

☒ E27 / 1x max. 60W  
IP44 • 19050  
green/transparent



5 998250 386829

**8716** (M) (P)

☒ E27 / 1x max. 60W  
IP44 • 19050  
black/transparent



5 998250 387161

**8717** (M) (P)

☒ E27 / 1x max. 60W  
IP44 • 19050  
black/transparent



5 998250 387178

# VIGO



**8686**

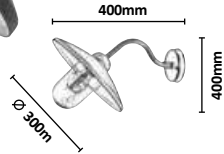

**8687**

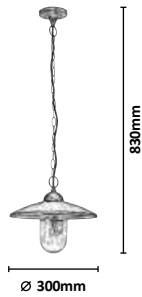

**8686** **M G**

☒ E27 / 1x max. 60W  
IP44 • 19446  
matte black/transparent



5 998250 386867

**8687** **M G**

☒ E27 / 1x max. 60W  
IP44 • 19446  
matte black/transparent



5 998250 386874



## DARIUS



**8190**

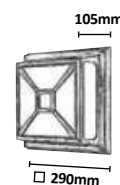

## HEKTOR



**8496**

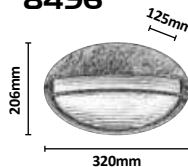

**8499**

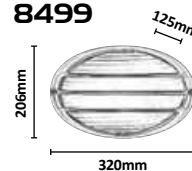

**8190** (M) (P)

☒ E27 / 2x max. 60W  
IP54  
antique gold/white



**8496** (M) (G)

☒ E27 / 1x max. 100W  
IP54 • 9282  
antique gold/transparent



**8499** (M) (G)

☒ E27 / 1x max. 100W  
IP54 • 9282  
antique gold/transparent



# HAGA



8244

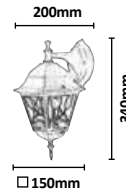

# NORVICH



8753



8754



8244



**8244** (M) (G)

☒ E27 / 1x max. 100W  
IP44 • 19187  
antique gold/transparent



5 998250 382449

**8753** (M) (G)

☒ E27 / 1x max. 60W  
IP43  
19524 • 19523  
antique white/transparent



5 998250 387536

**8754** (M) (G)

☒ E27 / 1x max. 60W  
IP43  
19524 • 19523  
antique gold/transparent



5 998250 387543

# 04

**TABLE, DECORATIVE  
AND SOLAR LAMPS**

**ASZTALI, DEKOR, ÉS NAPELEMES LÁMPÁK**

**TISCH-, DEKOR- UND SOLARLAMPEN**



77146, 77147



# POLPERRO



**77146**

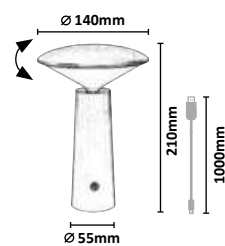

**77147**

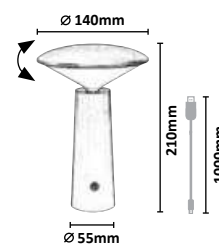

**77146**



DC 5V / LED / 3W (180lm, 250lm; 2800K, 4000K, 6500K) incl. • IP20 DC 3,7V 1200mAh incl. white



**77147**



DC 5V / LED / 3W (180lm, 250lm; 2800K, 4000K, 6500K) incl. • IP20 DC 3,7V 1200mAh incl. black/white



# MIREO



**76036**

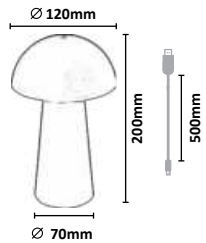

**76038**

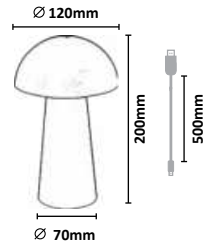

**76037**

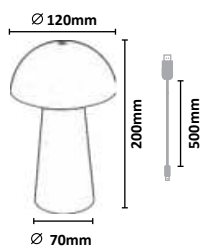

**76039**

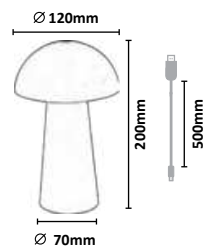

**Charging time: 4h**  
**Working time: 5h**

**76036**



DC 5V / LED 1,5W  
(60lm, 150lm; 3000K) • IP44  
DC 3,7V 1200mAh incl.  
5h • black



5 996595 760366

**76037**



DC 5V / LED 1,5W  
(60lm, 150lm; 3000K) • IP44  
DC 3,7V 1200mAh incl.  
5h • white



5 996595 760373

**76038**



DC 5V / LED 1,5W  
(60lm, 150lm; 3000K) • IP44  
DC 3,7V 1200mAh incl.  
5h • green



5 996595 760380

**76039**



DC 5V / LED 1,5W  
(60lm, 150lm; 3000K) • IP44  
DC 3,7V 1200mAh incl.  
5h • brown



5 996595 760397

77143, 77144, 77145



# FUNES



**77143**

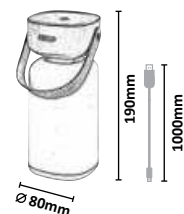

**77144**

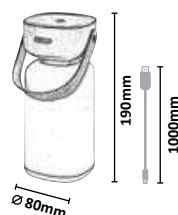

**77145**

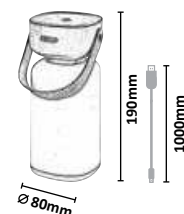

**77143**



DC 5V / LED / 3W (120lm, 150lm; 2800K, 4000K, 6500K) incl. • IP44  
DC 3,7V 120mAh incl.  
brown/white



5 996595 771430

**77144**



DC 5V / LED / 3W (120lm, 150lm; 2800K, 4000K, 6500K) incl. • IP44  
DC 3,7V 120mAh incl.  
green/white



5 996595 771447

**77145**



DC 5V / LED / 3W (120lm, 150lm; 2800K, 4000K, 6500K) incl. • IP44  
DC 3,7V 120mAh incl.  
blue/white



5 996595 771454

# ODERA

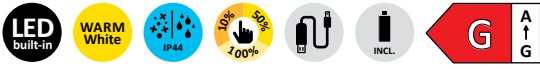

7040

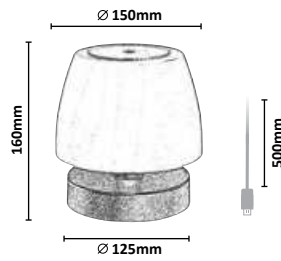

7040



# BURDUR



77142

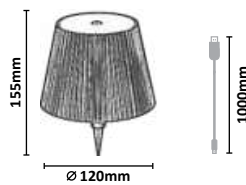

77142



7040



DC 5V / LED / 3W  
 (140lm, 360lm; 3000K) incl.  
 DC 3,7V 2000mAh incl. • IP44  
 black/white



5 998250 370408

77142



DC 5V / LED / 2W  
 (180lm, 270lm; 3000K) incl.  
 DC 3,7V 2000mAh incl. • IP44  
 black/transparent



5 996595 771423

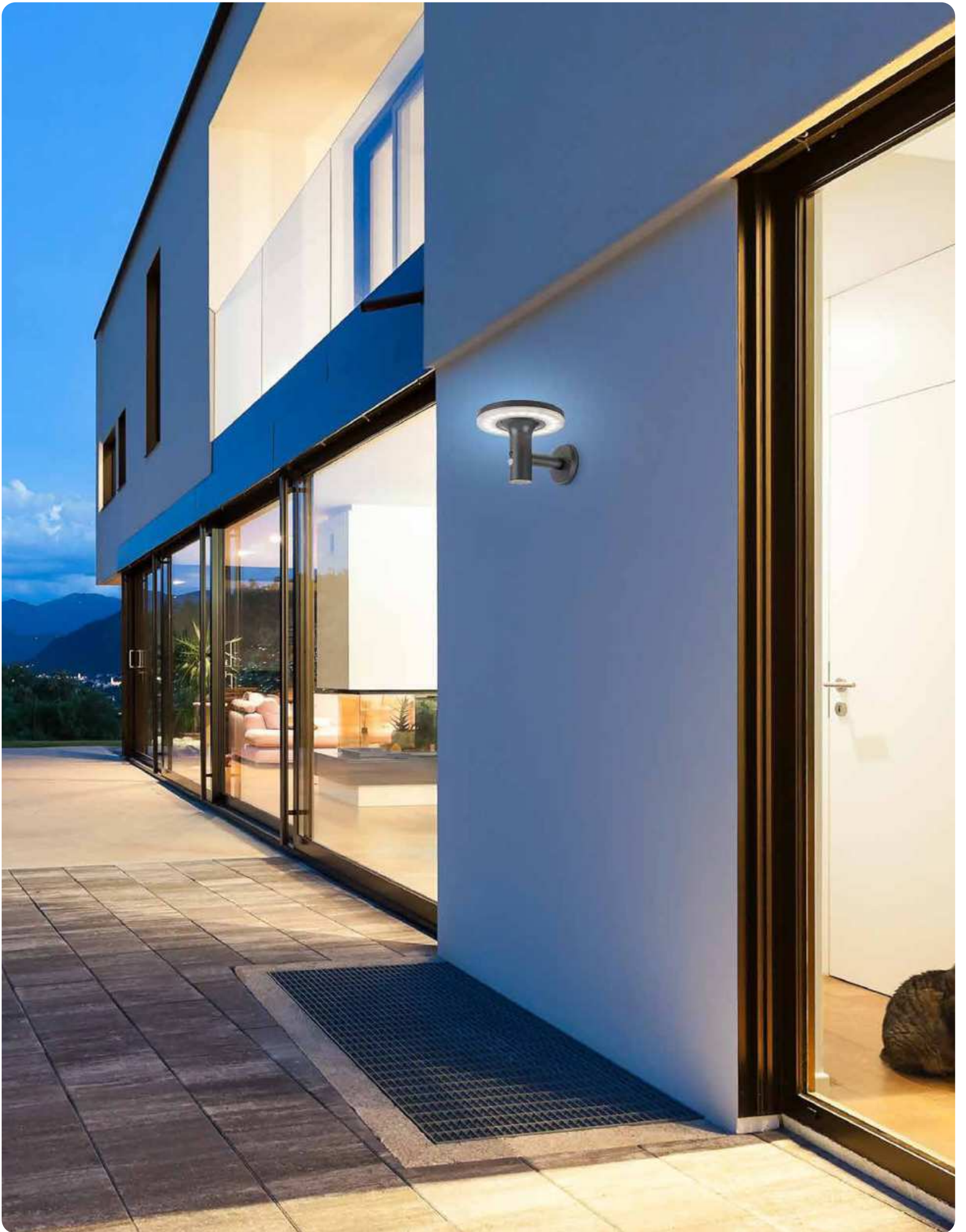

# ALASKA



# LASSET

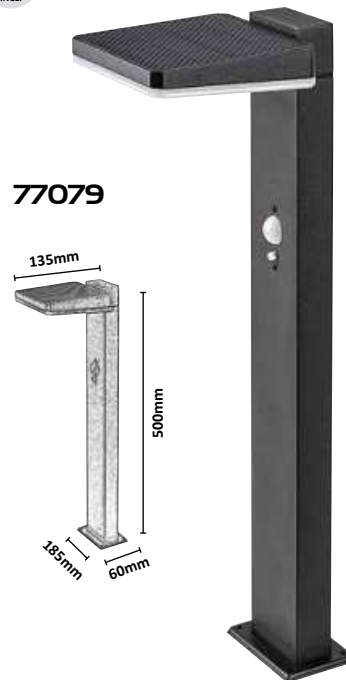

## 77017 (M) (P)

LED / 10W (250lm, 300lm; 4000K) incl.  
DC 3,7V 2500mAh incl.  
IP44 • 5-8m, 120°  
anthracite/white



## 77018 (M) (P)

LED / 10W (250lm, 300lm; 4000K) incl.  
DC 3,7V 2500mAh incl.  
IP44 • 5-8m, 120°  
anthracite/white



## 77078 (M) (P)

LED / 4,4W (200lm, 600lm;  
4000K) incl. • IP54 • 8m, 110°  
DC 3,7V 2200mAh  
black/white



## 77079 (M) (P)

LED / 4,4W (200lm, 600lm;  
4000K) incl. • IP54 • 8-12m, 110°  
DC 3,7V 2200mAh  
black/white



## MOSELLE



77014

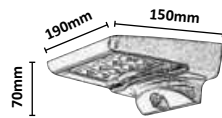

## QESA



77005



## KANGTON



77024

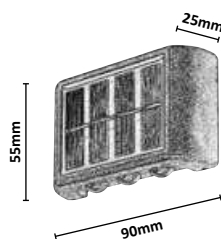

## LERMOS



77203

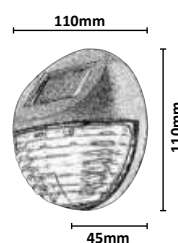

## NARMADA



77004

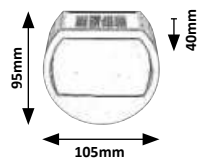

### 77014 (P)

LED / 4W (300lm, 350lm; 4000K) incl. • DC 3,7V 15000mAh incl. IP44 • 5-8m, 120° black/white



5 996595 770143

### 77005 (P)

LED / 10W (460lm, 300lm; 4000K) incl. • DC 3,7V 1200mAh incl. IP44 • 3-5m, 120° black/white



5 996595 770051

### 77024 (P)

LED / 1,2W (8lm, 20lm; 3000K) incl. DC 1,2V 600mAh incl. • IP44 black



5 996595 770242

### 77203 (P)

LED / 0,06W (3lm, 5lm; 3000K) incl. • DC 1,2V 300mAh incl. 8h • IP44 black/transparent



5 996595 772031

### 77004 (P)

LED / 0,5W (13lm, 20lm; 4000K) incl. DC 1,2V 600mAh incl. • IP44 black/white



5 996595 770044

## SEPIK



7701B

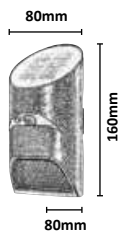

## KAPUAS



77015

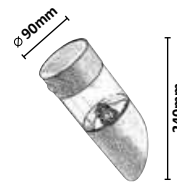

## BREZNO



77006

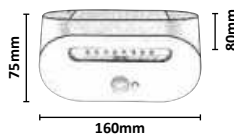

## LUTTO

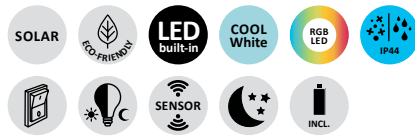

77030

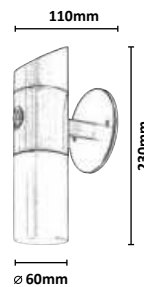

77030



7701B



LED / 3,6W (150lm, 260lm; 4000K) incl.  
DC 3,7V 1800mAh incl.  
IP44 • 3-5m, 120°  
black/white



5 996595 770136

77015



LED / 1,5W (100lm, 130lm; 4000K) incl.  
DC 3,7V 600mAh incl.  
IP44 • 5-8m, 120°  
black/transparent



5 996595 770150

77006



LED / 3,2W (145lm, 200lm; 4000K) incl. • DC 3,7V 1200mAh incl.  
IP44 • 3-5m, 120°  
black/white



5 996595 770068

77030



LED / 1W (65lm, 90lm; 6500K) incl. • IP44 • 10m, 90°  
DC 3,7V 1200mAh  
black/white



5 996595 770303

77205



# MONTORO

- SOLAR
- ECO-FRIENDLY
- LED built-in
- WARM White
- IP44
- Lightbulb icon
- 2 PCS / SET
- INCL.
- Product icon
- New



77205

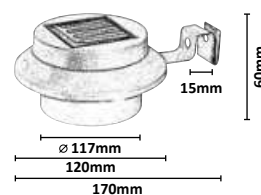

# ISPRA

- SOLAR
- ECO-FRIENDLY
- LED built-in
- WARM White
- IP44
- Lightbulb icon
- 4 PCS / SET
- INCL.
- Product icon
- New



77166

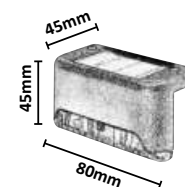

77166



**77205** (P)

LED / 0,06W  
 (3lm, 5lm; 3000K) incl.  
 DC 1,2V 300mAh incl. • IP44  
 8h • white



**77166** (P)

LED / 0,06W  
 (2lm, 3lm; 3000K) incl.  
 DC 1,2V 300mAh incl. • IP44  
 8h • black/transparent



# OSTRAVA



**7880**



**7881**

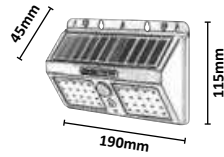

# OPAVA



**7970**

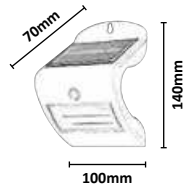

**7880** P

☑ LED / 1,3W  
 (☉100lm, ☉103lm; 4000K) incl.  
 DC 3,7V incl. • IP44  
 ☑ 0-3m, 120° • black



5 998250 378800

**7881** P

☑ LED / 2,4W  
 (☉225lm, ☉250lm; 4000K) incl.  
 DC 3,7V incl. • IP44  
 ☑ 0-3m, 120° • black



5 998250 378817

**7970** P

☑ LED / 2W  
 (☉115lm, ☉120lm; 4000K) incl.  
 DC 3,7V incl. • IP44  
 ☑ 2-8m, 90° • white



5 998250 379708

77159, 77160



# TARCAL



## 77159 PG

LED / 6W (1000lm, 1300lm; 3000K, 4000K, 6500K) incl. • IP65  
3m, 120° • DC 3,7V 2200mAh  
black/white



5 996595 771591

## 77160 PG

LED / 8W (1200lm, 1500lm; 3000K, 4000K, 6500K) incl. • IP65  
3m, 120° • DC 3,7V 2600mAh  
black/white



5 996595 771607

# FLAXTON



**77040**

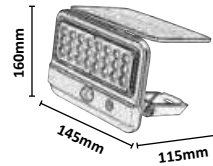

**77090**

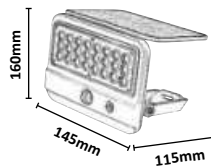

## 77040, 77090

### Mode A

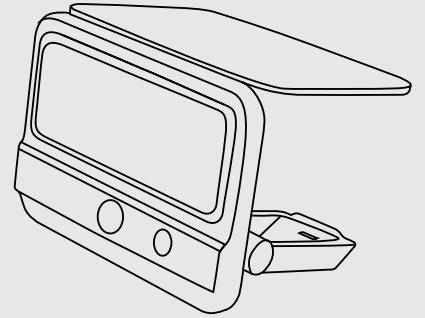

### Mode B

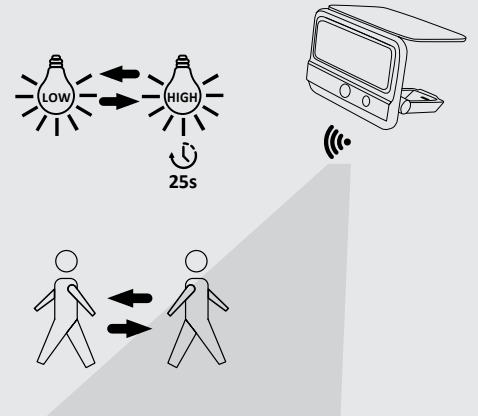

### Mode C

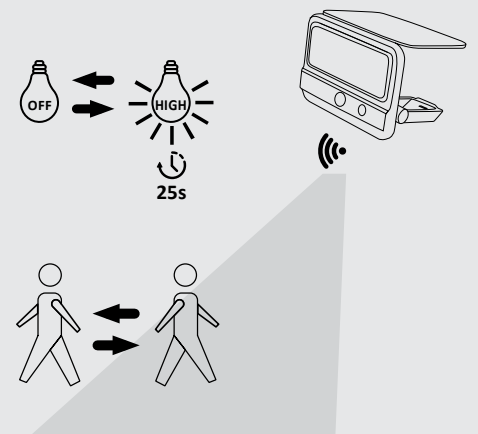

#### 77040



LED / 7W (700lm, 800lm;  
4000K) incl. • IP54  
3-5m, 120° • DC 3,7V 3000mAh  
black/transparent



5 996595 770402

#### 77090



LED / 7W (700lm, 800lm;  
4000K) incl. • IP54  
3-5m, 120° • DC 3,7V 3000mAh  
white/transparent



5 996595 770907



# LIHULL

SOLAR

ECO-FRIENDLY

LED  
built-in

NATURAL  
White

IP44

SENSOR

INCL.



77020

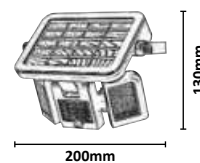

77020 **P**

LED / 9,6W (500lm, 600lm;  
4000K) incl. • IP44 • 5-8m, 120°  
DC 3,7V 3000mAh incl.  
black/transparent



5 996595 770204

## MELK



7714I

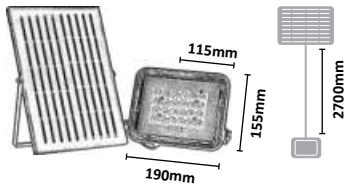

## VALPOVO



77019

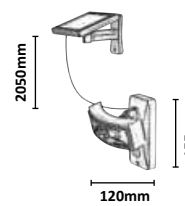

## ZAVOD



77129

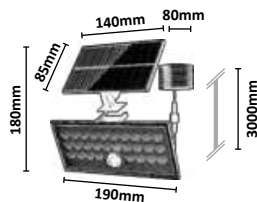

## ZLARIN



77012

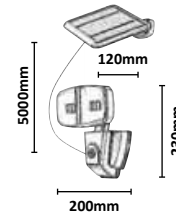

7714I



7714I



☑ LED / 6,5W (☉1000lm, ☉1050lm; 3000K, 4000K, 6500K) incl. • IP65  
🔋 568 • DC 3,2V 1000mAh (3,7V DC) incl.  
black/transparent



5 996595 771416

77019



☑ LED / 2,4W (☉250lm, ☉300lm; 4000K) incl.  
DC 3,7V 1200mAh incl.  
IP44 • 📏 5-8m, 120°  
black/transparent



5 996595 770198

77129



☑ LED / 8W (☉800lm, ☉880lm; 5000K) incl. • IP65 • 📏 8m, 120°  
🔋 579 • DC 3,7V 1800mAh  
black/transparent



5 996595 771294

77012



☑ LED / 12W (☉700lm, ☉800lm; 4000K) incl.  
DC 3,7V 4000mAh incl.  
IP44 • 📏 5-8m, 120°  
black/white



5 996595 770129

# — SAVOCA —



**77167**

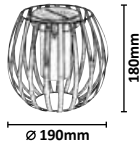

# — YOLA —

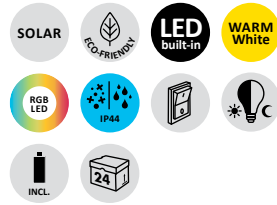

**7850**



# — TAPOLCA —



**77176**



# — SLUIS —



**77046**

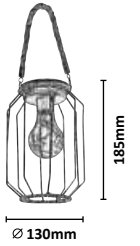

**77167** (M) (P)

LED / 1W  
(5lm, 8lm; 3000K) incl.  
IP44 • DC 1,2V 300mAh  
black/white



5 996595 771676

**7850** (M) (G)

RGB LED / 0,06W  
(11lm, 6lm; 3000K) incl.  
DC 1,2V 60mAh incl.  
IP44 • • satin chrome/transparent



5 998250 378503

**77176** (M)

LED / 0,16W  
(2lm, 5lm; 3000K) incl.  
IP44 • DC 1,2V 400mAh  
white



5 996595 771768

**77046** (M) (P)

LED / 0,2W  
(3lm, 5lm; 3000K) incl.  
IP44 • DC 1,2V 600mAh  
black/transparent



5 996595 770464

## TRILLO



77175



## HOLNE



77188

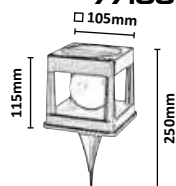

## BOKOD



77187

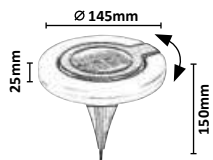

## DANNET



7975

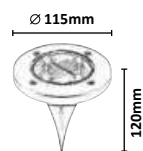

77187



77175

(P)

LED / 0,3W  
 (15lm, 17lm; 4000K) incl.  
 DC 1,2V 800mAh incl. • IP65  
 transparent



5 996595 771751

77188

(P)

LED / 0,3W  
 (6lm, 16lm; 2500K-3000K) incl.  
 DC 3,7V 800mAh incl. • IP44  
 black/white



5 996595 771881

77187

(P)

LED / 0,05W  
 (5lm, 7lm; 2500K-3000K) incl.  
 DC 1,2V 300mAh incl. • IP44  
 black/white



5 996595 771874

7975

(M)(P)

LED / 0,24W  
 (20lm, 25lm; 3000K)  
 DC 1,2V 400mAh incl. • IP44  
 satin chrome/ black



5 998250 379753



# MORA



**8948**

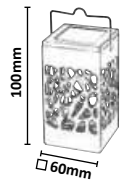

**8949**

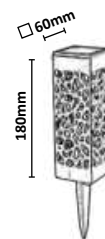

**8948**

**P**

☑ LED / 0,07W  
 (☑11lm, ☑3lm; 3000K) incl.  
 DC 1,2V 200mAh incl. • ☑  
 IP23 • black



5 998250 389486

**8949**

**P**

☑ LED / 0,16W  
 (☑21lm, ☑41lm; 3000K) incl.  
 DC 1,2V 400mAh incl. • ☑  
 IP23 • black



5 998250 389493

# KROBIA



**7814**

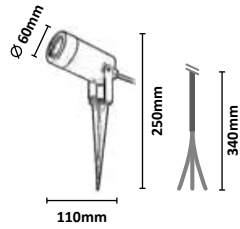

# NANTES



**77088**

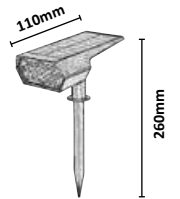

# TURDA



**7060**

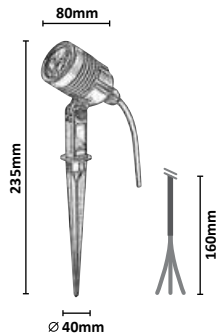

# KELNA



**77011**

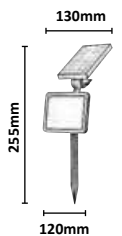

**7814**



☒ GU10 / 1x max. 4W  
IP65  
black/transparent



5 998250 378145

**7060**



☒ LED / 3W  
(☒260lm, ☒360lm;  
4000K) incl. • IP65  
black/transparent



5 998250 370606

**77088**



☒ LED / 0,5W  
(☒50lm, ☒250lm; 3000K) incl.  
IP65 • DC 3,7V 1500mAh  
black/transparent



5 996595 770884

**77011**



☒ LED / 9,6W  
(☒200lm, ☒240lm; 4000K) incl.  
DC 3,7V 2000mAh incl. • IP44  
black/white



5 996595 770112



## CONG



77186

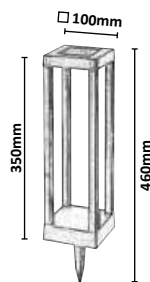

## FUNGHETTO



7877

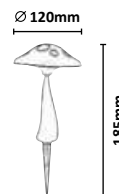

## RAVELLO



77158

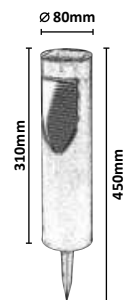

77186



LED / 0,18W  
 (6lm, 7lm; 4000K) incl.  
 DC 3,7V 500mAh incl. • IP44  
 black



5 996595 771867

7877



LED / 0,06W  
 (3000K) incl.  
 DC 1,2V 300mAh incl. •   
 IP44 • red/white



5 998250 378770

77158



LED / 0,1W  
 (5lm, 10lm; 3000K) incl.  
 DC 1,2V 600mAh incl. • IP44  
 black



5 996595 771584

# MONOR



77177

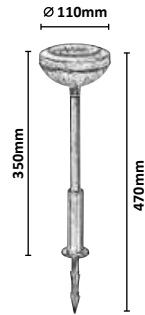

# SOLAR 1



8365

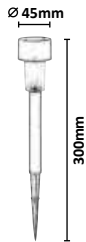

8366

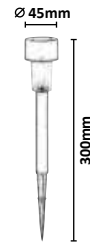

77177



77177

P

LED / 0,1W  
(11lm, 15lm; 3000K) incl.  
DC 1,2V 600mAh incl. • IP44  
black/transparent



5 996595 771775

8365

P

LED / 0,1W incl.  
(11lm, 15lm)  
DC 1,2V 40mAh incl.  
IP44 • black



5 998250 383651

8366

M P

LED / 0,1W incl.  
(11lm, 15lm)  
DC 1,2V 40mAh incl.  
IP44 • satin chrome/stainless steel



5 998250 383668

# TAVIRA

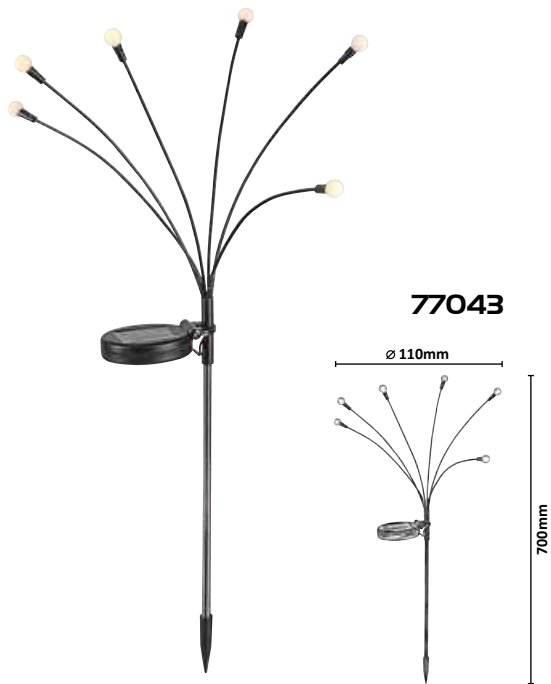

# ZIRC



## 77043



LED / 0,06W  
 (33lm, 35lm; 3000K) incl.  
 DC 1,2V 300mAh incl. • IP44  
 8h • black/white



5 996595 770433

## 77165



LED / 3,6W  
 (35lm, 40lm; 2700K) incl.  
 IP44 • DC 3,7V 1200mAh  
 black/transparent



5 996595 771652



# WIGRY



77001

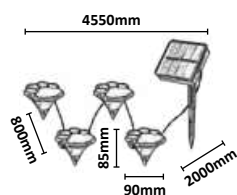

# BOBUS

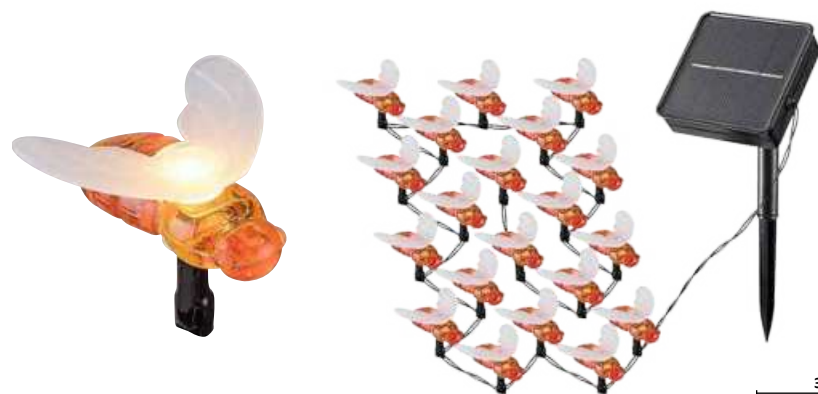

77002

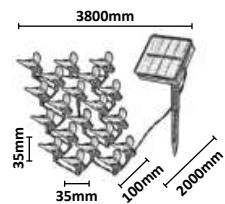

77001

(P)

LED / 0,06W  
 (3lm, 8lm; 3000K) incl.  
 DC 1,2V 600mAh incl. • IP44  
 black/white



5 996595 770013

77002

(P)

LED / 0,06W  
 (3lm, 8lm; 2700K) incl.  
 DC 1,2V 600mAh incl. • IP44  
 black/white



5 996595 770020



# ANSOO



77016

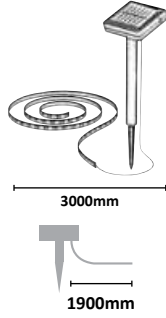

# BIRI



77123

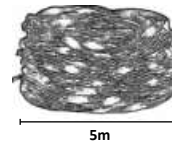

5m

77124

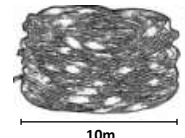

10m



77016



LED / 0,26W  
 (30lm, 35lm; 3000K) incl.  
 DC 3,2V 400mAh incl. • IP44  
 white



5 996595 770167

77123



RGB LED / DC 5V / 2,8W  
 IP44  
 554  
 transparent/white



5 996595 771232

77124



RGB LED / DC 5V / 3,2W  
 IP44  
 554  
 transparent/white



5 996595 771249

# LED STRIP



**79021**

F A ↑ G

RGB LED NATURAL White

IP67 InfraRed Remote

6,25 cm 192 SMD/m

9,8mm

5000mm

1500mm

## 79022, 79023



**79022**

RGB LED IP44

10 cm 30 SMD/m

**79023**

RGB LED

10 cm 30 SMD/m

2mm

5000mm

1500mm

**79021** (P)  
LED / AC 230V / 21W  
(2000lm; 4000K) incl.  
15.000h • IP67 • 576



**79022** (P)  
RGB LED / DC 12V / 19W  
CR2025 incl.  
25.000h • IP44 • 577



**79023** (P)  
RGB LED / DC 12V / 19W  
CR2025 incl.  
25.000h • IP20 • 578





## EXTRA FEATURES • EXTRA FUNKCIÓK • EXTRA FUNKTIONEN



Our SMART marked lights can be controlled via the TUYA app available on your smartphone or tablet. The app makes it simple and easy to change the colour temperature and brightness of the lamp, so you can quickly and easily adjust the light to the mood of the occasion during a garden party!



SMART jelöléssel ellátott lámpáink okostelefonon vagy táblagépen elérhető TUYA applikáción keresztül vezérelhetők. Az alkalmazással egyszerűen és könnyedén változtatható a lámpa színhőmérséklete és fényereje, így egy kerti összejövetel közben egyszerűen és gyorsan az adott hangulathoz igazítható a lámpa fénye!



Unsere SMART-gekennzeichneten Leuchten können über die TUYA-App gesteuert werden, die auf Ihrem Smartphone oder Tablet verfügbar ist. Mit der App können Sie ganz einfach die Farbtemperatur und die Helligkeit der Lampe ändern. So können Sie das Licht bei einer Gartenparty schnell und einfach an die Stimmung des Anlasses anpassen!





**Colour Temperature:** LED lamps offer three options: cool, natural, and warm white. Adjustable colour temperature lamps allow you to adapt the light to your activity or mood. Warm white is ideal for relaxation, while cool white suits tasks requiring focus. CCT lamps let you adjust the colour temperature any time after installation, while CCT SWITCH lamps require selection before installation.



**Színhőmérséklet:** A LED lámpák három színhőmérsékletet kínálnak: hideg, természetes és meleg fehér. Az állítható színhőmérsékletű lámpák lehetővé teszik a fény hangulathoz vagy tevékenységhez igazítását. A meleg fehér relaxációhoz, a hideg fehér pedig koncentrációt igénylő feladatokhoz ideális. CCT lámpák esetén a színhőmérséklet utólag is állítható, míg CCT SWITCH lámpáknál ezt felszerelés előtt kell beállítani.



**Farbtemperatur:** LED-Lampen bieten drei Farbtemperaturen: kaltweiß, neutralweiß und warmweiß. Lampen mit einstellbarer Farbtemperatur ermöglichen die Anpassung des Lichts an Stimmung oder Aktivität. Warmweiß eignet sich für Entspannung, kaltweiß für Aufgaben, die Konzentration erfordern. Bei CCT-Lampen kann die Farbtemperatur nach der Installation angepasst werden, während sie bei CCT SWITCH-Lampen vor der Montage eingestellt werden muss.



**RGB:** RGB (Red-Green-Blue) lighting means that the lamp contains red, green, and blue chips, creating colourful mood lighting. This feature offers creative and unique lighting options and is perfect for creating special light shows.



**RGB:** Az RGB (Red-Green-Blue) világítás alatt azt értjük, hogy az adott lámpa vörös, zöld és kék chipeket tartalmaz, melyek színes hangulatvilágítást eredményeznek. Ez a funkció kreatív és egyedi megvilágítási lehetőségeket kínál, és alkalmas lehet különleges fényjátékok létrehozására.



**RGB:** RGB (Rot-Grün-Blau) Beleuchtung bedeutet, dass die Lampe rote, grüne und blaue Chips enthält, die eine farbenfrohe Stimmungsbeleuchtung erzeugen. Diese Funktion bietet kreative und einzigartige Beleuchtungsmöglichkeiten und eignet sich perfekt für spezielle Lichtspiele.



**Dimming:** Dimming refers to the ability to adjust the lamp's brightness. This can be done in a gradual or continuous manner, using various methods such as switches, touch controls, remote controls, or even apps.



**Fényerő-szabályozás:** A dimmelhetőség a lámpa fényerősségének változtatását jelenti. Ennek módja lehet fokozatos vagy folyamatos, valamint különböző módon történhet: kapcsolóval, érintéssel, távirányítóval, vagy akár applikációval



**Dimmbarkeit:** Dimmbarkeit bezeichnet die Möglichkeit, die Helligkeit der Lampe anzupassen. Dies kann stufenweise oder kontinuierlich erfolgen, und zwar auf unterschiedliche Weise: mit Schaltern, Berührung, Fernbedienung oder sogar per App.





# INFORMATION BLOCK • INFORMÁCIÓS BLOKK • INFORMATIONSBLOCK

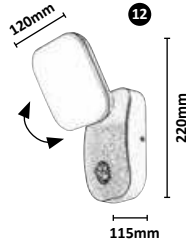

1 **9999** 2 **MT**

3 LED / 50W (3080lm, 3000K-6000K) incl.

4 E27 / 1x max. 60W

5 IP20 • 6 19500 • 7 523

8 • DC 1,2V • 9 1xAA incl.

10 white

11   
5 998250 362502

- 1
- Item No.
  - cikkszám
  - Artikelnummer
  - no. article
  - objednací číslo
  - Číslo položky
  - nr artykułu
  - номер виробу
  - nr. Articol
  - Br. Artikla
  - broj artikla
  - številka artikla / artikel št.
  - № на артикул
  - elemento Nr.
  - izstrādājuma Nr.
  - toote Nr.

- 2
- material of the product
  - a termék anyaga
  - Material des Produkts
  - matériau du produit
  - materiál výrobku
  - material výrobu
  - Material produktu
  - материал виробу
  - materialul produsului
  - materijal proizvoda
  - materijal proizvoda
  - material izdelka
  - материал на продукта
  - produkto medžiaga
  - produkta materiāls
  - toote materjal

- 3
- technical data of lightsource for lamp
  - a lámpához adott fényforrás műszaki adatai
  - Technische Daten des Leuchtmittels zur Leuchte
  - caractéristiques techniques de l'ampoule du luminaire
  - technické údaje světelného zdroje dodávaného s lampou
  - technické údaje zdroja svetla priloženého k lampe
  - dane techniczne źródła światła dostarczonego z lampą
  - технічні дані джерела освітлення для даної лампи
  - datele tehnice ale sursei de lumină pentru lampă
  - tehnički podaci o izvoru svetlosti za lampu
  - tehnički podaci izvora svetlosti koji je priložen uz lampu
  - tehnični podatki vira svetlobe za svetilko
  - технически данни на източника на светлина, приложен към лампата
  - šviestuvo šviesos šaltinio techniniai duomenys
  - lampas gaismas avota tehniskie dati
  - lambi valgusallika tehnilised andmed

- 4
- the specifications of the lightsource
  - a fényforrásra vonatkozó műszaki adatok
  - Angaben zur Lichtquelle
  - les spécifications de la source lumineuse
  - specifikace světelného zdroje
  - specifikácie svetelného zdroja
  - Specyfikacja źródła światła
  - технічні характеристики джерела освітлення
  - specificații sursă de iluminat
  - specifikacije svetlosnog izvora
  - specifikacija izvora svjetlosti
  - specifikacije svetlobnega vira
  - характеристики на светлинния източник
  - šviesos šaltinio specifikacijos
  - gaismas avota specifikācijas
  - valgusallika tehnilised andmed

- 5
- IP protection
  - IP védettség
  - IP-Klasse
  - protection IP
  - IP kryti
  - IP ochrana
  - Stopień ochrony IP
  - Клас IP-защиты
  - Protectia IP
  - IP zaštita
  - IP zaštita
  - IP zaštita
  - с IP защита
  - IP klasė
  - IP aizsardzība
  - IP kaitse

- 6
- article number of the replacement lampshade
  - pótbúra cikkszám
  - Artikelnummer des Ersatz-Lampenschirms
  - numéro d'article de l'abat-jour de remplacement
  - číslo výrobku náhradního stínítka
  - číslo výrobku náhradného tienidla
  - Numer artykułu wymiennego klosza
  - номер виробу запасного абажура
  - număr de articol pentru abajurul înlocuitor
  - Br. artikla rezervnog abažura
  - broj artikla zamjenskog sjenila
  - številka izdelka nadomestnega senčila
  - № на артикул на допълнителен абажур
  - pakaitinio lempos gaubto prekės numeris
  - rezerves abažūra precēs numurs
  - asenduslambivarju artiklinumber

- 7
- item number remote controller
  - a távirányító cikkszám
  - Artikelnummer der Fernbedienung
  - numéro d'article de la télécommande
  - Číslo položky dálkového ovladače
  - Číslo položky diaľkového ovládača
  - Numer produktu pilota
  - Номер елемента дистанційного керування
  - Număr articol pe telecomandă
  - Broj stavke daljinskog upravljača
  - Broj stavke daljinskog upravljača
  - Številka izdelka daljinskega upravljalnika
  - Kataložen numer na дистанционното управление
  - Nuotolinio valdymo pulto prekės numeris
  - Tālvadības pults vienuma numurs
  - Pulti artiklinumber

- 8
- type of switch
  - a kapcsoló típusa
  - Typ des Schalters
  - type d'interrupteur
  - druh vypínače
  - druh vypínača
  - Typ przelącznika
  - тип перемикача
  - tip de comutator
  - tip prekidača
  - vrsta prekidača
  - vrsta stikala
  - тип на ключа
  - jungiklio tipas
  - sledža tips
  - lüliti tüüp











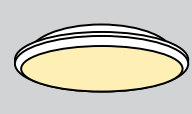
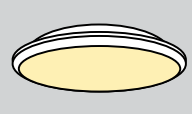

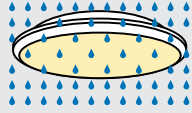
- 9
- battery specification
  - elemmel kapcsolatos információk
  - Batteriespezifikation
  - spécifications de la pile
  - specifikace baterie
  - specifikácia batérie
  - Specyfikacja baterii
  - специфікація акумулятора
  - specificații baterie
  - specifikacija baterije
  - specifikacija baterije
  - specifikacija baterij
  - характеристики на батерията
  - baterijos specifikacijos
  - baterijas specifikācija
  - patarei tehnilised andmed

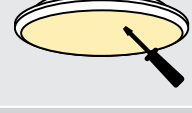
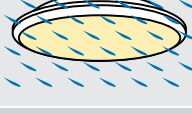
- 10
- colour of the product
  - a termék színe
  - Farbe des Produkts
  - couleur du produit
  - boja produktu
  - farba produktu
  - Kolor produktu
  - колір виробу
  - culoarea produsului
  - boja proizvoda
  - boja proizvoda
  - barva izdelka
  - цвят на продукта
  - produkto spalva
  - produkta krāsa
  - toote värv

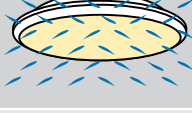
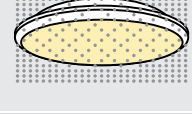
- 11
- EAN code
  - EAN- kód
  - EAN-Code
  - code EAN
  - EAN- kód
  - EAN- kód
  - kod EAN
  - код EAN
  - cod EAN
  - EAN kód
  - EAN- kod
  - EAN koda
  - EAN kod
  - EAN kodas
  - EAN kods
  - EAN-kood

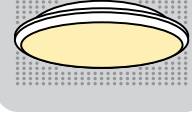
- 12
- sizes
  - méretek
  - Maß
  - dimensions
  - rozměry
  - rozmery
  - wymiary
  - rozmiri
  - määrimi
  - dimenzije
  - dimenzije
  - mere
  - razмери
  - išmatavimai
  - izmēri
  - suurused

# IP RATING • IP VÉDELEM • IP-SCHUTZ

Level of protection • Védelem szintje • Schutzgrad		Level of protection • Védelem szintje • Schutzgrad	
SOLIDS • SZILÁRD TÁRGYAK • FREMDKÖRPER		WATER • VÍZ • WASSER	
	0 EN: No protection. HU: Nincs védelem. DE: Nicht geschützt.		0 EN: No protection. HU: Nincs védelem. DE: Nicht geschützt.
	1 EN: Protected against a solid object greater than 50mm, e.g. a hand. HU: 50 mm vagy nagyobb átmérőjű szilárd tárgyak (pl. kézfej) ellen védett. DE: Geschützt gegen feste Fremdkörper größer als 50 mm (z. B. Handrücken)		1 EN: Protected against vertical water drops. HU: Függőleges irányból leeső vízcseppek ellen védett. DE: Geschützt gegen senkrecht fallendes Tropfwasser
	2 EN: Protected against a solid object greater than 12.5mm, e.g. a finger. HU: 12,5 mm vagy annál nagyobb átmérőjű szilárd tárgyak (pl. ujj) ellen védett. DE: Geschützt gegen feste Fremdkörper größer als 12,5 mm (z. B. Finger)		2 EN: Protected against a 15° angle from normal position. HU: Függőleges irányból leeső vízcseppek ellen védett, a lámpa 15 fokos dőlése mellett. DE: Geschützt gegen Tropfwasser bis 15° zur Senkrechten
	3 EN: Protected against a solid object greater than 2.5mm, e.g. a tool. HU: 2,5 mm vagy annál nagyobb átmérőjű szilárd tárgyak (pl. hegyes szerszám) ellen védett. DE: Geschützt gegen feste Fremdkörper größer als 2,5 mm (z. B. spitze Werkzeuge)		3 EN: Protected against water spray at a 60° angle. HU: Vízpermettől védett legfeljebb 60 fokos szög esetén. DE: Geschützt gegen Sprühwasser bis 60° zur Senkrechten
	4 EN: Protected against a solid object greater than 1.0mm, e.g. a wire. HU: 1 mm vagy annál nagyobb átmérőjű szilárd tárgyak (pl. drót) ellen védett. DE: Geschützt gegen feste Fremdkörper größer als 1 mm (z. B. Draht)		4 EN: Protected against water splashing from any angle. HU: Bármely irányból fröccsenő víz ellen védett. DE: Geschützt gegen Spritzwasser aus allen Richtungen
	5 EN: Dust protected. Prevents ingress of dust sufficient to cause damage. HU: Porvédett. Megakadályozza a károsodás okozásához elegendő mennyiségű por behatolását. DE: Staubgeschützt. Geschützt gegen schädliche Staubablagerungen		5 EN: Protected against water jets from any angle. HU: Vízugarak ellen védett minden irányból. DE: Geschützt gegen Strahlwasser aus allen Richtungen
	6 EN: Dust tight. No ingress of dust. HU: Porálló. A burkolat nem engedi át a port. DE: Staubdicht. Vollständig geschützt gegen Berührung und Eindringen von Staub		6 EN: Protected against powerful water jets and heavy seas. HU: Erős vízugar ellen védett. DE: Geschützt gegen starkes Strahlwasser
			7 EN: Water tight against the effect of temporary immersion in water of a depth between 15cm to 1m for up to 30 minutes. HU: Vízbe merítés ellen védett, ha a lámpát ideiglenesen, legfeljebb 30 perc 15 cm és 1 m közötti mélységű vízbe merítik. DE: Geschützt beim Eintauchen bis zu 30 Minuten bei einer Wassertiefe von 15 cm bis zu 1 m
			8 EN: Water tight against long periods of immersion in water (up to 4m). HU: Folyamatos vízbe merítés káros hatásaitól védett (4 m mélységig). DE: Geschützt beim Untertauchen für längere Periode (bis zu 4 m)

**IP 65**

# IK CODE • IK-KÓD • IK-CODE

Degree of protection against external mechanical impacts (W), in Joule:

Külső mechanikai igénybevételekkel szembeni védettség(W), Joule-ban • Schutz gegen äußere mechanische Kräfteinwirkungen (W), in Joule:

IK-Code	IK01	IK02	IK03	IK04	IK05	IK06	IK07	IK08	IK09	IK10
W (J)	0.14	0.2	0.35	0.5	0.7	1	2	5	10	20

# COLOURS • SZÍNEK • FARBEN



alabaster	alabástrom	Alabasterglas	verre albâtre	alabastrové sklo	alabastrové sklo	szkło alabastrowe	алебастрове скло
anthracite	antracit	Anthrazit	anthracite	antracitová	antracit	antracyt	антрацитовий
antique brown	antik barna	Antikbraun	brun antique	antická hnědá	antická hnedá	brąz antyczny	антично коричневий
antique gold	antik arany	Antikgold	or antique	antická zlatá	antická zlatá	złoto antyczne	антично золотий
antique white	antik fehér	Antik Weiß	blanc antique	antikovaná bílá	antická biela	biały antyk	античний білий
black	fekete	Schwarz	noir	černá	čierna	czarny	чорний
blue	kék	Blau	bleu	modrá	modrá	niebieski	синій
brown	barna	Braun	brun	Hnědá	hnedá	Brązowy	коричневий
chrome	króm	Chrome	chrome	chromová	chrómová	chrom	хромовий
gold	arany	Gold	or	zlato	zlato	złoto	золото
green	zöld	Grün	vert	zelená	zelená	zielony	зелений
grey	szürke	Grau	gris	šedá	šedá	popielaty	сірий
grey-beige	szürkésbézs	grau-beige	gris-beige	šedoběžová	šedoběžová	szaro-beżowy	сіро-бежевий
matte black	matt fekete	Mattschwarz	noir mat	matná černá	matná čierna	czarny matowy	матово-чорний
matte white	matt fehér	Mattweiss	blanc mat	matná bílá	matná biela	biały matowy	матово-білий
multicolour	többszínű	Multicolor	multicolore	vícebarevná	viacfarebná	wielokolorowy	багатокольоровий
opal glass	opál üveg	Opalglas	verre opal	opálové sklo	opálové sklo	szkło opalizowane	скло опал
red	piros	Rot	rouge	červená	červená	czerwony	червоний
satin chrome	szatin króm	Satin-Chromfarbig	chrome satiné	hedvábně lesklá chro- mová	saténová chrómová	chrom satyna	сатиново хромовий
silver	ezüst	Silber	argent	stříbrná	strieborná	srebrny	срібний
stainless steel	rozsdamentes acél	Edelstahl	acier inoxydable	nerezová ocel	nehrdzavejúca oceľ	stal nierdzewna	нержавіюча сталь
tinted colour	füst színű	Rauchfarbig	fumée	dýmová barva	dymová	przydymiony	димчастий
transparent	átlátszó	transparent	transparent	průhledná	priehľadná	przezroczysty	прозорий
white	fehér	Weiss	blanc	bílá	biela	biały	білий
wood imitation	fa utáNZat	Holzimitat	imitation bois	imitace dřeva	imitácia dreva	imitacja drewna	імітація дерева

# COLOURS • SZÍNEK • FARBEN



sticlă alabastru	alabastar staklo	alabastar staklo	alabastrno steklo	алабастрово стъкло	rīsu akmens stikls	rīsu akmens stikls	riisikivi klaas
antracit	antracit	antracit	antracitna	антрацитен	antracito pilka	antracīta pelēks	hall antratsiit
maro antic	staro smeđa	staro smeđe	starano rjav	антично кафяв	antikos ruda	antīki brūns	antiik-pruun
auriu antic	staro zlato	staro zlato	staro zlato	антично златен	antikos auksinē	antīks zelts	antiik-kuld
alb antichizat	antik bela	antik bijela	antik bela	антично бяло	antikos balta	antīki balts	antiik-valge
negru	crno	crno	črno	черен	juoda	melns	must
albastru	plavo	plavo	modro	син	mēlyna	zils	sinine
maro	smeđa	braun	rjavo	кафяв	ruda	brūns	pruun
crom	hrom	krom	krom	хром	chrominē	hroms	kroom
aur	zlato	zlato	zlato	злато	auksas	zelts	kuld
verde	zeleno	zeleno	zeleno	зелен	žalia	zaļš	roheline
gri	sivo	sivo	sivo	сив	pilka	pelēks	hall
gri-bej	sivo-bež	sivo-bež	sivo-bež	сиво-бежово	pilka smēlinē	pelēk-bēšs	hallikas-beež
mat negru	mat crno	mat crno	mat črno	мат-черен	matinē juoda	matēti melns	matt must
mat alb	mat belo	mat bijelo	medlobel	мат-бял	matinē balta	matēti balts	matt valge
multicolor	višebojno	višebojno	večbarvno	многоцветен	įvairiaspālvė	daudzkrāsains	mitmevärviline
sticlă opal	opal staklo	opal staklo	opalno steklo	опалово стъкло	opalinio stiklo	opāla stikls	opaaklaas
roșu	crveno	crveno	rdeče	червен	raudona	sarkans	punane
crom satin	satēnasti hrom	satēnasti krom	satēnast krom	сатенен-хром	atlaso chrominē	satīna hroms	satiin-kroom
argintiu	srebrno	srebrno	srebrno	сребърен	sidabrinē	sudraba	hõbe
oțel inoxidabil	nerđajući čelik	nehrđajući čelik	nerjaveče jeklo	неръждаема стомана	nerūdijantis plienas	nerūsējošais tērauds	roostevaba teras
fumuriu	boje dima	indigo plava	barva dima	прозиращо кафяво	su atspalviu	tonēta krāsa	toonitud värv
transparent	providan	proziran	prozorno	прозрачен	skaidri	caurspīdīgs	lābipaistev
alb	belo	bijelo	belo	бял	balta	balts	valge
imitație de lemn	imitacija drveta	imitacija drva	imitacija lesa	ИМИТАЦИЯ НА ДЪРВО	medžio imitacija	koka imitācija	puidu imitatsioon

# KEY OF SYMBOLS • JELMAGYARÁZAT • ZEICHENERKLÄRUNG



GBR



HUN



GER



FRA



CZE



SVK



POL



UKR

	Key of symbols	Jelmagyarázat	Zeichenerklärung	Légende	Legenda	Legenda	Objasnenie znakov	позначення умовних
	item number of spare lampshade	pótbúra cikkszám	Artikelnummer Zusatzschirm	no. d'article du globe supplémentaire	položkové číslo náhradního krytu	číslo položky náhradného tienidla	numer indeksu klosza zapasowego	артикульний номер запасного абажура
	external replacement lampshade item number	külső pótbúra cikkszám	Artikelnummer äußerer Zusatzschirm	numéro d'article globe supplémentaire extérieur	položkové číslo vnějšího náhradního krytu	číslo položky vonkajšieho náhradného tienidla	numer indeksu zewnętrznego klosza zapasowego	артикульний номер зовнішнього запасного абажура
	with light source	fényforrással együtt	mit Leuchtmittel	avec source lumineuse	se světelným zdrojem	spolu so svetelným zdrojom	z źródłem światła	разом з джерелом світла
	without light source	fényforrás nélkül	ohne Leuchtmittel	sans source lumineuse	bez světelného zdroje	bez svetelného zdroja	bez źródła światła	без джерела світла
	with switch	kapcsolóval	mit Schalter	avec commutateur	se spínačem	so spínačom	z wyłącznikiem	із перемикачем
	mounting depth	beépítési mélység	Einbautiefe	profondeur de montage	montážní hloubka	montážna hĺbka	głębokość montażowa	глибина кріплення
	motion sensor	mozgásérzékelő	Bewegungssensor	détecteur mouvement	senzor pohybu	senzor pohybu	czujnik ruchu	датчик руху
	remote controller item number	távírányító cikkszám	Artikelnummer der Fernbedienung	numéro d'article de la télécommande	Číslo položky dálkového ovladače	Číslo položky diaľkového ovládača	Numer produktu pilota	Номер елемента дистанційного керування
	Lumen with shade	Lumen adat burával	Lumen mit Schatten	Lumen avec abat-jour	Lumen se stíněním	Lumen s odtieňom	Lumen z cieniem	Люмен з плафоном
	Lumen without shade	Lumen adat búra nélkül	Lumen ohne Schatten	Lumen sans abat-jour	Lumen bez stínu	Lumen bez tieňa	Światło bez cienia	Люмен без тіні

	Lamp made of	Lámpa anyaga	Lampenmaterial	Le matériel de la lampe	Materiál lampy	Materiál svetidla	Materiał oprawy	Матеріал світильника
	acrylic	akril	acryl	acrylique	akryl	akryl	akryl	акрил
	glass	üveg	glas	verre	sklo	sklo	szkło	скло
	metal	fém	metall	métal	kov	kov	metal	метал
	plastic	műanyag	kunststoff	plastique	plast	umelá hmota	tworzywo sztuczne	пластмаса

	Further key	Egyéb magyarázat	Weitere Erklärungen	Autres explications	jiné vysvětlení	druga razlaga	inne wytłumaczenie	інше пояснення
excl.	excluded	nem tartalmaz	exklusive	excepté	neobsahuje	neobsahuje	nie zawiera	не містить
incl.	included	tartalmaz	inklusive	inclus	obsah	obsahuje	zawiera	містить



ROM



SRB



CRO



SLO



BUL



LTU



LVA



EST

	Legendă	Objasnenje znakov	Tumač znakova	Legenda	Обяснение на условни знаци	Aprašas	Apzīmējumi	Tingmärk
	număr articol abajur suplimentar	oznaka dodatnog abažura	oznaka dodatnog sjenila	koda dodatnega abažura	резервен абажур артикул №	atsarginio gaubto prekės Nr.	maiņas abažūra izstrādājuma Nr.	asenduslambikuppel nr
	număr articol abajur suplimentar pentru exterior	oznaka dodatnog spoljnog abažura	oznaka dodatnog vanjskog sjenila	oznaka dodatnega zunanjega abažura	вншен резервен абажур артикул №	išorinio atsarginio gaubto prekės Nr.	ārējā maiņas abažūra izstrādājuma Nr.	vāline asenduslambikuppel nr
	cu sursă de lumină	zajedno sa izvorom svetlosti	zajedno s izvorom svjetlosti	skupaj z virom svetlobe	включително СВЕТЛИНЕН ИЗТОЧНИК	kartu su šviesos šaltiniu	kopā ar gaismas avotu	koos valgusalikaga
	fără sursă de lumină	bez izvora svetlosti	bez izvora svjetlosti	brez svetlobnega vira	без СВЕТЛИНЕН ИЗТОЧНИК	be šviesos šaltinio	bez gaismas avota	valgusalikata
	cu întrerupător	sa prekidačem	s prekidačem	s stikalom	с превключатель	su jungikliu	ar slēdzi	lūlitiga
	adâncimea de montare	dubina ugradnje	instalacijske ugradnje	globina montaže	дълбочина на монтаж	įmontavimo gylis	iebūvēts dziļums	sisseehitatud sügavus
	senzor de mișcare	senzor kretanja	senzor kretanja	senzor gibanja	със сензор за движение	judesio jutiklis	kustības sensors	liikumisandur
	Număr articol pe telecomandă	Broj stavke daljinskog upravljača	Broj stavke daljinskog upravljača	Številka izdelka daljinskega upravljalnika	Каталожен номер на дистанционното управление	Nuotolinio valdymo pulto prekės numeris	Tālvadības pults vienuma numurs	Puldi artiklinumber
	Lumen cu umbră	Lumen sa senkom	Lumen sa sjenom	Lumen s senco	Люмен със сянка	Lumenas su šešėliu	Lūmenis ar ēnu	Varjuga luumen
	Lumen fără umbră	Lumen bez senke	Lumen bez sjene	Lumen brez sence	Люмен без сянка	Lumenas be šešėlio	Lūmenis bez ēnas	Valendik ilma varjuta

	Materialul lămpi	Materijal svetiljke	Materijal rasvjetnog tijela	Material izdelka	Лампата е произведена от	Šviestuvo medžiaga	Lampas materiāls	Lambi materjal
	acril	akril	akril	akril	акрил	akrilas	akrils	akrüül
	sticlă	staklo	staklo	steklo	стъкло	stiklas	stikls	klaas
	metal	metal	metal	kovinski	метал	metalinė	metāla	metalli
	plastic	plastična	plastika	umetna masa	пластмаса	plastikas	plastmasa	plast

	alte explicații	Druga objašnjenja	Druga objašnjenja	iné vysvetlenie	други обяснения	Kiti simboliai	Citi simboli	Muud sümbolid
excl.	nu conține/ne este inclus	ne sadržava	Ne sadrži	brez (ne vsebuje)	не е включено	neturi	nesatur	ei sisalda
incl.	conține/include	sadržava	sadržava	vsebujejo	включено е	yra su	satur	sisaldab

# KEY OF SYMBOLS • JELMAGYARÁZAT • ZEICHENERKLÄRUNG



	Symbols	Jelölések	Bezeichnungen	Symboles	Jména
	New	Új	Neu	Nouveau	Nový
	Designed by Rabalux	Rábalux saját tervezés	Entworfen von Rabalux	Conçu par Rabalux	Rabalux vlastní design
	Lightsource recommendation	Fényforrás ajánló	Lichtquellenempfehlung	Recommandation de source lumineuse	Doporučený světelný zdroj
	5 years guarantee	5 év garancia	5 Jahre Garantie	5 ans de garantie	Záruka 5 let
	Built-in LED	Beépített LED	LED inklusive	LED inclus	Obsahuje LED
	LED included	LED-et tartalmaz	LED inklusive	LED inclus	Obsahuje LED
	Smart product	Okos termék	Intelligentes Produkt	Produit intelligent	Chytrý produkt
	Wi-Fi	Wi-Fi	Wi-Fi	Wi-Fi	Wi-Fi
	Warm white light	Meleg fehér fényű	Warmweiß	Blanc chaud	Teplá bílá
	Natural white light	Természetes fehér fényű	Naturweiß	Blanc naturel	Přirozená bílá
	Daylight	Napfény	Tageslicht	Lumière du jour	Denní světlo
	Cool white light	Hideg fehér fényű	Kaltweiß	Blanc froid	Studená bílá
	Colour temperature variable with remote control	Távírányítóval állítható színhőmérséklet	Mit fernbedienung einstellbare Farbtemperatur	Température de couleur réglable par télécommande	Nastavení teploty chromatičnosti dálkovým ovladačem
	Adjustable colour temperature	Állítható színhőmérséklet	Einstellbare Farbtemperatur	Température de couleur réglable	Nastavitelná teplota barev
	Color temperature can be adjusted in 3 steps with a switch	Kapcsolóval 3 lépésben szabályozható színhőmérséklet	Die Farbtemperatur kann mit einem Schalter in 3 Stufen eingestellt werden	La température de couleur peut être ajustée en 3 étapes avec un interrupteur	Teplotu barev lze nastavit pomocí přepínače ve 3 krocích
	Color temperature can be adjusted in 3 steps with remote control	Távírányítóval 3 lépésben szabályozható színhőmérséklet	Die Farbtemperatur kann mit einer Fernbedienung in 3 Stufen eingestellt werden	La température de couleur peut être ajustée en 3 étapes avec une télécommande	Barevnou teplotu lze ovládat ve 3 krocích pomocí dálkového ovladače
	Color temperature can be adjusted in three steps with a touch switch	Érintőkapcsolóval három lépésben szabályozható színhőmérséklet	Die Farbtemperatur kann in drei Stufen mit einem Touch-Schalter eingestellt werden	La température de couleur peut être ajustée en trois étapes avec un interrupteur tactile	Teplotu barev lze upravit ve třech krocích dotykovým spínačem
	Color temperature can be adjusted in 3 steps with a CCT switch	CCT kapcsolóval 3 lépésben szabályozható színhőmérséklet	Die Farbtemperatur kann mit einem CCT Schalter in 3 Stufen eingestellt werden	La température de couleur peut être ajustée en 3 étapes avec un interrupteur CCT	Teplotu barev lze nastavit pomocí CCT přepínače ve 3 krocích
	RGB colour change LED	RGB színváltós LED	Farbwechsel-LED	LED à changement de couleurs	LED diody střídající barvu
	Adjustable brightness in 3 steps with switch	Kapcsolóval 3 lépésben szabályozható fényerő	Einstellbare Helligkeit mit Schalter in 3 Stufen	Luminosité ajustable avec interrupteur à 3 positions	Nastavitelný jas pomocí spínače ve 3 krocích

# KEY OF SYMBOLS • JELMAGYARÁZAT • ZEICHENERKLÄRUNG



	Označenia	Oznaczenia	Позначення	Simboluri	Označavanje
	Nový	Nowy	Новий	Nou	Novo
	Rabalux vlastný dizajn	Zaprojektowano przez Rabalux	Розроблений Rabalux	Designed de Rabalux	Rabalux dizajn
	Odporúčanie svetelného zdroja	Rekomendowane źródło światła	Рекомендація щодо джерела світла	Recomandare sursa de lumina	Preporuka za tip sijalice
	Záruka 5 rokov	5-letnia gwarancja	Гарантія 5 років	5 ani garanție	5 godina garancije
	Obsahuje LED diódy	Dioda LED w wyposażeniu	Містить світлодіоди	LED încorporat	Ugrađeni LED
	obsahuje LED diódy	Dioda LED w wyposażeniu	Містить світлодіоди	LED inclus	Sa LED diodom
	Inteligentný produkt	Inteligentny produkt	Розумний продукт	Produs inteligent	Pametnan proizvod
	Wi-Fi	Wi-Fi	Wi-Fi	Wi-Fi	Wi-Fi
	Teplá biela	Ciepła biała	Теплий білий	Alb cald	Toplo bela
	Prírodná biela	Naturalna biała	Натуральний білий	Alb natural	Prirodno bela
	Denné svetlo	Światło dzienne	Денне світло	Lumină naturală	Dnevna svetlost
	Studená biela	Zimna biała	Холодний білий	Alb rece	Hladno bela
	Možnosť nastavenia teploty farieb s diaľkovým ovládačom	Zmienna temperatura barwowa za pomocą pilota	Регулювання колірної температури через пульт дистанційного керування	Temperatura culorii reglabilă de la telecomandă	Sa daljinskim prekidačem može da se podesi temperatura boja
	Nastaviteľná teplota farieb	Można regulować temperaturę barwową	Регульована колірна температура	Temperatura de culoare reglabilă	Podesiva temperatura boje
	Farbnú teplotu je možné nastaviť v 3 krokoch pomocou prepínača	Temperaturę barwową można regulować w 3 krokach za pomocą przełącznika	Колірну температуру можна регулювати в 3 кроки за допомогою перемикача	Temperatura de culoare poate fi reglată în 3 trepte cu un comutator	Temperatura boje se može podesiti u 3 koraka pomoću prekidača
	Farbnú teplotu je možné nastaviť v 3 krokoch pomocou diaľkového ovládača	Temperaturę barwową można regulować w 3 krokach za pomocą pilota	Колірну температуру можна регулювати в 3 кроки за допомогою пульта дистанційного керування	Temperatura de culoare poate fi reglată în 3 trepte cu ajutorul telecomenzii	Temperatura boje se može podesiti u 3 koraka pomoću daljinskog upravljača
	Teplotu farby je možné nastaviť v troch krokoch pomocou dotykového spínača	Temperaturę barwową można regulować w 3 krokach za pomocą przełącznika dotykowego	Колірну температуру можна регулювати в три етапи за допомогою сенсорного перемикача	Temperatura culorii poate fi ajustată în trei pași cu un comutator tactil	Temperatura boje se može podesiti u tri koraka pomoću prekidača na dodir
	Farbnú teplotu je možné nastaviť v 3 krokoch pomocou prepínača CCT	Temperaturę barwową można regulować w 3 krokach za pomocą przełącznika CCT	Колірну температуру можна регулювати в 3 кроки за допомогою CCT-перемикача	Temperatura de culoare poate fi reglată în 3 trepte cu un comutator CCT	Temperatura boje se može podesiti u 3 koraka pomoću CCT prekidača
	LED s meniacou sa farbou	Zmieniający kolor LED	Світлодіоди зі зміною кольору	LED RGB	LED sa promenjivim bojama
	Nastaviteľný jas pomocou spínača v 3 krokoch	Jasność dostosowywana przełącznikiem w 3 krokach	Регульована яскравість з перемикачем в 3 кроки	Luminozitate ajustabilă prin comutator în 3 trepte	Podesivo osvetljenje u 3 koraka uz pomoć prekidača

# KEY OF SYMBOLS • JELMAGYARÁZAT • ZEICHENERKLÄRUNG



CRO



SLO



BUL



LTU



LVA



EST

	Oznake	Oznake	Символи	Simboliai	Simboli	Sümbolid
	Novo	Novo	Ново	Naujas	Jauns	Uus
	Dizajnirao Rablux	Zasnoval Rabalux	Проектирано от Rabalux	Suprojektavo „Rabalux“	Izstrādājis Rabalux	Rabaluxi disain
	Preporuka izvora svjetla	Oporúčanie svetelného zdroja	Препоръка за източник на светлина	Šviesos šaltinio rekomendacija	Ieteikums par gaismas avotu	Valgusallika soovitus
	5 godina jamstva	5 let garancije	5 години гаранция	5 metų garantija	5 gadu garantija	5-aastane garantii
	Ugrađeni LED	Vgrajen LED	Вграден LED	Įmontuotas LED įrenginys	Iebūvēta LED	Sisse-ehitatud LED
	Sadržī LED	Vsebuje LED	С включен LED	LED pridedama	LED iekļauta komplektā	LED on kaasas
	Pametan proizvod	Pameten izdelek	Интелигентен продукт	Protingas produktas	Gudrs produkts	Tark toode
	Wi-Fi	Wi-Fi	Wi-Fi	Wi-Fi	Wi-Fi	Wi-Fi
	Toplo bijelo	Toplo bela	Топло бяло	Šiltai balta	Silti balts	Soe valge
	Prirodno bijelo	Naravno bela	Естествено бяло	Natūraliai balta	Dabīgi balts	Loomulik valge
	Dnevno svjetlo	Dnevna svetloba	Дневна светлина	Dienos šviesa	Dienasgaisma	Päevavalgus
	Hladno bijelo	Hladno bela	Студено бяло	Šaltai balta	Vēsi balts	Külm valge
	Pomoću daljinskog prekidača možete podesiti temperaturu boje	Barvno temperaturo lahko nastavite z daljinskim stikalom	Регулиране на цветната температура с дистанционно управление	Kintanti spalvinė temperatūra su nuotoliniu pulteliu	Maināma krāsu temperatūra ar tālvadības pulti	Muutuv värvustemperatuur kaugjuhtimisega
	Podesiva temperatura boje	Nastavljiva barvna temperatura	Регулируема цветна температура	Reguliuojama temperatūra	Regulējama krāsu temperatūra	Reguleeritav värvustemperatuur
	Temperatura boje može se podesiti u 3 koraka pomoću prekidača	Barvno temperaturo lahko nastavite v 3 korakih s stikalom	Цветовата температура може да се регулира на 3 стъпки с превключвател	Spalvos temperatūrą galima reguliuoti 3 žingsniais jungikliu	Krāsu temperatūru var regulēt 3 soļos ar slēdzi	Värvitemperatuuri saab lülitiga reguleerida 3 astmes
	Temperatura boje može se podesiti u 3 koraka daljinskim upravljačem	Barvno temperaturo lahko nastavite v 3 korakih z daljinskim upravljalnikom	Цветовата температура може да се регулира в 3 стъпки с дистанционното управление	Spalvos temperatūrą nuotolinio valdymo pulteliu galima reguliuoti 3 žingsniais	Krāsu temperatūru var regulēt 3 soļos ar tālvadības pulti	Värvitemperatuuri saab puuteliitiga kolmes astmes reguleerida
	Temperatura boje može se podesiti u 3 koraka pomoću prekidača na dodir	Barvno temperaturo lahko nastavite v 3 korakih s stikalom na dotik	Цветовата температура може да се регулира на три стъпки с сензорен превключвател	Spalvos temperatūrą galima reguliuoti trimis žingsniais jutikliniu jungikliu	Krāsu temperatūru var regulēt trīs soļos ar skārienslēdzi	Värvitemperatuuri saab puuteliitiga kolmes astmes reguleerida
	Temperatura boje može se podesiti u 3 koraka pomoću CCT prekidača	Barvno temperaturo lahko nastavite v 3 korakih s CCT stikalom	Цветовата температура може да се регулира на 3 стъпки с CCT превключвател	Spalvos temperatūrą galima reguliuoti 3 žingsniais CCT jungikliu	Krāsu temperatūru var regulēt 3 soļos ar CCT slēdzi	Värvitemperatuuri saab CCT-lülitiga reguleerida 3 astmes
	LED s promjenjivim bojama	LED diode s spremenljivim barvama	LED с променлива светлина	Spalvą keičiantis LED	Maināmas krāsas LED	Värvi vahetav LED
	Prilagodljiva svjetlina s prekidačem u tri koraka	Prilagodljiva svetlost s stikalom v 3 korakih	Регулируема яркост с ключ на 3 степени	Ryškusmas reguliuojamas su jungikliu 3 žingsniais	Trīs līmeņu regulējams spilgtums ar slēdzi	Lülitist 3-astmeliselt reguleeritav heledus

# KEY OF SYMBOLS • JELMAGYARÁZAT • ZEICHENERKLÄRUNG



GBR



HUN



GER



FRA



CZE



SVK

	Symbols	Jelölések	Bezeichnungen	Symboles	Jména	Označenia
	Adjustable brightness in 3 steps with touch switch	Érintőkapcsolóval több lépésben szabályozható fényerő	Einstellbare Helligkeit mit Touch-Schalter in 3 Stufen	Luminosité ajustable avec interrupteur tactile à 3 positions	Nastavitelný jas s dotykovým spínačem ve 3 krocích	Nastavitelný jas s dotykovým spínačom v 3 krokoch
	With switch	Kapcsolóval	Mit Schalter	Avec commutateur	Se spínačem	So spínačom
	Remote control	Távírányítóval	Fernbedienung	Télécommande	Dálkové ovládání	Diaľkový ovládač
	Brightness adjustable with a switch	Kapcsolóval állítható fényerő	Helligkeit per Schalter einstellbar	Luminosité réglable via interrupteur	Nastavitelná intenzita světla pomocí spínače	Nastavitelná intenzita svetla pomocou vypínača
	Brightness adjustable by remote control	Távírányítóval állítható fényerő	Helligkeit per Fernbedienung einstellbar	Luminosité réglable par télécommande	Nastavitelná intenzita světla dálkovým ovládačem	Nastavitelná intenzita svetla diaľkovým ovládačom
	Touch switch dimmer	Érintőkapcsolóval szabályozható fényerő	Touchbutton-Lichtstärkeregler	Réglage de la luminosité avec interrupteur tactile	Nastavení jasu dotykovým spínačem	Dotykový spínač na regulácia intenzity svetla
	Dimmable	Szabályozható fényerő	Lichtstärke Regler	Regleur d'intensité de la lumière	Regulátor jasu	Regulátor jasu
	Motion sensor	Mozgásérzékelő	Bewegungssensor	Détecteur mouvement	Senzor pohybu	Senzor pohybu
	Microwave sensor	Mikrohullámú mozgásérzékelő	Mikrowellen-Sensor	Capteur à micro-ondes	Mikrovlnný snímač	Mikrovlnný snímač
	Illuminates upwards	Felfelé világít	Leuchtet nach oben	Éclaire vers le haut	Svítlí nahoru	Svietí nahor
	Illuminates downwards	Lefelé világít	Leuchtet nach unten	Éclaire vers le bas	Směr svícení dolů	Svieti smerom dole
	Illuminates downwards and upwards	Lefelé és felfelé is világít	Leuchtet nach oben und nach unten	Éclaire vers le bas et vers le haut	Směr svícení nahoru i dolů	Svieti smerom dole aj hore
	Environmentally friendly	Környezetbarát	Umweltschonend	Écologique	Je šetrný k životnímu prostředí	Šetrný k životnému prostrediu
	Light reactive, only illuminates in the dark	Fényérzékelő lámpa, csak sötétben világít	Mit Helligkeitssensor, leuchtet nur im Dunkeln	L'appareil est muni d'un photodétecteur, il ne se manifestera que s'il est plongé dans l'obscurité	Se světelným senzorem, svítí pouze ve tmě	So svetelným senzorem, svietí iba v tme
	UV resistant plastic	UV álló műanyag	UV-beständiger Kunststoff	Plastique résistant à l'UV	Plast odolný UV záření	Plast odolný UV žiareniu
	Lamp operating with solar cells	Napelemmel működő lámpa	Leuchte funktioniert über Solarzellen	Luminaire fonctionnant avec une cellule photovoltaïque	Svítidlo na solární baterii	Plast odolný UV
	IP protection	IP védettség	IP-Klasse	Protection IP	IP krytí	IP ochrana
	Indirect light	Indirekt fény	Mit indirektem Licht	À lumière indirecte	S nepřímým světlem	S nepriamym svetlom
	Backlight effect	Háttérfény funkció	Hintergrundlichteffekt	Effet de contre-jour	Efekt podsvícení	Efekt podsvietenia
	Adjustable sensor	Állítható érzékelő	Verstellbarer sensor	Capteur réglable	Nastavitelný senzor	Nastavitelný senzor

# KEY OF SYMBOLS • JELMAGYARÁZAT • ZEICHENERKLÄRUNG



	Oznaczenia	Позначення	Simboluri	Označavanje	Oznake
	Jasność dostosowywana dotykowo w 3 krokach	Регульована яскравість з сенсорним перемикачем в 3 кроки	Luminozitate ajustabilă prin atingere, în 3 trepte	Podesivo osvetljenje u 3 koraka uz pomoć prekidača koji se aktivira dodirom	Prilagodljiva svjetlina s dodirnim prekidačem u tri koraka
	Z włącznikiem	Із перемикачем	Cu întrerupător	Sa prekidačem	S prekidačem
	Pilot zdalnego sterowania	Дистанційне керування	Telecomandă	Dalečinski upravljač	Daljinski upravljač
	Regulacja jasności za pomocą przełącznika	Регулювання яскравості за допомогою вимикача	Intensitate luminoasă reglabilă cu ajutorul întrerupătorului	Podešavanje jačine svetla prekidačem	Podešavanje jačine svjetla prekidačem
	Regulacja jasności za pomocą pilota	Регулювання яскравості за допомогою пульта дистанційного керування	Intensitate luminoasă reglabilă cu telecomandă	Podešavanje jačine svetla daljinskim upravljačem	Podešavanje jačine svjetla daljinskim upravljačem
	Ściemniacz dotykowy	Сенсорний диммер	Senzor tactil pentru reglarea luminozității	Podešavanje jačine svetlosti sa prekidačem na dodir	Podešavanje svjetline pomoću dodirne sklopke
	Regulator natężenia światła	Регулятор потужності світла	Regulator intensitate lumina	Regulator svetlosti	Regulator jačie svjetla
	Czujnik ruchu	Датчик руху	Senzor de mișcare	Senzor kretanja	Senzor kretanja
	Mikrofalowy czujnik ruchu	Мікрохвильовий датчик	Senzor cu microunde	Mikrotalasni senzor	Mikrovalni senzor
	Świeci do góry	Світиться вгору	Iluminează în sus	Svetli prema gore	Osvjetljava prema gore
	Świeci w dół	Напря́м світла донизу	Luminează în jos	Nadole svetli	Svijetli nadolje
	Świeci w dół i w górę	Напря́м світла донизу і догори	Luminează în jos și în sus	Svetli i nagore i nadole	Svijetli i nadolje i nagore
	Przyjazny dla środowiska	Безпечний для довкілля	Ecologic	Ekološki prihvatljiv	Ekološki prihvatljiv
	Z czujnikiem oświetlenia, świeci tylko w ciemności	Оснащений сутінковим світловим вмикачем, включається тільки при зниженні інтенсивності освітлення	Cu sensor, luminează doar în întuneric	Osetljiv na svetlost, svetli samo u mraku	Osjetljiv na svjetlost, svijetli samo u mraku
	Tworzywo sztuczne odporne na UV	УФ-стійкий пластик	Material plastic rezistent la UV	UV otporna plastika	Plastika otporna na UV zrake
	Lampa zasilana energią słoneczną	Лампа на сонячній батареї	Lampă cu acumulator solar	Solarna lampa	Solarna svjetiljka
	Stopień ochrony IP	Клас IP-захисту	Protecția IP	IP zaštita	IP zaštita
	Ze światłem pośrednim	З непрямим освітленням	Cu lumină indirectă	Sa indirektnim svetlom	S neizravnim svjetlom
	Efekt podświetlenia	Ефект підсвічування	Efect iluminare de fundal	Pozadinsko osvetljenje	Efekt pozadinskog svjetla
	Regulowany czujnik	Регульований датчик	Senzor reglabil	Podesivi senzor	Podesivi senzor

# KEY OF SYMBOLS • JELMAGYARÁZAT • ZEICHENERKLÄRUNG



new/új/neu	Oznake	Символи	Simboliai	Simboli	Sümbolid
	Prilagodljiva svetlost s stikalom na dotik v 3 korakih	Регулируема яркост с ключ с докосване на 3 степени	Ryškumas reguliuojamas su jutkliniu jungikliu 3 žingsniais	Trīs līmeņu regulējams spilgtums ar skārienjūtīgu slēdzi	Puutelülitist 3-astmeliselt reguleeritav heledus
	S stikalom	С превключвател	Su jungikliu	Ar slēdzi	Lūlitiga
	Daljinski upravljalnik	Дистанционно управление	Nuotolinio valdymo pultas	Tālvadības pults	Pult kaugjuhtimiseks
	Nastavljiva svetlost s stikalom	Регулиране на яркостта с превключвател	Ryškumas reguliuojamas jungikliu	Spilgtums regulējams ar slēdzi	Heledus reguleeritav lūlitiga
	Nastavljiva svetlost z daljinskim upravljalnikom	Регулиране на яркостта с дистанционно управление	Ryškumas reguliuojamas nuotolinio valdymo pultu	Spilgtums regulējams ar tālvadības pulti	Heledus reguleeritav puldīga
	Prilagodite svetlost z stikalom na dotik	Регулятор на яркостта със сензорен превключвател	Liečiamasis pritemdymo jutiklis	Skārienjutīgs gaismaiņa slēdzis	Puutetundlik valgusregulaator
	Zatemnilnik	С регулятор за силата на светлина	Pritemdymo įtaisas	Gaismmainis	Hāmardi
	Senzor gibanja	Със сензор за движение	Judesio jutiklis	Kustības sensors	Liikumisandur
	Mikrovalovni senzor	Микровълнов сензор	Mikrobangų jutiklis	Mikrovļņu sensors	Mikrolaineandur
	Sveti navzgor	Свети нагоре	Šviesa nukreipta į viršų	Iedegas uz augšu	Valgustab ülespoole
	Svetli navzdol	Осветява надолу	Šviečia žemyn	Apgaismo lejup	Valgustab allapoole
	Svetel in gor in dol	Осветява надолу и нагоре	Šviečia žemyn ir aukštyn	Apgaismo lejup un augšup	Valgustab alla- ja ülespoole
	Okolju prijazno	Щадящ околната среда	Draugiškas aplinkai	Videi draudzīgs	Keskkonnasõbralik
	Občutljivo na svetlobo, sveti le v temi	Реагира на светлина, светва само, когато е тъмно	Reaguoja į šviesą, užsidega tik tamsoje	Reaģējošs uz gaismu, apgaismo tikai tumsā	Valgusreaktiivne, valgustab vaid pimedas
	Plastika UV-odporen	Устойчива на UV лъчи пластмаса	UV atsparus plastikas	Pret UV stariem noturīga plastmasa	UV-kindel plastik
	Sončna svetilka	Лампа, работеща със слънчеви батерии	Veikia su saulės energijos skydeliu	Darbojas ar saules bateriju	Sisselūlitamine pāikeseselemendīga
	IP zaščita	с IP защита	IP klasė	IP aizsardzība	IP kaitse
	S posredno svetlobo	С индиректна светлина	Su netiesiogine šviesa	Ar netiešu gaismu	Kaudvalgusega
	Učinek osvetlitve	Ефект на подсветка	Foninio apšvietimo efektas	Aizmugurapgaismojuma efekts	Tagantvalgustuse efekt
	Nastavljiv senzor	Регулируем сензор	Reguliuojamas jutiklis	Regulējams sensors	Reguleeritav andur

# KEY OF SYMBOLS • JELMAGYARÁZAT • ZEICHENERKLÄRUNG



new/új/neu	Symbols	Jelölések	Bezeichnungen	Symboles	Jména
	Moveable heads	Mozgatható fej	Bewegliche Köpfe	Têtes mobiles	Pohyblivé hlavy
	Infrared remote	Infravörös távirányító	Infrarotfernbedienung	Télécommande infrarouge	Infračervené dálkové ovládání
	Plastic	Műanyag	Plastik (Kunststoff)	Plastique	Plast
	Timer function	Időzítő funkció	Mit einer Zeitfunktion	Avec fonction de temps	S časovačem
	Night light function	Éjszakai funkció	Nachtfunktion	Fonction nuit	Funkce nočního světla
	Memory function	Memória funkció	Speicherfunktion	Fonction mémoire	Funkce pamět
	Can be controlled via Bluetooth	Vezérlés Bluetooth kapcsolaton keresztül	Steuerung über Bluetooth	Commande via liaison Bluetooth	Ovládání prostřednictvím Bluetooth kontaktu
	Micro-USB included	Micro-USB tartozék	Micro-USB Zubehör	Avec Micro USB livré	Micro-USB v příslušenství
	Battery excluded	Elemet nem tartalmaz	Ohne Batterie	Pile non incluse	Baterie není součástí balení
	Battery included	Elemet tartalmaz	Inklusive Batterie	Pile incluse	Součástí balení je baterie
	IK08 strong diffusor	Búra mechanikus ütődés elleni védelem 08	Schlagfestigkeit IK08	Diffuseur puissant IK08	Odolnost proti nárazu IK08
	Equipped with SCHUKO Type F, CEE 7/4 power connector socket. Not available for CZ, SK and PL.	SCHUKO Type F, CEE 7/4 hálózati csatlakozó aljzattal. Nem rendelhető: CZ, SK és PL.	Mit SCHUKO Netzstecker Typ F, CEE 7/4. Nicht bestellbar in: CZ, SK und PL	SCHUKO Type F, avec douille CEE 7/4. Ne peut être commandé : CZ, SK et PL	SCHUKO Type F, CEE 7/4 se síťovou zásuvkou. Nelze objednat: CZ, SK a PL
	Cutttable	Vágható	Schneidbar	Découpable	Řezatelný
	Not suitable for cutting	Nem vágható	Nicht zerschneidbar	Ne peut pas être coupé	Nelze stříhat
	Number of LED diodes per metre	LED diódák száma méterenként	Anzahl der LED-Dioden pro Meter	Nombre de diodes DEL par mètre	Počet LED diod na metr
	2 in 1	Kettő az egyben	2 in 1	2 en 1	2 v 1
	Delivery unit	Szállítási egység	Liefereinheit	Unité de transport	Dodací jednotka
	Units/set	Darab/szett	Stück/set	Pièce / lot	Ks/sada

# KEY OF SYMBOLS • JELMAGYARÁZAT • ZEICHENERKLÄRUNG



new/új/neu	Označenia	Oznaczenia	Позначення	Simboluri	Označavanje
	Pohyblivé hlavy	Ruchome głowy	Рухомі голови	Capete mobile	Покретне главе
	Infračervené diaľkové ovládanie	Pilot na podczerwień	Інфрачервоний пульт	Telecomandă cu infraroșu	Infracrveni daljinski
	Plast	Wykonane z plastiku	Пластик	Plastic	Plastika
	S časovačom	Z funkcją timera	З функцією таймера	Cu temporizator	Sa vremenskom funkcijom
	Funkcia nočného svetla	Funkcja światła nocnego	Функція нічника	Funcție lumina de noapte	Funkcija nočno svetlo
	Funkcia pamäte	Funkcja pamięci	Функція пам'яті	Funcție de memorie	Funkcija pamćenja
	Riadenie prostredníctvom Bluetooth pripojenia	Sterowanie przez połączenie Bluetooth	Керування через Bluetooth	Operare prin conexiune Bluetooth	Upravljanje preko Bluetooth veze
	Príslušenstvo Micro-USB	Micro-USB w zestawie	Містить мікро-USB	Accesoriu Micro-USB	Mikro-USB dodatna oprema
	Batéria nie je súčasťou balenia	Nie zawiera baterii	Батарея не додається	Bateria nu e inclusă	Bez baterije
	Súčasťou balenia je batéria	Bateria w zestawie	Батарея додається	Bateria este inclusă	Baterija u opremi
	Silný difúzor IK08	Ochrona przed uderzeniami mechanicznymi IK08	Захист від механічного пошкодження плафону IK08	Difuzor puternic IK08	IK08 čvrst difuzor
	SCHUKO Type F, CEE 7/4 so sieťovou zásuvkou. Nie je možné objednať: CZ, SK a PL	Z gniazdem zasilania SCHUKO Type F, CEE 7/4. Brak możliwości zamawiania: CZ, SK i PL	SCHUKO Type F, з гніздом живлення CEE 7/4. Неможливо замовляти: CZ, SK та PL	Cu soclu priză SCHUKO Type F, CEE 7/4. Nu poate fi comandat în CZ, SK și PL	Sa mrežnom priključnicom tipa SCHUKO Type F, CEE 7/4. Ne može da se naruči iz: CZ, SK i PL
	Strihateľný X cm	Do cięcia	Обрізний	Tăiat	Reziv
	Nemožno strihať	Cięcie nie jest możliwe	Не можна різати	Nu poate fi tăiat	Ne može se seći
	Počet LED diód na meter	Liczba diod LED na metr	Кількість світлодіодів на метр	Nr. de LED-uri pe metru	Broj LED dioda po metru
	3 v 1	2 w 1	2 в 1	2 în 1	2 u 1
	Dodacia jednotka	Jednostka logistyczna	Одиниця поставки	Unitate de livrare	Transportna jedinica
	Kus/sada	Sztuka/zestaw	Шт / комплект	Bucăți/set	Komad/set

# KEY OF SYMBOLS • JELMAGYARÁZAT • ZEICHENERKLÄRUNG



new/új/neu	Oznake	Oznake	Символи	Simboliai	Simboli	Sümbolid
	Pokretni glave	Premične glave	Подвижни глави	Judamosios galvos	Pārvietojamas galvas	Liikuvad pead
	Infracrveni daljinski upravljač	Infrardeči daljinski upravljalnik	Инфрачервено дистанционно	Infraraudonųjų spindulių nuotolinio valdymo pultas	Infrasarkano staru tālvadības pults	Infrapuna kaugjuhtimispult
	Plastika	Plastika	Пластмаса	Plastikinis	Plastmasa	Plastist
	S vremenskom funkcijom	S časovno funkcijo	С функция за време	Su laiko funkcija	Ar laika funkciju	Ajafunktsiooniga
	Funkcija nočnog svjetla	Nočna funkcija	Функция ношна светлина	Naktinio apšvietimo funkcija	Nakts apgaismojuma funkcija	Õine funktsioon
	Funkcija memorije	Pomnilna funkcija	Функция памет	Atminties funkcija	Atmiņas funkcija	Mālu funktsioon
	Upravljanje putem Bluetootha	Nadzor prek povezave Bluetooth	Управление чрез Bluetooth връзка	Galima valdyti naudojant Bluetooth	Var kontrolēt, izmantojot Bluetooth	Juhitav Bluetooth kaudu
	Mikro USB pribor	Mikro USB-pripomoček	С принадлежност Micro-USB	Priedama „Micro-USB“	Micro-USB iekļauts komplektā	Mikro-USB komplektis
	Baterija nije uključena	Baterije niso vključene	Не е предоставена батерия	Be baterijos	Baterija neietilpst komplektā	Patarei ei kuulu komplekti
	Baterija je uključena	Baterije so vključene	Предоставена батерия	Su baterija	Baterija ietilpst komplektā	Patarei kuulub komplekti
	Zaštita od mehaničkih utjecaja	IK08 močan difuzor	Устойчивост на удар IK08	Tvirtumo klasė IK08	IK08 spēcīgs difuzors	IK08 löögikindluse klassi hajuti
	S mrežnim priključkom tipa SCHUKO Type F, CEE 7/4 Nije moguće naručiti iz: CZ, SK i PL	Z vtičem tipa SCHUKO Type F, CEE 7/4 Ni mogoče naročiti pri: CZ, SK in PL	SCHUKO Type F, захранващо щепселно гнездо CEE 7/4. Не може да се заявява за: CZ, SK и PL	Įmontuotas SCHUKO F tipo CEE 7/4 maitinimo įvesties liždas. Neprieinama CZ, SK ir PL	Aprīkots ar SCHUKO F tipa, CEE 7/4 strāvas ievades/izvades ligzdu. Nav pieejams CZ, SK un PL	SCHUKO Tüüp F, CEE 7/4 toite sisse/välja pistikuga. Mitte saadaval CZ, SK ja PL jaoks
	Režeći	Rezljiv	Режещ	Pjaustomas	Lõigatav	Lõigatud
	Ne može se rezati	Ni mogoče rezati	Не може да се реже	Netinka pjaustymui	Nav piemērots griešanai	Ei sobi lõikamiseks
	Broj LED dioda po metru	Število LED dioda na meter	Брой светодиоди на метър	Šviesos diodų skaičius viename metre	Diožu skaits uz metru	Valgusdiodide arv meetri kohta
	2 u 1	2 v 1	2 в 1	Du viename	Divi vienā	Kaks-ühes
	Transportna jedinica	Transportna enota	Транспортна единица	Pristatomas įrenginys	Piegādes vienība	Tarnesse kuulub
	Komad / set	Kos / set	Брой/сет	Vnt./Rinkinys	Gab./Komplektā	Tükki/komplekt

# CONTENTS • TARTALOMJEGYZÉK • INHALTSVERZEICHNIS

New	Art. number	Name	Page
Új	Cikkszám	Név	Oldal
Neu	Art. number	Name	Seite

	2697	ZENON	115
	2698	ZENON	115
	3309	YAGO	143
	3437	LUCAS	114
<b>new</b>	71504	LUCAS 2	114
	3438	LUCAS	114
<b>new</b>	71505	LUCAS 2	114
	3439	LUCAS	114
<b>new</b>	71506	LUCAS 2	114
<b>new</b>	71510	LUCAS 2	114
<b>new</b>	71511	LUCAS 2	114
<b>new</b>	71512	LUCAS 2	114
	5810	LENTIL	125
	7040	ODERA	153
	7060	TURDA	167
	7070	ZATON	91
	7127	TAVERNA	46
	7128	TAVERNA	46
	7129	TAVERNA	46
	7130	TAVERNA	46
	7146	PARAVENTO	45
	7147	PARAVENTO	45
	7149	PARAVENTO	45
	7150	PARAVENTO	45
	7158	TEPLICE	41
	7159	TEPLICE	41
	7236	NOVIGRAD	90
	7237	NOVIGRAD	90
	7238	DUBROVNIK	47
	7239	DUBROVNIK	47
	7240	DUBROVNIK	47
	7244	ORLOVA	93
	7250	PERNIK	103
	7265	PERNIK	103
	7317	LIPPA	69
	7318	LIPPA	69
	7319	LIPPA	69
	7320	LIPPA	69
	7379	ANKARA	39
	7380	ANKARA	39
	7386	KOLTA	89
	7396	SOLIN	68
	7397	SOLIN	68
	7406	HORT	125
	7407	HORT	125
	7408	HORT	125
	7409	HORT	125
	7476	BALIMO	77
	7477	BALIMO	77
	7478	BALIMO	77
	7479	BALIMO	77
	7502	WELLINGTON	89
	7504	PALANGA	32
	7505	PALANGA	32
	7506	PALANGA	32
	7774	INVERNESS	101
	7775	INVERNESS	101
	7797	OPOLE	74
	7814	KROBIA	167
	7817	ZOMBOR	94
	7818	ZOMBOR	94
	7819	ZOMBOR	94
	7820	ZOMBOR	94
	7826	LISBON	52
	7827	LISBON	52
	7828	LISBON	52
	7829	LISBON	52
	7836	MADRID	140

New	Art. number	Name	Page
Új	Cikkszám	Név	Oldal
Neu	Art. number	Name	Seite

	7837	MILANO	134
	7850	YOLA	164
	7877	FUNGHETTO	168
	7880	OSTRAVA	159
	7881	OSTRAVA	159
	7884	ALMADA	44
	7885	ALMADA	44
	7887	BUFFALO	85
	7888	BUFFALO	85
	7891	SILISTRA	90
	7892	SILISTRA	90
	7893	TARTU	104
	7894	TARTU	104
	7895	TARTU	104
	7896	TARTU	104
	7897	TARTU	104
	7898	TARTU	104
	7899	TARTU	104
	7900	TARTU	104
	7904	BELFAST	37
	7929	ELVA	37
	7930	ELVA	37
	7935	HALDEN	80
	7951	NESNA	72
	7952	NESNA	72
	7955	SINTRA	85
	7956	SINTRA	85
	7959	MANDAL	88
	7960	MANDAL	88
	7969	AMARILLO	126
	7970	OPAVA	159
	7975	DANNET	165
	7979	ERIC	115
	7980	AMARILLO	126
	8011	PUEBLO	127
	8018	CHILE	87
	8019	CHILE	87
	8029	CHILE	87
	8030	CHILE	87
	8118	PHOENIX	88
	8119	PHOENIX	88
	8130	NAVIA	63
	8134	VARNA	80
	8135	VARNA	80
	8145	BLACKTORCH	48
	8146	BLACKTORCH	48
	8147	BLACKTORCH	48
	8148	BLACKTORCH	48
	8149	AKRON	95
	8150	AKRON	95
	8154	FOLLINA	63
	8163	ODESSA	139
	8164	ODESSA	139
	8165	ODESSA	139
	8181	MONACO	130
	8182	MONACO	130
	8184	MONACO	130
	8185	MONACO	130
	8186	MONACO	130
	8190	DARIUS	146
	8201	VELENCE	136
	8202	VELENCE	136
	8203	VELENCE	136
	8204	VELENCE	135
	8205	VELENCE	136
	8206	VELENCE	135
	8207	VELENCE	136
	8208	VELENCE	135

New	Art. number	Name	Page
Új	Cikkszám	Név	Oldal
Neu	Art. number	Name	Seite

	8209	VELENCE	136
	8210	VELENCE	135
	8216	VELENCE	136
	8217	VELENCE	135
	8218	VELENCE	137
	8232	VELENCE	137
	8234	VELENCE	137
	8236	VELENCE	137
	8238	VELENCE	137
	8240	VELENCE	137
	8244	HAGA	147
	8261	INOXTORCH	50
	8263	INOXTORCH	50
	8264	INOXTORCH	50
	8265	INOXTORCH	51
	8266	INOXTORCH	51
	8267	INOXTORCH	51
	8270	OSLO	143
	8271	OSLO	142
	8337	BONN	49
	8338	BONN	49
	8339	BONN	49
	8341	MILANO	134
	8342	MILANO	134
	8344	MILANO	134
	8345	MILANO	134
	8346	MILANO	134
	8365	SOLAR1	169
	8366	SOLAR1	169
	8370	MILANO	132
	8371	MILANO	132
	8372	MILANO	132
	8373	MILANO	133
	8374	MILANO	133
	8375	MILANO	133
	8376	MILANO	132
	8377	MADRID	140
	8379	MADRID	141
	8381	TORONTO	131
	8391	TOSCANA	138
	8392	TOSCANA	138
	8394	TOSCANA	138
	8395	TOSCANA	138
	8409	ROMA	92
	8410	ROMA	92
	8460	TORONTO	131
	8476	MADRID	140
	8480	MADRID	141
	8496	HEKTOR	146
	8499	HEKTOR	146
	8511	ROMA	92
	8680	OSLO	144
	8681	OSLO	142
	8682	OSLO	144
	8683	STUTTGART	117
	8684	STUTTGART	117
	8685	STUTTGART	117
	8686	VIGO	145
	8687	VIGO	145
	8714	TACOMA	127
	8716	OSLO	144
	8717	OSLO	144
	8736	OSLO	142
	8737	OSLO	142
	8739	OSLO	142
	8740	OSLO	142
	8753	NORVICH	147

New	Art. number	Name	Page
Új	Cikkszám	Név	Oldal
Neu	Art. number	Name	Seite

	8754	NORVICH	147
	8763	OSLO	143
	8764	OSLO	143
	8766	DURANGO	93
	8767	DURANGO	93
	8776	ROMA	92
	8795	BIRMINGHAM	75
	8799	SEVILLA	93
	8800	SEVILLA	93
	8832	MEDINA	86
	8833	MEDINA	86
	8834	MEDINA	86
	8835	MEDINA	86
	8873	MARIBOR	70
	8874	MARIBOR	70
	8888	BUDAPEST	43
	8889	BUDAPEST	43
	8890	BUDAPEST	43
	8893	TRENTO	126
	8894	TRENTO	126
	8940	RODEZ	75
	8948	MORA	166
	8949	MORA	166
	71132	LUCAS	121
	71133	LUCAS	121
	71134	LUCAS	121
	71252	SAMIRA	110
	71253	SAMIRA	110
	71254	SAMIRA	110
	71255	SAMIRA	111
	71256	SAMIRA	111
	71257	SAMIRA	110
	71258	SAMIRA	110
	71259	SAMIRA	110
	71260	SAMIRA	111
	71261	SAMIRA	111
	71342	KOVEN	95
	71343	KOVEN	95
	71422	ALENZO	107
	71423	ALENZO	107
	71424	ALENZO	108
	71425	ALENZO	106
	71426	ALENZO	106
	71427	ALENZO	106
	71428	ALENZO	108
	71429	ALENZO	106
	71430	ALENZO	108
	71431	ALENZO	101
	71432	ALENZO	107
	71433	ALENZO	107
	71434	ALENZO	108
	71435	ALENZO	106
	71436	ALENZO	106
	71437	ALENZO	106
	71438	ALENZO	108
	71439	ALENZO	106
	71440	ALENZO	108
	71441	ALENZO	101
	75009	LARCIA	116
	75010	LARCIA	116
	75011	LARCIA	121
	75012	LARCIA	121
	75025	GAELO	115
	75026	GAELO	115
<b>new</b>	75065	Dolen	97
<b>new</b>	75066	Dolen	97
<b>new</b>	75067	Dolen	96
<b>new</b>	75068	Dolen	96

New	Art. number	Name	Page
Új	Cikkszám	Név	Oldal
Neu	Art. number	Name	Seite

<b>new</b>	75069	Modane	56
<b>new</b>	75070	Modane	56
<b>new</b>	75071	Shaun Plus	118
<b>new</b>	75072	Shaun Plus	118
<b>new</b>	75073	Shaun Plus	118
<b>new</b>	75074	Shaun Plus	118
<b>new</b>	75075	Shaun Plus	118
<b>new</b>	75076	Shaun Plus	118
<b>new</b>	75077	Shaun Plus	118
<b>new</b>	75078	Shaun Plus	118
<b>new</b>	75079	Shaun Plus	118
<b>new</b>	75080	Maurec	98
<b>new</b>	75081	Maurec	98
<b>new</b>	75082	Maurec	98
<b>new</b>	75083	Lautrec	99
<b>new</b>	75084	Lautrec	99
<b>new</b>	75085	Lautrec	99
	76036	MIREO	151
	76037	MIREO	151
	76038	MIREO	151
	76039	MIREO	151
	77001	WIGRY	171
	77002	BOBUS	171
	77004	NARMADA	156
	77005	QESA	156
	77006	BREZNO	157
	77011	KELNA	167
	77012	ZLARIN	163
	77013	SEPIK	157
	77014	MOSELLE	156
	77015	KAPUAS	157
	77016	ANSOO	172
	77017	ALASKA	155
	77018	ALASKA	155
	77019	VALPOVO	163
	77020	LIHULL	162
	77024	KANGTON	156
	77025	ANKARA	39
	77026	ANKARA	39
	77028	HITURA	124
	77029	HITURA	124
	77030	LUTTO	157
	77035	INDRE	102
	77036	INDRE	102
	77040	FLAXTON	161
	77042	RENNES	75
<b>new</b>	77043	Tavira	170
	77046	SLUIS	164
	77049	TILBURG	62
	77050	TILBURG	62
<b>new</b>	77052	Zilina	59
<b>new</b>	77053	Zilina	59
	77054	CERNON	29
	77055	CERNON	29
	77056	CERNON	29
	77057	ODIEL	30
	77058	ODIEL	30
	77059	ODIEL	30
	77060	ODIEL	30
<b>new</b>	77063	Kioni	60
	77064	SENICA	81
	77065	TEMSE	63

# CONTENTS • TARTALOMJEGYZÉK • INHALTSVERZEICHNIS

New	Art. number	Name	Page
Új	Cikkszám	Név	Oldal
Neu	Art. number	Name	Seite

	77074	MATARO	71
	77075	MATARO	71
	77076	MATARO	71
<b>new</b>	77077	Pemba	61
	77078	LASSET	155
	77079	LASSET	155
	77080	LOANDA	40
	77081	LOANDA	40
	77082	LOANDA	40
	77085	ZERNEST	91
	77086	ZERNEST	91
	77088	NANTES	167
	77090	FLAXTON	161
	77092	ZARAGOZA	78
	77093	ZARAGOZA	78
	77095	ANDELLE	76
	77096	ANDELLE	76
	77097	GIMONE	76
	77098	GIMONE	76
	77099	LUBLIN	74
	77100	LUBLIN	74
	77101	TELDE	28
	77102	TELDE	28
	77103	MEDNA	28
	77104	MEDNA	28
	77105	TRENTO	126

New	Art. number	Name	Page
Új	Cikkszám	Név	Oldal
Neu	Art. number	Name	Seite

	77106	TARPA	42
	77107	TARPA	42
	77108	TARPA	42
	77109	IBAR	73
	77110	ENOL	36
	77111	ENOL	36
	77112	ENOL	36
	77113	ENOL	36
	77114	MATARO	73
	77115	ZARAGOZA	78
	77116	ZARAGOZA	78
	77117	BATIDA	79
	77118	BATIDA	79
	77119	BATIDA	79
	77120	BATIDA	79
	77121	LAXA	81
	77122	ANKARA	39
	77123	BIRI	172
	77124	BIRI	172
	77125	KELEBIA	58
	77126	DARVAS	34
	77127	DARVAS	34
	77128	DARVAS	34
	77129	ZAVOD	163
	77130	LEITHA	35
	77131	LEITHA	35

New	Art. number	Name	Page
Új	Cikkszám	Név	Oldal
Neu	Art. number	Name	Seite

	77132	LEITHA	35
	77133	LOWAR	112
	77134	LOWAR	112
	77135	LOWAR	112
	77136	LOWAR	112
	77137	LOWAR	122
	77138	LOWAR	122
	77139	LOWAR	122
	77140	LOWAR	122
	77141	MELK	163
	77142	BURDUR	153
	77143	FUNES	152
	77144	FUNES	152
	77145	FUNES	152
	77146	POLPERRO	150
	77147	POLPERRO	150
	77148	WENGEN	31
	77149	WENGEN	31
	77150	RAPLA2	81
	77151	RUST	64
	77152	RUST	64
	77153	RUST	64
	77154	URFA	82
	77155	URFA	82
	77156	URFA	82
	77157	URFA	82

New	Art. number	Name	Page
Új	Cikkszám	Név	Oldal
Neu	Art. number	Name	Seite

	77158	RAVELLO	168
	77159	TARCAL	160
	77160	TARCAL	160
	77161	URFA	83
	77162	URFA	83
	77163	URFA	83
	77164	URFA	83
	77165	ZIRC	170
<b>new</b>	77166	Ispra	158
	77167	SAVOCA	164
	77168	HALLSTATT	67
	77169	HALLSTATT	67
	77170	HALLSTATT	67
	77171	TOLNA	33
	77172	TOLNA	33
	77173	TOLNA	33
	77174	KOBARID	73
	77175	TRILLO	165
	77176	TAPOLCA	164
	77177	MONOR	169
<b>new</b>	77178	Gerla	65
<b>new</b>	77179	Gerla	65
<b>new</b>	77180	Gerla	65
	77181	LOWAR	112
	77182	LOWAR	112
	77183	CUBBINGTON	27

New	Art. number	Name	Page
Új	Cikkszám	Név	Oldal
Neu	Art. number	Name	Seite

	77184	CUBBINGTON	27
	77185	CUBBINGTON	27
	77186	CONG	168
	77187	BOKOD	165
	77188	HOLNE	165
<b>new</b>	77189	Kavala	127
<b>new</b>	77190	Kavala	127
<b>new</b>	77191	Portel	68
<b>new</b>	77192	Portel	68
<b>new</b>	77193	Gordes	37
<b>new</b>	77203	Lermos	156
<b>new</b>	77205	Montoro	158
<b>new</b>	77206	Tamarite	26
<b>new</b>	77207	Tamarite	26
<b>new</b>	77209	Urfa Line	84
<b>new</b>	77210	Urfa Line	84
<b>new</b>	77211	Urfa Line	84
<b>new</b>	77212	Urfa Line	84
<b>new</b>	77213	Lonato	124
<b>new</b>	77214	Lonato	124
	79021	LED STRIP	173
	79022	LED STRIP	173
	79023	LED STRIP	173

New	Name	Page
Új	Név	Oldal
Neu	Name	Seite

	AKRON	95
	ALASKA	155
	ALENZO	101, 106, 107, 108
	ALMADA	44
	AMARILLO	126
	ANDELLE	76
	ANKARA	39
	ANSOO	172
	BALIMO	77
	BATIDA	79
	BELFAST	37
	BIRI	172
	BIRMINGHAM	75
	BLACKTORCH	48
	BOBUS	171
	BOKOD	165
	BONN	49
<b>new</b>	Bradu	66
	BREZNO	157
	BUDAPEST	43
	BUFFALO	85
	BURDUR	153
	CERNON	29
	CHILE	87
	CONG	168
	CUBBINGTON	27
	DANNET	165
	DARIUS	146
	DARVAS	34
<b>new</b>	Dolen	96, 97
	DUBROVNIK	47
	DURANGO	93
	ELVA	37
	ENOL	36
	ERIC	115
	FLAXTON	161

New	Name	Page
Új	Név	Oldal
Neu	Name	Seite

	FOLLINA	63
	FUNES	152
	FUNGHETTO	168
	GAELO	115
<b>new</b>	Gerla	65
	GIMONE	76
<b>new</b>	Gordes	37
	HAGA	147
	HALDEN	80
	HALLSTATT	67
	HEKTOR	146
	HITURA	124
	HOLNE	165
	HORT	125
	IBAR	73
	INDRE	102
	INOXTORCH	50, 51
	INVERNESS	101
<b>new</b>	Ispra	158
	KANGTON	156
	KAPUAS	157
<b>new</b>	Kavala	127
	KELEBIA	58
	KELNA	167
<b>new</b>	Kioni	60
	KOBARID	73
	KOLTA	89
	KOVEN	95
	KROBIA	167
	LARCIA	116, 121
	LASSET	155
<b>new</b>	Lautrec	99
	LAXA	81
	LED STRIP	173
	LEITHA	35
	LENTIL	125

New	Name	Page
Új	Név	Oldal
Neu	Name	Seite

<b>new</b>	Lermos	156
	LIHULL	162
	LIPPA	69
	LISBON	52
	LOANDA	40
<b>new</b>	Lonato	124
	LOWAR	112, 122
	LUBLIN	74
	LUCAS	114, 121
	LUCAS 2	114
	LUTTO	157
	MADRID	140, 141
	MANDAL	88
	MARIBOR	70
	MATARO	71, 73
<b>new</b>	Maurec	98
	MEDINA	86
	MEDNA	28
	MELK	163
	MILANO	132, 133, 134
	MIREO	151
<b>new</b>	Modane	56
	MONACO	130
	MONOR	169
<b>new</b>	Montoro	158
	MORA	166
	MOSELLE	156
	NANTES	167
	NARMADA	156
	NAVIA	63
	NESNA	72
	NORVICH	147
	NOVIGRAD	90
	ODERA	153
	ODESSA	139
	ODIEL	30

New	Name	Page
Új	Név	Oldal
Neu	Name	Seite

	OPAVA	159
	OPOLE	74
	ORLOVA	93
	OSLO	142, 143, 144
	OSTRAVA	159
	PALANGA	32
	PARAVENTO	45
<b>new</b>	Pemba	61
	PERNIK	103
	PHOENIX	88
	POLPERRO	150
<b>new</b>	Portel	68
	PUEBLO	127
	QESA	156
	RAPLA2	81
	RAVELLO	168
	RENNES	75
	RODEZ	75
	ROMA	92
	RUST	64
	SAMIRA	110, 111
	SAVOCA	164
	SENICA	81
	SEPIK	157
	SEVILLA	93
<b>new</b>	Shaun Plus	118
	SILISTRA	90
	SINTRA	85
	SLUIS	164
	SOLAR1	169
	SOLIN	68
<b>new</b>	STUTTGART	117
	TACOMA	127
<b>new</b>	Tamarite	26
	TAPOLCA	164
	TARCAL	160

New	Name	Page
Új	Név	Oldal
Neu	Name	Seite

	TARPA	42
	TARTU	104
	TAVERNA	46
<b>new</b>	Tavira	170
	TELDE	28
	TEMSE	63
	TEPLICE	41
	TILBURG	62
<b>new</b>	TOLNA	33
	Tornio	38
	TORONTO	131
	TOSCANA	138
	TRENTO	126
	TRILLO	165
	TURDA	167
	URFA	82, 83
<b>new</b>	Urfa Line	84
	VALPOVO	163
	VARNA	80
	VELENCE	135, 136, 137
	VIGO	145
	WELLINGTON	89
	WENGEN	31
	WIGRY	171
	YAGO	143
	YOLA	164
	ZARAGOZA	78
	ZATON	91
	ZAVOD	163
	ZENON	115
<b>new</b>	ZERNEST	91
<b>new</b>	Zilina	59
	ZIRC	170
	ZLARIN	163
	ZOMBOR	94

# IMPRINT • IMPRESSZUM • IMPRESSUM

## English

Colour and pattern discrepancy are possible. We are entitled to change the pattern.  
We don't bear the responsibility of the printing failure.

## Magyar

Szín és minta eltérés lehetséges. A minta változtatás jogát fenntartjuk!  
Az esetleges nyomdai hibákért elnézésüket kérjük és azokért felelősséget nem vállalunk.

## Deutsch

Farbe und Musterunterschied ist möglich. Wir halten das Recht von Musteränderung aufrecht.  
Vor die eventuellen Druckfehler bitten wir um Entschuldigung und vor die Fehler können wir die Verantwortung nicht übernehmen.

## Français

Il est bien possible d'avoir quelques alternances de la coloration et du modèle. Nous soutenons notre droit aux changements de modèles.  
Excusez-nous des éventuelles fautes d'imprimerie dont nous ne nous considérons pas être les responsables.

## Česky

Prodejce si vyhrazuje právo průběžně modifikovat své výrobky a tedy údaje uvedené v tomto katalogu mohou být bez předchozího oznámení změněny.  
Tiskové chyby vyhrazeny.

## Slovensko

Obstaja možnost odstopanja pri odtenu barve izdelka. Pridržujemo si pravico do spremembe vzorca.  
Ne prevzemamo odgovornosti za morebitne tiskarske napake.

## Polski

Możliwe są odchylenia w kolorach i wzorach. Podtrzymujemy prawo zachowania zmiany wzoru.  
Przepraszamy, a zarazem nie ponosimy odpowiedzialności za ewentualne błędy powstałe w druku.

## Українська

Можлив зм ни у вз рцях та кольорах. Ми можемо зм нити вз рц на св й розсуд.  
За можлив друкарськ помилки просимо вибачення та в дпов дальност не несемо.

## Română

Este posibilă alternanța model/culoare. Ne reținem dreptul de a schimba modelele.  
Pentru eventualele greseli de tipar, Vă cerem scuze ;dar nu ne asumăm răspunderea pentru ele.

## Srpski

Moguće su razlike u bojama i šarama. Zadržavamo pravo na promene šara.  
Za moguće štamparske greške unapred se izvinjavamo i za njih ne primamo na sebe odgovornost.

## Hrvatski

Postoji mogućnost odstupanja u nijansi boje artikla.  
Ne snosimo odgovornost u slučaju pogreške u tisku.

## Slovensky

Predávajúci si vyhradzuje právo priebežne modifikovať svoje výrobky a preto aj údaje uvedené v tomto katalógu,  
môžu byť zmenené bez predchádzajúceho oznámenia.  
Za prípadné tlačové chyby nenesieme zodpovednosť.

## български

Възможни са промени в цветовете и нюансите.  
Ние не носим отговорност за печатни грешки.

## Lietuvių

Galimi spalvų ir rašto netikslumai. Pasilikame teisę keisti raštą.  
Atsiprašome, bet už spausdinimo klaidas neprisiimame atsakomybės.

## Latviešu

Ir iespējamas krāsas un modeļa neatbilstības. Mēs paturam tiesības mainīt modeli.  
Atvainojamies, tomēr neuzņemamies atbildību par drukas kļūdām.

## Eesti

Värv ja muster võib erineda. Jätame endale õiguse mustri muutmiseks.  
Vabandame, kuid ei vastuta trükkivigade eest.

Grafikai munkák: Visionext Reklámstúdió  
Nyomdai munkák: Keskeny és Társai 2001 Kft.





# OUTDOOR LIGHTS OUTDOOR LIGHTS

**OUTDOOR  
LIGHTS**

**2026**

[www.rabalux.com](http://www.rabalux.com)