

Unica

A new era in terms of design,
sustainability and advanced functions.



se.com

Life Is On

Schneider
Electric



General Contents

Presentation	4
Unica Inserts	66
Unica Inserts with Fixing Frame	88
Unica Inserts with Fixing Frame and Claws	98
Unica Complete Offer: Inserts with Fixing Frame and Cover Frame	104
Unica Installation: Fixing Frames and Boxes	108
Unica Cover Frames	114
Unica Wiser	122
Unica KNX	130
Unica Antibacterial Offer	134
Unica System+	148
Unica Technical Information	154
Unica Index	176



Breakthrough design

Products designed to be easy to install in your customers' homes, while bringing sophistication and freshness to their interiors.



Sustainability

A range that respects environmental needs throughout its life cycle, for eco-friendly customers.



Advanced functions

A range designed to meet all your customers' needs, whether in terms of comfort, energy efficiency, connectivity or design.



Schneider
Electric

A range
like no
other



Give your projects a head start with Unica

Pushing back all the limits.

This is what the Unica range invites your customers to do.

A design breakthrough, an always further sustainable conception, and the same highest standard advanced functions: Unica reinvents itself and brings your clients' project several steps further, where none has ever explored yet.

With its latest Unica Deco series of cover plates, the range is enriched with a new, almost infinite, potential.

Its unprecedented straight lines and sharp edges allows you to offer a yet unseen design intent to your clients. Audacious and classical at the same time, Unica Deco opens new ways to make home interiors more eye-catching than ever.

Beyond its look, the whole range has been designed to meet your clients' increasing expectations for sustainability. From production to the final installation, Unica has been developed with low environmental impact in mind.

Ready to re-discover The Unica range?

The journey begins here.





Lines
to highlight
your
clients' life.

Home has changed. It is still the place where families gather and live, of course. But over the past years, it has also become office, meeting room, cinema...

For your clients, home is life's main décor. Hence the importance for them to feel good in it.

Today, there is a way you can make their home the perfect inspirational place:

Unica Deco.

Unica Deco – The latest and utmost elegant version of an iconic range.

The very best of the past Unica range...

Unica Deco is the latest evolution of the Unica range. It's a full range of cover frames that has been thought through down to the last detail, offering unmatched modularity.

Designed in its usual 45x45 format, Unica Deco is compatible with all types of architecture. Robust, ergonomic and varied, it displays new finishes, offering your clients optimized solutions for all uses.

Moreover, Unica Deco's cover frames are easy to install. For your renovation works, they can be simply clipped on any Unica function. For you, it's the perfect combination to cope with any installation configuration. And always with style.

... With a new, unique touch of elegance.

More elegant, more sober in terms of shapes, it is directly inspired by the Bauhaus philosophy. More than a new range, it's a step toward a real art de vivre, specifically made for today's home life.

A renewed collection, an upgraded lifestyle.

With its simplified yet elegantly renewed design, it gives you the opportunity to uplift your client's interior and make it an extension of their personal inspiration.

From Bauhaus to interiors' design.

The Unica Deco collection takes its inspiration from the famous German Bauhaus art school, founded in 1919. It has inherited from its simple and straight lines and its attention to link both shape and function in order to make every moment of life not only more elegant, but also easier for your clients.

14 cover plates to make each inspiration unique.



Why choosing a mere equipment range when you can pick a design breakthrough? The new Unica Deco range displays pure, straight and geometric lines that suit in any kind of interiors. Even better: this new collection enhances the very idea of home elegance. Its 3 layer lines bring a unique dynamic and add personality to any décor thanks to their straight shapes and delicate textures.

With its modern flair and its refined aesthetic, Unica Deco definitely adds a touch of difference to any interior.

Rule-breaker? Trend-setter?

No need to choose: in terms of design, Unica Deco's latest evolution is both of them. Now, it's all up to you to use it to make your clients' life always more elegant.



The Signature Layer

These hi-end plates combine natural colours with delicate textures, to provide an authentic feel.



SLATE



TERRACOTTA



TRANSLUCENT WHITE



RUBBER



CHIPPED WOOD



The Subtle layer

With its slightly differentiated plates, it offers an accentuated and dynamic profile thanks to its coloured vertical grooves.



WHITE AND COPPER



WHITE AND SILVER

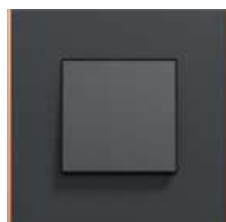

ANTHRACITE AND COPPER



ANTHRACITE AND SILVER

The Essential layer

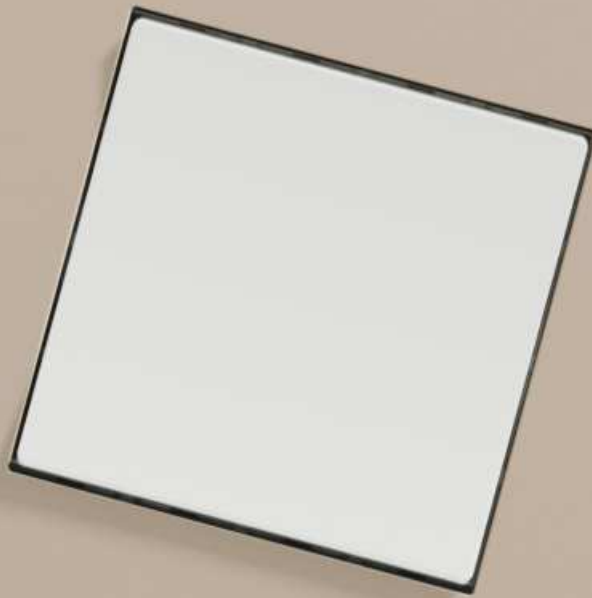

This design takes sobriety and minimalism a step further, thanks to its mild yet trendy colours.



ANTHRACITE



ALUMINIUM



TAUPE



LIGHT GREY



WHITE

Unica Deco – Designed for a greater sustainability.

Your clients are more and more sensitive to ecological issues. For them, sustainability has become a major selling point. On this subject, Unica Deco has some strong arguments. From end to end, the full range is eco-designed, aiming to reduce its environmental impact.

0 waste to landfill.

50% and more of raw material coming from recycled sources.

60% less chemical substance discharged.

Fully recyclable plastic for 3 models.



70% recycled cardboard packaging.



A range manufactured using renewable energy.

It all starts from its first manufacturing steps: the entire range is manufactured in a factory that uses 100% renewable electricity for production.



External certifications.

Cradle to Cradle® defines and promotes the development of upcyclable products. It aims at maintaining the quality of the raw materials throughout the multiple life cycles of the product and its components. Therefore, this certification goes beyond conventional recycling.





And end to end eco-designed range.

From packaging to everyday use:
Unica Deco's full range has been
thought through to help reduce its
environmental impact to the max.

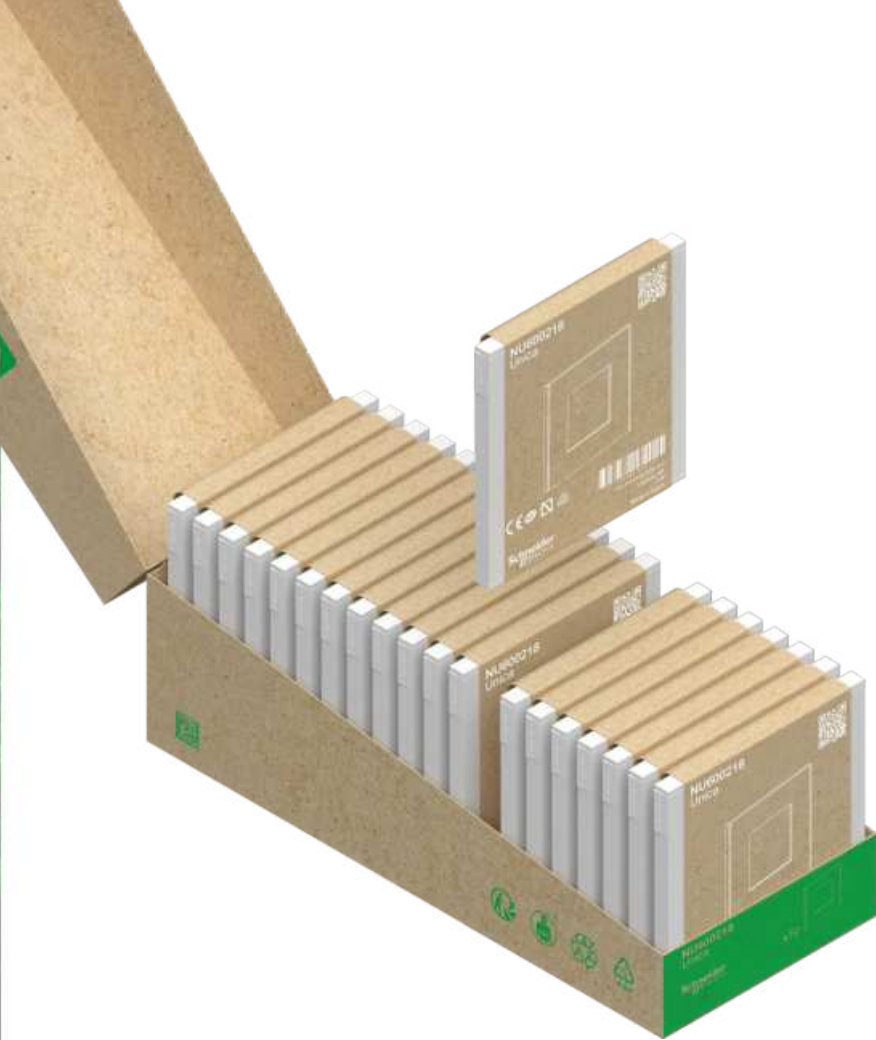

Environmentally responsible packaging.

More compact, without any individual cardboard packaging and 100% plastic-free, this packaging solution helps reduce wastes and makes their management much easier for you. Chemical paint is gradually being replaced by vegetable oil-based ink.

It helps saving up to:

60% in water consumption and discharged (per box).

60% less chemical substances discharged (per box).

120.000

labels removed each year, with laser printing.

Made with recycled material.

Unica Deco frame White, light grey, White and Silver, White and Copper are made of 45% recycled plastic. Using recycled plastic helps to reduce the amount of plastic ending up in landfills and oceans, contributing to a cleaner environment. Additionally, it requires less energy to produce, lowering carbon emissions and conserving natural resources.



WHITE



LIGHT GREY



WHITE AND COPPER



WHITE AND SILVER

As a conclusion...

Unica Deco has been developed in order to line up with Schneider Electric's commitments for the environment, which are at the core of the group's purpose. Its ambition: become a Net-Zero company across the entire value chain by 2050.

With Unica Deco, your professional proposition goes far beyond installing a mere electrical equipment: you present a solution aimed at fully meeting tomorrow's challenges. In the eyes of your clients, it gives to your work a higher, even more respectable value.



Help your clients combine comfort and energy savings.

Unica Deco is compatible with smart home solutions such as Wiser and KNX, enabling you to lay the foundations for an intelligent building that constantly adapts to the requirements of its occupants in terms of comfort, energy performance and ease of use. For your clients, it means combining a lesser energy consumption with a ever more comfy life.

Too good to be real?

Not with Unica Deco.



the perfect solution for your residential projects.

Compatible to the Wiser ecosystem, Unica Deco gives your clients total control over lighting and roller shutters quickly and easily, even remotely.

For them, it's the perfect solution for controlling their energy consumption on a daily basis.



the solution adapted to bigger commercial buildings.

Connected to KNX technology, Unica Deco keeps your clients informed about changes in the building in real time: occupant activity, period of occupation of different zones, etc.

Collecting this data means you can fine-tune of the building. For your clients, it's a guarantee of energy efficiency, a vital element in the overall context of sustainable development.

The right function at the right time for everyone at home.

Thermostat, lighting, opening doors, USB chargers, Wifi repeaters, TV sockets, Hi-power USB chargers... It's simple: with its connection to smart home solutions, Unica Deco covers every need in a household.

Whether for office hours, a home-cinema session or simply for chilling out, the range offer a wide range of functions as well as a large modularity.

What easier or more sustainable way for your clients to feel good, whether at home or at work?

Keep in line with the latest trends and technologies.

As well as offering you innovative, responsible and attractive solutions, Schneider Electric is always at your side to help and support you on a daily basis.

With mySchneider app, get permanently connected to Schneider Electric.

The latest news, the points of sale around you, the events and the last products... All of it in your pocket, thanks to the mySchneider app.





The presentation case, to help you convince your clients.

It's simple: with this case, you get all the Unica finishes at your disposal. With a single gesture, you can present them in their entirety to your customers. Simple, comprehensive and effective. Just like the range.

The general catalogue: all the solutions at a glance.

With our catalogue, the essential tool for your worksites, you can access all our products quickly and easily.

The information it contains will make your day-to-day work more efficient: technical content, overview of offers, new products, etc.

And contents to be content with.

Take advantage of a wealth of content to simplify your day-to-day work on all your new-build or renovation residential projects.



Modern

Aluminum finishings are always a good idea to add modern touches to any space.

Aluminum



Earthy

Earth colors will never go out of fashion and that you will never tire of.

Taupe

Matt and Classy

The timeless white brings freshness and elegance to any room.



White

Elegance

What would design be without anthracite? Chic and smart, it goes well with everything, especially waxed concrete.



Anthracite

Unica Studio

Add character to interiors with signature rounded frames.

Enjoy timeless, universal design

The Unica Studio range gives your customers a selection of frames to easily match different types of interiors, from minimalist to traditional. Made from high-performance thermoplastic, they're robust and long lasting.

The Unica Studio range comes in two versions.

Single-volume frames are available in solid colors (white, beige, aluminum, and anthracite).

The double-skin version has frames composed of a colored or metal layer over a white, beige, or anthracite base (see Unica Studio Color and Unica Studio Metal).



Unica Studio

White



Unica Studio

Beige



Unica Studio

Anthracite



Unica Studio

Aluminum

Single-volume frames

The white and beige frames have a mirror-polished surface for a nice glossy finish and are a perfect fit for lighter interiors with brighter wall colors.

The anthracite and aluminum finishings work for darker interiors or as bold color accents. The anthracite frames have a soft-touch perception, while the aluminum ones add a bit of shine.



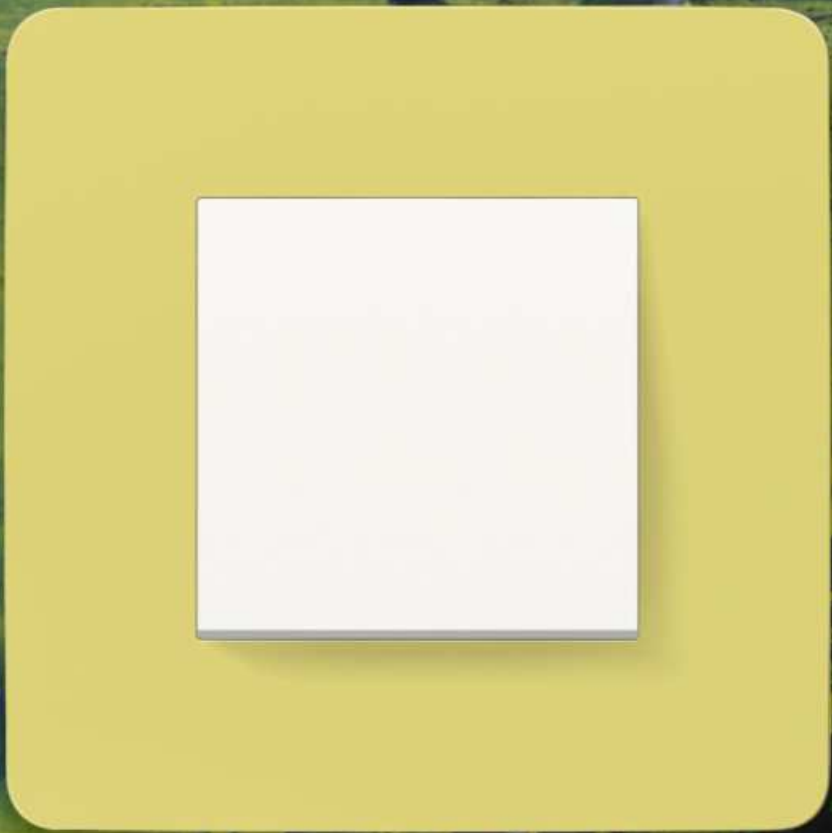
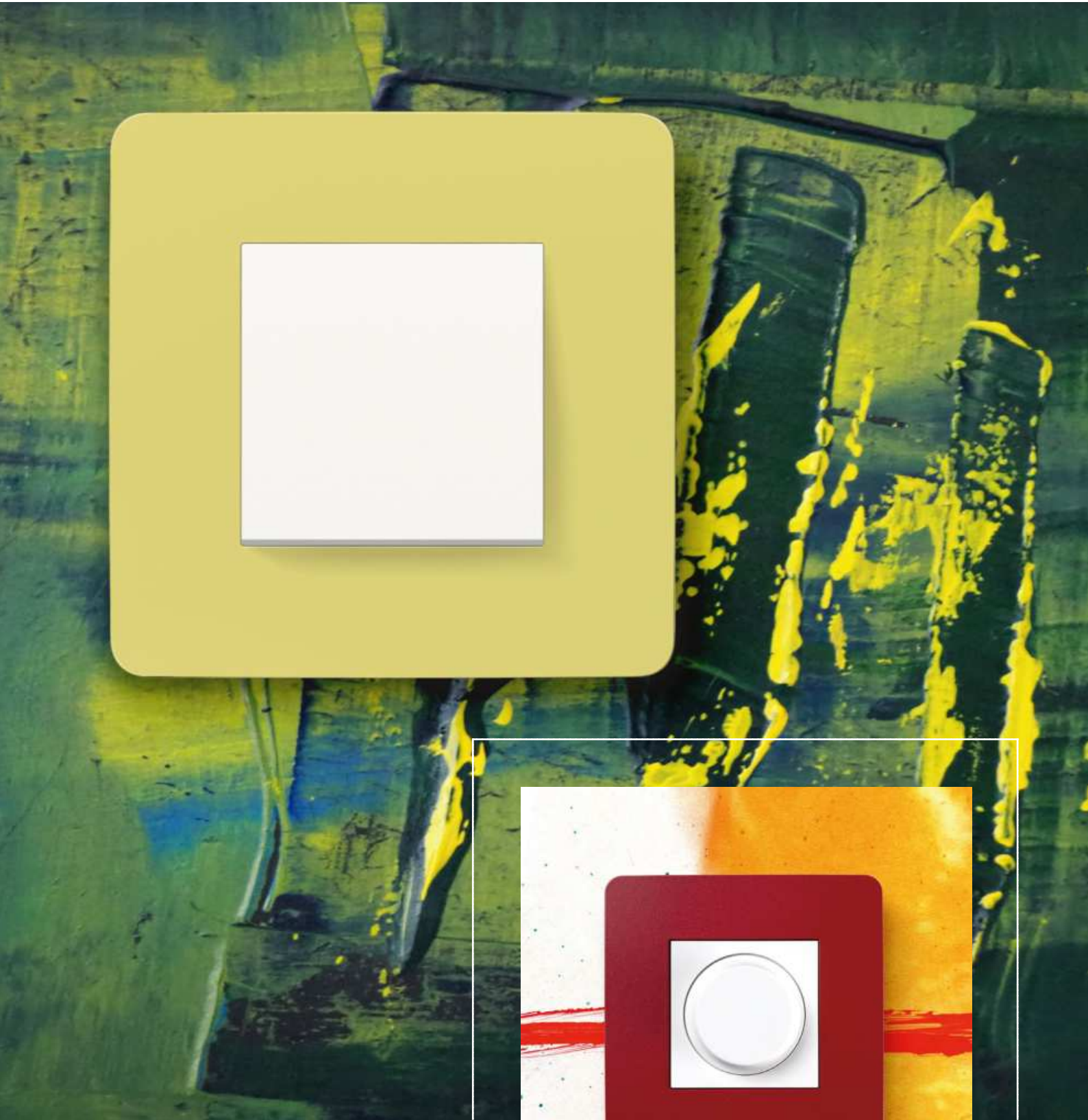



Unica Studio Color

Invigorate any room with a splash of color.

With nine colors available – from soft and light, to bold and lively – the Unica Studio Color range offers a hue to complement any decor or style. Add to that a modern shape and smooth, curved surface, and your customers get perfect switches for energetic interiors.



Unica Studio Color
White



Unica Studio Color
Beige



Unica Studio Color
Light gray

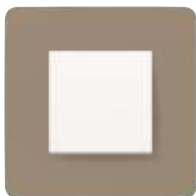

Unica Studio Color
Taupe



Unica Studio Color
Light green



Unica Studio Color
Red

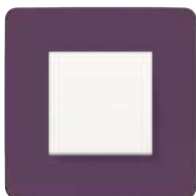

Unica Studio Color
Plum



Unica Studio Color
Dark gray



Unica Studio Color
Chocolate

Unica Studio Color double-skin frames have metallic particles added to the two layers of paint to add depth to the colors and create a more dynamic appearance.

Unica Studio Outline

Enrich your designs with a subtle color accent.

The Unica Studio Outline frames comes in neutral white with a touch of color added by a delicate outline on the frame. Ten outline colors, from vibrant yellow to moderate gray and beige, give your clients a broader palette to elevate interior designs while keeping them well balanced.



Unica Studio Outline
White

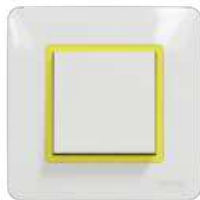

Unica Studio Outline
Yellow

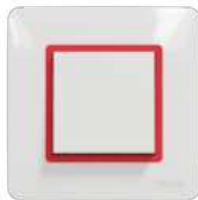

Unica Studio Outline
Red

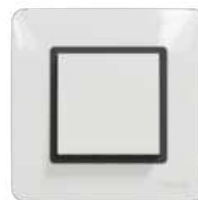

Unica Studio Outline
Anthracite

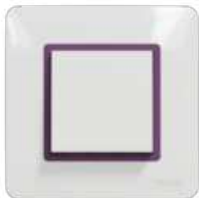

Unica Studio Outline
Plum

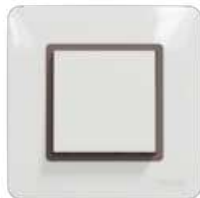

Unica Studio Outline
Chocolate



Unica Studio Outline
Beige



Unica Studio Outline
Light gray



Unica Studio Outline
Gray



Unica Studio Outline
Aluminum









Unica Studio Metal

Give home interiors
a modern edge.

The Unica Studio Metal range features five ultra-modern metal finishes that combine quality and robustness with elegant design.

The frames are made of sheet metal with an anodized finishing to create a bright smooth surface. An additional high-resistance treatment helps ensure a lasting look by minimizing the impact of aging and environmental conditions.

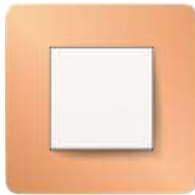

Unica Studio Metal
Copper



Unica Studio Metal
Gold



Unica Studio Metal
Bronze



Unica Studio Metal
Dark Aluminum



Unica Studio Metal
White Aluminum



Unica Pro

Achieve the perfect balance.



Antibacterial
White



Unica Pro
White



Unica Pro
Aluminum



Unica Pro
Anthracite

The Unica Pro range provides the perfect balance of style and functionality. Its signature design, with a ring surrounding the frame, makes the frames stand out from the wall and adds a smooth, light perception to them.

Available in white, aluminum, and anthracite, Unica Pro frames satisfy all essential style needs.



Antibacterial

The Unica Pro range also includes devices with a white antibacterial finish for those mindful of hygiene and safety (find out more in the “Antibacterial for greater peace of mind” section).

Unica leaves nothing to be desired.

The new Unica range includes all the wiring devices you need to enhance the style, comfort, and safety of your customers' homes.

From lighting control to entertainment system connections and smart home functions, Unica is ready to meet your clients' current and future needs.





Lighting control

Automatic light control with motion sensors improves safety and energy efficiency.

Rotary and pushbutton dimmers, compatible with both conventional and LED lighting, help easily adjust the ambiance.

Connectivity-ready switches, dimmers, and motion sensors can be easily integrated with the Wiser smart home system. A wireless Free Located switch can be used with Wiser to control lights and shutters from anywhere.

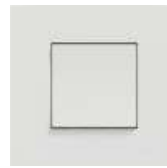

Switch



Bedside lamp with USB

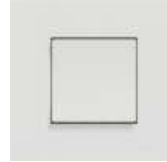

Connected pushbutton dimmer



Motion sensor (connected and non-connected)



Connected Free Located switch



Rotary dimmer (connected and non-connected)

Shutter control

Manual-at-a-push control or fully automatic via Wiser, allows your clients to create moments and automations to increase comfort.

Shutters can also protect home interiors from excessive sunlight and help discourage unwanted interest from strangers.



Shutter control



Connected shutter control



One-module shutter control

Temperature control

Unica thermostats can set a temperature and maintain it at a comfortable level as the outside temperature fluctuates, while also helping to reduce energy costs.



Thermostat

A worldwide range.

To cater to different standards worldwide and diverse homeowner needs, Unica provides a broad selection of socket outlets.

All socket outlets have integrated child protection. The self-sealing shutters sit behind the electrode holes and close when the plug is removed, reducing the risk of a child inserting something into the holes.



Socket outlets for diverse needs and standards

Unica features standard socket outlets with lid and surface socket outlets that provide high aesthetics and prevent dust accumulation inside the outlet.

For extra safety, socket outlets with surge protection are available. The IP44 devices can be used outdoors (see the “Robust and weather-resilient” section).

The range features socket outlet versions available in almost all of the local standards (see Unica catalog for the full collection).



Side earth outlet



Side earth socket with lid



Surface pin earth socket



Socket with surge protection



Multistandard socket



British socket



American socket

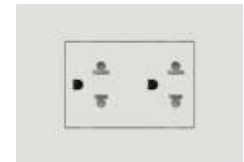

Euroamerican socket 3 modules

Connected socket outlets

Connected to the Wiser by SE app, the connected socket enables advanced functionalities like remote load control, scheduling and energy monitoring.



2P+T socket



Connected socket

Socket outlets with USB

Sockets with an added USB-C port provide maximized flexibility and use of space.



Surface pin earth socket with USB



Side earth socket with USB



Technology that connects.

With an array of devices facilitating connectivity, Unica helps ensure your customers can use digital technologies in every corner of their house, without having to worry about low battery levels or network reach.



USB chargers

USB chargers include a quick charging option up to 18 W (3 A), with type A and type C ports which can charge a battery up to 75 percent in as little as 30 minutes.



USB A+C



USB A+C



USB 65W



Side earth socket with USB type C



Surface pin earth socket with USB type C

Connect to your customer's world

The Wi-Fi repeater makes the internet available throughout the house. The range also includes R/TV sockets, RJ45 inserts and central plates as well as HDMI sockets to neatly connect HDTV and AV components.



Wi-Fi repeater



HDMI outlet



R-TV/SAT outlet



RJ45 data socket

Robust and weather-resilient.

With Unica, your customers can provide convenient power access and connectivity even outdoors.



IP44 switch



IP44 socket outlet



IP55 Mureva box
compatible with
Unica



IP55 cover frame

Outdoor devices

From IP44 switches and sockets to IP55 frames and compatibility with Mureva boxes, the range has devices to fit balconies, terraces, and gardens.



Sustainable and Smart homes

By choosing connected Unica devices that work with Wiser, you are helping your customers to make their home more comfortable while helping reduce energy use and costs.



From busy schedules and endless to-do lists to high energy bills, everyday life at home can get the better for your customers. Wiser is here to help them live more comfortably and more efficiently – with minimum effort.



Energy efficient...

...to help your clients reduce their energy bills and live more sustainably.

Designed for a customized experience...

...so your customers can maximize comfort at home with intuitive control.

Modular and long-lasting...



...to create a durable solution that evolves with their needs.



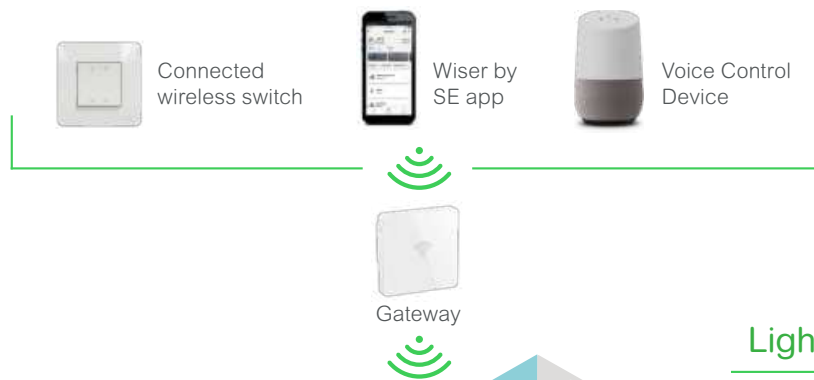

Wiser is compatible with Amazon Alexa™, Google Assistant™, and Apple's Siri®.







Energy management

-  EVlink Home Smart
-  PowerTag Energy Sensor
-  Side earth outlet
-  Smart Plug

Temperature control

-  Wiser Flush-mounted Thermostat 16 A
-  Wiser Radiator Thermostat

Lighting and shutter control

-  Connected push-button dimmer
-  Rotary dimmer (connected and non-connected)
-  Connected socket
-  Connected wireless switch

Safety and security

-  Wiser Water Leakage Sensor
-  Wiser Window/Door Sensor
-  Wiser Temperature/Humidity Sensor
-  IP Camera Outdoor
-  IP Camera Indoor
-  Wiser Motion Sensor
-  Smoke Alarm

Energy savings

With Wisier, your clients have in-depth visibility of their energy consumption, so they can use energy better and more efficiently.

Home energy management

Your clients can use Wisier energy insights to minimize their energy costs by taking advantage of the best electricity tariffs and avoiding exceeding their power usage limits.

Energy dashboard

Offer a clear view of how they use energy to make better-informed decisions, change their habits, and keep their budget under control.

Room-by-room temperature control

They can adjust heating in every room individually, or turn it off while they're out via the Wisier by SE app to avoid wasting energy.

Moments and automations

They can save energy with customizable pre-set actions. For example, they can set up the lights to switch off if no motion is sensed for a predefined time.



Greater comfort

With Wisier, your clients can choose the most convenient way to manage their smart home system. That could be via the Wisier by SE app, a leading voice assistant, a wireless Switch, or automations. Or maybe traditional manual control. It is their choice.

All-in-one app

The Wisier by SE app allows your clients to manage all their Wisier functions, like energy, heating and cooling, safety, lighting, and shutters, directly from their smartphone. The app also includes advanced user access settings and links to Wisier tutorials and support.

Moments

They can create personalized Wisier Moments for all kinds of scenarios and situations in their home. A "Moment" enables them to set a

specific scene – for example a "Movie Moment" can dim the lights and close the shutters so they are ready for a movie night. They can activate it manually, with a voice command, or turn it on automatically via a schedule.

Notifications

Wisier notifies your clients of abnormal events such as high humidity, smoke, water leakage, unexpected motion, or unusually high energy use, so they can address the issues before they turn into costly emergencies.





Durable solution

Wiser is a modular, flexible system that lets your clients start small and expand later as they wish. For example, they may begin with lighting control, then add more Wiser functions. Robust and made with high-quality components, Wiser will serve your clients for years to come.

Robust connectivity

Wiser is based on a mesh network protocol (ZigBee) that helps ensure uninterrupted system service. If one device disconnects, other devices can still communicate with each other.

Regular updates

Frequent software updates keep Wiser in line with top-class security standards and helps provide advanced functionality and compatibility with third-party devices.

A partnership ecosystem

The Connectivity Ecosystem Partnership of Schneider Electric and third-party companies helps ensure seamless interoperability between Wiser and other smart devices.

Quality

Wiser's quality systems from Schneider Electric's long experience in the residential market. Wiser devices comes with transparent product information guaranteed by the Green Premium™ ecolabel.

Scalability

With ready-to-use connected devices that can be freely combined, Wiser is easy to set up and upgrade anytime your clients needs.



Antibacterial for greater peace of mind

For where hygiene is especially important, like a baby's room or the kitchen, the Unica range provides devices with antibacterial properties.

To enable these properties, the raw plastic material has been enriched with silver ions. All external surfaces of devices are made from antibacterial material that's fully compliant with the latest international standard, ISO 22196:2011*.

87%

of tested bacteria gone after 8 hours*

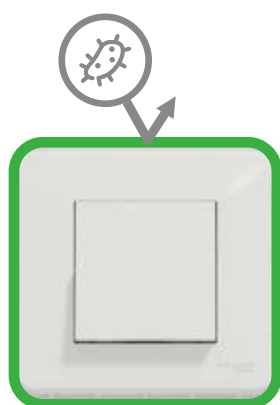

Silver ion technology

Silver ions act as a long-term barrier against bacteria, stopping their growth and spread.



22196:2011

* Testing done by an external laboratory. As per ISO 22196:2011 requirement, the microorganisms tested were Escherichia coli and Staphylococcus aureus.

Unique in the market, the antibacterial range includes a wide variety of functions, from regular switches and sockets, to connected devices. What's more, your clients don't have to compromise on aesthetics for greater safety. The range features the same elegant design as the regular white Unica devices.



Antibacterial

All products have the antibacterial logo visible.



Switch



Universal dimmer



Shutter control



Pushbutton with a label holder



Side earth socket

Other functions also available in the antibacterial finishing

Expand your customers' possibilities with the new Unica range

Take advantage of Unica's comprehensive collection of styles and functionalities to meet – and exceed – your clients' expectations.

With Unica, your clients will find a complementary range for any of your customers' space and decor. And you can offer them something more, like energy savings, thanks to connected functionalities compatible with smart home systems like Wiser and KNX.

Simple yet exceptional, Unica wiring devices helps you deliver truly unique home designs with future-ready comfort and convenience.





Workspaces tailored to any need

The Unica range provides the full scope of functions needed in a modern office. Socket outlets, network connectivity, multimedia outlets, and more. What your client needs, Unica delivers.



Single, double, and triple socket outlets

A selection of different outlet configurations lets you flexibly adapt to customer demands. Choose from socket outlets with screw and screwless mounting and double socket outlets with an IPT connection. All are simple to install. Color options are available.



Surface-mounted socket outlets

For areas with no dust allowed, surface-mounted sockets are a perfect choice. With an enhanced design, the outlets have a sleeker look for improved workspace aesthetics.

All Unica functions are compatible with Unica System+ devices, including workstations, floor boxes, desk units, poles and posts, and cable management solutions. Function modules can also be directly clipped into OptiLine 45 trunking for a seamless and highly aesthetic look.

EVERYDAY YOUR WAY



Motion sensor



Rotary dimmer

Light control functions

Rotary and pushbutton LED dimmers enable your customers to adjust the brightness of lights in areas like meeting rooms.

Motion sensors installed in areas like corridors or toilets help ensure the lights are on only when needed.

For more energy savings, a programmable timer can be used to switch off office devices, such as printers, during non-working hours.

Light control functions

From devices dedicated to USB charging to regular sockets with in-built USB slots, the Unica range provides powerful flexibility.

A quick charger with USB A and C can charge a battery up to 75 percent in as little as 30 minutes. Two different slots mean customers can charge diverse types of devices. The compact design and dual-charging options help maximize the use of space.

Another space-saving option is a one-module USB charger that can be used in workstations, for example.

A regular socket outlet with a USB-C port pulls double duty, powering electrical equipment and charging USB devices simultaneously.



HDMI outlet

Multimedia outlets

Unica provides a complete set of multimedia outlets to cover any functionality needed in a meeting room. The devices are quick and easy to install and can be seamlessly integrated into the environment.

EVERYDAY YOUR WAY

Network connectivity

The full Unica network connectivity offer works with any Schneider Electric S-One connector and is also compatible with Keystone and SYSTIMAX connectors. Available in different sizes and two versions, inclined and flat, the modules can fit any application. Narrow modules are available in 45x45 mm size and standard modules in 45x90 mm size perfect for vertical workstations or poles and posts.



Flush mounting workstation



With a broad selection of modules, you can easily find a solution for a specific application.

Switches and socket outlets for outdoor and special areas

Unica devices are also available with IP44-rated protection. They have the same stylish appearance as regular switches and sockets but are more resistant to dust, water, etc.

IP55-rated frames are perfect for bathroom installations, while Unica devices combined with Mureva Boxes can be used for example in parking lots.





Maximized functionality, minimized space

When space is at a premium and you have multiple functions to fit, Unica System+ workstations come to the rescue.

Available in multiple sizes, in vertical or horizontal formats, for flush or surface mounting, these workstations help you deliver flexibility and convenience for office occupants.

Three color options – white (also available in antibacterial finish), aluminum, and anthracite – perfectly match Unica frames and help you create a uniform interior aesthetic. Unica System+ workstations are compatible with all function inserts offered by the Unica range.



Unica System+ workstations are also available in a white antibacterial finish (find out more in the “Make the office a safer space” section).



Flush mounting workstation
White



Flush mounting workstation
Aluminium



Flush mounting workstation
Anthracite

	Vertical	Horizontal
Surface		
Flush		

EVERYDAY SIMPLE

Ingenious design

Unica fixing frames as well as modular switches and sockets are designed to make installation smoother than ever.

Easy installation

More compact inserts with extra space for wiring and easy-to-access release buttons are just two examples of the clever features that help you save time on mounting.

Easy clipping

The size of Unica inserts allows for direct clipping in the OptiLine 45 trunking. This major simplification means one insert type can now be used for both homes and commercial buildings.

“

One of the most important features we instilled in Unica is ingenuity so the electrician could install more devices faster through the simplicity of design. ”

Frédéric Beuvry,
Vice President Industrial Design & Ergonomics
at Schneider Electric



Install faster and smarter

Speed up your work with the ingenious features of Unica wiring devices.

Fixing frames

Flexible installation
Thanks to symmetric fixing frame sides.

Secure fixing
Finer tolerance between the fixing frame and the insert. Less dangling, as the insert sits securely in the fixing frame.

Robust design
The Unica fixing frame is bigger and more rigid due to the smaller 40 x 40 mm insert window. This provides extra strength to the frame to help prevent distortion during fastening the clips.

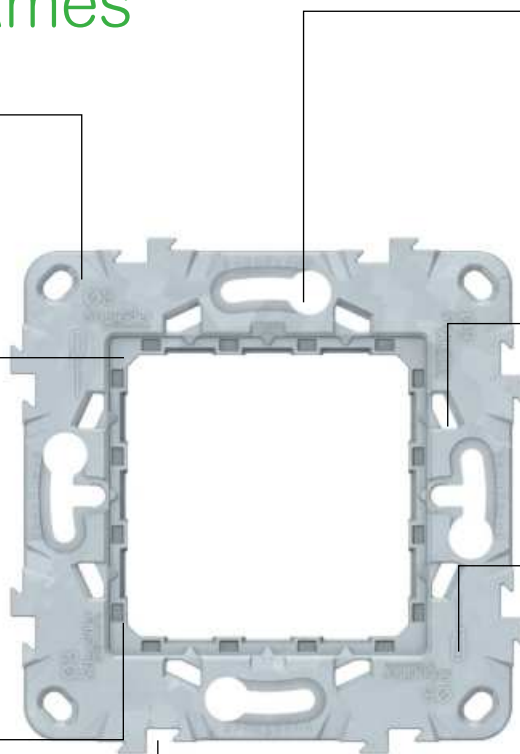

Easy adjustment
The screw slots allow rotation of the fixing frame in either direction, so the frame can be correctly mounted even if the installation box is misaligned. These slots are a perfect fit for flush-mounted box standard screws, so fixing is now even easier and more secure.

Stronger connection
Finer tolerances between the fixing frame and the cover create a stronger connection for more reliable installation.

Intuitive mounting
Slots for the screwdriver on the front and back of the fixing frame enable removing the insert without leaving a mark on the product. They also help avoid injuries from placing the screwdriver in the wrong position. Inserts can be easily removed from the front and back.

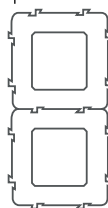

Perfect alignment
Unica's interlocking system helps avoid misalignment and slipping when installing two or more products in a multi-gang frame.

Safe handling
The claws are protected with a plastic cover to prevent harm during installation.



Reliable fixing
The claw length has been increased for better fixation in the box. When you hear a click sound, you know the claws are perfectly placed in the fixing frame. The claws are only valid for CE60 Zamak fixing frames.



Multiple versions

Fixing frames are available in plastic and zamak and with or without claws included. Available also for 1 to 7 module installations, and also for Double British Standard boxes.



Plastic fixing frame
2 modules



Plastic fixing frame
3 modules



Plastic fixing frame
4 modules



Plastic fixing frame
for Double British
Box



Zamak fixing frame
2 modules



Zamak fixing frame
3 modules



Zamak fixing frame
4 modules

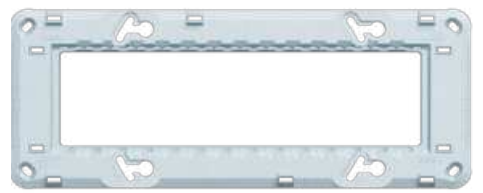

Zamak fixing frame
7 modules

Switch to smart design

Extra space

A low mounting depth of 21 mm provides more space for wiring.

Easy removal

Inserts can be removed from the front and back thanks to the clearly visible notches.

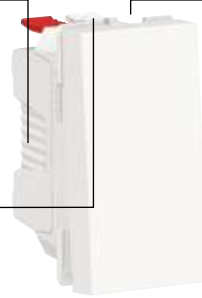

Secure clipping

The insert is more secure in the fixing frame due to the improved design of the clipping system.

Clear on/off status

The large rocker clearly indicates the status of the switch in the 'on' and 'off' positions. When switched off, the rocker angle is wider for increased separation of the contacts. This helps avoid electrical arc, makes the switch more secure, and improves its electrical performance.

Quick wiring

Prominent quick release buttons are easily accessible, so securing and releasing wires is quick and easy.

Simple connection

A wiring diagram is printed on the rear of the switch and pushbutton base to make connection options clearly visible.

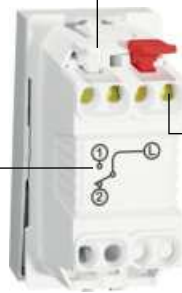

Effortless wiring

Conical cable entries make it easier to feed the connection wires into the terminal blocks. Even thicker wires can be connected in less time thanks to the larger openings.



Easy indicator conversion

Add an indicator lamp to any switch, easily. Simply remove the standard rocker and add the accessory lamp and the rocker with a light window.

Convenient testing from the front

Checkpoints at the front allow convenient functions testing and measuring. Plus, there's no need to disassemble the switch – the rocker can be easily removed to access the checkpoints.



Special functions



One-way switches and pushbuttons

For one-way switches and pushbuttons, the phase and neutral cable entries are on the top. This allows for simpler and faster wiring, without having to turn the insert to wire the other cable.

Slim insert

All white switch inserts come with a smaller housing which offers more space for fast and easy wiring.



Intermediate switch

Different colors indicating the two circuits make it easy to distinguish between them for simpler installation.

Upgradable pushbutton

All switch inserts with aluminum or anthracite rockers can be upgraded to a pushbutton thanks to a larger housing and a pushbutton spring.

Sockets with screw terminals

Extra space

A shallow mounting depth of 21 mm provides extra space for wiring.



Easy removal

Inserts can be removed from the front and back thanks to the clearly visible notches. The center plate can also be removed easily.

Unclipped center plate

The center plate is unclipped, enabling easy removal of wiring.

Shock protection

Integrated shutters protect against accidental contact and the ingress of foreign objects.

Large cable entries

Entries allow for wiring rigid and flexible cables of 2.5 mm² and 4 mm².

Fast wiring

With the cable entries beside each other, you can cut all wires to the same length. The screws are unfixed, so you don't have to unscrew them before you start to wire the cables.

Improved protection

Cable entries are clearly separated to make wiring more intuitive and help avoid short-circuit risk when flexible wires are used.



Sockets with screwless terminals

Extra space

A low mounting depth of 21 mm provides extra space for wiring.



Easy removal

Inserts can be removed from the front and back thanks to the clearly visible notches. The center plate is also easy to remove.

Shock protection

Integrated shutters protect against accidental contact and the ingress of foreign objects.

Effortless wiring

Conical cable entries make it easier to feed the connection wires into the terminal blocks. Thanks to larger openings, even thicker wires can be easily connected.

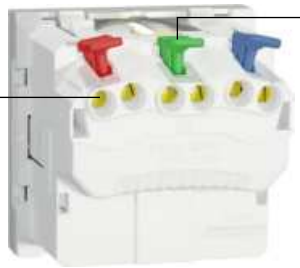

Quick wiring

Screwless socket outlet terminals and color-coded quick-release buttons make securing and releasing wires quick and easy, without removing the center plate.

Special socket outlets



Socket outlet with lid which can be opened to 180°



Double socket outlet

The new Unica range includes socket outlets for a variety of applications, including single, double, and multi-gang outlets. They offer screw and screwless options, with extra room and wider openings for quicker, simpler wiring.

Versatile workstations

With Unica System+ workstations, available as both flush- and surface-mounted, in vertical or horizontal orientation, in several sizes and finishes, you will easily deliver the right solutions for any workspace.

Flush-mounted box

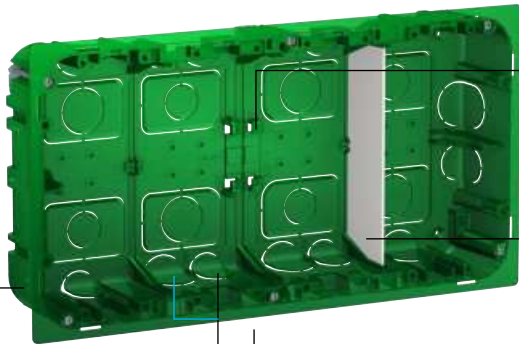

Holes for 25 mm Ø and 20 mm Ø tubes.

Easier data cable installation
Box depth of 50 mm for easier installation of Cat6 and 6 A data cables.

Broad flat frame
Enabling perfect installation, even when the walls are uneven. The broad frame also stands proud of slightly larger holes to avoid "falling".

Surface-mounted box

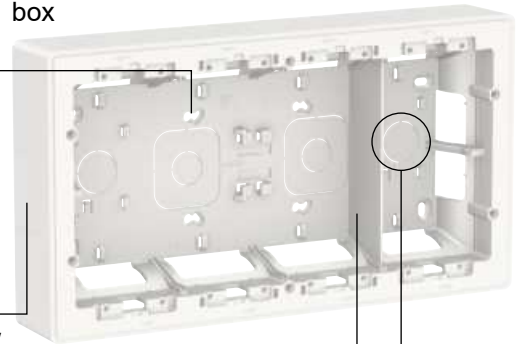

Easy adjustment
The mounting holes allow vertical and horizontal movement to balance the boxes for perfect alignment every time.

Flexible installation
Several entrances allow mounting without drilling.

Added security
Slide-in dividers keep power and data cables separated for extra safety.

Flush-mounted box compatibility
Workstations can be placed in a flush-mounted installation box instead of bringing the cables in via the mini-trunking. The box features entry holes for the cables.

Faster installs
The boxes come with pre-mounted and unscrewed screws to speed up installation.

Easy fixing
The fixing frames can be clipped directly to workstations, without tools.



Fixing frame

Flexible clipping
Small bars allow single inserts to be clipped in and removed with greater flexibility. The bars allow any Unica insert to be fitted into the boxes.



Design frame

No adaptors needed
The removable bar on the fixing frame allows secure fixing of single functions without an adaptor. You can also clip in one- or two-module inclined RJ45 connectors to the workstation.

Mini-trunking compatible
Unica System+ products are compatible with Schneider Electric mini-trunking.

DIN-rail ready
The use of an adaptor allows mounting of DIN-rail products such as Acti9.

Connect multiple boxes
A small adaptor allows connecting of several boxes.

Special functions for commercial applications

Unica System+ and OptiLine 45 trunking accept all Unica inserts. For faster installation, double- and triple-socket outlets and RJ45 inserts with two or four connectors are available. Even DIN rail products such as Acti9 can be fitted in with an adaptor.

Double socket outlet

Screw IPT terminal

Double socket outlets feature insulated piercing terminals. You don't have to insulate the wires with a tool – just insert them, close the levers, and insulation is done automatically. Disassembling is also easy, and the inserts can be reused.

Flexible cable sizes

Inserts accept 1.5 mm² and 2.5 mm² rigid and flexible cables.

Screws on the back

There's no need to remove the center plate to screw – the center plate is simply clipped in.

Easy installation

The big levers can be opened up to 90° for easy wiring and removing cables.

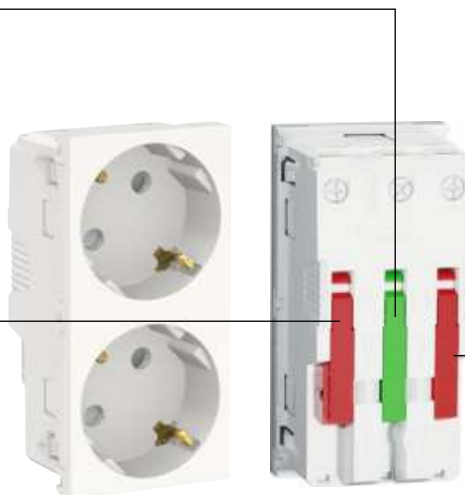

RJ45

Time-saving installation

Unica offers several designs of RJ45 center plates. The double and quadruple versions speed up installation as you only need one device and less space for up to four connectors.

Label holders

A convenient solution to help you identify the connected devices.

Protective shutters

They prevent the ingress of dust and other objects when the port is not in use.

Installation flexibility

The center plates can be used with any S-One Schneider Electric connector.



Clever solutions for flexible fixing

Multifix flush mounting boxes

The perfect way to fit Unica in plasterboard walls.



Multi-gang fixing frame

Adaptable to diverse needs.

The fixing frame can be used both for gang installations and, thanks to the movable dividers, for full window installations. In the latter case, the dividers are moved to the sides to cover wired parts for greater safety.





Standard gang installation



Full window installation

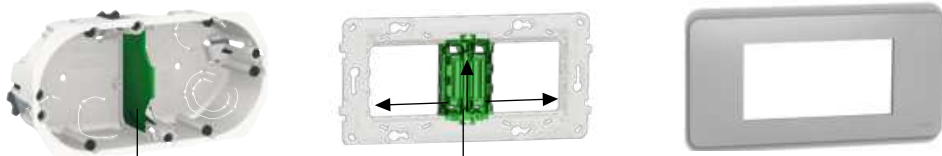

Remove the divider by hand to get a full window.

The dividers can be easily removed from the front or the back and clipped on the sides to keep inserts and wires completely covered for greater safety.



Backward compatibility

Because Unica has long been a popular choice for homes and buildings throughout Europe, it was a priority to make all of the new additions to the range backward compatible to easily integrate with legacy installations where necessary.

How the backward compatibility works

The new Unica inserts are more compact than the old Unica inserts*, so the fixing frame window in the new Unica is smaller. The back part of the new Unica insert is also smaller, but the old and new rockers have the same outer dimension (45x45 mm).



The old Unica fixing frame (44x44 mm)



The new Unica fixing frame (40x40 mm)



The new Unica insert (40x40 mm) and the rocker (45x45 mm)

You can fit new Unica inserts in the old Unica fixing frames with the adaptor.



The old Unica fixing frame (44x44 mm)



The adaptor



The New Unica insert (40x40 mm). The rocker is still 45x45 mm.

The old and new Unica frames are 100% compatible with inserts, fixing frames, and rockers from both the old and the new range.

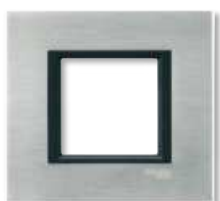

*The old insert cannot be placed in the new fixing frame.

Unica

Inserts

Contents

Switches	68
Specialized controls	72
Comfort devices	74
Sockets	76
USB Chargers	80
Data / Phone / TV	81
Other functions	85
Dedicated trunking applications	87

10 AX – 250 V AC switches

	One-way	One-way with indicator lamp and symbol	Two-way	Two-way with indicator lamp and symbol	Two-way with neutral terminal	Intermediate	Double one-way	Double two-way	IP44
2-module									
<input type="checkbox"/> white	NU320118	–	NU320318 ⁽¹⁾ NU320318F ⁽²⁾ NU320318P ⁽³⁾	–	NU320318S	NU320518	NU321118	NU321318 NU321318F	NU528218
<input type="checkbox"/> aluminium	NU320130	–	NU320330	–	NU320330S	NU320530	NU321130	NU321330	NU528230
<input type="checkbox"/> beige	NU320144	–	NU320344	–	–	NU320544	NU321144	NU321344	NU528244
<input type="checkbox"/> anthracite	NU320154	–	NU320354	–	NU320354S	NU320554	NU321154	NU321354	NU528254
1-module									
<input type="checkbox"/> white	NU310118	NU310118SMUR	NU310318 NU310318F	NU310318SDND	NU310318S	NU310518	–	–	–
<input type="checkbox"/> aluminium	NU310130	–	NU310330	–	NU310330S	NU310530	–	–	–
<input type="checkbox"/> beige	NU310144	–	NU310344	–	–	NU310544	–	–	–
<input type="checkbox"/> anthracite	NU310154	–	NU310354	–	NU310354S	NU310554	–	–	–

Characteristics

- Connection: screwless terminals
- Cables: 1 to 2.5 mm² rigid/flexible

Lighttable with NU9825A, NU9823AM and NU9825AZ LED lamps and rockers with visor











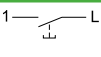
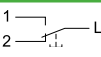
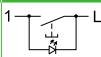

- (1) flow-pack
(2) no individual, flow-pack
(3) pack of 100 in a box

	One-way	Two-way	Intermediate
2-module			
		–	–
<input type="checkbox"/> white	NU320118SC	–	–
<input type="checkbox"/> beige	NU320144SC	–	–
1-module			
<input type="checkbox"/> white	NU310118SC	NU310318SC	NU310518SC
<input type="checkbox"/> beige	NU310144SC	NU310344SC	–

Characteristics



- Connection: screw terminals
- Cables: 1 to 2.5 mm² rigid/flexible
- Lighttable with NU9825A, NU9823AM and NU9825AZ LED lamps and rockers with visor

10 A – 250 V AC push buttons

	NO			NO/NC		NO with locator lamp		
	without symbol	with bell symbol	with light symbol	without symbol	with label holder	without symbol	with bell symbol	with light symbol
								
2-module								
								
<input type="checkbox"/> white	NU320618⁽¹⁾ NU320618F⁽²⁾	NU320618C	NU320618L	NU323618	NU324620	NU320618N⁽¹⁾ NU320618FN⁽²⁾	NU320618CN	NU320618LN
<input type="checkbox"/> aluminium	NU320630	–	–	NU323630	NU324630	NU320630N	NU320630CN	NU320630LN
<input type="checkbox"/> beige	NU320644	–	–	–	–	NU320644N	NU320644CN	–
<input type="checkbox"/> anthracite	NU320654	–	–	NU323654	NU324654	NU320654N	NU320654CN	NU320654LN
1-module								
								
<input type="checkbox"/> white	NU310618⁽¹⁾ NU310618F⁽²⁾	–	–	NU313618	–	NU310618N	NU310618CN	–
<input type="checkbox"/> aluminium	NU310630	–	–	NU313630	–	NU310630N	–	–
<input type="checkbox"/> beige	NU310644	–	–	–	–	–	–	–
<input type="checkbox"/> anthracite	NU310654	–	–	NU313654	–	NU310654N	–	–
Characteristics								
<ul style="list-style-type: none"> • Connection: screwless terminals • Cables: 1 to 2.5 mm² rigid/flexible • Lighttable with NU9825A, NU9823AM and NU9825AZ LED lamps and rockers with visor 								

(1) flow-pack

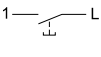
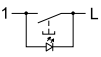
(2) no individual, flow-pack

	NO	NO with locator lamp
	without symbol	without symbol
		
1-module		
		
<input type="checkbox"/> white	NU310618SC	NU310618NSC
<input type="checkbox"/> beige	–	NU310644NSC
Characteristics		
<ul style="list-style-type: none"> • Connection: screw terminals • Cables: 1 to 2.5 mm² rigid/flexible • Lighttable with NU9825A, NU9823AM and NU9825AZ LED lamps and rockers with visor 		

16 AX – 250 V AC switches



	One-way	One-way with indicator lamp	Two-way	2 poles	2 poles with indicator lamp	3 poles
2-module						
<input type="checkbox"/> white	NU326118	NU326118N	NU326318	NU326218	NU326218S	NU328118
<input type="checkbox"/> aluminium	–	–	NU326330	NU326230	NU326230S	–
<input type="checkbox"/> beige	NU326144	–	–	–	–	–
<input type="checkbox"/> anthracite	–	–	NU326354	NU326254	NU326254S	–
1-module						
<input type="checkbox"/> white	NU316118	NU316118S	NU316318	NU316218	NU316218S	–
<input type="checkbox"/> aluminium	NU316130	–	–	–	–	–
<input type="checkbox"/> beige	NU316144	–	–	–	–	–
<input type="checkbox"/> anthracite	NU316154	–	NU316354	–	–	–
Characteristics						
<ul style="list-style-type: none"> • Connection: screw terminals • Cables: 1 to 2.5 mm² rigid/flexible • Lighttable with NU9825A, NU9823AM and NU9825AZ LED lamps and rockers with visor 		<ul style="list-style-type: none"> • Connection: screw terminals • Cables: 1 to 4 mm² rigid/f 		<ul style="list-style-type: none"> • Connection: screw terminals • Cables: 1 to 2.5 mm² rigid/flexible • Lighttable with NU9825A, NU9823AM and NU9825AZ LED lamps and rockers with visor 		

High rating switches

	20 A 2 poles	30 A 2 poles with indicator lamp
2-module		
<input type="checkbox"/> white	NU322518	NU323218S
<input type="checkbox"/> aluminium	–	NU323230S
<input type="checkbox"/> beige	–	NU323244S
<input type="checkbox"/> anthracite	–	NU323254S
Characteristics		
<ul style="list-style-type: none"> • Connection: screw terminals • Cables: up to 4 mm² rigid/flexible 		<ul style="list-style-type: none"> • Connection: screw terminals • Cables: up to 6 mm² rigid/flexible

Unica Inserts Switches

Accessories – Lamps

LED lamps	12-24 V DC	250 V AC	
	White	Red	White
			
	NU9823AM	NU9825A	NU9825AZ
Characteristics			
Consumption	0.15 mA	1,5 mA	0,05 mA

Spring to transform a switch to push button







S520299

Characteristics

10 units delivered with a positioning aid tool

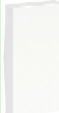
Accessories – Rockers

Rockers	without symbol	with visor
2-module		
		
<input type="checkbox"/> white	NU920018	NU920018N
<input type="checkbox"/> aluminium	NU920030	NU920030N
<input type="checkbox"/> beige	NU920044	–
<input type="checkbox"/> anthracite	NU920054	NU920054N
1-module		
		
<input type="checkbox"/> white	NU910018	NU910018N
<input type="checkbox"/> aluminium	NU910030	NU910030N
<input type="checkbox"/> beige	NU910044	–
<input type="checkbox"/> anthracite	NU910054	NU910054N

Unica

Inserts

Specialized controls

Fan controls

Two-way ON/OFF – 10 A	
2-module	
	
<input type="checkbox"/> white	NU321418
<input type="checkbox"/> aluminium	NU321430
<input type="checkbox"/> anthracite	NU321454

Shutter controls

10 A	Push button	Switch	2 poles	
			Push button	Switch
1-module				
				
<input type="checkbox"/> white	NU310718SC	NU310818SC	NU312718SC	NU310918SC
<input type="checkbox"/> aluminium	NU310730SC	NU310830SC	–	–
<input type="checkbox"/> beige	NU310744SC	NU310844SC	NU312744SC	NU310944SC
<input type="checkbox"/> anthracite	NU310754SC	NU310854SC	–	–
Characteristics				
<ul style="list-style-type: none"> • Connection: screw terminals • Cables: 1 to 2.5 mm² rigid/flexible 				

	Push button		Switch
	6 A	10 A	6 A
2-module			
			
<input type="checkbox"/> white	NU320718	NU323718	NU320818
<input type="checkbox"/> aluminium	NU320730	NU323730	NU320830
<input type="checkbox"/> beige	NU320744	–	NU320844
<input type="checkbox"/> anthracite	NU320754	NU323754	NU320854
Characteristics			
<ul style="list-style-type: none"> • Connection: screwless terminals • Cables: 1 to 2.5 mm² rigid/flexible 			

Cord push buttons

NO/NC – 10 A	
2-module	
	
<input type="checkbox"/> white	NU322620
<input type="checkbox"/> aluminium	NU322630
<input type="checkbox"/> beige	NU322644
<input type="checkbox"/> anthracite	NU322654
Characteristics	
<ul style="list-style-type: none"> • Connection: screwless terminals • Cables: 1 to 2.5 mm² rigid/flexible 	

Key switches

	Push button – 16 A	Switch – 16 A
2-module		
		
<input type="checkbox"/> white	NU373118	NU370118
<input type="checkbox"/> aluminium	NU373130	–
<input type="checkbox"/> anthracite	NU373154	–
Characteristics		
3 positions		

Unica

Inserts

Specialized controls

Card push buttons

	NO/NC – 10 A
2-module	
	
<input type="checkbox"/> white	NU328318
<input type="checkbox"/> aluminium	NU328330
<input type="checkbox"/> beige	NU328344
<input type="checkbox"/> anthracite	NU328354

Emergency stop







	Key switch – 10 A	Mushroom – 10 A
2-module		
 		
<input type="checkbox"/> yellow	ALB45032	ALB45033

Unica

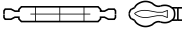
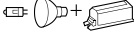
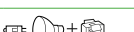

Inserts

Comfort devices

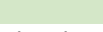
Dimmers

	Universal	Compensation module LED
2-module		
		
<input type="checkbox"/> white	NU351418	-
<input type="checkbox"/> aluminium	NU351430	-
<input type="checkbox"/> anthracite	NU351454	-
Load compensation module		
	-	CCT90501
Maximum loads		
LED lamp 230 V 	RC: 5...100 VA RL: 5...20 VA	
incandescent lamp 230 V 	5...200 W	
halogen lamp 230 V 	5...150 W	
LV halogen lamps 12 V  electronic transformer 	5...150 VA	
 wound transformer 	5...150 VA	
Characteristics		
<ul style="list-style-type: none"> • Remote control by unlimited number of auxiliary push-button • Automatic load detection • Wire configuration without neutral • Screw terminals connection • Memory function • Automatic overload protection, overheating protection, short-circuit protection 		<ul style="list-style-type: none"> • Rated voltage: 230 V AC • Frequency range: 50 - 60 Hz • Power loss: 2 W max. • Installation: junction box, in the luminaire or in the sub-distribution panel, wired between neutral and dimmed phase.

Thermostats







	Room – 8 A	Floor – 10 A
2-module		
		
<input type="checkbox"/> white	NU350118	NU350318
<input type="checkbox"/> aluminium	NU350130	NU350330
<input type="checkbox"/> beige	NU350144	NU350344
<input type="checkbox"/> anthracite	NU350154	NU350354
Characteristics		
	<ul style="list-style-type: none"> • For heating or air-conditioning • Settings range: + 5 to + 30 °C • Blue and red LED's for conditioning or heating indication 	<ul style="list-style-type: none"> • For floor heating • Settings range: + 5 to + 45 °C • Green LED for voltage supply indication • Red LED for heating indication • Delivered with a 4 m temperature sensor

Unica

Inserts

Comfort devices

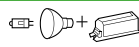
Motion sensors

10 A		
2-module		
		
<input type="checkbox"/> white	NU352518	
<input type="checkbox"/> aluminium	NU352530	
<input type="checkbox"/> anthracite	NU352554	
Maximum loads		
LED lamp 230 V	 200 W	
incandescent lamp 230 V	 2200 W	
halogen lamp 230 V	 2000 W	
motor (single-phase) 230 V	 1000 VA	
LV halogen lamps 12 V	electronic transformer 	1050 VA
	wound transformer 	500 VA
Characteristics		
<ul style="list-style-type: none"> • Screw terminals connection • Wire configuration with neutral • Detection angle: 160 ° • Movement detection area: 8 m frontal, 8 m lateral • Remote control by unlimited number of auxiliary push-button • Automatic load detection • Built-in on/off push-button switch • Time delay range: 1...30 min • Master/slave option; two sensors can be connected together to cover larger area 		

Timers



Countdown timer relay – 10 A	
2-module	
	
<input type="checkbox"/> white	NU353518
<input type="checkbox"/> aluminium	NU353530
<input type="checkbox"/> anthracite	NU353554
Characteristics	
<ul style="list-style-type: none"> • Time delay range: 5 min to 8 h • Integrated status LED • 3-wires (neutral required) 	

Electronic card switch

8 A	
	
<input type="checkbox"/> white	NU354018
<input type="checkbox"/> anthracite	NU354054
Characteristics	
<ul style="list-style-type: none"> • 8 A • Timed 10 seconds 	

Side Earth sockets

90°	With shutters screwless	With shutters screw	Without shutters screw	With lid & shutters screw	IP44 frame with shutters	IP44 with shutters	Single socket+USB
2-module							
							
□ white	NU305718	NU303718	NU303618	NU303718TA	NU003718	NU508218	NU301718
□ aluminium	NU305730	NU303730	-	NU303730TA	-	NU508230	NU301730
□ beige	NU305744	NU303744	NU303644	NU303744TA	NU003744	NU508244	NU301744
■ anthracite	NU305754	NU303754	-	NU303754TA	-	NU508254	NU301754
■ orange	-	NU303761	-	-	-	-	-
■ red	NU305703	NU303703	-	-	-	-	-
■ green	-	NU303706	-	-	-	-	-
Characteristics							
2P+E - 16 A - 250 V						<ul style="list-style-type: none"> • Screwless terminals • 2P+E - 16 A - 250 V • Shuttered 	<ul style="list-style-type: none"> • 2P+E - 16 A - 250 V • Screwless terminals • Output power USB: 5 V

45°	Standard		With lamp
4-module	Screwless	Screw *	Screw *
			
□ white	NU306618	NU306718A NU306718⁽¹⁾	NU306718AS NU306718S
□ aluminium	NU306630	NU306730A	NU306730AS
■ anthracite	NU306654	NU306754A	NU306754AS
■ red	NU306603	NU306703A NU306703⁽¹⁾	NU306703AS NU306703S⁽¹⁾
■ green	-	-	NU306706AS
■ orange	-	-	NU306761AS
Characteristics			
<ul style="list-style-type: none"> • 2P+E - 16 A - 250 V • * for Screw devices - Screw-IPT terminals (except (1): screw terminals in one side) • With shutters 			

45°	Standard
6-module	Screwless
	
□ white	NU307618
□ aluminium	NU307630
■ red	NU307603
Characteristics	
<ul style="list-style-type: none"> • 2P+E - 16 A - 250 V • With shutters 	

	Double Socket
	
□ white	NU206718
□ aluminium	NU206730
□ beige	NU206744
■ anthracite	NU206754
Characteristics	
<ul style="list-style-type: none"> • Screw terminals • 2P+E - 16 A - 250 V 	

Pin Earth sockets

90°	Standard screwless	Standard screw	Surface screwless	Tamperproof screw	Sockets with surge protection	Single socket+USB
2-module						
<input type="checkbox"/> white	NU305918 NU305918E ⁽¹⁾ NU305918P ⁽²⁾	NU303918 NU303918E ⁽¹⁾	NU305218 NU305218E ⁽¹⁾ NU305218P ⁽²⁾	NU305118	NU305918EP	NU301518 NU301518E ⁽¹⁾
<input type="checkbox"/> aluminium	NU305930 NU305930E ⁽¹⁾	NU303930 NU303930E ⁽¹⁾	NU305230 NU305230E ⁽¹⁾	-	NU305930EP	NU301530 NU301530E ⁽¹⁾
<input type="checkbox"/> beige	NU305944E ⁽¹⁾	NU303944E ⁽¹⁾	NU305244E ⁽¹⁾	-	-	-
<input type="checkbox"/> anthracite	NU305954 NU305954E ⁽¹⁾	NU303954 NU303954E ⁽¹⁾	NU305254 NU305254E ⁽¹⁾	-	NU305954EP	NU301554 NU301554E ⁽¹⁾
<input type="checkbox"/> red	NU305903	NU303903E ⁽¹⁾	NU305203	NU305103	-	-
<input type="checkbox"/> green	NU305906	-	NU305206	-	-	-
<input type="checkbox"/> orange	NU305961	-	-	-	-	-
Characteristics						
<ul style="list-style-type: none"> • 2P+E - 16 A - 250 V • With shutters 					<ul style="list-style-type: none"> • 2P+E - 16 A - 250 V • Screwless terminals • Output power USB: 5 V 	



(1) For Czech Republic, Slovakia and Spain

(2) Pack of 100



45°	Standard			With lamp	Tamperproof		Tamperproof with lamp
	2-module	4-module	6-module	4-module	4-module	6-module	4-module
<input type="checkbox"/> white	NU304918	NU306918	NU307918	NU306918S	-	-	-
<input type="checkbox"/> aluminium	-	NU306930	NU307930	-	-	-	-
<input type="checkbox"/> anthracite	NU304954	NU306954	NU307954	NU306954S	-	-	-
<input type="checkbox"/> red	NU304903	NU306903	NU307903	NU306903S NU306903SE	NU306103	NU307103	NU306103S
<input type="checkbox"/> green	NU304906	NU306906	NU307906	-	-	-	-
Characteristics							
<ul style="list-style-type: none"> • 2P+E - 16 A - 250 V • Screwless terminals • With shutters 							

(1) For Czech Republic, Slovakia and Spain



Pin Earth double sockets

	Double with cover frame	Double socket
		
<input type="checkbox"/> white	NU406918	NU206518
<input type="checkbox"/> aluminium	–	NU206530
<input type="checkbox"/> beige	–	NU206544
<input type="checkbox"/> anthracite	NU406954	NU206554
Characteristics		
<ul style="list-style-type: none"> • 2P - 16 A - 250 V • Screw terminals • With shutters • Installation in 1-gang box 		<ul style="list-style-type: none"> • 2P - 16 A - 250 V • Screw terminals • Installation in 1-gang box



European sockets

	Simple	16 A	10 A	Double
		2-module	1-module	
				
<input type="checkbox"/> white		NU303318	NU303118	NU206318
<input type="checkbox"/> aluminium		–	NU303130	–
<input type="checkbox"/> beige		NU303344	NU303144	–
<input type="checkbox"/> anthracite		NU303354	NU303154	–
Characteristics				
		<ul style="list-style-type: none"> • 2P - 250 V • Screw terminals 	<ul style="list-style-type: none"> • 2P - 16 A - 250 V • Screw terminals • Installation in 1-gang box 	
*A residual current circuit protection with a sensitivity of 30 mA must be installed for this product.				

Euroamerican sockets

		Shuttered	
	1-module	1-module	2-module
			
<input type="checkbox"/> white	NU302018	NU302118	NU304118
<input type="checkbox"/> aluminium	–	NU302130	NU304130
<input type="checkbox"/> beige	NU302044	NU302144	–
<input type="checkbox"/> anthracite	–	NU302154	NU304154
Characteristics			
<ul style="list-style-type: none"> • 16 A - 250 V AC for cylindrical pins • 15 A - 125 V AC for flat pins • Screw terminals 			
*A residual current circuit protection with a sensitivity of 30 mA must be installed for this product.			

American sockets

15 A	Single	Double
	2-module	3 module
		
<input type="checkbox"/> white	NU302818	NU306018
<input type="checkbox"/> aluminium	NU302830	NU306030
<input type="checkbox"/> anthracite	NU302854	NU306054
Characteristics		
<ul style="list-style-type: none"> • 2P+E - 15 A • Screw terminals • Shuttered 		

Italian sockets



16 A	
	1-module
	
<input type="checkbox"/> white	NU302318
<input type="checkbox"/> aluminium	NU302330
<input type="checkbox"/> beige	NU302344
<input type="checkbox"/> anthracite	NU302354
Characteristics	
<ul style="list-style-type: none"> • 2P+E - 16 A • Screw terminals • Shuttered 	

British sockets



13 A	
	2-module
	
<input type="checkbox"/> white	NU304518
<input type="checkbox"/> aluminium	NU304530
<input type="checkbox"/> beige	NU304544
<input type="checkbox"/> anthracite	NU304554
Characteristics	
<ul style="list-style-type: none"> • 2P+E - 13 A • Screw terminals • Shuttered 	

Unica Inserts Sockets

Danish sockets

90°	Single	Double
	2-module	4-module
		
<input type="checkbox"/> white	NU308818	NU309818
<input type="checkbox"/> aluminium	-	NU309830
Characteristics		
<ul style="list-style-type: none"> • 2P+E - 16 A - 250 V • EDB (Elektronisk Data Behandling) for electronic data processing 		

Multistandard sockets

	2-module	3-module
		
<input type="checkbox"/> white	NU308418	NU308518
<input type="checkbox"/> aluminium	NU308430	-
<input type="checkbox"/> anthracite	NU308454	-
Characteristics		
<ul style="list-style-type: none"> • Screw terminals • Shuttered 		
*A residual current circuit protection with a sensitivity of 30 mA must be installed for this product.		

Israel sockets



	2-module
	
<input type="checkbox"/> white	NU304718
<input type="checkbox"/> aluminium	NU304730
<input type="checkbox"/> beige	NU304744
<input type="checkbox"/> anthracite	NU304754
<input type="checkbox"/> red	NU304703
Characteristics	
<ul style="list-style-type: none"> • 2P+E - 16 A • Screw terminals • Shuttered 	

Shaver sockets

	20 VA
	
<input type="checkbox"/> white	MGU5.064.18
Characteristics	
<ul style="list-style-type: none"> • 3-module • Input: 240 V • Output: 115/240 V 	

Accessories

Jumper for Side and Pin Earth sockets-outlets	Tamperproof accessory
	
NU9091	ALB45290
Characteristics	
Set of 10 jumpers for multiple Side and Pin Earth screwless sockets-outlets	









Centres plates for Side Earth Sockets	
2-module	
	
<input type="checkbox"/> beige	NU903744
For Unica MGU●●●●●●	
2-module	
	
<input type="checkbox"/> white	NU903718U

Unica

Inserts

USB Chargers

USB chargers

	Chargers type A	Chargers type A+C				Charger type C	
2-module							
							
<input type="checkbox"/> white	NU341818	NU301818	NU301918	NU501318	NU501418	NU301518 NU301518E	NU301718
<input type="checkbox"/> aluminium	NU341830	NU301830	NU301930	NU501330	NU501430	NU301530 NU301530E	NU301730
<input type="checkbox"/> beige	NU341844	-	-	NU501344	NU501444	-	NU301744
<input checked="" type="checkbox"/> anthracite	NU341854	NU301854	NU301954	NU501354	NU501454	NU301554 NU301554E	NU301754
1-module							
							
<input type="checkbox"/> white	-	NU301618	-	-	-	-	-
<input type="checkbox"/> aluminium	-	NU301630	-	-	-	-	-
<input type="checkbox"/> beige	-	NU301644	-	-	-	-	-
<input checked="" type="checkbox"/> anthracite	-	NU301654	-	-	-	-	-
Characteristics							
	<ul style="list-style-type: none"> • NU3418●● Output power: 5 V DC - max 2.1 A • NU3428●● Output power: 5 V DC - 1 A 	<ul style="list-style-type: none"> • NU3018●● output power: 5 V DC - max 2.4 A • NU3016●● Output power: 12 W 5V DC - 2.4 Max each port 	Output power: 18W 5V DC - 2.4 Max each port	Output power: Type C 45W + Type A 7.5W	Output power: 65W	<ul style="list-style-type: none"> • 2P+E - 16 A - 250 V • Screwless terminals • Output power USB: 5 V • Output power: 10.5 W 	

Inserts

Data / Phone / TV

RJ45 data sockets

	Cat. 5e UTP	Cat. 5e STP	Cat. 6 UTP	Cat. 6 STP		Cat. 6 FTP	Cat. 6A UTP	Cat. 6A FTP
	straight	straight	straight	straight	inclined	straight	straight	straight
2-module								
□ white	NU341118	NU341318	NU341518	NU341718	–	NU341918 NU341918P⁽¹⁾	–	NU344918
■ aluminium	NU341130	–	NU341530	NU341730	–	NU341930	–	NU344930
■ beige	NU341144	–	NU341544	–	–	–	–	–
■ anthracite	NU341154	–	NU341554	NU341754	–	NU341954	–	NU344954
□ white	NU342018	–	–	NU342618	–	–	–	–
■ aluminium	NU342030	–	–	NU342630	–	–	–	–
■ anthracite	NU342054	–	–	NU342654	–	–	–	–
1-module								
□ white	NU341018	NU341218	NU341418	NU341618	NU340618	NU344718	–	NU344818
■ aluminium	NU341030	–	NU341430	NU341630	–	–	–	NU344830
■ beige	NU341044	–	NU341444	NU341644	–	–	–	NU344844
■ anthracite	NU341054	–	NU341454	NU341654	–	NU344754	–	NU344854
4-module								
□ white	–	–	NU348218	–	–	–	NU348418	–
□ white	NU347918	–	–	–	–	–	NU348518	–

Characteristics

- Connector Actassi S-One
- Straight : with shutter and label space
- Inclined : with label space

(1) pack of 100

Inserts

Data / Phone / TV

RJ45 centre plates

	For S-One RJ45 connector		For Keystone/Systimax RJ45 connector	
	straight	inclined	straight	inclined
2-module				
□ white	NU941118	NU940718	NU946118	NU946418
■ aluminium	NU941130	-	NU946130	-
■ anthracite	NU941154	NU940754	NU946154	NU946454
□ white	NU942218*	NU942418*	-	-
■ anthracite	NU942254*	-	-	-
□ white	NU942018	-	-	-
■ anthracite	NU942054	-	-	-
1-module				
□ white	NU941018	NU940618	NU946018	-
■ aluminium	-	-	NU946030	-
■ anthracite	NU941054	NU940654	NU946054	-
4-module				
□ white	NU947818	-	NU946218	-
■ aluminium	NU947830	-	NU946230	-
■ anthracite	-	-	NU946254	-
□ white	NU947918	-	NU946318	-
■ aluminium	NU947930	-	NU946330	-
■ anthracite	-	-	NU946354	-

Characteristics

- Straight: with shutter and label space
- Inclined: with label space
- Type: SLIM, except * DPM
- * Type: DPM

Optical fibre centre plates

	SC/SC APC Simplex	SC/SC APC duplex
2-module		
□ white	NU943918	NU943818
■ anthracite	NU943954	NU943854





Characteristics

- Support to receive any SC simplex and duplex adapters
- Support to receive Actassy optical fibre adapters:
 - SC Duplex multi mode adapters: ref. n° VDIB6031001 and VDIB6031002
 - SC Duplex single mode adapters: ref. n° VDIB6032001 and VDIB6032002
 - SC APC Duplex single mode adapter: ref. n° VDIB6082001
 - SC APC Simplex single mode adapter: ref. n° VDIB6072001.





Inserts

Data / Phone / TV

Telephone sockets

	RJ12 connector	French standard phone jack	British telephone socket
2-module			
			
<input type="checkbox"/> white	NU349718	NU349618	-
<input type="checkbox"/> aluminium	NU349730	-	-
<input type="checkbox"/> beige	NU349744	-	-
<input type="checkbox"/> anthracite	-	NU349654	-
1-module			
			
<input type="checkbox"/> white	NU349118	-	NU349918
<input type="checkbox"/> aluminium	NU349130	-	NU349930
<input type="checkbox"/> beige	NU349144	-	NU349944
<input type="checkbox"/> anthracite	NU349154	-	NU349954







Multimedia sockets

	VGA	Mini Jack	HDMI	RCA	Data Sockets
1-module					
					
<input type="checkbox"/> white	NU343218	NU343318	NU343018	NU343118	NU342918
<input type="checkbox"/> aluminium	-	NU343330	NU343030	-	NU342930
<input type="checkbox"/> beige	-	-	NU343044	-	-
<input type="checkbox"/> anthracite	NU343254	NU343354	NU343054	NU343154	NU342954
Characteristics					USB 2.0

Inserts



Data / Phone / TV

TV sockets

	TV		TV/FM			R-TV/SAT			FM/TV/SAT
	male, individual	female, individual	individual	intermediate	terminal	individual	intermediate	terminal	individual (1 cable)
2-module									
									
<input type="checkbox"/> white	NU346218	–	NU345118	NU345318	NU345218	NU345418	NU345618	NU345518	NU345018
<input type="checkbox"/> aluminium	NU346230	–	NU345130	–	NU345230	NU345430	–	–	NU345030
<input type="checkbox"/> beige	NU346244	–	NU345144	–	–	NU345444	–	–	NU345044
<input type="checkbox"/> anthracite	NU346254	–	NU345154	–	NU345254	NU345454	–	NU345554	NU345054
1-module									
									
<input type="checkbox"/> white	NU346118	NU346818	–	–	–	–	–	–	–
<input type="checkbox"/> aluminium	NU346130	NU346830	–	–	–	–	–	–	–
<input type="checkbox"/> beige	–	NU346844	–	–	–	–	–	–	–
<input type="checkbox"/> anthracite	NU346154	NU346854	–	–	–	–	–	–	–

	M-S
2-module	
	
<input type="checkbox"/> white	NU545718
<input type="checkbox"/> anthracite	NU545754

TV centre plates





	TV/FM	R-TV/SAT
2-module		
		
<input type="checkbox"/> white	NU944018	NU944118
<input type="checkbox"/> aluminium	–	NU944130
<input type="checkbox"/> anthracite	NU944054	NU944154

Unica





Inserts

Other functions

Sound inserts

Loudspeakers connectors		Loudspeakers (for Bluetooth)	In-wall Bluetooth receiver	Volume control	
	2-module	1-module			
					
<input type="checkbox"/> white	NU348618	NU348718	–	NU360118	NU360218
<input type="checkbox"/> aluminium	NU348630	NU348730	–	–	NU360230
<input type="checkbox"/> beige	NU348644	NU348744	–	–	–
<input type="checkbox"/> anthracite	NU348654	NU348754	–	NU360154	NU360254
		NU3488	–		
Characteristics		<ul style="list-style-type: none"> • 2 loudspeakers delivered with 2 cables (5 m, Φ 0.5 mm², red and white) • Impedance: 8 Ω 		<ul style="list-style-type: none"> • Audio receiver <ul style="list-style-type: none"> - 2-module - voltage: 15-16 V DC • Power supply <ul style="list-style-type: none"> - voltage: 93-265 V AC - frequency: 47-63 Hz Delivered with: <ul style="list-style-type: none"> • audio receiver device • power supply 	

Light signaling



Signaling light	
12-24 V DC	230 V AC
2-module	
	
NU3773	NU3772
1-module	
	
NU3774	NU3775
Delivered with green and red papers to include under the centre plate.	

Emergency light

2-module

NU3776
Characteristics
<ul style="list-style-type: none"> • 45 lux / 25 cm • Integrated battery • 230 V AC

Sound signaling

	Buzzer	Electronic doorbell
2-module		
		
<input type="checkbox"/> white	NU378518	NU378618
<input type="checkbox"/> aluminium	NU378530	NU378630
<input type="checkbox"/> beige	NU378544	NU378644
<input type="checkbox"/> anthracite	NU378554	NU378654
Characteristics		
230 V AC, 50/60 Hz		
Acoustic level: adjustable from 76 to 80 dB/1 m		<ul style="list-style-type: none"> • Acoustic level: 70 dB/1m • 5 melodies • Maximum connected in parallel to the output: <ul style="list-style-type: none"> - 10 without lamp - or 3 with lamp

Unica

Inserts

Other functions

WiFi repeater

WiFi repeater	
2-module	
	
<input type="checkbox"/> white	NU360518
Characteristics	
<ul style="list-style-type: none"> • Repeats the WiFi signal received from the Internet box to extend its receiving coverage in housing • Time programming to define ranges for signal on and signal off • Signal coverage: 15 m (indoor) • Data speed: max 300 Mbps • Communication standard: WiFi 802.11 b/g/n 2.4 GHz • 100-240 V AC - 50/60 Hz • Pairing mode: WPS (pairing method also featured on most routers) and through HTML pages 	

Bed side lamp

Lamp+USB charger type A	
	
<input type="checkbox"/> white	NU360318
<input type="checkbox"/> aluminium	NU360330
<input type="checkbox"/> beige	NU360344
<input type="checkbox"/> anthracite	NU360354
Characteristics	
<ul style="list-style-type: none"> • Lamp 2 W • USB 5 V DC - max 2.1 A 	



Cable Outlets

16 A	
2-module	
	
<input type="checkbox"/> white	NU386218
<input type="checkbox"/> aluminium	NU386230
<input type="checkbox"/> beige	NU386244
<input type="checkbox"/> anthracite	NU386254
Characteristics	
cable diameter: from 6 to 12 mm	

Protection

16 A		Fuse holder
1-module		
		
<input type="checkbox"/> white	NU363118	

Blind covers

Blind covers			
	2-module	1-module	1/2 module (2 x)
			
<input type="checkbox"/> white	NU986618	NU986518	NU986418
<input type="checkbox"/> aluminium	NU986630	NU986530	NU986430
<input type="checkbox"/> beige	NU986644	NU986544	NU986444
<input type="checkbox"/> anthracite	NU986654	NU986554	NU986454

Inserts

Dedicated trunking applications

Sockets

	90°	45°			Surface	Tamperproof		
	2-module	2-module	4-module	6-module	2-module	2-module	4-module	6-module
<input type="checkbox"/> white	NU305920T	NU304918T	NU306918T	NU307918T	NU305218T	-	-	-
<input checked="" type="checkbox"/> red	NU305903T	NU304903T	NU306903T	NU307903T	NU305203T	NU305103T	NU306103T	NU307103T

Characteristics

- 2P+E - 16 A - 250 V
- With shutters
- Screwless terminals (except NU305103T)

RJ45 centre plates

	For S-One RJ45 connector straight
2-module	
<input type="checkbox"/> white	NU941118T
Characteristics	
With shutter and label space	

Unica Inserts with Fixing Frame

Contents

Switches	90
Specialized controls	92
Comfort devices	93
Sockets	94
USB chargers	95
Data / Phone / TV	96
Other functions	97

Inserts with fixing frame

Switches

10 AX – 250 V AC switches

	Standard			With locator lamp			IP44
	one-way	two-way	intermediate	one-way	two-way	intermediate	
2-module							
<input type="checkbox"/> white	NU520118	NU520318	NU520518	NU520118N	-	NU520518N	NU528218
<input type="checkbox"/> aluminium	-	-	-	-	-	-	NU528230
<input type="checkbox"/> beige	NU520144	NU520344	-	-	-	-	NU528244
<input type="checkbox"/> anthracite	NU520154	NU520354	NU520554	NU520154N	NU520354N	-	NU528254
2 x 1-module							
<input type="checkbox"/> white	NU521118	NU521318	NU521518	NU521118N	-	-	-
<input type="checkbox"/> aluminium	NU521130	NU521330	NU521530	NU521130N	-	-	-
<input type="checkbox"/> beige	NU521144	NU521344	NU521544	-	-	-	-
<input type="checkbox"/> anthracite	NU521154	NU521354	NU521554	NU521154N	-	-	-
Characteristics							
<ul style="list-style-type: none"> • Connection: screwless terminals • Cables: 1 to 2.5 mm² rigid/flexible 						<ul style="list-style-type: none"> • Screwless terminals • Cables: 1 to 2.5 mm² rigid/flexible 	

10 AX – 250 V AC switches

	Control unit
2-module	
<input type="checkbox"/> white	NU521718
<input type="checkbox"/> aluminium	NU521730
<input type="checkbox"/> anthracite	NU521754



10 A – 250 V AC push buttons

	NO
2-module	
<input type="checkbox"/> white	NU520618
Characteristics	
<ul style="list-style-type: none"> • Connection: screwless terminals • Cables: 1 to 2.5 mm² rigid/flexible • Lightable with NU9825A, NU9823AM and NU9825AZ LED lamps and rockers with visor 	

Inserts with fixing frame

Switches

Accessories – Lamps

LED lamps	12-24 V DC	250 V AC	
	white	red	white
			
	NU9823AM	NU9825A	NU9825AZ
Characteristics			
Consumption	0.15 mA	1.5 mA	0.05 mA

Spring to transform a switch to push button







S520299

Characteristics

10 units delivered with a positioning aid tool



Accessories – Rockers

Rockers	without symbol	with visor
2-module		
		
<input type="checkbox"/> white	NU920018	NU920018N
<input type="checkbox"/> aluminium	NU920030	NU920030N
<input type="checkbox"/> beige	NU920044	–
<input type="checkbox"/> anthracite	NU920054	NU920054N
1-module		
		
<input type="checkbox"/> white	NU910018	NU910018N
<input type="checkbox"/> aluminium	NU910030	NU910030N
<input type="checkbox"/> beige	NU910044	–
<input type="checkbox"/> anthracite	NU910054	NU910054N

Inserts with fixing frame

Specialized controls





Shutters control

	Push button – 6 A	Switch – 6 A
2-module		
<input type="checkbox"/> white	NU520718	NU520818
<input checked="" type="checkbox"/> anthracite	NU520754	-

Inserts with fixing frame

Comfort devices

Dimmers

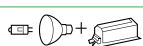
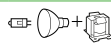
Universal		Compensation module LED	
2-module			
			
■ beige	NU551444	-	
■ anthracite	NU551454	-	
Load compensation module		-	CCT90501
Maximum loads			
LED lamp 230 V		RC: 5...100 VA RL: 5...20 VA	
incandescent lamp 230 V		5...200 W	
halogen lamp 230 V		5...150 W	
LV electronic halogen lamps 12 V		5...150 VA	
wound transformer		5...150 VA	
Characteristics			
<ul style="list-style-type: none"> • Remote control by unlimited number of auxiliary push button • Automatic load detection • Wire configuration without neutral • Screw terminal connection • Memory function • Automatic overload protection, overheating protection, short-circuit protection 		<ul style="list-style-type: none"> • Rated voltage: 230 VAC • Frequency range: 50 - 60 Hz • Power loss: 2 W max • Installation: junction box, in the luminaire or in the sub-distribution panel, wired between neutral and dimmed phase. 	

Thermostats

	Room – 8 A	Floor – 10 A
2-module		
		
□ white	NU550118	NU550318
■ aluminium	-	NU550330
■ beige	-	NU550344
■ anthracite	-	NU550354
Characteristics		
	<ul style="list-style-type: none"> • For heating and air-conditioning • Settings range: + 5 to + 30 °C • Blue and red LED's for conditioning or heating indication 	<ul style="list-style-type: none"> • For floor heating • Settings range: + 5 to + 45 °C • Green LED for voltage supply indication • Red LED for heating indication • Delivered with a 4 m temperature sensor

Inserts with fixing frame Sockets

Side Earth sockets

	With shutters			Without shutters	
	screwless terminal	screw terminal	with lid	screwless terminal	screw terminal
2-module					
□ white	NU505718	NU503718	NU503718TA	NU505618	NU503618
■ aluminium	NU505730	NU503730	NU503730TA	NU505630	NU503630
■ beige	NU505744	-	NU503744TA	NU505644	NU503644
■ anthracite	NU505754	NU503754	NU503754TA	NU505654	NU503654
Characteristics					
● 2P+E - 16 A - 250 V					

	With cover frame	
	simple	double
□ white	NU203718	NU206718
■ aluminium	-	NU206730
■ beige	-	NU206744
■ anthracite	-	NU206754
Characteristics		
● Screw terminal		
● Installation in 1-gang box		

90°	IP44 frame
2-module	
□ white	NU508218
■ aluminium	NU508230
■ beige	NU508244
■ anthracite	NU508254
Characteristics	
- 2P+E - 16 A - 250 V	
- Screwless terminals	
- Shuttered	

Centres plates for Side Earth Sockets	
2-module	
■ beige	NU903744
For Unica MGU●●●●●●	
2-module	
□ white	NU903718U

European sockets





Simple	16 A
2-module	
□ white	NU503318
■ aluminium	NU503330
■ beige	NU503344
■ anthracite	NU503354
Characteristics	
● 2P - 250 V	
● Screw terminal	
Double	with cover frame
□ white	NU206318
Characteristics	
● 2P - 16 A - 250 V	
● Screw terminal	
● Installation in 1-gang box	

Shaver sockets

20 VA	
□ white	MGU5.064.18
Characteristics	
● 3-module	
● Input: 240 V	
● Output: 115/240 V	

Inserts with fixing frame USB chargers





USB chargers

	Charger type A	Charger type A+C		Charger type C
2-module				
<input type="checkbox"/> white	NU541818	NU501818	NU501318	NU501418
<input type="checkbox"/> aluminium	–	NU501830	NU501330	NU501430
<input type="checkbox"/> beige	–	NU501844	NU501344	NU501444
<input type="checkbox"/> anthracite	NU541854	NU501854	NU501354	NU501454
Characteristics				
	USB 2.0			
	<ul style="list-style-type: none"> • Output power: <ul style="list-style-type: none"> - NU5418●●: 5 V DC - 1.1 A + 2 A 	<ul style="list-style-type: none"> • Output power: <ul style="list-style-type: none"> - NU5018●●: 5 V DC - 1.2 A + 2.4 A 	<ul style="list-style-type: none"> Output power: <ul style="list-style-type: none"> Type C 45W + Type A 7.5W 	<ul style="list-style-type: none"> Output power: 65 W

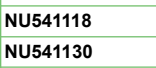

Inserts with fixing frame

Data / Phone / TV

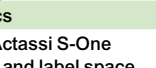
RJ45 data sockets

RJ45	Cat. 5e UTP zamak fixing frame	Cat. 6 UTP zamak fixing frame
2-module		
		
<input type="checkbox"/> white	NU541118	NU541518
<input type="checkbox"/> aluminium	NU541130	NU541530
<input type="checkbox"/> beige	NU541144	NU541544
<input type="checkbox"/> anthracite	NU541154	NU541554
2 x 1-module		
		
<input type="checkbox"/> white	NU542018	NU542418
<input type="checkbox"/> anthracite	NU542054	NU542454
Characteristics		
<ul style="list-style-type: none"> • Connector Actassi S-One • With shutter and label space 		

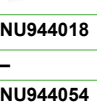

TV centre plates

	TV/FM	R-TV/SAT
2-module		
		
<input type="checkbox"/> white	NU944018	NU944118
<input type="checkbox"/> aluminium	-	NU944130
<input type="checkbox"/> anthracite	NU944054	NU944154

Multimedia sockets

	HDMI
2 x 1-module	
	
<input type="checkbox"/> white	NU543018
<input type="checkbox"/> anthracite	NU543054
Characteristics	
Connector prewired	

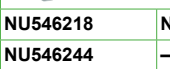
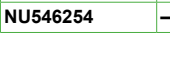
TV sockets

	TV male		
	individual	intermediate	terminal
2-module			
			
<input type="checkbox"/> white	NU546218	NU546318	NU546418
<input type="checkbox"/> beige	NU546244	-	-
<input type="checkbox"/> anthracite	NU546254	-	NU546454

Inserts with fixing frame

Other functions

Blind covers

2-module	
	

<input type="checkbox"/> white	NU586618
--------------------------------	-----------------

Light signalling

Lamp and bell push button	
	

<input type="checkbox"/> white	NU577718
<input type="checkbox"/> aluminium	NU577730
<input type="checkbox"/> anthracite	NU577754

Cable outlets

2-module	
	

<input type="checkbox"/> white	NU586218
<input checked="" type="checkbox"/> anthracite	NU586254

Characteristics	
Cable outer diameter: 12 mm	

Unica Inserts with Fixing Frame and Claws

Contents

Switches	100
Sockets	102
Data / Phone / TV	103

Inserts with fixing frame and claws Switches

10 AX – 250 V AC switches



	Standard			With locator lamp	
	one-way	two-way	intermediate	one-way	two-way
2-module					
<input type="checkbox"/> white	NU520118Z	NU520318Z	NU520518Z	NU520118NZ	NU520318NZ
<input type="checkbox"/> beige	NU520144Z	NU520344Z	-	-	-
2 x 1-module					
<input type="checkbox"/> white	NU521118Z	-	-	NU521118NZ	-
<input type="checkbox"/> beige	NU521144Z	-	-	-	-
Characteristics					
<ul style="list-style-type: none"> • Connection: screwless terminals • Cables: 1 to 2,5 mm² rigid/flexible • Lighttable with NU9825A, NU9823AM and NU9825AZ LED lamps and rockers with visor 					

10 AX – 250 V AC push buttons

NO	
2-module	
<input type="checkbox"/> white	NU520618Z
<input type="checkbox"/> beige	NU520644Z
Characteristics	
<ul style="list-style-type: none"> • Connection: screwless terminals • Cables: 1 to 2.5 mm² rigid/flexible • Lighttable with NU9825A, NU9823AM and NU9825AZ LED lamps and rockers with visor 	

Inserts with fixing frame and claws Switches

Accessories – Lamps

LED lamps	12-24 V DC	250 V AC	
	white	red	white
			
	NU9823AM	NU9825A	NU9825AZ





Characteristics			
Consumption	0.15 mA	1,5 mA	0,05 mA

Spring to transform a switch to push button





S520299	
Characteristics	
10 units delivered with a positioning aid tool	



Accessories – Rockers

Rockers	without symbol	with visor
2-module		
		
<input type="checkbox"/> white	NU920018	NU920018N
<input type="checkbox"/> aluminium	NU920030	NU920030N
<input type="checkbox"/> beige	NU920044	–
<input type="checkbox"/> anthracite	NU920054	NU920054N
1-module		
		
<input type="checkbox"/> white	NU910018	NU910018N
<input type="checkbox"/> aluminium	NU910030	NU910030N
<input type="checkbox"/> beige	NU910044	–
<input type="checkbox"/> anthracite	NU910054	NU910054N

Inserts with fixing frame and claws Sockets

Side Earth sockets

	With Shutter	Without Shutter
	Screw terminal	Screw terminal
2-module		
		
<input type="checkbox"/> white	NU503718Z	NU503618Z
<input type="checkbox"/> beige	-	NU503644Z
Characteristics		
2P+E - 16 A - 250 V		

Centres plates for Side Earth Sockets	
2-module	
	
<input type="checkbox"/> beige	NU903744
For Unica MGU●●●●●●	
2-module	
	
<input type="checkbox"/> white	NU903718U

Inserts with fixing frame and claws

Data / Phone / TV

RJ45 data sockets

RJ45	Cat. 5e UTP zamak fixing frame
2-module	
	
<input type="checkbox"/> white	NU541118Z
<input type="checkbox"/> beige	NU541144Z
Characteristics	
<ul style="list-style-type: none"> • Connector Actassi S-One • With shutter and label space 	

TV sockets

	TV male individual
2 modules	
	
<input type="checkbox"/> white	NU546218Z
<input type="checkbox"/> beige	NU546244Z

Unica Complete Offer: Inserts with Fixing Frame and Cover Frame



Contents

Switches	106
Sockets	107

Inserts with fixing frame and cover frame

Switches

Accessories – Lamps

LED lamps	12-24 V DC	250 V AC	
	White	Red	White
			
	NU9823AM	NU9825A	NU9825AZ
Characteristics			
Consumption	0.15 mA	1.5 mA	0.05 mA

Spring to transform a switch to push button







S520299

Characteristics

10 units delivered with a positioning aid tool



Accessories – Rockers

Rockers	without symbol	with visor
2-module		
		
<input type="checkbox"/> white	NU920018	NU920018N
<input type="checkbox"/> aluminium	NU920030	NU920030N
<input type="checkbox"/> beige	NU920044	–
<input type="checkbox"/> anthracite	NU920054	NU920054N
1-module		
		
<input type="checkbox"/> white	NU910018	NU910018N
<input type="checkbox"/> aluminium	NU910030	NU910030N
<input type="checkbox"/> beige	NU910044	–
<input type="checkbox"/> anthracite	NU910054	NU910054N

Inserts with fixing frame and cover frame

Sockets

Side Earth sockets

90°	IP44 frame with SO screws	With shutter and outer plate
2-module		
		
<input type="checkbox"/> white	NU003718	NU203718
<input type="checkbox"/> beige	NU003744	–
Characteristics		
2P+E - 16 A - 250 V		

Unica

Installation:

Fixing Frames and Boxes

Contents

Fixing frames	110
Boxes	112

Fixing frames and Boxes

Fixing frames

Fixing frames for CE60 boxes

1-gang or 2-module			
Zamak	Plastic	Zamak with paint protector	Plastic with paint protector
NU7002	NU7002P	NU7002C	NU7002PC NU7002PCP ⁽¹⁾

(1) pack of 100 units

Zamak with claws	Plastic with claws
NU7002G	NU7002PG

2-gang or 4-module	3-gang or 6/8-module	4-gang or 10-module
Plastic with paint protector	Zamak with paint protector	Zamak with paint protector
NU7004PC	NU7006C	NU7008C

Fixing frames for rectangular boxes

3-module		4-module		7-module
Zamak	Plastic	Zamak	Plastic	zamak
NU7103	NU7103P	NU7104	NU7104P	NU7107





Characteristics

Delivered with paint protection

Fixing frames and Boxes

Fixing frames

Accessories









Claws	Paint protector	Adaptor	Support for vertical installations
			
NU7892	NU7802	U0.582	2-module
Characteristics			
<ul style="list-style-type: none"> • For zamak fixing frames • With green plastic protection 	For 2-module	For MGU7.●●● fixing frames	<input type="checkbox"/> white NU9580
Characteristics			
To install inserts in vertical trunking in right position			

Unica







Fixing frames and Boxes

Boxes

Surface boxes

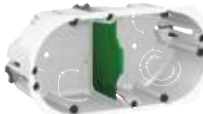

	1-gang	2-gang	3-gang	3-module	4-module
For Unica Studio cover frames					
					
□ white	NU800218	NU800418	NU800618	NU810318	NU810418
■ beige	NU800244	NU800444	NU800644	-	-
For Unica Pro cover frames					
					
□ white	NU840218	NU840418	NU840618		
■ anthracite	NU840254	NU840454	NU840654		

Multifix flush mounting boxes



1-gang	2-gang	3-gang	4-gang
40 mm depth			
			
IMT35914⁽¹⁾ IMT35914P⁽²⁾	IMT35924	IMT35934	IMT35944
50 mm depth			
			
IMT35915	IMT35925	IMT35935	IMT35945

(1) pack of 50 units.
 (2) pack of 300 units.

Flush mounting boxes

1-module	3-module	4-module
		
MGU8.601	MGU8.603	MGU8.604

Accessories

Divider	
	
IMT35994	IMT35995⁽¹⁾
Characteristics	
• for 40 mm depth boxes	• for 50 mm depth boxes
(1) pack of 10 units.	



Unica

Cover Frames











Contents

Standard cover frames	116
Special cover frames	120









Cover frames

Standard cover frames

Unica Deco Essentials

		white	aluminium	anthracite	light grey	taupe
						
1-gang		NU600218	NU600230	NU600254	NU600224	NU600226
2-gang		NU600418	NU600430	NU600454	NU600424	NU600426
3-gang		NU600618	NU600630	NU600654	NU600624	NU600626
4-gang		NU600818	NU600830	NU600854	NU600824	NU600826
5-gang		NU601018	NU601030	NU601054	-	-

Unica Deco Subtle

		white/silver	anthracite/copper	white/copper	anthracite/silver
					
1-gang		NU600240	NU600241	NU600242	NU600243
2-gang		NU600440	NU600441	NU600442	NU600443
3-gang		NU600640	NU600641	NU600642	NU600643
4-gang		NU600840	NU600841	NU600842	NU600843

Unica Deco Signature



























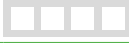
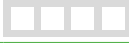
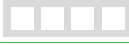
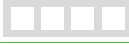













		terracotta	rubber	chipped wood	slate	translucent white
						
1-gang		NU600271	NU600272	NU600274	NU600277	NU600279
2-gang		NU600471	NU600472	NU600474	NU600477	NU600479
3-gang		NU600671	NU600672	NU600674	NU600677	NU600679
4-gang		NU600871	NU600872	NU600874	NU600877	NU600879

Unica

Cover frames

Standard cover frames

Unica Studio

	white	aluminium	beige	anthracite
				
1-gang (2 mod.)	 NU200218	 NU200230	 NU200244	 NU200254
2-gang (2 x 2 mod.)	 NU200418	 NU200430	 NU200444	 NU200454
3-gang (3 x 2 mod.)	 NU200618	 NU200630	 NU200644	 NU200654
4-gang (4 x 2 mod.)	 NU200818	 NU200830	 NU200844	 NU200854
5-gang (5 x 2 mod.)	 NU201018	 NU201030	 NU201044	 NU201054
1-module	 NU210118	 NU210130	 NU210144	 NU210154
2-module	 NU210218	 NU210230	 NU210244	 NU210254
3-module	 NU210318	 NU210330	 NU210344	 NU210354
4-module	 NU210418	 NU210430	 NU210444	 NU210454
7-module	 NU210718	 NU210730	 NU210744	 NU210754

Unica Studio Color

Front colour	light green		red	plum		chocolate		
Back colour	white	beige	white	white	beige	white	black	
								
1-gang (2 mod.)	NU280211	-	NU280213	NU280214	-	NU280216	NU280217	
2-gang (2 x 2 mod.)	NU280411	-	NU280413	NU280414	-	NU280416	NU280417	
3-gang (3 x 2 mod.)	NU280611	-	NU280613	NU280614	-	NU280616	NU280617	
4-gang (4 x 2 mod.)	NU280811	-	NU280813	NU280814	-	NU280816	NU280817	
3-module	NU270311	NU270312	NU270313	NU270314	NU270315	NU270316	NU270317	
4-module	NU270411	NU270412	NU270413	NU270414	-	NU270416	NU270417	
7-module	NU270711	NU270712	NU270713	NU270714	-	NU270716	NU270717	
Front colour	white	dark grey		light grey	taupe			beige
Back colour	white	white	black	white	white	beige	black	beige
								
1-gang (2 mod.)	NU280218	NU280221	NU280222	NU280224	NU280226	NU280227	NU280228	NU280244
2-gang (2 x 2 mod.)	NU280418	NU280421	NU280422	NU280424	NU280426	NU280427	NU280428	NU280444
3-gang (3 x 2 mod.)	NU280618	NU280621	NU280622	NU280624	NU280626	NU280627	NU280628	NU280644
4-gang (4 x 2 mod.)	NU280818	NU280821	NU280822	NU280824	NU280826	NU280827	NU280828	NU280844
3-module	NU270318	NU270321	NU270322	NU270324	NU270326	NU270327	NU270328	NU270344
4-module	NU270418	NU270421	NU270422	NU270424	NU270426	NU270427	NU270428	NU270444
7-module	NU270718	NU270721	NU270722	NU270724	NU270726	NU270727	NU270728	-

Cover frames

Standard cover frames

Unica Studio Metal

Front colour	bronze			dark aluminium	white aluminium		copper	
Back colour	white	beige	black	black	white	black	white	black
								
1-gang (2 mod.) 	NU280250M ⁽²⁾	NU280251M ⁽²⁾	NU280252M ⁽²⁾	NU280253M ⁽²⁾	NU280255M ⁽²⁾	NU280256M ⁽²⁾	NU280257M ⁽²⁾	NU280258M ⁽²⁾
2-gang (2 x 2 mod.) 	NU280450M ⁽²⁾	NU280451M ⁽²⁾	NU280452M ⁽²⁾	NU280453M ⁽²⁾	NU280455M ⁽²⁾	NU280456M ⁽²⁾	NU280457M ⁽²⁾	NU280458M ⁽²⁾
3-gang (3 x 2 mod.) 	NU280650M ⁽²⁾	NU280651M ⁽²⁾	NU280652M ⁽²⁾	NU280653M ⁽²⁾	NU280655M ⁽²⁾	NU280656M ⁽²⁾	NU280657M ⁽²⁾	NU280658M ⁽²⁾
4-gang (4 x 2 mod.) 	NU280850M ⁽²⁾	NU280851M ⁽²⁾	NU280852M ⁽²⁾	NU280853M ⁽²⁾	NU280855M ⁽²⁾	NU280856M ⁽²⁾	NU280857M ⁽²⁾	NU280858M ⁽²⁾
3-module 	NU270350M ⁽²⁾	NU270351M ⁽²⁾	NU270352M ⁽²⁾	NU270353M ⁽²⁾	NU270355M ⁽²⁾	NU270356M ⁽²⁾	NU270357M ⁽²⁾	NU270358M ⁽²⁾
4-module 	NU270450M ⁽²⁾	NU270451M ⁽²⁾	NU270452M ⁽²⁾	NU270453M ⁽²⁾	NU270455M ⁽²⁾	NU270456M ⁽²⁾	NU270457M ⁽²⁾	NU270458M ⁽²⁾
7-module 	NU270750M ⁽²⁾	NU270751M ⁽²⁾	NU270752M ⁽²⁾	NU270753M ⁽²⁾	NU270755M ⁽²⁾	NU270756M ⁽²⁾	NU270757M ⁽²⁾	NU270758M ⁽²⁾
Front colour	gold							
Back colour	white	beige	black					
								
1-gang (2 mod.) 	NU280259M ⁽²⁾	NU280260M ⁽²⁾	NU280262M ⁽²⁾					
2-gang (2 x 2 mod.) 	NU280459M ⁽²⁾	NU280460M ⁽²⁾	NU280462M ⁽²⁾					
3-gang (3 x 2 mod.) 	NU280659M ⁽²⁾	NU280660M ⁽²⁾	NU280662M ⁽²⁾					
4-gang (4 x 2 mod.) 	NU280859M ⁽²⁾	NU280860M ⁽²⁾	NU280862M ⁽²⁾					
3-module 	NU270359M ⁽²⁾	NU270360M ⁽²⁾	NU270362M ⁽²⁾					
4-module 	NU270459M ⁽²⁾	NU270460M ⁽²⁾	NU270462M ⁽²⁾					
7-module 	NU270759M ⁽²⁾	NU270760M ⁽²⁾	NU270762M ⁽²⁾					









(1) Sand finish

(2) Mill finish

Cover frames



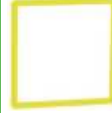
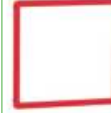



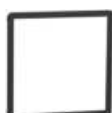



Standard cover frames

Unica Studio Outline

	white	yellow	red	plum	chocolate	light grey	aluminium	grey
								
1-gang 	NU230218	-	-	-	-	-	-	-
2-gang 	NU230418	-	-	-	-	-	-	-
3-gang 	NU230618	-	-	-	-	-	-	-
4-gang 	NU230818	-	-	-	-	-	-	-
5-gang 	NU231018	-	-	-	-	-	-	-
Inner frame								
								
	NU230018	NU230001	NU230013	NU230014	NU230016	NU230024	NU230030	NU230031

	beige	anthracite
		
Inner frame		
	NU230044	NU230054

Unica Pro

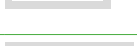
	white	aluminium	anthracite
			
1-gang (2 mod.) 	NU400218 NU400218P⁽¹⁾	NU400230	NU400254
2-gang (2 x 2 mod.) 	NU400418	NU400430	NU400454
3-gang (3 x 2 mod.) 	NU400618	NU400630	NU400654
4-gang (4 x 2 mod.) 	NU400818	NU400830	NU400854
4-module for double gang box 	NU411418	NU411430	NU411454
6-module for triple gang box 	NU411618	NU411630	NU411654
8-module for triple gang box 	NU411818	NU411830	NU411854
10-module for quadruple gang box 	NU411018	NU411030	NU411054

(1) pack of 100 units

Cover frames

Special cover frames





Thin panels cover frames

	white	aluminium	anthracite
			
1-module 	NU200118	NU200130	NU200154

IP 44 cover frame



	white
	
1-gang (2 mod.) 	NU044218

IP55 cover frame and boxes for CE60

Box cover with lid	Boxes for surface mounting					
	1-gang	2-gang, horizontal	2-gang, vertical	3-gang, horizontal		
						
<input type="checkbox"/> white	MUR39110	MUR39911	MUR39914	MUR39912	MUR39913	
<input checked="" type="checkbox"/> anthracite	MUR35110	MUR37911	MUR37914	MUR37912	MUR37713	
Characteristics						
	IP55 ⁽¹⁾ - IK06	IP55 ⁽²⁾ - IK08				

(1) when installed in a box or frame.

(2) when completed with covers.

Frames for flush mounting					
	1-gang	1-gang, with claws	2-gang, horizontal	2-gang, vertical	3-gang, horizontal
					
<input type="checkbox"/> white	MUR39107	MUR39108	MUR39101	MUR39151	MUR39109
<input checked="" type="checkbox"/> anthracite	MUR34107	MUR34108	MUR34101	MUR34151	MUR34109
Characteristics					
	IP55 ⁽²⁾ (on flat/smooth walls only. IP44 ⁽²⁾ if mounted on uneven walls with MUR34007 ref.) / IK08.				

(2) when completed with covers.

IP55 cover frame for rectangular boxes

	white	beige
		
3 module 	NU055318	NU055344
4 module 	NU055418	NU055444



Unica

Wiser

Contents







Wiser by SE	124
Wiser Home	127



Relay switches

10 A	Modular
2-module	
	
<input type="checkbox"/> white	NU353818
<input type="checkbox"/> aluminium	NU353830
<input checked="" type="checkbox"/> anthracite	NU353854
Characteristics	
<ul style="list-style-type: none"> Relay switch for various purposes such as weekly scheduling using Wiser app, presence simulation, count down timer LED indicates when switch is ON Remote control from smartphone or tablet using Wiser app Remote control by unlimited number of single mechanical push buttons 	<p>Via Wiser app</p> <ul style="list-style-type: none"> Setting a timer: delay time (1 second - 24 hours), prewarning (with or without), manual switching (OFF or retrigger) Setting a time schedule (weekday switching, astro function, count-down timer, presence simulation).

Dimmers

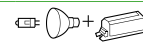
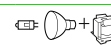
		Modular		Assembled with Fixing Frame	Compensation module LED
2-module		Push button	Rotary	Push button	
					
<input type="checkbox"/> white		NU351718	NU351818	NU551718	–
<input type="checkbox"/> aluminium		NU351730	NU351830	NU551730	–
<input type="checkbox"/> beige		–	–	NU551744	–
<input checked="" type="checkbox"/> anthracite		NU351754	NU351854	NU551754	–
Load compensation module					CCT90501
Maximum loads					
LED lamp 230 V		RC: 7...100 VA RL: 7...20 VA	RC: 7...100 VA RL: 7...20 VA	RC: 7...100 VA RL: 7...20 VA	
incandescent lamp 230 V		14...200 W	14...200 W	14...200 W	
halogen lamp 230 V		14...150 W	14...150 W	14...150 W	
LV halogen lamps 12 V	electronic transformer  wound transformer 	14...150 W	14...150 W	14...150 W	
Characteristics					
<ul style="list-style-type: none"> Remote control from auxiliary push-buttons Automatic load detection Wire configuration without neutral Memory function Automatic overload protection, overheating protection, short-circuit protection Additional functions like wake-up, fall asleep, scheduling and so on can be activated using the Wiser app Automatic load detection Brightness memory function Electronic overload, overheating and short-circuit protection 		<p>Via Wiser app</p> <ul style="list-style-type: none"> Remote control by unlimited number of single mechanical push buttons Setting the switch-ON brightness or memory function (default setting) Setting the dimming range: minimum and maximum brightness Setting the LED operating mode manually (RL LED mode) Setting a timer or a time schedule 		<ul style="list-style-type: none"> Rated voltage: 230 VAC Frequency range: 50 - 60 Hz Power loss: 2 W max Installation: junction box, in the luminaire or in the sub-distribution panel, wired between neutral and dimmed phase. 	



For more detailed information, refer to the Wiser Guides online. Scan the QR code or follow the link:
https://www.productinfo.schneider-electric.com/wiser_eu/



Download
Wiser by SE app
Schneider Electric's connected
technology for homes



Shutters control

Modular	
2-module	
<input type="checkbox"/> white	NU350918
<input type="checkbox"/> aluminium	NU350930
<input type="checkbox"/> anthracite	NU350954
Characteristics	
<ul style="list-style-type: none"> Control of blinds locally from the switch or remotely from smartphone or tablet using Wiser app Weekly scheduling Astro function Presence simulation Can be used for controlling up to 10 multiple relays, each controlling one blind motor Remote control by unlimited number of double push buttons, distance: 50 m 	<ul style="list-style-type: none"> Protection of the motor against damage with two mutually electrically locked relay contacts Central control of multiple blind groups push buttons <p>Via Wiser app:</p> <ul style="list-style-type: none"> Setting the blind movement time Management of blind and slat position Upgrade device firmware

Motion sensors

		Modular	
2-module		with relay switch	with dimmer
<input type="checkbox"/> white		NU352618	NU352718
<input type="checkbox"/> aluminium		NU352630	NU352730
<input type="checkbox"/> anthracite		NU352654	NU352754
Maximum loads			
LED lamp 230 V		200 W	RC: 7... 100 VA RL : 7...20 VA
compact fluorescent lamp		200 W	–
incandescent lamp 230 V		2200 W	14...200 W
halogen lamp 230 V		2000 W	14...150 W
LV halogen lamps 12 V	electronic transformer 	1050 VA	14...150 W
	wound transformer 	500 VA	14...150 W
Characteristics			
<ul style="list-style-type: none"> Wire configuration with neutral Movement detection area 8 m frontal, 8 m lateral Movement detection angle: 160 ° Configuration with time delay range, triggering light level is done using the Wiser app Built-in push button switch for dim (only with dimmer version) and ON/OFF switching Automatic mode: Automatic switching ON of loads when a motion is detected and dependent on the ambient brightness Manual operation: Local switching ON of loads when the switch is actuated, irrespective of the ambient brightness Semi-automatic mode: Manual switch-ON/automatic switch-OFF Remote control by unlimited number of single mechanical push buttons 		<p>Via Wiser app:</p> <ul style="list-style-type: none"> Setting the detection brightness: 5 to 1000 lux (default setting 50 lux) Setting the detection sensitivity: High (default setting), medium or low Setting the detection sensitivity: High (default setting), medium or low Setting the overtravel time: 1 second to 30 minutes (default setting 5 minutes) Setting a timer or a time schedule 	
		See Dimmers for others characteristics	



For more detailed information, refer to the Wiser Guides online. Scan the QR code or follow the link:
https://www.productinfo.schneider-electric.com/wiser_eu/



Connected sockets

16 A	German socket
	
<input type="checkbox"/> white	NU555718
<input type="checkbox"/> aluminium	NU555730
<input type="checkbox"/> anthracite	NU555754



For more detailed information, refer to the Wiser Guides online. Scan the QR code or follow the link:
https://www.productinfo.schneider-electric.com/wiser_eu/







Relay switches

10 A	Modular
2-module	
	
<input type="checkbox"/> white	NU353718W
<input type="checkbox"/> aluminium	NU353730W
<input checked="" type="checkbox"/> graphite	NU353754W
Characteristics	
<ul style="list-style-type: none"> Relay switch for various purposes such as weekly scheduling using Wiser app, presence simulation, count-down timer LED indicates when switch is ON Remote control from smartphone or tablet using Wiser app Remote control by unlimited number of single mechanical push buttons 	
Via Wiser app	
<ul style="list-style-type: none"> Setting a timer: delay time (1 second - 24 hours), prewarning (with or without), manual switching (off or retrigger) Setting a time schedule (weekday switching, astro function, count-down timer, presence simulation). 	

Shutters control

	Modular
2-module	
	
<input type="checkbox"/> white	NU350818W
<input type="checkbox"/> aluminium	NU350830W
<input checked="" type="checkbox"/> anthracite	NU350854W
Characteristics	
<ul style="list-style-type: none"> Control of blinds locally from the switch or remotely from smartphone or tablet using Wiser app Weekly scheduling Astro function Presence simulation Can be used for controlling up to 10 multiple relays, each controlling one blind motor Remote control by unlimited number of double push buttons, distance: 50 m Protection of the motor against damage with two mutually electrically locked relay contacts Central control of multiple blind groups push buttons 	
Via Wiser app:	
<ul style="list-style-type: none"> Setting the blind movement time Management of blind and slat position Upgrade device firmware 	

Dimmers

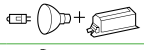
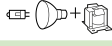
Modular	Compensation module LED		
2-module	Push button	Rotary	
			
<input type="checkbox"/> white	NU351518W	NU351618W	-
<input checked="" type="checkbox"/> graphite	NU351554W	NU351654W	-
Load compensation module			
	-	-	CCT90501
Maximum loads			
LED lamp 230 V		RC: 7...100 VA RL: 7...20 VA	RC: 7...100 VA RL: 7...20 VA
incandescent lamp 230 V		14...200 W	14...200 W
halogen lamp 230 V		14...150 W	14...150 W
LV halogen lamps 12 V	electronic transformer 	14...150 W	14...150 W
	wound transformer 	14...150 W	14...150 W
Characteristics			
<ul style="list-style-type: none"> Remote control from auxiliary push-buttons Automatic load detection Wire configuration without neutral Memory function Automatic overload protection, overheating protection, short-circuit protection Additional functions like wake-up, fall asleep, scheduling. Can be activated using the Wiser app Automatic load detection Brightness memory function Electronic overload, overheating and short-circuit protection 		<ul style="list-style-type: none"> Rated voltage: 230 VAC Frequency range: 50 - 60 Hz Power loss: 2 W max. Installation: junction box, in the luminaire or in the sub-distribution panel, wired between neutral and dimmed phase. 	
<ul style="list-style-type: none"> Via Wiser app Remote control by unlimited number of single mechanical push buttons Setting the switch-on brightness or memory function (default setting) Setting the dimming range: minimum and maximum brightness Setting the LED operating mode manually (RL LED mode) Setting a timer or a time schedule 			



For more detailed information, refer to the Wiser Guides online. Scan the QR code or follow the link:
https://www.productinfo.schneider-electric.com/wiser_home



Connected sockets

16 A	Pin Earth socket
	
<input type="checkbox"/> white	NU555918
<input checked="" type="checkbox"/> anthracite	NU555954

Connected wireless switches

Modular	1-2-gang
	
<input type="checkbox"/> white	NU557118W
<input type="checkbox"/> aluminium	NU557130W
<input checked="" type="checkbox"/> anthracite	NU557154W



For more detailed information, refer to the Wiser Guides online. Scan the QR code or follow the link:
https://www.productinfo.schneider-electric.com/wiser_home



Unica

KNX

Contents

Controls

132

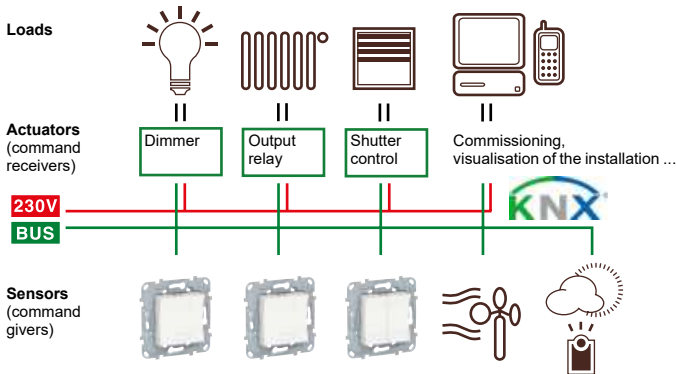

The following Unica control devices have to be connected to KNX bus line.
The KNX bus line is laid in parallel to the 230 V power supply.
When Unica sensor is activated, an actuator (e.g. the roller shutter control) will carry out all the switching commands required.

Introduction



KNX Push buttons

Push buttons	2 buttons and 2 blue status LEDs, with screwless bus connecting terminals	4 buttons and 4 blue status LEDs, with screwless bus connecting terminals
2-module		

		
<input type="checkbox"/> white	NU553018	NU553118
<input type="checkbox"/> aluminium	NU553030	NU553130
<input type="checkbox"/> anthracite	NU553054	NU553154

Characteristics	
<ul style="list-style-type: none"> • The status LED is located under the symbol window which can be taken off. • With integrated bus coupler. The bus is connected using a bus connecting terminal. Contents: <ul style="list-style-type: none"> • With set of 10 symbols: <ul style="list-style-type: none"> - 2 x symbol with light opening, - 1 x symbol "1", - 1 x symbol "0", - 2 x symbol for dimming, - 2 x symbol for shutter, - 2 x symbol (neutral). • With bus connecting terminal. 	<ul style="list-style-type: none"> • The status LED is located under the symbol window which can be taken off. • With integrated bus coupler. The bus is connected using a bus connecting terminal. Contents: <ul style="list-style-type: none"> • With set of 20 symbols: <ul style="list-style-type: none"> - 4 x symbol with light opening, - 2 x symbol "1", - 2 x symbol "0", - 4 x symbol for dimming, - 4 x symbol for shutter, - 4 x symbol (neutral). • With bus connecting terminal.

KNX software functions: Switching, toggling, dimming (single/dual-surface), blind (single/dual-surface), pulse edges trigger 1-, 2-, 4- or 8-bit telegrams (distinction between short and long operation), pulse edges with 2-byte telegrams (distinction between short and long operation), 8-bit linear regulator, scene retrieval, scene saving, disable functions.



Unica

Antibacterial offer







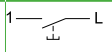
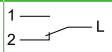

Contents

Switches	136
Specialized controls	138
Comfort devices	139
Sockets	140
Data / Phone / TV	142
Other functions	143
Wiser Home functions	144
Cover frames	145
System+	146





Antibacterial offer

Switches

10 AX – 250 V AC switches

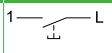
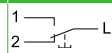
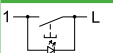

	One-way	Two-way	Intermediate
			
2-module			
			
<input type="checkbox"/> white antibacterial	NU320120	NU320320	NU320520
1-module			
			
<input type="checkbox"/> white antibacterial	NU310120	NU310320	NU310520
Characteristics			
<ul style="list-style-type: none"> • Connection: screwless terminals • Cables: 1 to 2,5 mm² rigid/flexible • Lightable with NU9825A, NU9823AM and NU9825AZ LED lamps and rockers with visor 			

10 A – 250 V AC push buttons

	NO without symbol	NO/NC with label holder	NO with locator lamp without symbol
			
2-module			
			
<input type="checkbox"/> white antibacterial	NU320620	NU324620	NU320620N
1-module			
			
<input type="checkbox"/> white antibacterial	NU310620	-	-
Characteristics			
<ul style="list-style-type: none"> • Connection: screwless terminals • Cables: 1.5 to 2.5 mm² rigid/flexible • Lightable with NU9825A, NU9823AM and NU9825AZ LED lamps and rockers with visor 			

Antibacterial offer Switches

Accessories – Lamps

LED lamps	12-24 V DC	250 V AC	
	white	red	white
			
	NU9823AM	NU9825A	NU9825AZ
Characteristics			
Consumption	0.15 mA	1.5 mA	0.05 mA

Spring to transform a switch to push button







S520299

Characteristics

10 units delivered with a positioning aid tool

Accessories – Rockers

Rockers	without symbol	with visor
2-module		
		
<input type="checkbox"/> white antibacterial	NU920020	NU920020N
1-module		
		
<input type="checkbox"/> white antibacterial	NU910020	NU910020N

Antibacterial offer

Specialized controls

Fan control

	Two-way – 10 A
2-module	
	
<input type="checkbox"/> white antibacterial	NU320320VMC
<input type="checkbox"/> aluminium	NU320330VMC
<input type="checkbox"/> anthracite	NU320354VMC

Roller blinds control

	One-way – 6 A
2-module	
	
<input type="checkbox"/> white antibacterial	NU320820





Cord push button

	NO/NC – 10 A
2-module	
	
<input type="checkbox"/> white antibacterial	NU322620

Antibacterial offer



Comfort devices

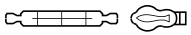
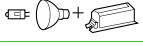
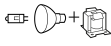





Dimmer

		Universal	Compensation module LED
2-module			
<input type="checkbox"/> white antibacterial		NU351420	-
Load compensation module			CCT90501
Maximum loads			
LED lamp 230 V		RC: 5...100 VA RL : 5...20 VA	
incandescent lamp 230 V		5...200 W	
halogen lamp 230 V		5...150 W	
LV halogen lamps 12 V	electronic transformer 	5...150 VA	
	wound transformer 	5...150 VA	
Characteristics			
<ul style="list-style-type: none"> • Remote control by unlimited number of auxiliary push-button • Automatic load detection • Wire configuration without neutral • Screw terminal connection • Memory function • Automatic overload protection, overheating protection, short-circuit protection 		<ul style="list-style-type: none"> • Rated voltage: 230 VAC • Frequency range: 50 - 60 Hz • Power loss: 2 W max. • Installation: junction box, in the luminaire or in the sub-distribution panel, wired between neutral and dimmed phase. 	



Antibacterial offer Sockets

Pin Earth sockets

90°	Standard	Surface	Tamperproof
2-module			
			
<input type="checkbox"/> white antibacterial	NU305920	NU305220	-
<input checked="" type="checkbox"/> red	NU305903	NU305203	NU305103
<input checked="" type="checkbox"/> green	NU305906	NU305206	-
Characteristics			
<ul style="list-style-type: none"> • 2P+E - 16 A - 250 V • With shutters • Screwless terminals (except NU305103) 			

45°	Standard			With lamp	Tamperproof		Tamperproof with lamp
	2-module	4-module	6-module	4-module	4-module	6-module	4-module
							
<input type="checkbox"/> white antibacterial	NU304920	-	-	-	-	-	-
<input checked="" type="checkbox"/> red	NU304903	NU306903	NU307903	NU306903S	NU306103	NU307103	NU306103S
<input checked="" type="checkbox"/> green	NU304906	NU306906	NU307906	-	-	-	-
Characteristics							
<ul style="list-style-type: none"> • 2P+E - 16 A - 250 V • With shutters • Screwless terminals 							

90°	Standard	Surface	Tamperproof
2-module			
			
<input checked="" type="checkbox"/> red	NU305903T	NU305203T	NU305103T
Characteristics			
<ul style="list-style-type: none"> • 2P+E - 16 A - 250 V • With shutters • Screwless terminals (except NU305103T) 			

45°	Standard			Tamperproof	
	2-module	4-module	6-module	4-module	6-module
					
<input checked="" type="checkbox"/> red	NU304903T	NU306903T	NU307903T	NU306103T	NU307103T
Characteristics					
<ul style="list-style-type: none"> • 2P+E - 16 A - 250 V • With shutters • Screwless terminals 					

Antibacterial offer

Sockets

Side Earth sockets







Standard		
2-module		
		
<input type="checkbox"/> white antibacterial	NU303720	NU305720
Characteristics		
<ul style="list-style-type: none"> ● 2P+E - 16 A - 250 V ● With shutters ● Screw terminals 	<ul style="list-style-type: none"> ● 2P+E - 16 A - 250 V ● With shutters ● Screwless terminals 	

45°		Standard
4-module		Screw *
		
<input type="checkbox"/> white	NU306720A	
Characteristics		
<ul style="list-style-type: none"> ● 2P+E - 16 A - 250 V ● * for Screw devices - Screw-IPT terminals ● With shutters 		

Antibacterial offer

Data / Phone / TV

RJ45 Centre plates

	For S-One RJ45 connector		RJ45 Cover Keystone/ Systimax
	straight	inclined	
2-module			
<input type="checkbox"/> white antibacterial			
	NU941120	NU940720	NU946120
<input type="checkbox"/> white antibacterial		-	-
	NU942020	-	-
1-module			
<input type="checkbox"/> white antibacterial			
	NU941020	NU940620	NU946020
Characteristics			
<ul style="list-style-type: none"> • Straight : with shutter and label space • Inclined : with label space 			



TV sockets

	TV	FM/TV/SAT
	Male, individual	Individual (1 cable)
2-module		
<input type="checkbox"/> white antibacterial		
	NU346220	NU345020
1-module		
<input type="checkbox"/> white antibacterial		-
	NU346120	-

Antibacterial offer

Other functions

Blind covers

Blind covers	
2-module	
	
<input type="checkbox"/> white antibacterial	NU986620
1-module	
	
<input type="checkbox"/> white antibacterial	NU986520

Antibacterial offer Wiser Home functions









Connected wireless switches

Modular	
1-2-gang	
	
<input type="checkbox"/> white antibacterial	NU557120W

Antibacterial offer

Cover frames

Unica Pro

		white antibacterial
		
1-gang (2 mod.)		NU400220
2-gang (2 x 2 mod.)		NU400420
3-gang (3 x 2 mod.)		NU400620
4-module		NU411420
6-module		NU411620



Antibacterial offer

Complete workstations



Surface mounting workstations

	2 rows x 8-module	2 rows x 10-module	2 columns	3 columns	4 columns
					
<input type="checkbox"/> white antibacterial	NU121820	NU121020	NU122420	NU123420	NU124420



Flush mounting workstations

	2 rows x 8-module	2 rows x 10-module	3 columns
			
<input type="checkbox"/> white antibacterial	NU171820	NU171020	NU173420

Horizontal cover frames

	2 rows x 8 modules	2 rows x 10-module
Cover frames		
<input type="checkbox"/> white antibacterial	NU021820	NU021020

Horizontal surface boxes

	2 rows x 8 modules	2 rows x 10-module
Surface boxes		
<input type="checkbox"/> white antibacterial	NU821820	NU821020

Unica System+



Contents

Complete workstations	150
Horizontal centralizations	151
Vertical centralizations	152
Accessories	153

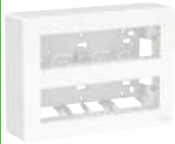

Unica System+

Complete workstations



Horizontal surface mounting workstations

	2 rows x 8-module	2 rows x 10-module
		
□ white	NU121820	NU121020
▒ aluminium	NU121830	-
■ anthracite	NU121854	NU121054



Vertical surface mounting workstations

	2 columns x 4-module	3 columns x 4-module	4 columns x 4-module
			
□ white	NU122418	NU123418	NU124418
▒ aluminium	NU122430	NU123430	NU124430
■ anthracite	NU122454	NU123454	NU124454

Horizontal flush mounting workstations

	2 rows x 8-module	2 rows x 10-module
		
□ white	NU171820	NU171020
■ anthracite	NU171854	NU171054

Vertical flush mounting workstations

	2 columns x 4-module	3 columns x 4-module	4 columns x 4-module
			
□ white	NU172418	NU173418	NU174418
▒ aluminium	NU172430	NU173430	NU174430
■ anthracite	NU172454	NU173454	NU174454

Unica System+

Horizontal centralizations

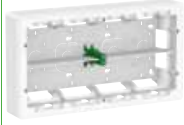

Surface mounting boxes

	3-gang 8-module	4-gang 10-module
		
<input type="checkbox"/> white	NU821820	NU821020
<input type="checkbox"/> aluminium	NU821830	NU821030
<input type="checkbox"/> anthracite	NU821854	NU821054

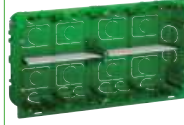
Flush mounting boxes

	3-gang 8-module	4-gang 10-module
		
	NU8718	NU8710

Cover frames

	2 rows x 8-module	2 rows x 10-module
Cover frame with fixing frame		
		
<input type="checkbox"/> white	NU021820	NU021020
<input type="checkbox"/> aluminium	NU021830	NU021030
<input type="checkbox"/> anthracite	NU021854	NU021054

Unica System+

Vertical centralizations

Surface mounting boxes

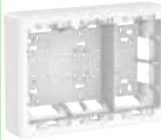
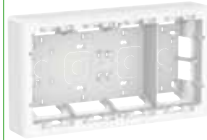
	2 columns x 4-module	3 columns x 4-module	4 columns x 4-module
			
<input type="checkbox"/> white	NU822418	NU823418	NU824418



Flush mounting boxes

	2 columns x 4-module	3 columns x 4-module	4 columns x 4-module
			
	NU8724	NU8734	NU8744

Cover frames

	2 columns	3 columns	4 columns
Cover frame with fixing frame			
			
<input type="checkbox"/> white	NU022418	NU023418	NU024418





Kits (inserts with cover frames)

	2 columns	3 columns	4 columns
			
<input type="checkbox"/> white	NU112118	NU113118	NU114118
	2 German sockets-outlets + 2 Centre plates without RJ45 connectors	2 German sockets-outlets + 2 German red sockets-outlets + 2 Centre plates without RJ45 connectors	4 German sockets-outlets + 2 German red sockets-outlets + 2 Centre plates without RJ45 connectors

Unica System+

Accessories

Mounting accessories

Fixing frame	Metal divider for flush mounting boxes		DIN rail adapter
			
NU7204P	NU9802	NU9801	NU9800
Characteristics			
For vertical solutions			For Acti9 devices installation (1 or 2-module of 18 mm)

Unica

Technical Information

Contents

Dimensions 156

Fixing frames	156
Cover frames	158
Fixing frames and Cover frames	159
Boxes	160

Connections 163

Switches	163
Comfort devices	166
Sockets	167
Wiser	168
Data / Phone / TV	169
USB chargers	170
Other functions	171
RJ45 data sockets	173

Unica

Dimensions

Fixing frames

Universal fixing frames

NU7002●●

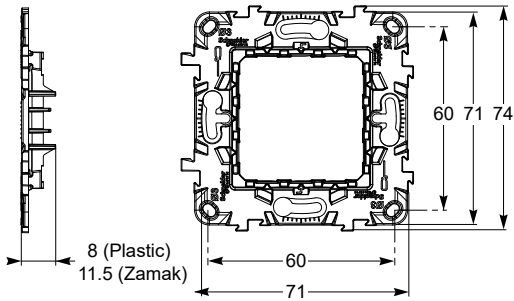

Zamak and plastic (2-module)

NU7103●●

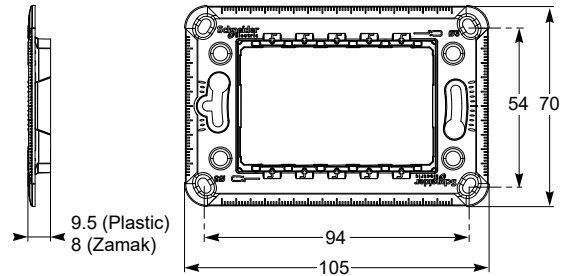

Zamak and plastic (3-module)

NU7104●●

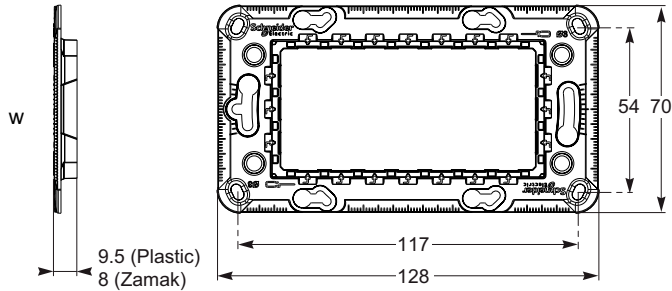

Zamak and plastic (4-module)

NU7107

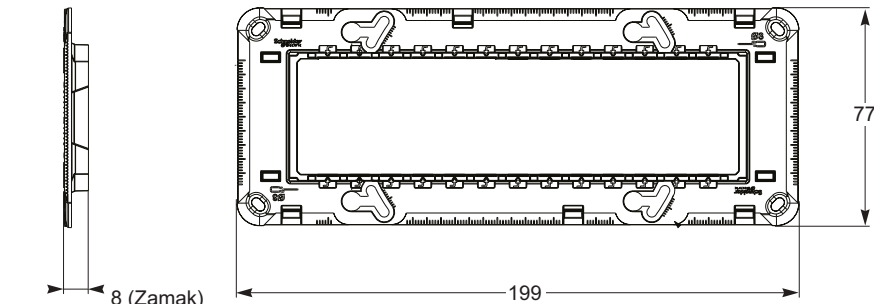

Zamak (7-module)

Unica

Dimensions

Fixing frames

Multigang fixing frames

NU7004PC

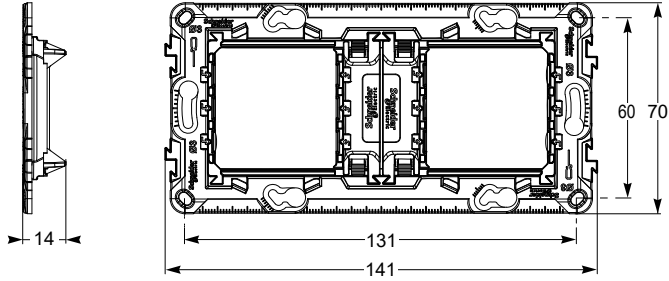

Plastic (2-gang or 4-module)

NU7006C

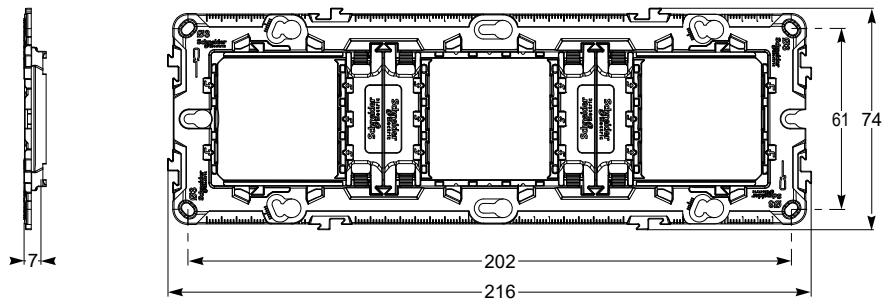

Zamak (3-gang or 6/8-module)

NU7008C

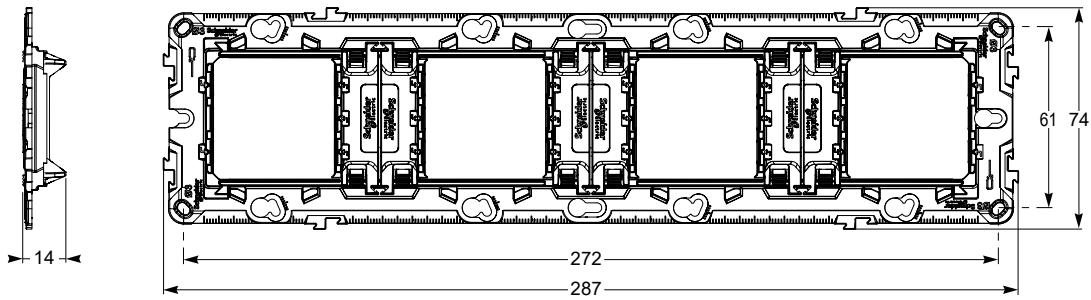

Zamak (4-gang or 10-module)

Unica

Dimensions

Cover frames

Gangs

NU200●●●
NU280●●●

NU600●●●

NU400●●●

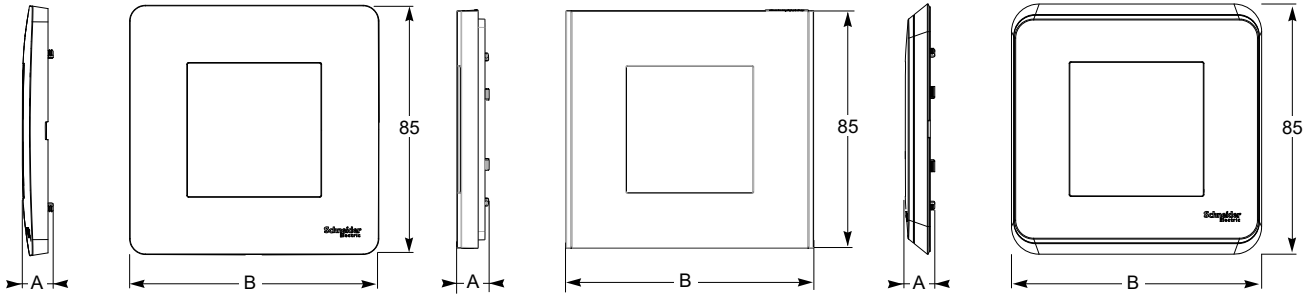

Unica Studio

Unica Deco

Unica Pro

Type	Depth	1-gang	2-gang	3-gang	4-gang	5-gang
	A	B	B	B	B	B
Unica Studio	10	85	156	227	298	369
Unica Deco	10	88	159	230	301	372
Unica Pro	10	85	156	227	298	-

Modules

NU210●●●
NU270●●●

NU411●●●

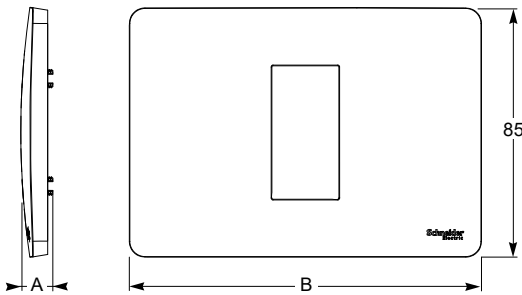

Unica Studio
Unica Studio Color
Unica Studio Metal

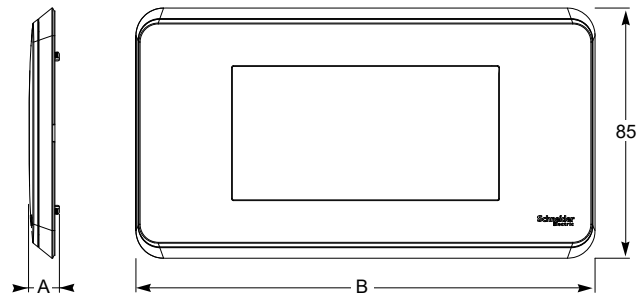

Unica Pro

Type	Depth	1, 2, 3-module	4-module	7-module
	A	B	B	B
Unica Studio	10	120	142	210

Type	Depth	4-module	6, 8-module	10-module
	A	B	B	B
Unica Pro	10	156	227	298

IP55 frames

NU055●●●

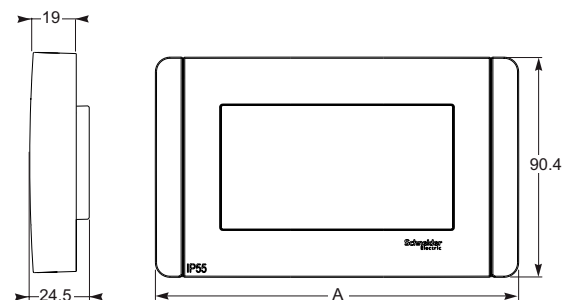

Type	3-module	4-module
	A	A
IP55	126	148.5

Dimensions

Fixing frames and Cover frames

Fixing frames

NU7204P

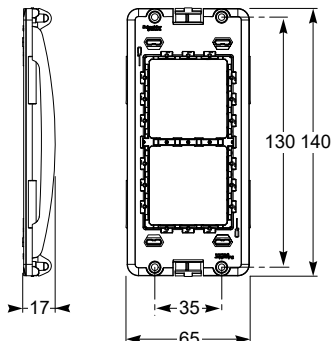

Cover frames

NU0218●●: 3-gang - 6 or 8-module

NU0210●●: 4-gang - 10-module

NU02●418: 2,3 and 4 columns - 4-module

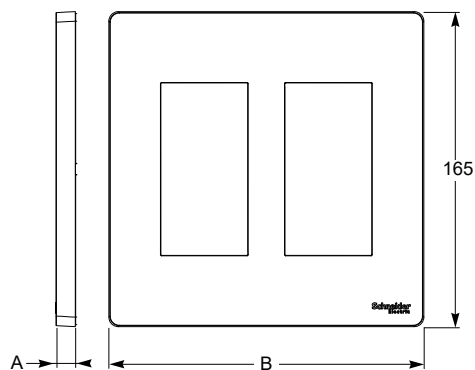
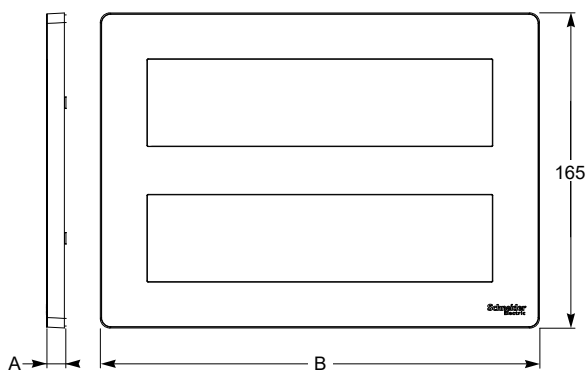

Horizontal cover frame

Vertical cover frame

Type	Depth	3-gang 6 or 8-module	4-gang 10-module	2 columns 4-module	3 columns 4-module	4 columns 4-module
	A	B	B	B	B	B
Cover frames	10	230	300	165	230	300

Unica

Dimensions

Boxes

Surface mounting boxes

NU800xyy

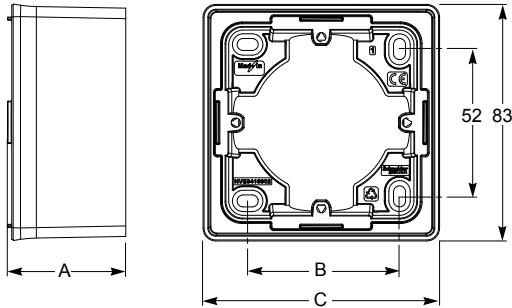

NU840xyy

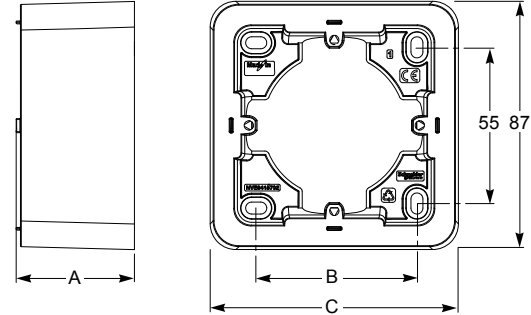

Unica Studio surface mounting boxes

Unica Pro surface mounting boxes

Type	Depth	1-gang		2-gang		3-gang	
		A	B	C	B	C	B
Unica Studio	41.5	53	83	124	154	195	224
Unica Pro	41.5	56	87	128	158	199	229

Where x denotes the length of surface mounting boxes.
Where yy denotes the color of surface mounting boxes. .

Flush mounting boxes

IMT359●4: 40 mm depth
IMT359●5: 50 mm depth

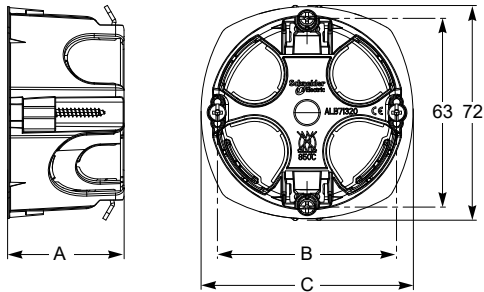

Multifix flush mounting boxes

Type	Depth		1-gang		2-gang		3-gang		4-gang	
	IMT359p4	IMT359p5	B	C	B	C	B	C	B	C
Multifix	40	50	60	71	71	141.5	71 x 2	212,5	71 x 3	283

MGU8.601: 35 mm depth
MGU8.603, MGU8.604: 48 mm depth

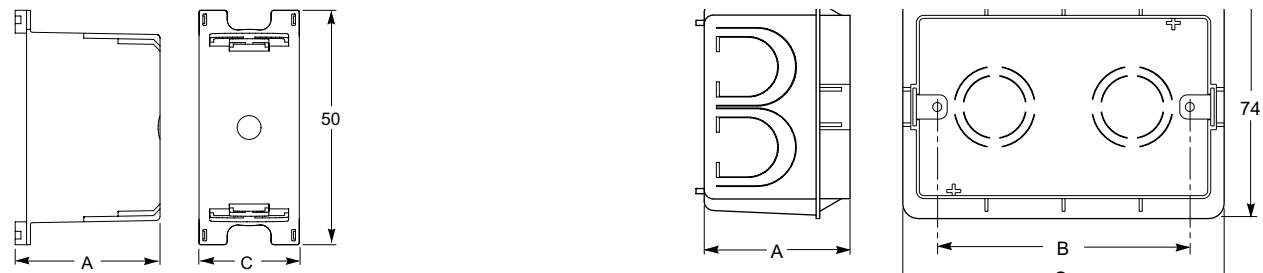

Flush mounting boxes

Type	Depth		1-module	3-module		4-module	
	MGU8.601	MGU8.603/604	C	B	C	B	C
Box	35	48	26.5	83.5	106	108	131

Flush mounting boxes

NU8718●●: 3-gang - 6 or 8-module

NU8710●●: 4-gang - 10-module

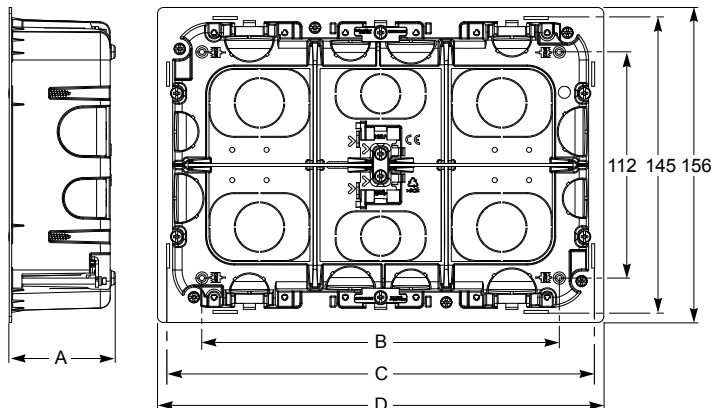

NU87●4: 2,3 and 4 columns - 8-module

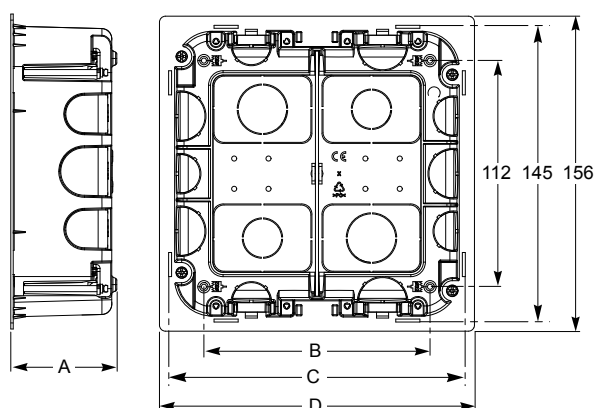

Horizontal flush centralization boxes

Vertical flush centralization boxes

Type	Depth	3-gang 6 or 8-module			4-gang 10-module			2 columns 4-module			3 columns 4-module			4 columns 4-module		
		A	B	C	D	B	C	D	B	C	D	B	C	D		
Flush mounting boxes	52.5	177	210	221	242	281	292	112	145	156	177	210	221	242	281	292

Centralization boxes

NU8218●●: 3-gang - 6 or 8-module

NU8210●●: 4-gang - 10-module

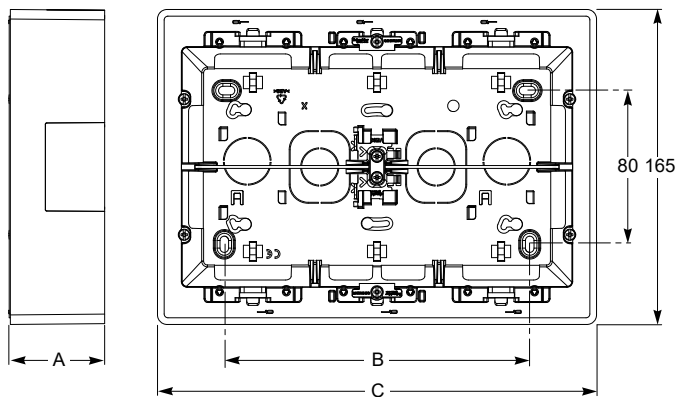

NU82●418: 2,3 and 4 columns - 8-module

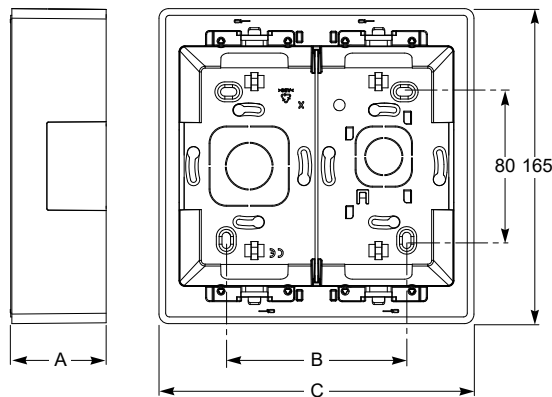

Horizontal centralization boxes

Vertical centralization boxes

Type	Depth	3-gang 6 or 8-module		4-gang 10-module		2 columns 4-module		3 columns 4-module		4 columns 4-module	
		B	C	B	C	B	C	B	C	B	C
Centralization boxes	50	160	230	233	300	94.5	165	160	230	233	300

Flush mounting workstations boxes

NU171●20: 2 rows - 8 or 10-module

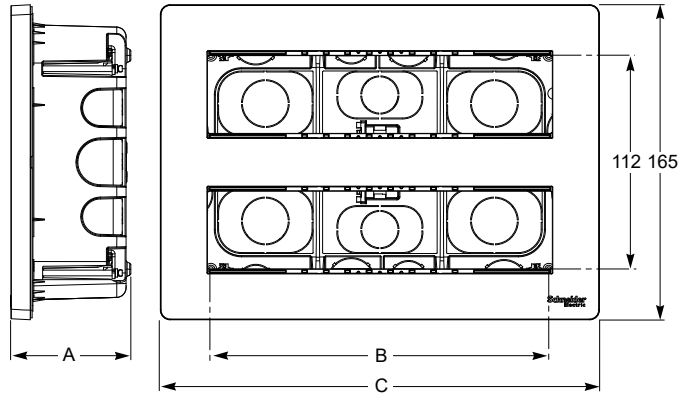

Horizontal flush mounting workstations boxes

NU17●418: 2, 3 and 4 columns - 8-module

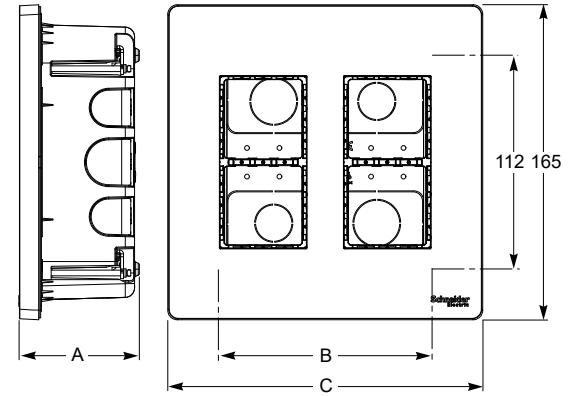

Vertical flush mounting workstations boxes

Type	Depth	2 rows 8-module		2 rows 10-module		2 columns 4-module		3 columns 4-module		4 columns 4-module	
		A	B	C	B	C	B	C	B	C	B
Flush mounting workstations boxes	63	177	230	248	300	112	165	177	230	248	300

Surface workstations boxes

NU121●20: 2 rows - 8 or 10-module

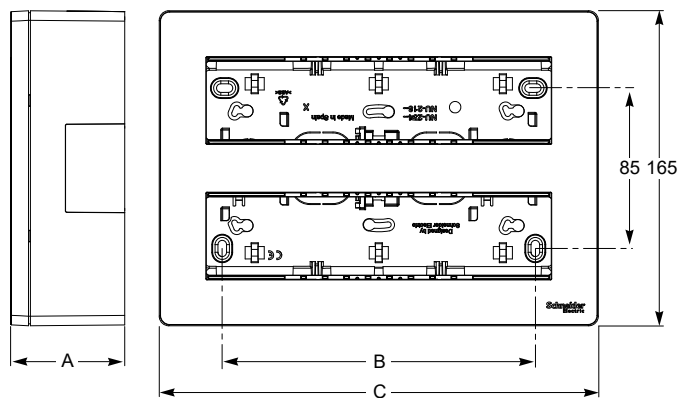

Horizontal surface workstations boxes

NU12●418: 2, 3 and 4 columns - 8-module

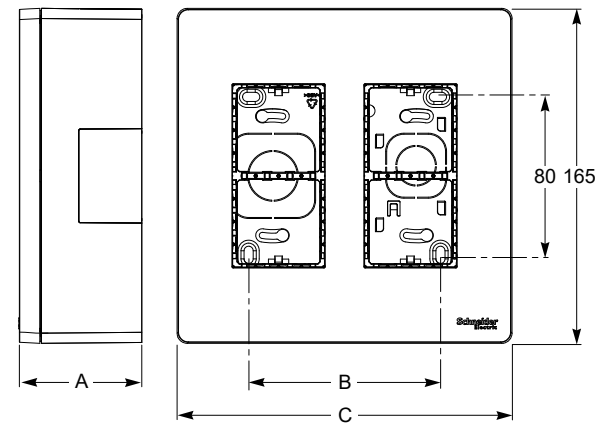

Vertical surface workstations boxes

Type	Depth	2 rows 8-module		2 rows 10-module		2 columns 4-module		3 columns 4-module		4 columns 4-module	
		A	B	C	B	C	B	C	B	C	B
Surface workstations boxes	60	160	230	233	300	94.5	165	160	230	233	300

Unica

Connections

Switches

Switches and push buttons

Connection examples

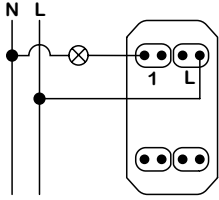

1-module - One-way switch
Push-button

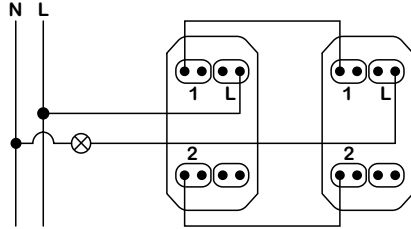

1-module - 2 two-way switches

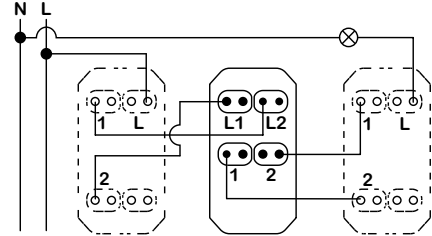

1-module - 2 two-way switches + 1 intermediate switch

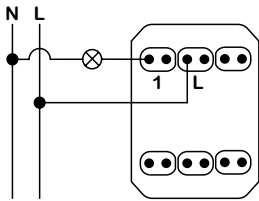

2-module - One-way switch
Push-button

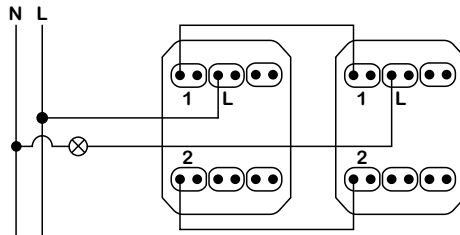

2-module - Two-way switch

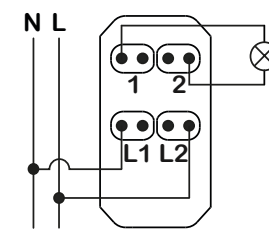

2 poles switch

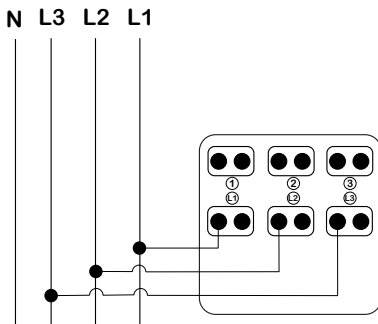

3 poles switch

Switches and push buttons with indicator lamp

Connection examples

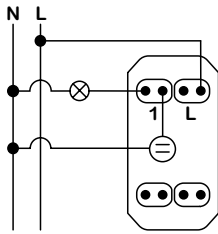

1-module - One-way switch with indicator lamp

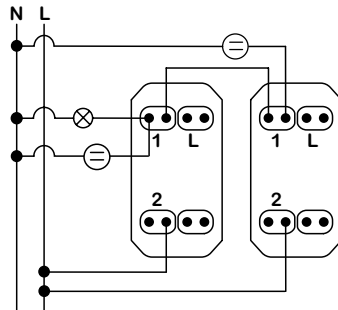

1-module - 2 two-way switches with indicator lamp

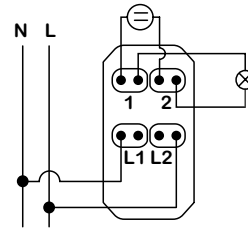

Double pole switch with indicator lamp

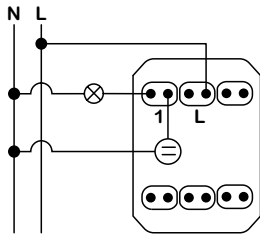

2-module - One-way switch with indicator lamp

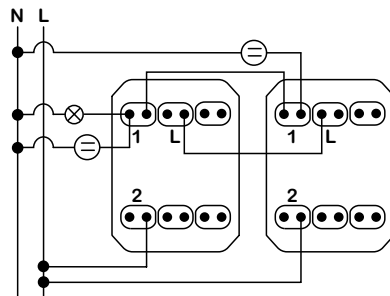

2-module - 2 two-way switches with indicator lamp

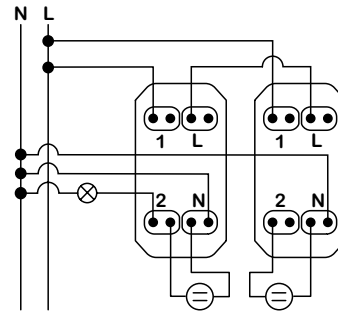

1-module - 2 two-way switches with indicator lamp and neutral connection

Unica

Connections

Switches

Switches and push buttons with locator lamp

Connection examples

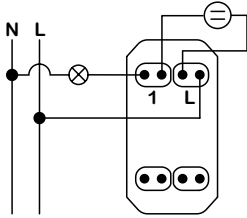

1-module - One-way switch and push button with locator lamp

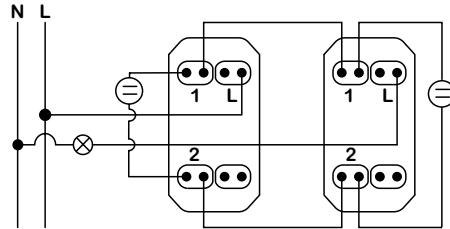

1-module - 2 two-way switches with locator lamp

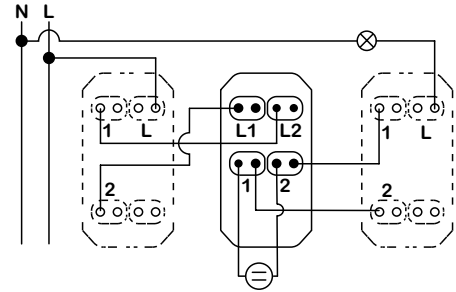

1-module - 2 two-way switches + 1 intermediate with locator lamp

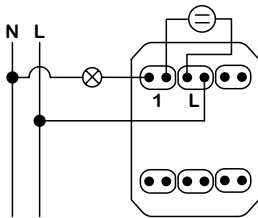

2-module - One-way switch with locator lamp

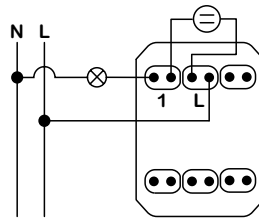

2-module - Push button with locator lamp

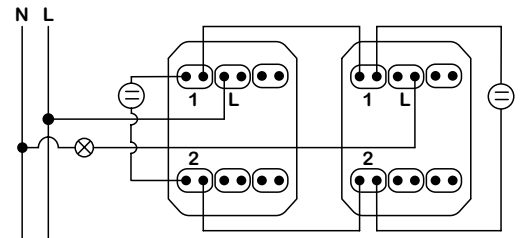

2-module - Two way switch with locator lamp

Room control

Room control unit and lamp and bell push button

A: NU5217●● and B: NU5777●●

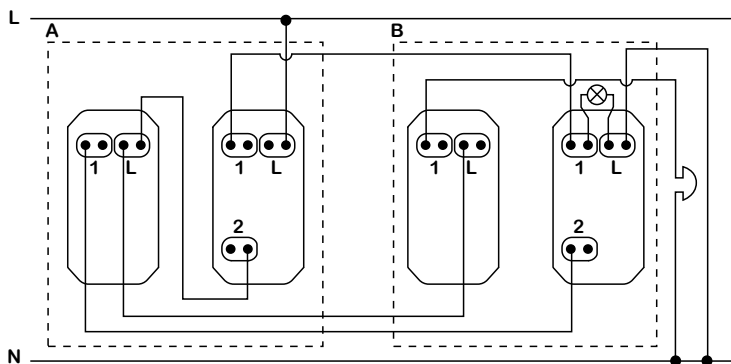

Control unit and lamp and bell push button connection for room indication.

Unica

Connections

Comfort devices

Universal rotary dimmer LED

NU35141●●

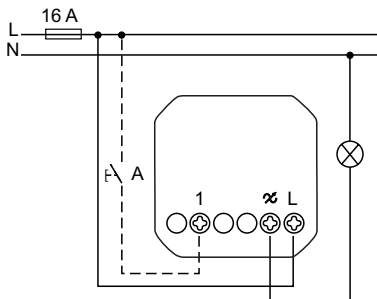

Controlling blinds locally

Motion sensor 10 A

NU3525●●

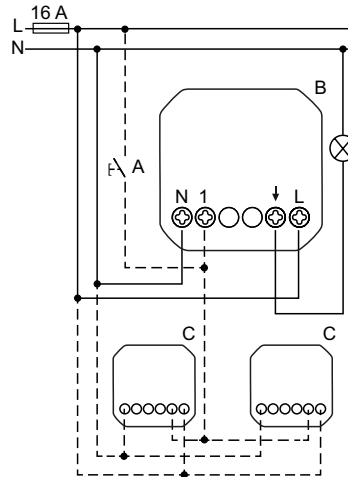

Detection moving heat sources
(e.g. persons)

Timer 10 A

NU3535●●

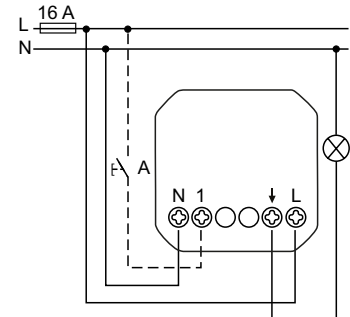

Manual switching off or restarting
the overtravel time with an activated
overtravel time

Floor thermostats 10 A

NU3503●●

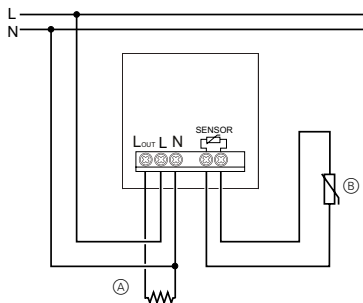

Room thermostats 8 A

NU3501●●

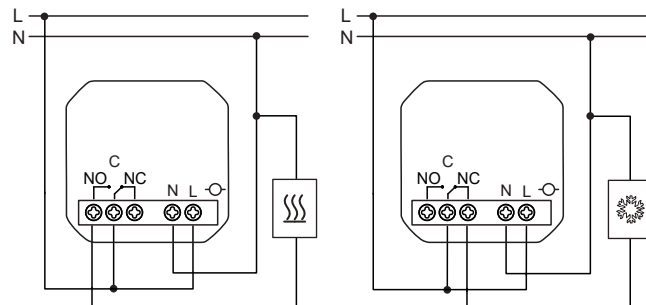

Electronic card switch 8 A

NU3540●●

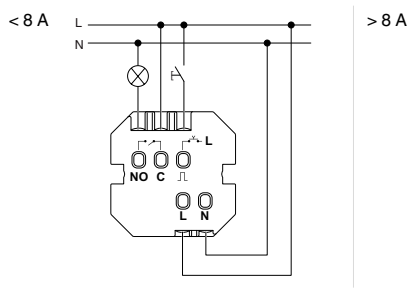

Multistandard socket outlet

NU3085●●
NU3084●●

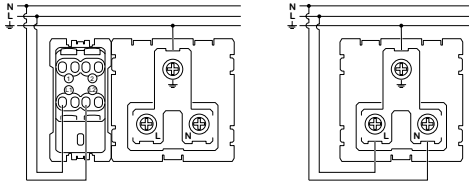

Plug compatibility table



	Standard	Plug type	Nominal voltage/ current
1	Europlug	2P	250 V / 2,5 A
2	Argentinean / Australian	2P + E	250 V / 10 A
3	USA	2P + E	127 V / 15 A
4	British	2P + E	250 V / 13 A
5	Indian	2P + E	250 V / 6 A
6	Chinese	2P + E	250 V / 10 A



⚠ DANGER

The multistandard socket is not suitable for German and French 2P + E sockets as they do not provide ground continuity.

A residual current circuit protection with a sensitivity of 30 mA must be installed for this product.

Surge protected socket outlet

NU3059●●EP

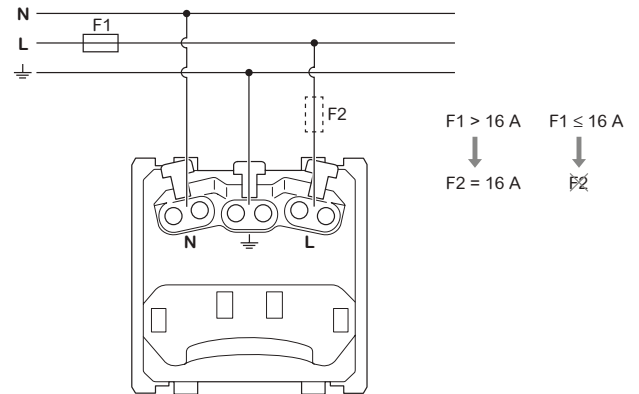
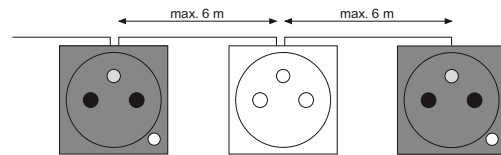
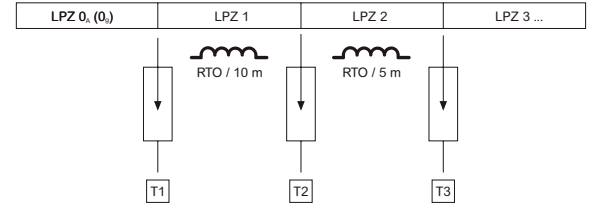

Wiser blind control switch

NU3508●●
NU3509●●

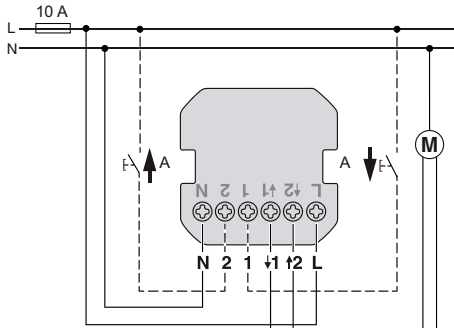

Wiser motion sensor 10 A

NU3526●●

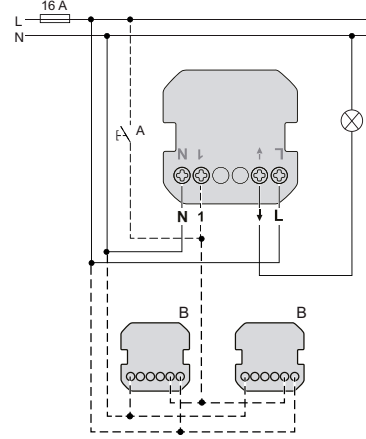

Wiser motion sensor with universal push button dimmer LED

NU3527●●

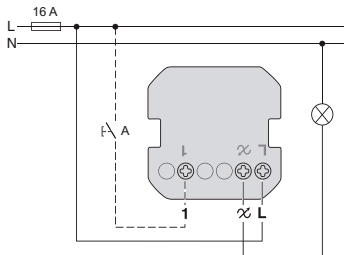

Wiser relay switch 10 A

NU3537●●
NU3538●●

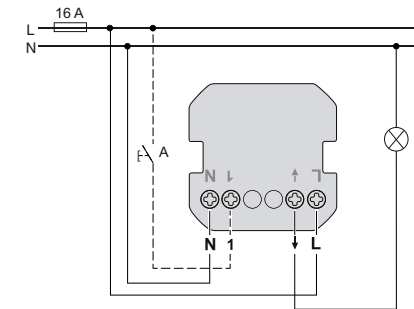

Wiser universal push button dimmer LED

NU3515●●
NU3517●●

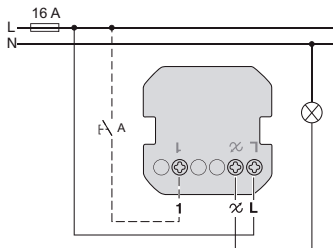

Wiser universal rotary dimmer LED

NU3516●●
NU3518●●

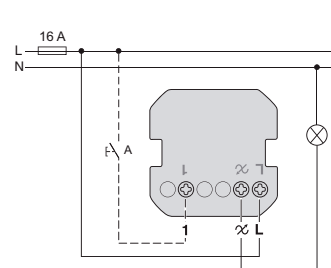





Connections

Data / Phone / TV

USB data connector

NU3429●●



1	Vbus 5 V DC	
2	D-	
3	D+	
4	GND	
5	\perp	

Unica

Connections

USB chargers

USB Chargers

Type A: **NU3428** (1-module) - **NU3418** (2-module)

Type A + C : **NU3018** (2-module)

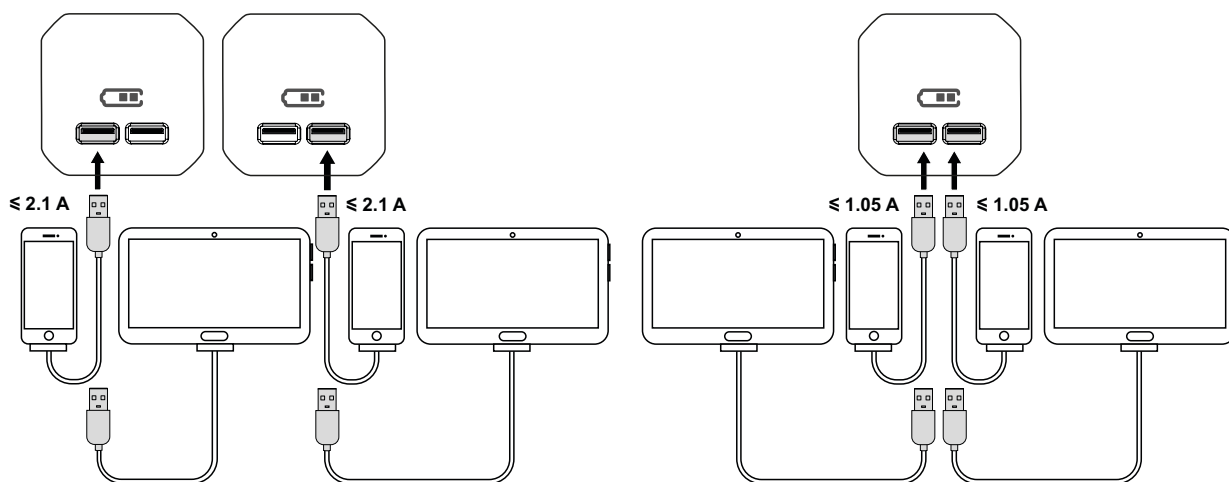
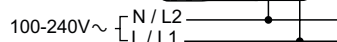
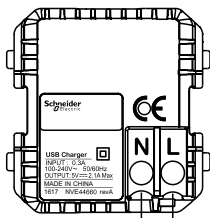

USB Type A connection

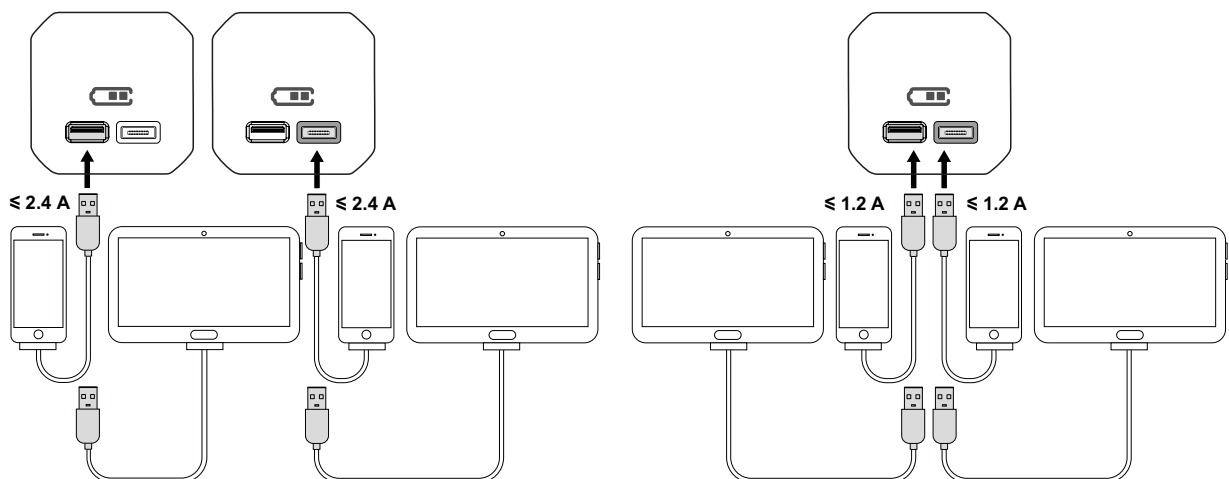

USB Type A + C connection

Unica

Connections

Other functions

Bed side lamp

NU3603●●

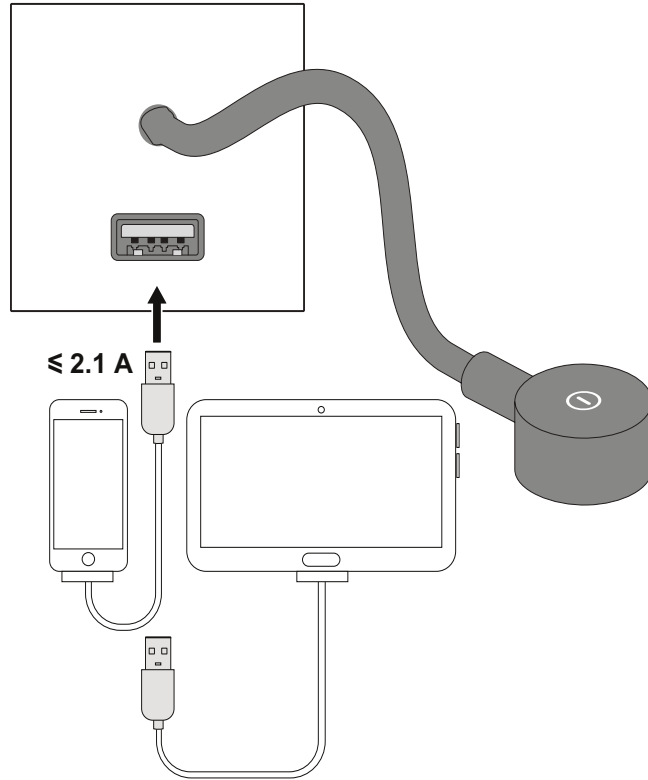
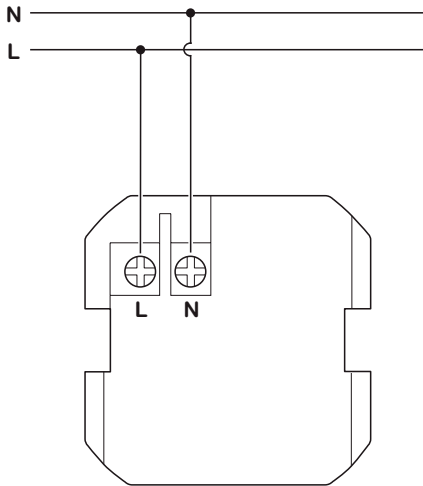
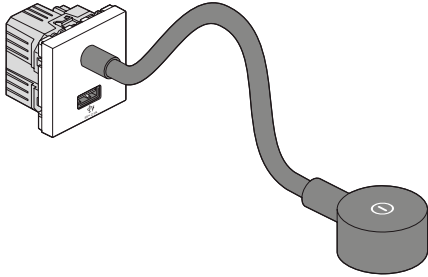

USB Type A connection

Unica

Connections

Other functions

Electronic door bell

NU3786●●

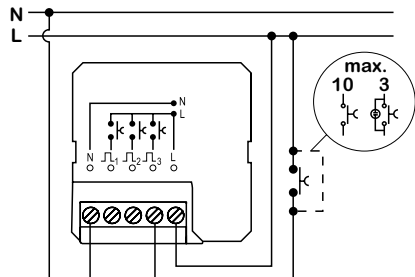

Manual switching off or restarting the overtravel time with an activated overtravel time

Volume control

NU3602●●

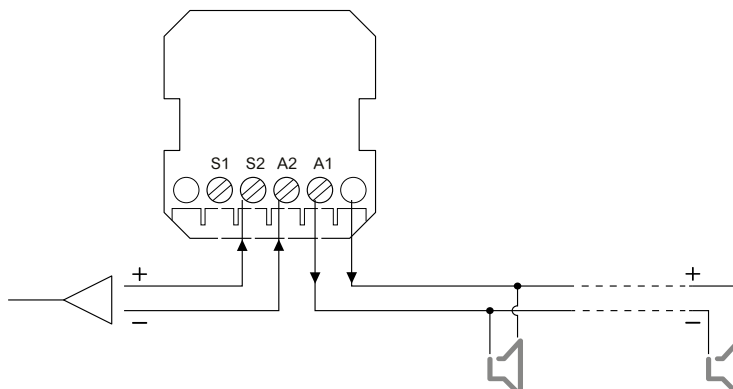

Bluetooth receiver

NU3601●●

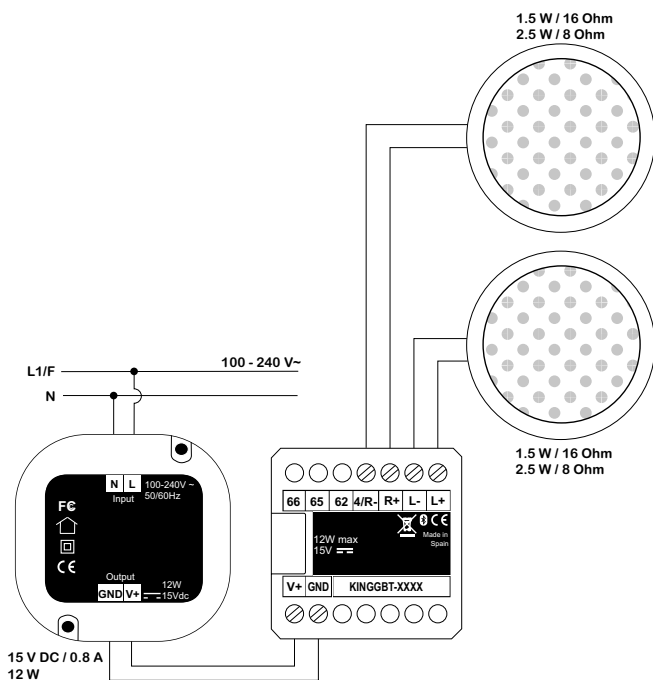

Connections

RJ45 data sockets

Installation

Example of unshielded punch down data socket installation.

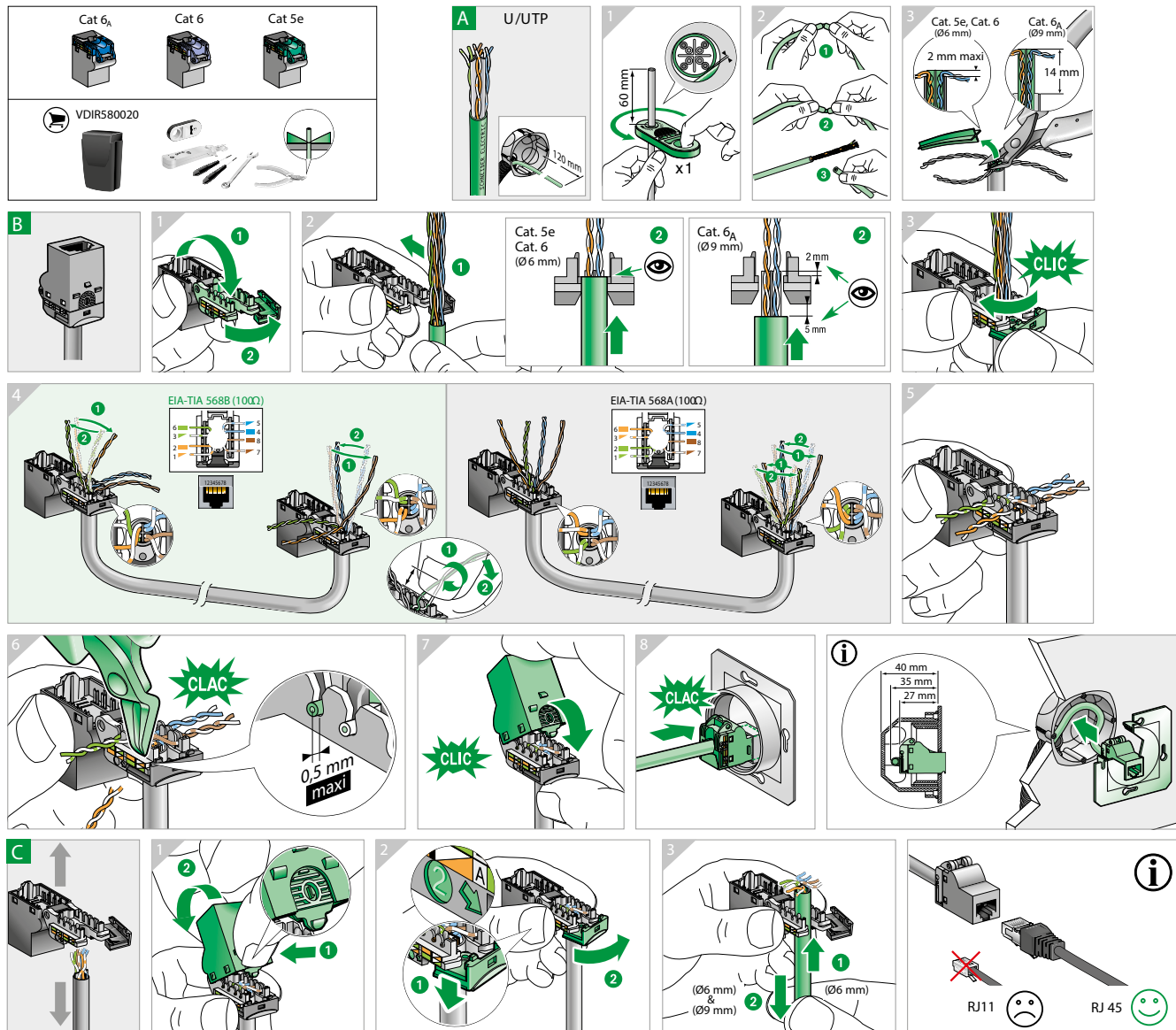

Technical data

Categories

- a. The most important property defining a data network is the speed at which information can circulate inside this network.
- b. According to this aspect, installations are classed into the following categories:

Category	Transmission rate	Network type
Cat. 3	Up to 10 MHz	Ethernet 10 Base T, Token Ring 4 Mbps
Cat. 4	Up to 16 MHz	Token Ring 16 Mbps
Cat. 5 _E	Up to 100 MHz	Ethernet 1000 Base T, ATM 155 Mbps
Cat. 6	Up to 250 MHz	Ethernet 1000 Base T, ATM 1200
Cat. 6 _A	Up to 500 MHz	Ethernet full-duplex mode 1000 Base T

Connections

RJ45 data sockets

Installation

Example of unshielded punch down data socket installation.

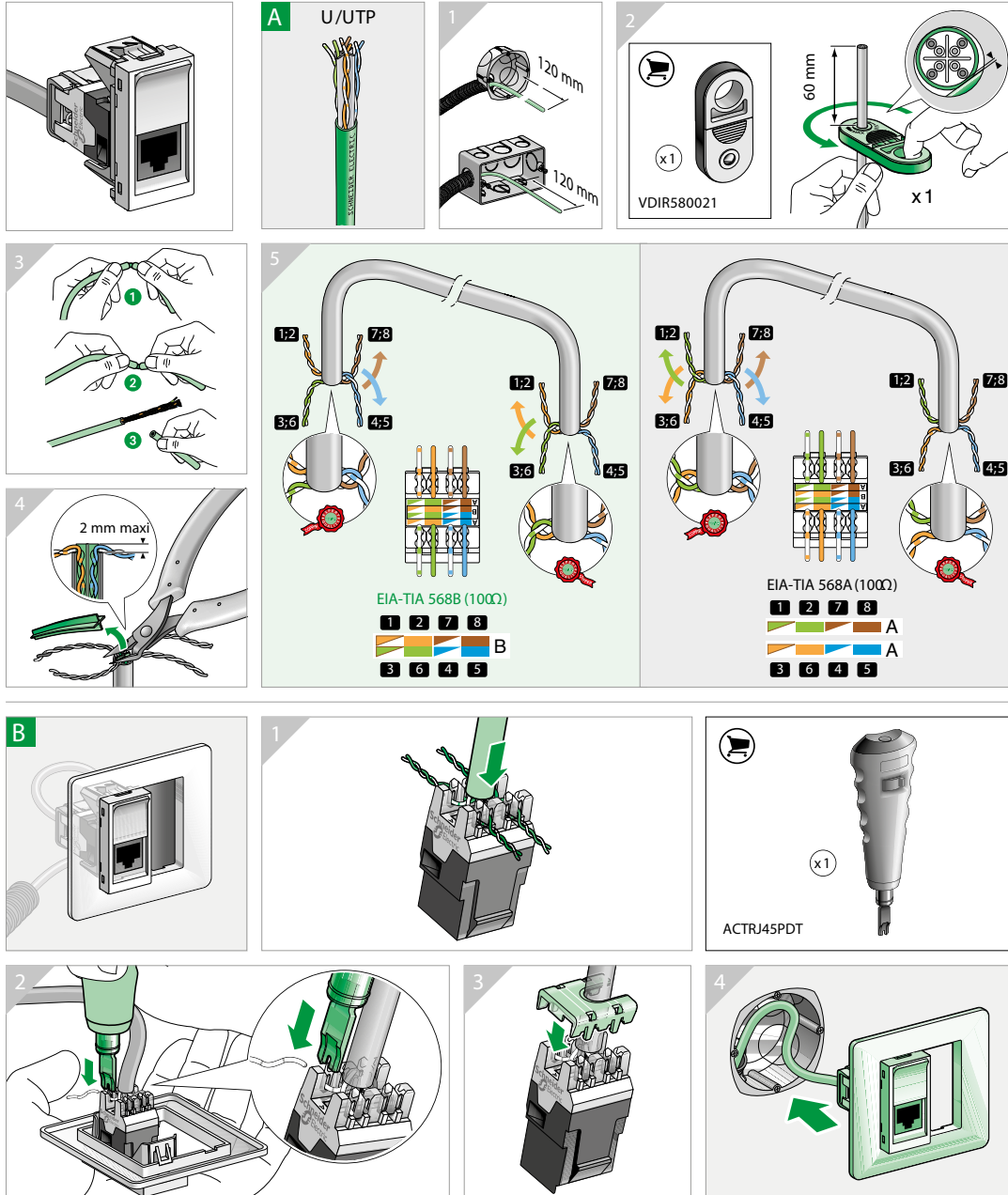

Unica Index

Reference number overview

Ref.	Pg.	Ref.	Pg.	Ref.	Pg.	Ref.	Pg.	Ref.	Pg.
A		NU7002G	110	NU121854	150	NU206544	78	NU270328	117
ALB45032	73	NU7002P	110	NU122418	150	NU206554	78	NU270344	117
ALB45033	73	NU7002PC	110	NU122420	146	NU206718	76, 94	NU270350M	118
ALB45290	79	NU7002PCP	110	NU122430	150	NU206730	76, 94	NU270351M	118
C		NU7002PG	110	NU122454	150	NU206744	76, 94	NU270352M	118
CCT90501	74, 93, 124, 127, 139	NU7004PC	110	NU123418	150	NU206754	76, 94	NU270353M	118
I		NU7006C	110	NU123420	146	NU210118	117	NU270355M	118
IMT35914	112	NU7008C	110	NU123430	150	NU210130	117	NU270356M	118
IMT35915	112	NU7103	110	NU123454	150	NU210144	117	NU270357M	118
IMT35924	112	NU7103P	110	NU124418	150	NU210154	117	NU270358M	118
IMT35934	112	NU7104	110	NU124420	146	NU210218	117	NU270359M	118
IMT35935	112	NU7104P	110	NU124430	150	NU210230	117	NU270360M	118
IMT35944	112	NU7107	110	NU124454	150	NU210244	117	NU270362M	118
IMT35945	112	NU7204P	153	NU171020	146, 150	NU210254	117	NU270411	117
IMT35994	112	NU7802	111	NU171054	150	NU210318	117	NU270412	117
IMT35995	112	NU7892	111	NU171820	146, 150	NU210330	117	NU270413	117
M		NU8710	151	NU171854	150	NU210344	117	NU270414	117
MGU5.064.18	79, 94	NU8718	151	NU172418	150	NU210354	117	NU270416	117
MGU8.601	112	NU8724	152	NU172430	150	NU210418	117	NU270417	117
MGU8.603	112	NU8734	152	NU172454	150	NU210430	117	NU270418	117
MGU8.604	112	NU8744	152	NU173418	150	NU210444	117	NU270421	117
MT35925	112	NU9091	79	NU173420	146	NU210454	117	NU270422	117
MUR34101	120	NU9580	111	NU173430	150	NU210718	117	NU270424	117
MUR34107	120	NU9800	153	NU173454	150	NU210730	117	NU270426	117
MUR34108	120	NU9801	153	NU174418	150	NU210744	117	NU270427	117
MUR34109	120	NU9802	153	NU174430	150	NU210754	117	NU270428	117
MUR34151	120	NU9823AM	71, 91, 101, 106, 137	NU174454	150	NU230001	119	NU270444	117
MUR35110	120	NU9825A	71, 91, 101, 106, 137	NU200118	120	NU230013	119	NU270450M	118
MUR37713	120	NU9825AZ	71, 91, 101, 106, 137	NU200130	120	NU230014	119	NU270451M	118
MUR37911	120	NU021020	146, 151	NU200154	120	NU230016	119	NU270452M	118
MUR37912	120	NU021030	151	NU200218	117	NU230018	119	NU270453M	118
MUR37914	120	NU021054	151	NU200230	117	NU230024	119	NU270455M	118
MUR39101	120	NU021820	146, 151	NU200244	117	NU230030	119	NU270456M	118
MUR39107	120	NU021830	151	NU200254	117	NU230031	119	NU270457M	118
MUR39108	120	NU021854	151	NU200418	117	NU230044	119	NU270458M	118
MUR39109	120	NU022418	152	NU200430	117	NU230054	119	NU270459M	118
MUR39110	120	NU023418	152	NU200444	117	NU230218	119	NU270460M	118
MUR39151	120	NU024418	152	NU200454	117	NU230418	119	NU270462M	118
MUR39911	120	NU044218	120	NU200618	117	NU230618	119	NU270711	117
MUR39912	120	NU055318	120	NU200630	117	NU230818	119	NU270712	117
MUR39913	120	NU055344	120	NU200644	117	NU231018	119	NU270713	117
MUR39914	120	NU055418	120	NU200654	117	NU270311	117	NU270714	117
N		NU112118	152	NU200818	117	NU270312	117	NU270716	117
NU3488	85	NU113118	152	NU200830	117	NU270313	117	NU270717	117
NU003718	76, 107	NU114118	152	NU200844	117	NU270314	117	NU270718	117
NU003744	76, 107	NU121020	146, 150	NU200854	117	NU270315	117	NU270721	117
NU3772	85	NU121054	150	NU201018	117	NU270316	117	NU270722	117
NU3773	85	NU121820	146, 150	NU201030	117	NU270317	117	NU270724	117
NU3774	85	NU121830	150	NU201044	117	NU270318	117	NU270726	117
NU3775	85			NU201054	117	NU270321	117	NU270727	117
NU3776	85			NU203718	94, 107	NU270322	117	NU270728	117
NU7002	110			NU206318	78, 94	NU270324	117	NU270750M	118
NU7002C	110			NU206518	78	NU270326	117	NU270751M	118
				NU206530	78	NU270327	117	NU270752M	118

Reference number overview

Ref.	Pg.	Ref.	Pg.	Ref.	Pg.	Ref.	Pg.	Ref.	Pg.
NU270753M	118	NU280460M	118	NU301554	77, 80	NU303930E	77	NU305930	77
NU270755M	118	NU280462M	118	NU301554E	80	NU303944E	77	NU305930E	77
NU270756M	118	NU280611	117	NU301618	80	NU303954	77	NU305930EP	77
NU270757M	118	NU280613	117	NU301630	80	NU303954E	77	NU305944E	77
NU270758M	118	NU280614	117	NU301644	80	NU304118	78	NU305954	77
NU270759M	118	NU280616	117	NU301654	80	NU304130	78	NU305954E	77
NU270760M	118	NU280617	117	NU301718	76, 80	NU304154	78	NU305954EP	77
NU270762M	118	NU280618	117	NU301730	76, 80	NU304518	78	NU305961	77
NU280211	117	NU280621	117	NU301744	76, 80	NU304530	78	NU306018	78
NU280213	117	NU280622	117	NU301754	76, 80	NU304544	78	NU306030	78
NU280214	117	NU280624	117	NU301818	80	NU304554	78	NU306054	78
NU280216	117	NU280626	117	NU301830	80	NU304703	79	NU306103	77, 140
NU280217	117	NU280627	117	NU301854	80	NU304718	79	NU306103S	77, 140
NU280218	117	NU280628	117	NU301918	80	NU304730	79	NU306103T	87, 140
NU280221	117	NU280644	117	NU301930	80	NU304744	79	NU306603	76
NU280222	117	NU280650M	118	NU301954	80	NU304754	79	NU306618	76
NU280224	117	NU280651M	118	NU302018	78	NU304903	77, 140	NU306630	76
NU280226	117	NU280652M	118	NU302044	78	NU304903T	87, 140	NU306654	76
NU280227	117	NU280653M	118	NU302118	78	NU304906	77, 140	NU306703	76
NU280228	117	NU280655M	118	NU302130	78	NU304918	77	NU306703A	76
NU280244	117	NU280656M	118	NU302144	78	NU304918T	87	NU306703AS	76
NU280250M	118	NU280657M	118	NU302154	78	NU304920	140	NU306703S	76
NU280251M	118	NU280658M	118	NU302318	78	NU304954	77	NU306706AS	76
NU280252M	118	NU280659M	118	NU302330	78	NU305103	77, 140	NU306718	76
NU280253M	118	NU280660M	118	NU302344	78	NU305103T	87, 140	NU306718A	76
NU280255M	118	NU280662M	118	NU302354	78	NU305118	77	NU306718AS	76
NU280256M	118	NU280811	117	NU302818	78	NU305203	77, 140	NU306718S	76
NU280257M	118	NU280813	117	NU302830	78	NU305203T	87, 140	NU306720A	141
NU280258M	118	NU280814	117	NU302854	78	NU305206	77, 140	NU306730A	76
NU280259M	118	NU280816	117	NU303118	78	NU305218	77	NU306730AS	76
NU280260M	118	NU280817	117	NU303130	78	NU305218E	77	NU306754A	76
NU280262M	118	NU280818	117	NU303144	78	NU305218P	77	NU306754AS	76
NU280411	117	NU280821	117	NU303154	78	NU305218T	87	NU306761AS	76
NU280413	117	NU280822	117	NU303318	78	NU305220	140	NU306903	77, 140
NU280414	117	NU280824	117	NU303344	78	NU305230	77	NU306903S	77, 140
NU280416	117	NU280826	117	NU303354	78	NU305230E	77	NU306903SE	77
NU280417	117	NU280827	117	NU303618	76	NU305244E	77	NU306903T	87, 140
NU280418	117	NU280828	117	NU303644	76	NU305254	77	NU306906	77, 140
NU280421	117	NU280844	117	NU303703	76	NU305254E	77	NU306918	77
NU280422	117	NU280850M	118	NU303706	76	NU305703	76	NU306918S	77
NU280424	117	NU280851M	118	NU303718	76	NU305718	76	NU306918T	87
NU280426	117	NU280852M	118	NU303718TA	76	NU305720	141	NU306930	77
NU280427	117	NU280853M	118	NU303720	141	NU305730	76	NU306954	77
NU280428	117	NU280855M	118	NU303730	76	NU305744	76	NU306954S	77
NU280444	117	NU280856M	118	NU303730TA	76	NU305754	76	NU307103	77, 140
NU280450M	118	NU280857M	118	NU303744	76	NU305903	77, 140	NU307103T	87, 140
NU280451M	118	NU280858M	118	NU303744TA	76	NU305903T	87, 140	NU307603	76
NU280452M	118	NU280859M	118	NU303754	76	NU305906	77, 140	NU307618	76
NU280453M	118	NU280860M	118	NU303754TA	76	NU305918	77	NU307630	76
NU280455M	118	NU280862M	118	NU303761	76	NU305918E	77	NU307903	77, 140
NU280456M	118	NU301518	77, 80	NU303903E	77	NU305918EP	77	NU307903T	87, 140
NU280457M	118	NU301518E	80	NU303918	77	NU305918P	77	NU307906	77, 140
NU280458M	118	NU301530	77, 80	NU303918E	77	NU305920	140	NU307918	77
NU280459M	118	NU301530E	80	NU303930	77	NU305920T	87	NU307918T	87

Reference number overview

Ref.	Pg.	Ref.	Pg.	Ref.	Pg.	Ref.	Pg.	Ref.	Pg.
NU307930	77	NU310830SC	72	NU320620N	136	NU326118N	70	NU342618	81
NU307954	77	NU310844SC	72	NU320630	69	NU326144	70	NU342630	81
NU308418	79	NU310854SC	72	NU320630CN	69	NU326218	70	NU342654	81
NU308430	79	NU310918SC	72	NU320630LN	69	NU326218S	70	NU342918	83
NU308454	79	NU310944SC	72	NU320630N	69	NU326230	70	NU342930	83
NU308518	79	NU312718SC	72	NU320644	69	NU326230S	70	NU342954	83
NU308818	79	NU312744SC	72	NU320644CN	69	NU326254	70	NU343018	83
NU309818	79	NU313618	69	NU320644N	69	NU326254S	70	NU343030	83
NU309830	79	NU313630	69	NU320654	69	NU326318	70	NU343044	83
NU310118	68	NU313654	69	NU320654CN	69	NU326330	70	NU343054	83
NU310118SC	68	NU316118	70	NU320654L	69	NU326354	70	NU343118	83
NU310118SMUR	68	NU316118S	70	NU320654LN	69	NU328118	70	NU343154	83
NU310120	136	NU316130	70	NU320654N	69	NU328318	73	NU343218	83
NU310130	68	NU316144	70	NU320718	72	NU328330	73	NU343254	83
NU310144	68	NU316154	70	NU320730	72	NU328344	73	NU343318	83
NU310144SC	68	NU316218	70	NU320744	72	NU328354	73	NU343330	83
NU310154	68	NU316218S	70	NU320754	72	NU340618	81	NU343354	83
NU310318	68	NU316318	70	NU320818	72	NU341018	81	NU344718	81
NU310318F	68	NU316354	70	NU320820	138	NU341030	81	NU344754	81
NU310318S	68	NU320118	68	NU320830	72	NU341044	81	NU344818	81
NU310318SC	68	NU320118SC	68	NU320844	72	NU341054	81	NU344830	81
NU310318SDND	68	NU320120	136	NU320854	72	NU341118	81	NU344844	81
NU310320	136	NU320130	68	NU321118	68	NU341130	81	NU344854	81
NU310330	68	NU320144	68	NU321130	68	NU341144	81	NU344918	81
NU310330S	68	NU320144SC	68	NU321144	68	NU341154	81	NU344930	81
NU310344	68	NU320154	68	NU321154	68	NU341218	81	NU344954	81
NU310344SC	68	NU320318	68	NU321318	68	NU341318	81	NU345018	84
NU310354	68	NU320318F	68	NU321318F	68	NU341418	81	NU345020	142
NU310354S	68	NU320318P	68	NU321330	68	NU341430	81	NU345030	84
NU310518	68	NU320318S	68	NU321344	68	NU341444	81	NU345044	84
NU310518SC	68	NU320320	136	NU321354	68	NU341454	81	NU345054	84
NU310520	136	NU320320VMC	138	NU321418	72	NU341518	81	NU345118	84
NU310530	68	NU320330	68	NU321430	72	NU341530	81	NU345130	84
NU310544	68	NU320330S	68	NU321454	72	NU341544	81	NU345144	84
NU310554	68	NU320330VMC	138	NU322518	70	NU341554	81	NU345154	84
NU310618	69	NU320344	68	NU322620	72, 138	NU341618	81	NU345218	84
NU310618CN	69	NU320354	68	NU322630	72	NU341630	81	NU345230	84
NU310618F	69	NU320354S	68	NU322644	72	NU341644	81	NU345254	84
NU310618N	69	NU320354VMC	138	NU322654	72	NU341654	81	NU345318	84
NU310618NSC	69	NU320518	68	NU323218S	70	NU341718	81	NU345418	84
NU310618SC	69	NU320520	136	NU323230S	70	NU341730	81	NU345430	84
NU310620	136	NU320530	68	NU323244S	70	NU341754	81	NU345444	84
NU310630	69	NU320544	68	NU323254S	70	NU341818	80	NU345454	84
NU310630N	69	NU320554	68	NU323618	69	NU341830	80	NU345518	84
NU310644	69	NU320618	69	NU323630	69	NU341844	80	NU345554	84
NU310644NSC	69	NU320618C	69	NU323654	69	NU341854	80	NU345618	84
NU310654	69	NU320618CN	69	NU323718	72	NU341918	81	NU346118	84
NU310654N	69	NU320618F	69	NU323730	72	NU341918P	81	NU346120	142
NU310718SC	72	NU320618FN	69	NU323754	72	NU341930	81	NU346130	84
NU310730SC	72	NU320618L	69	NU324620	69, 136	NU341954	81	NU346154	84
NU310744SC	72	NU320618LN	69	NU324630	69	NU342018	81	NU346218	84
NU310754SC	72	NU320618N	69	NU324654	69	NU342030	81	NU346220	142
NU310818SC	72	NU320620	136	NU326118	70	NU342054	81	NU346230	84

Reference number overview

Ref.	Pg.	Ref.	Pg.	Ref.	Pg.	Ref.	Pg.	Ref.	Pg.
NU346244	84	NU351718	124	NU400218	119	NU503654	94	NU521144Z	100
NU346254	84	NU351730	124	NU400218P	119	NU503718	94	NU521154	90
NU346818	84	NU351754	124	NU400220	145	NU503718TA	94	NU521154N	90
NU346830	84	NU351818	124	NU400230	119	NU503718Z	102	NU521318	90
NU346844	84	NU351830	124	NU400254	119	NU503730	94	NU521330	90
NU346854	84	NU351854	124	NU400418	119	NU503730TA	94	NU521344	90
NU347918	81	NU352518	75	NU400420	145	NU503744TA	94	NU521354	90
NU348218	81	NU352530	75	NU400430	119	NU503754	94	NU521518	90
NU348418	81	NU352554	75	NU400454	119	NU503754TA	94	NU521530	90
NU348518	81	NU352618	125	NU400618	119	NU505618	94	NU521544	90
NU348618	85	NU352630	125	NU400620	145	NU505630	94	NU521554	90
NU348630	85	NU352654	125	NU400630	119	NU505644	94	NU521718	90
NU348644	85	NU352718	125	NU400654	119	NU505654	94	NU521730	90
NU348654	85	NU352730	125	NU400818	119	NU505718	94	NU521754	90
NU348718	85	NU352754	125	NU400830	119	NU505730	94	NU528218	68, 90
NU348730	85	NU353518	75	NU400854	119	NU505744	94	NU528230	68, 90
NU348744	85	NU353530	75	NU400918	78	NU505754	94	NU528244	68, 90
NU348754	85	NU353554	75	NU400954	78	NU508218	76, 94	NU528254	68, 90
NU349118	83	NU353718W	127	NU411018	119	NU508230	76, 94	NU541118	96
NU349130	83	NU353730W	127	NU411030	119	NU508244	76, 94	NU541118Z	103
NU349144	83	NU353754W	127	NU411054	119	NU508254	76, 94	NU541130	96
NU349154	83	NU353818	124	NU411418	119	NU520118	90	NU541144	96
NU349618	83	NU353830	124	NU411420	145	NU520118N	90	NU541144Z	103
NU349654	83	NU353854	124	NU411430	119	NU520118NZ	100	NU541154	96
NU349718	83	NU354018	75	NU411454	119	NU520118Z	100	NU541518	96
NU349730	83	NU354054	75	NU411618	119	NU520144	90	NU541530	96
NU349744	83	NU360118	85	NU411620	145	NU520144Z	100	NU541544	96
NU349918	83	NU360154	85	NU411630	119	NU520154	90	NU541554	96
NU349930	83	NU360218	85	NU411654	119	NU520154N	90	NU541818	95
NU349944	83	NU360230	85	NU411818	119	NU520318	90	NU541854	95
NU349954	83	NU360254	85	NU411830	119	NU520318NZ	100	NU542018	96
NU350118	74	NU360318	86	NU411854	119	NU520318Z	100	NU542054	96
NU350130	74	NU360330	86	NU501318	80, 95	NU520344	90	NU542418	96
NU350144	74	NU360344	86	NU501330	80, 95	NU520344Z	100	NU542454	96
NU350154	74	NU360354	86	NU501344	80	NU520354	90	NU543018	96
NU350318	74	NU360518	86	NU501354	80, 95	NU520354N	90	NU543054	96
NU350330	74	NU363118	86	NU501418	80, 95	NU520518	90	NU545718	84
NU350344	74	NU370118	72	NU501430	80, 95	NU520518N	90	NU545754	84
NU350354	74	NU373118	72	NU501444	80	NU520518Z	100	NU546218	96
NU350818W	127	NU373130	72	NU501454	80, 95	NU520554	90	NU546218Z	103
NU350830W	127	NU373154	72	NU501818	95	NU520618	90	NU546244	96
NU350854W	127	NU378518	85	NU501830	95	NU520618Z	100	NU546244Z	103
NU350918	125	NU378530	85	NU501844	95	NU520644Z	100	NU546254	96
NU350930	125	NU378544	85	NU501854	95	NU520718	92	NU546318	96
NU350954	125	NU378554	85	NU503318	94	NU520754	92	NU546418	96
NU351418	74	NU378618	85	NU503330	94	NU520818	92	NU546454	96
NU351420	139	NU378630	85	NU503344	94	NU521118	90	NU550118	93
NU351430	74	NU378644	85	NU503354	94	NU521118N	90	NU550318	93
NU351454	74	NU378654	85	NU503618	94	NU521118NZ	100	NU550330	93
NU351518W	127	NU386218	86	NU503618Z	102	NU521118Z	100	NU550344	93
NU351554W	127	NU386230	86	NU503630	94	NU521130	90	NU550354	93
NU351618W	127	NU386244	86	NU503644	94	NU521130N	90	NU551444	93
NU351654W	127	NU386254	86	NU503644Z	102	NU521144	90	NU551454	93

Reference number overview

Ref.	Pg.	Ref.	Pg.	Ref.	Pg.	Ref.	Pg.
NU551718	124	NU600618	116	NU840654	112	NU943954	82
NU551730	124	NU600624	116	NU903718U	79, 94, 102	NU944018	84, 96
NU551744	124	NU600626	116	NU903744	79, 94, 102	NU944054	84, 96
NU551754	124	NU600630	116	NU910018	71, 91, 101, 106	NU944118	84, 96
NU553018	132	NU600640	116	NU910018N	71, 91, 101, 106	NU944130	84, 96
NU553030	132	NU600641	116	NU910020	137	NU944154	84, 96
NU553054	132	NU600642	116	NU910020N	137	NU946018	82
NU553118	132	NU600643	116	NU910030	71, 91, 101, 106	NU946020	142
NU553130	132	NU600654	116	NU910030N	71, 91, 101, 106	NU946030	82
NU553154	132	NU600671	116	NU910044	71, 91, 101, 106	NU946054	82
NU555718	126	NU600672	116	NU910054	71, 91, 101, 106	NU946118	82
NU555730	126	NU600674	116	NU910054N	71, 91, 101, 106	NU946120	142
NU555754	126	NU600677	116	NU920018	71, 91, 101, 106	NU946130	82
NU555918	128	NU600679	116	NU920018N	71, 91, 101, 106	NU946154	82
NU555954	128	NU600818	116	NU920020	137	NU946218	82
NU557118W	128	NU600824	116	NU920020N	137	NU946230	82
NU557120W	144	NU600826	116	NU920030	71, 91, 101, 106	NU946254	82
NU557130W	128	NU600830	116	NU920030N	71, 91, 101, 106	NU946318	82
NU557154W	128	NU600840	116	NU920044	71, 91, 101, 106	NU946330	82
NU577718	97	NU600841	116	NU920044N	71, 91, 101, 106	NU946354	82
NU577730	97	NU600842	116	NU940618	82	NU946418	82
NU577754	97	NU600843	116	NU940620	142	NU946454	82
NU586218	97	NU600854	116	NU940654	82	NU947818	82
NU586254	97	NU600871	116	NU940718	82	NU947830	82
NU586618	97	NU600872	116	NU940720	142	NU947918	82
NU600218	116	NU600874	116	NU940754	82	NU947930	82
NU600224	116	NU600877	116	NU941018	82	NU986418	86
NU600226	116	NU600879	116	NU941020	142	NU986430	86
NU600230	116	NU601018	116	NU941054	82	NU986444	86
NU600240	116	NU601030	116	NU941118	82	NU986454	86
NU600241	116	NU601054	116	NU941118T	87	NU986518	86
NU600242	116	NU800218	112	NU941120	142	NU986520	143
NU600243	116	NU800244	112	NU941130	82	NU986530	86
NU600254	116	NU800418	112	NU941154	82	NU986544	86
NU600271	116	NU800444	112	NU942018	82	NU986554	86
NU600272	116	NU800618	112	NU942020	142	NU986618	86
NU600274	116	NU800644	112	NU942054	82	NU986620	143
NU600277	116	NU810318	112	NU942218	82	NU986630	86
NU600279	116	NU810418	112	NU942254	82	NU986644	86
NU600418	116	NU821020	146, 151	NU942418	82	NU986654	86
NU600424	116	NU821030	151	NU943818	82	S	
NU600426	116	NU821054	151	NU943854	82	S520299	71, 91, 101, 106, 137
NU600430	116	NU821820	146, 151	NU943918	82	U	
NU600440	116	NU821830	151			U0.582	111
NU600441	116	NU821854	151				
NU600442	116	NU822418	152				
NU600443	116	NU823418	152				
NU600454	116	NU824418	152				
NU600471	116	NU840218	112				
NU600472	116	NU840254	112				
NU600474	116	NU840418	112				
NU600477	116	NU840454	112				
NU600479	116	NU840618	112				



Environmental Data Program

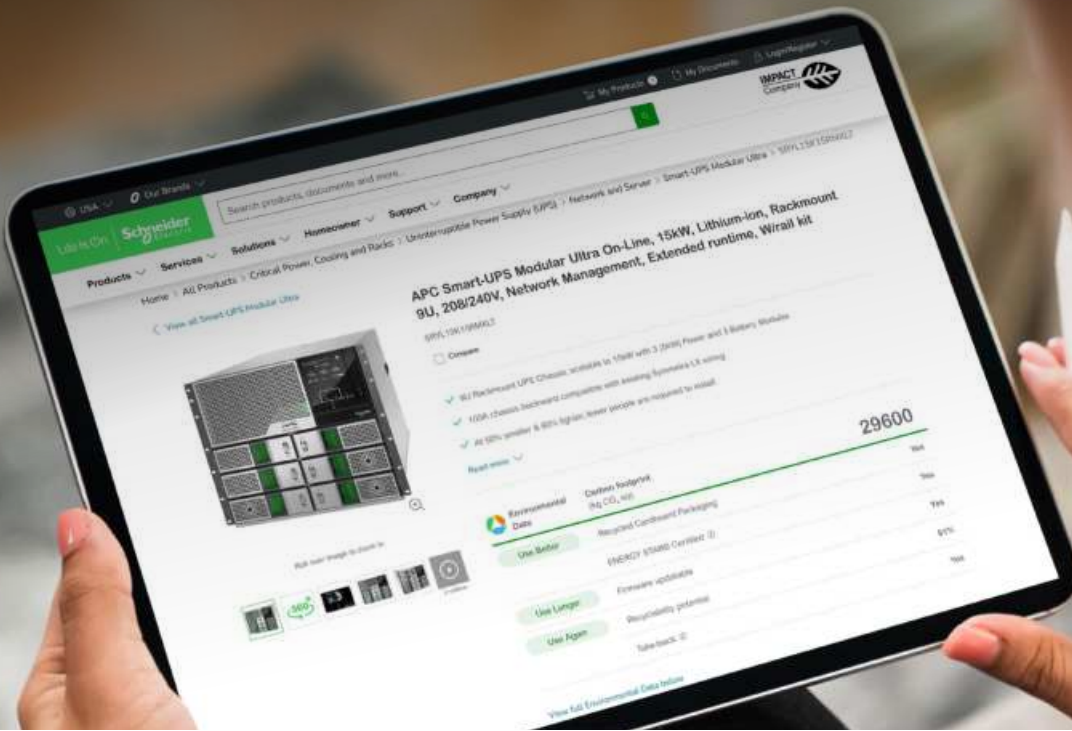

Next-level transparency for better-informed product choices

The Environmental Data Program is a framework for how we measure, categorize, and compare the environmental attributes and footprint of our products.

Using a rigorous, fact-based methodology, the program provides environmental data from across the product lifecycle.

Five data categories across the product lifecycle

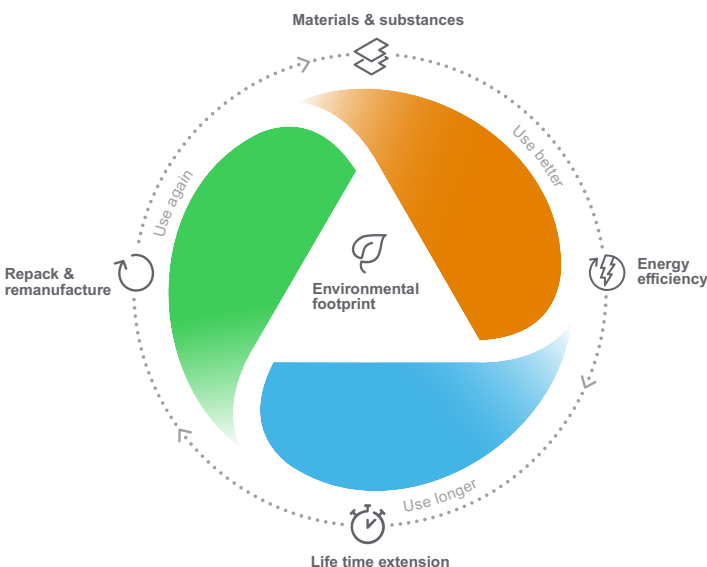

Use Better: How sustainable a product is, including environmental footprint, materials and substances, packaging, and energy efficiency.

Use Longer: How a product's life time can be effectively extended in terms of repairability and updatability.

Use Again: How a product can be reused, from dismantling and remanufacturing to recyclability and manufacturer take back.

With this transparent, verified data, customers and partners are empowered to make conscious environmental choices and accurately evaluate and report on sustainability performance.

All our hardware offers have an associated environmental data available on se.com product pages.



Learn more about the **Environmental Data Program**

Life Is On



Schneider Electric Industries SAS

35, rue Joseph Monier
CS 30323
92506 Rueil Malmaison Cedex
France

RCS Nanterre 954 503 439
Capital social 928 298 512 €
www.se.com

05-2025

© 2025 - Schneider Electric. All Rights Reserved.
All trademarks are owned by Schneider Electric Industries SAS or its affiliated companies.
Document reference:LSB03605EN

This document has been
printed on recycled paper

