

NEVE UP

**The smart choice.
It's now connected**

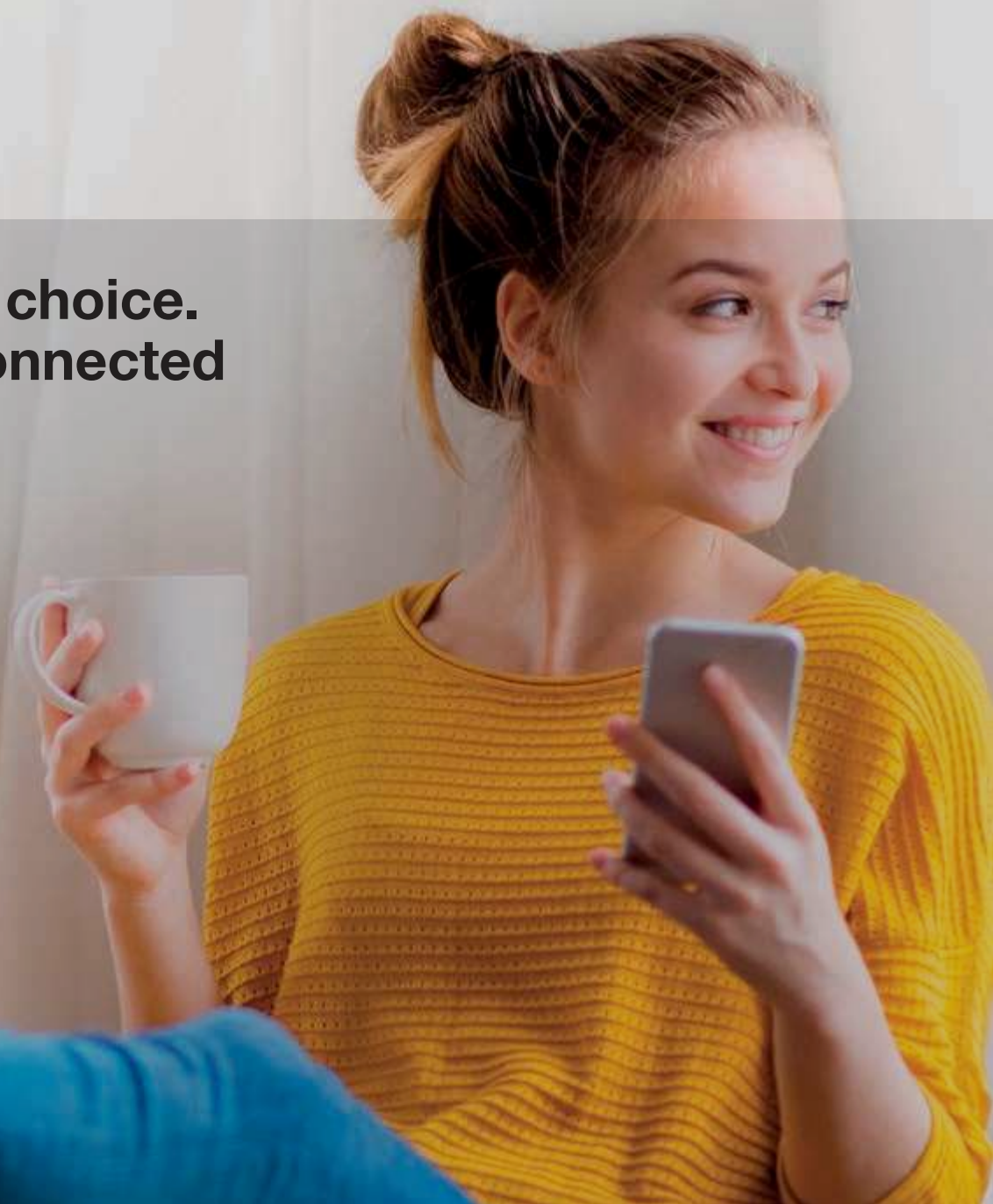

It's a
smart
choice!



NEVE UP.

A great choice for
any residential, hospitality
and office space.

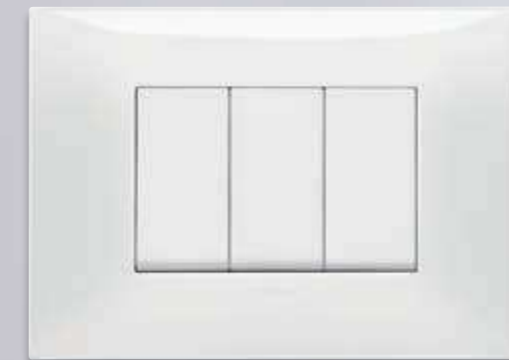

- > **Smart and connected.** Ideal for renovations, upgrades and new buildings 
- > Simple silhouettes, modern shape
- > Versatile and modular range
- > Easy and convenient solutions
- > Wide range of applications with new **IP55** and **IP40 mounting boxes** 
- > New opportunities. It's up to you!

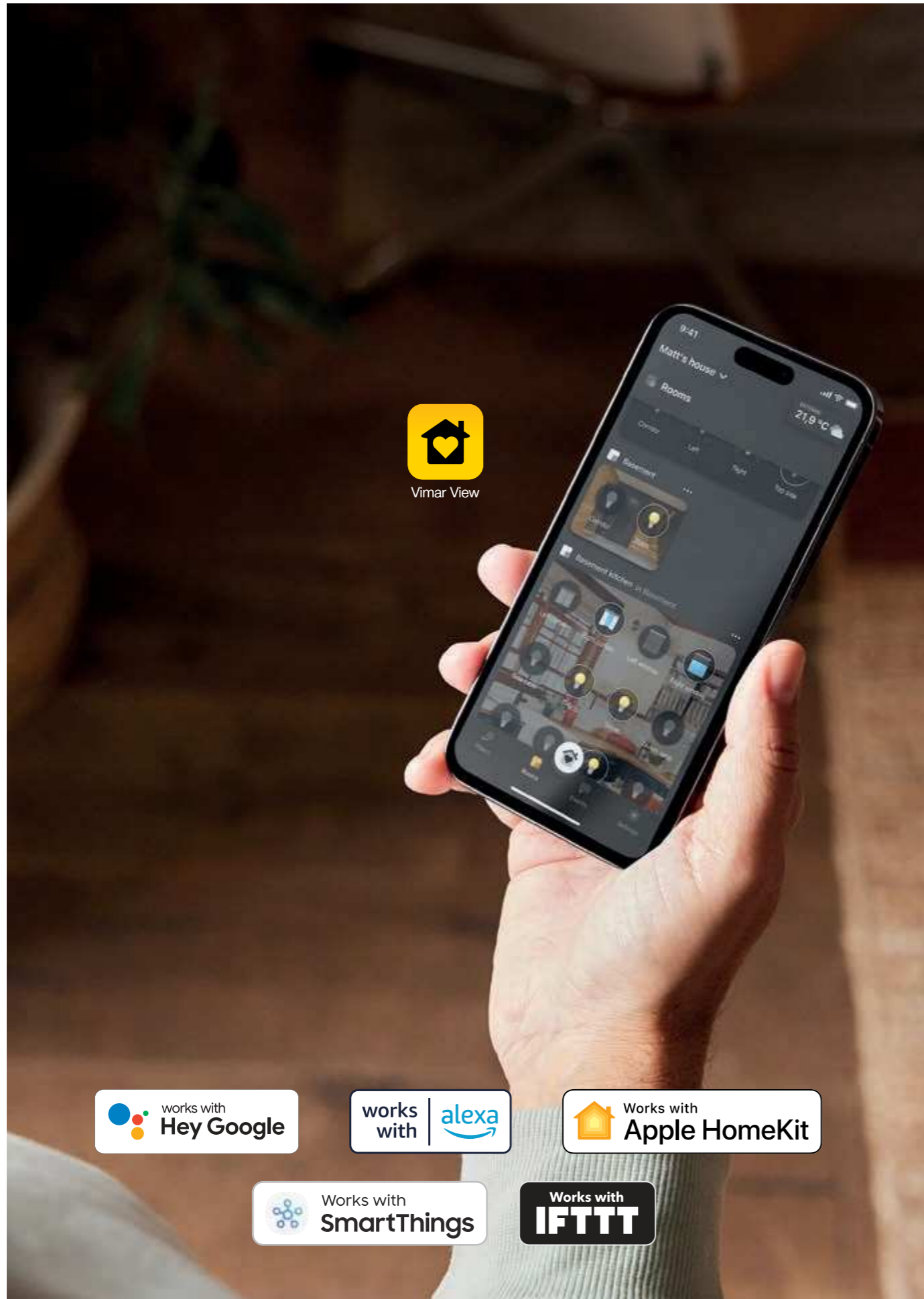

NEVE UP. Smart and connected. The View Wireless System.

The View Wireless system, thanks also to the **connected dimmers**, allows you to **manage room lighting, roller shutters or curtains and access control**, and does so more easily and safely with the **new presence detectors**. It also allows you to control **the temperature, monitor energy consumption, manage loads and set scenarios** with maximum simplicity **via the classic 1-way switches, the View app or directly with your voice**. View Wireless is **ideal in the event of renovations or to enhance the functions of an existing system**. It is also a **useful support means for the elderly and for people with restricted mobility**, thanks also to the **Assisted Living** function enabled by the radar sensors.

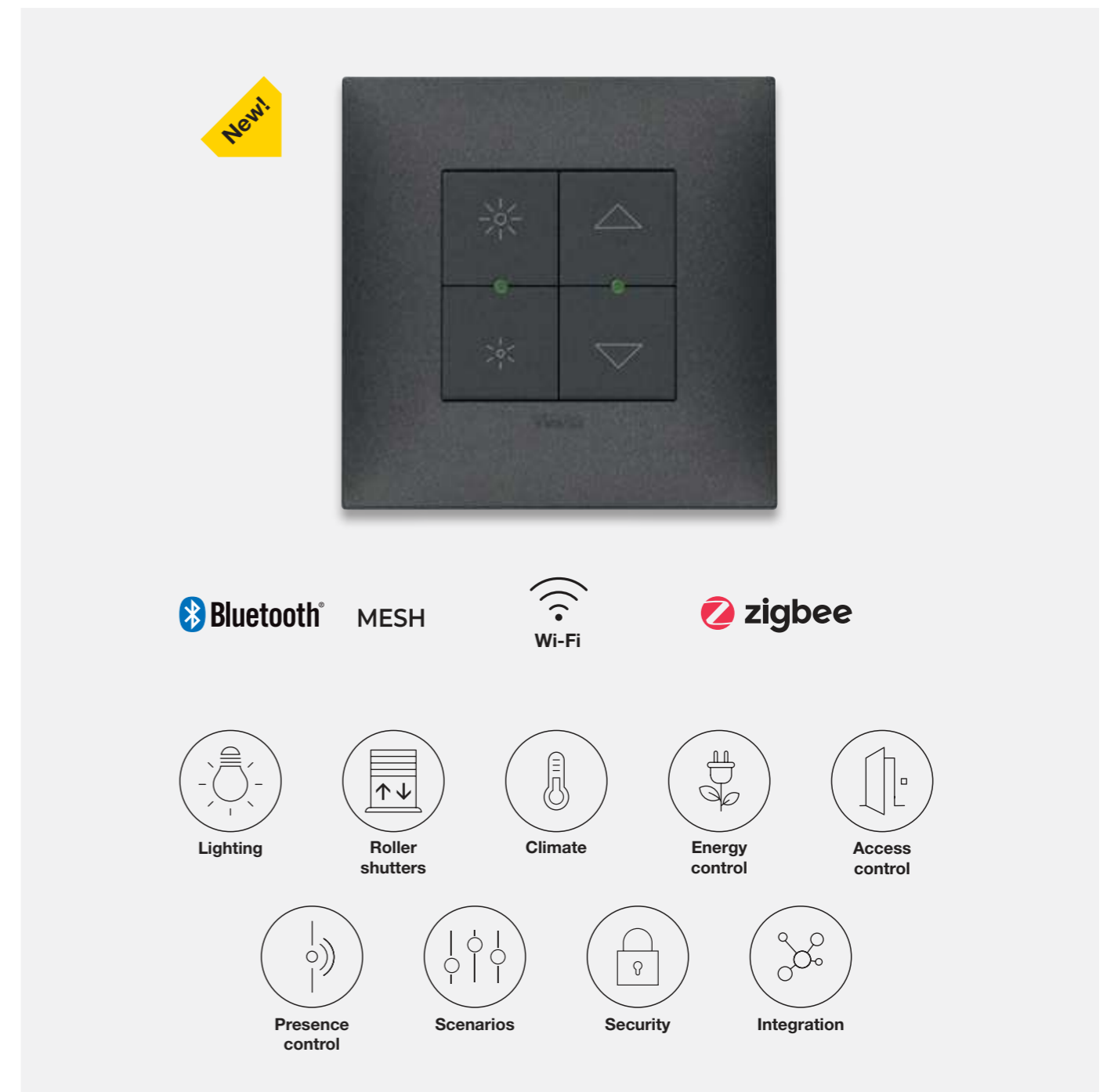

NEVE UP. It's now connected.

Easier and more functional.

Compared to a traditional system, the connected system makes it possible to have more functions **at hand**, or **vocally controllable**. A connected home thus guarantees **greater comfort**, **more efficiency** and **security** both when you are inside the environments as well as when you are out of doors, enhancing the value of the property and **improving life for its inhabitants**

THE CONVENIENCE OF CONTROL VIA APP.

To control the status of lights, the position of curtains and motorised roller shutters, as well as temperature, accesses and energy loads, wherever you may be.



THE OPPORTUNITY OF VOICE CONTROL.

Controlling your home with your voice makes technology accessible to everyone, including the elderly or the disabled.



THE RELIABILITY OF A PHYSICAL DEVICE COMBINED WITH THE FREEDOM OF A WIRELESS ONE.

Pressing a 1-way switch expands your freedom thanks to the battery-free and wireless digital controls, which can be positioned and inserted in any environment and surface according to personal preference.

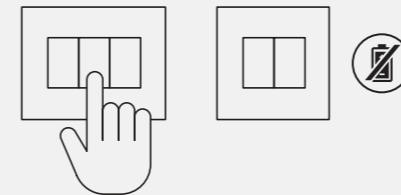

THE PERFECT SCENARIOS, WITH JUST ONE TOUCH.

The scenarios can be recalled through various devices: physical switch, via the View App and also via the Tab 5S Up and Tab 7S Up video entryphones.

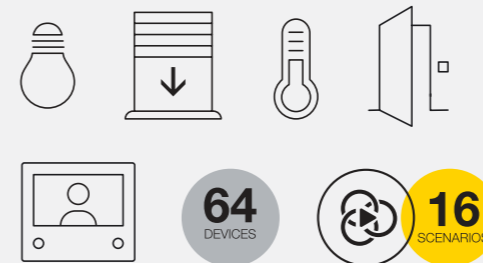

TEMPERATURE CONTROL, COMFORT AND ENERGY SAVING.

Smart thermostats to manage the heating and air conditioning for the maximum comfort of the entire home but also to avoid energy waste.

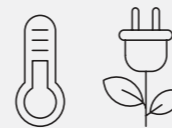

NEVE UP. It's now connected.

Smarter and easier control.

It's versatile to update, extend or replace the wiring system over time into a connected system, suitable for any architectural context. View Wireless is the ideal solution when **renovating** an area of the home or an entire dwelling, store, restaurant, office and in those situations where **masonry work** and repainting tasks **need to be kept to a minimum**.

SMART SYSTEM FOR ACCESS CONTROL.

Ideal for small and medium-sized facilities such as small hotels or B&Bs, it offers guests the best in terms of comfort and safety, guaranteeing the manager high management performance and energy efficiency. With the new View Key App, the smartphone can become a key ring to access restricted areas.

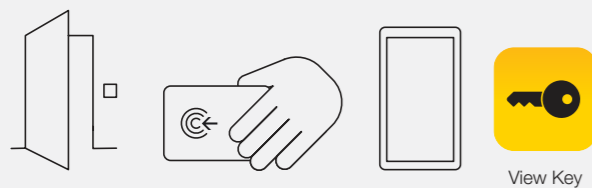

MONITORING CONSUMPTION TO PREVENT POWER OUTAGES.

Checking the electricity consumption of your entire home or of individual appliances from your smartphone, monitoring the production of the photovoltaic system. It's easy to control the single load thanks to the smart actuator for measuring the instant power and load cut-off threshold.



ALWAYS THE RIGHT SETTING LIGHTING TO AVOID ENERGY WASTAGE.

Thanks to the connected dimmers, installed at home, in the office or a hotel, you can manage your lighting in a smarter way: you obtain the appropriate degree of lighting depending on the circumstances, avoid energy wastage and make lighting management of all settings simpler and more convenient, while being aware of correct energy usage.



EASIER TO MANAGE ACCOMMODATION FACILITY FOR THE GUESTS IN HOTELS AND OFFICES.

Thanks to the mounting sensor with Ultra Wide Band radar technology, it's possible to measure micro-movements of the body with the utmost precision to detect the presence of a person in a room and match scenarios: turn on the light or activate the temperature control.



ASSISTED LIVING.

The ceiling radar sensor is able to measure an accidental fall within the detection range and send a notification alert to the smartphone of a person capable of providing assistance or activate a scenario.

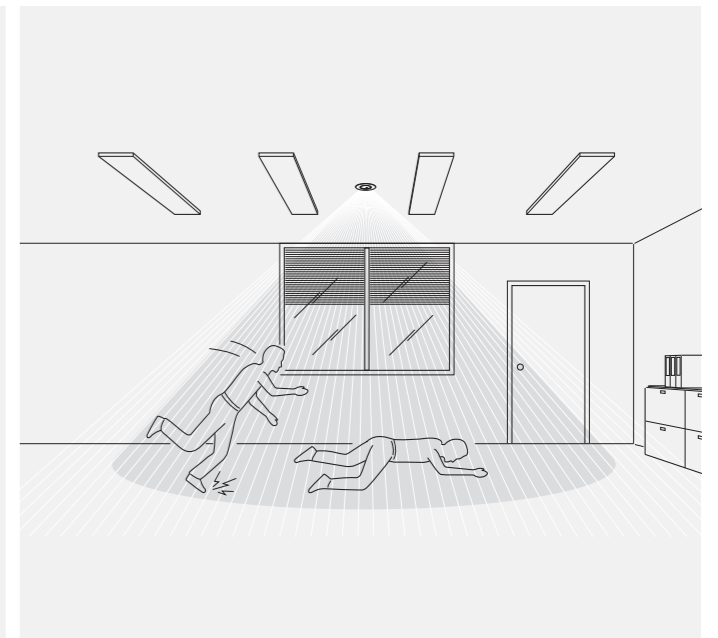

NEVE UP. Discover View Wireless.

Update your living spaces with ease.

View Wireless is the ideal solution for turning a traditional system into a connected one. **Reduce masonry and repainting.** Full control of the home is possible.

Bluetooth

SCENARIOS USING TAB 5S UP AND TAB 7S UP OR SMARTPHONE

Wi-Fi

GATEWAY

MESH

TEMPERATURE AND CONSUMPTION

ROLLING SHUTTERS

LIGHTS DIMMER

PRESENCE AND ACCESS CONTROL

SCENARIOS AND GROUPS

16 SCENARIOS

CONTROL USING VOICE CONTROL OR APP, LOCALLY AND/OR REMOTELY

Vimar View

works with Hey Google

works with alexa

Works with Apple HomeKit

Works with IFTTT

zigbee

CONTROL USING VOICE CONTROL OR APP, LOCALLY AND/OR REMOTELY

Wi-Fi

Zigbee hub

LIGHTS DIMMER

SHUTTERS

TEMPERATURE

ENERGY

works with alexa

Works with SmartThings

Your installation is easy to fit.

Simply replace the traditional devices in the existing system with the connected devices and power them: switches, actuators for roller shutters and curtains, actuators for connected socket outlets, equipped with Bluetooth® and Zigbee® technology.

JUST A FEW TASKS. NO NEED FOR MASONRY WORK. IT IS VERSATILE. NEW SYSTEM, SAME SHAPE.

TRADITIONAL DEVICE

CONNECTED DEVICE

TRADITIONAL DEVICE WITH CONNECTED ACTUATOR FOR RETROFIT INSTALLATION

TRADITIONAL DEVICE

CONNECTED ACTUATOR

To facilitate the conversion of a traditional electrical system into a connected system, in particular if composed of devices and relays, the retrofit **connected relay module** is available for the control of incandescent lamps, LED lamps and fluorescent lamps.



NEVE UP. A new recognizable design to guarantee full functionality, quality, security and easy installation.

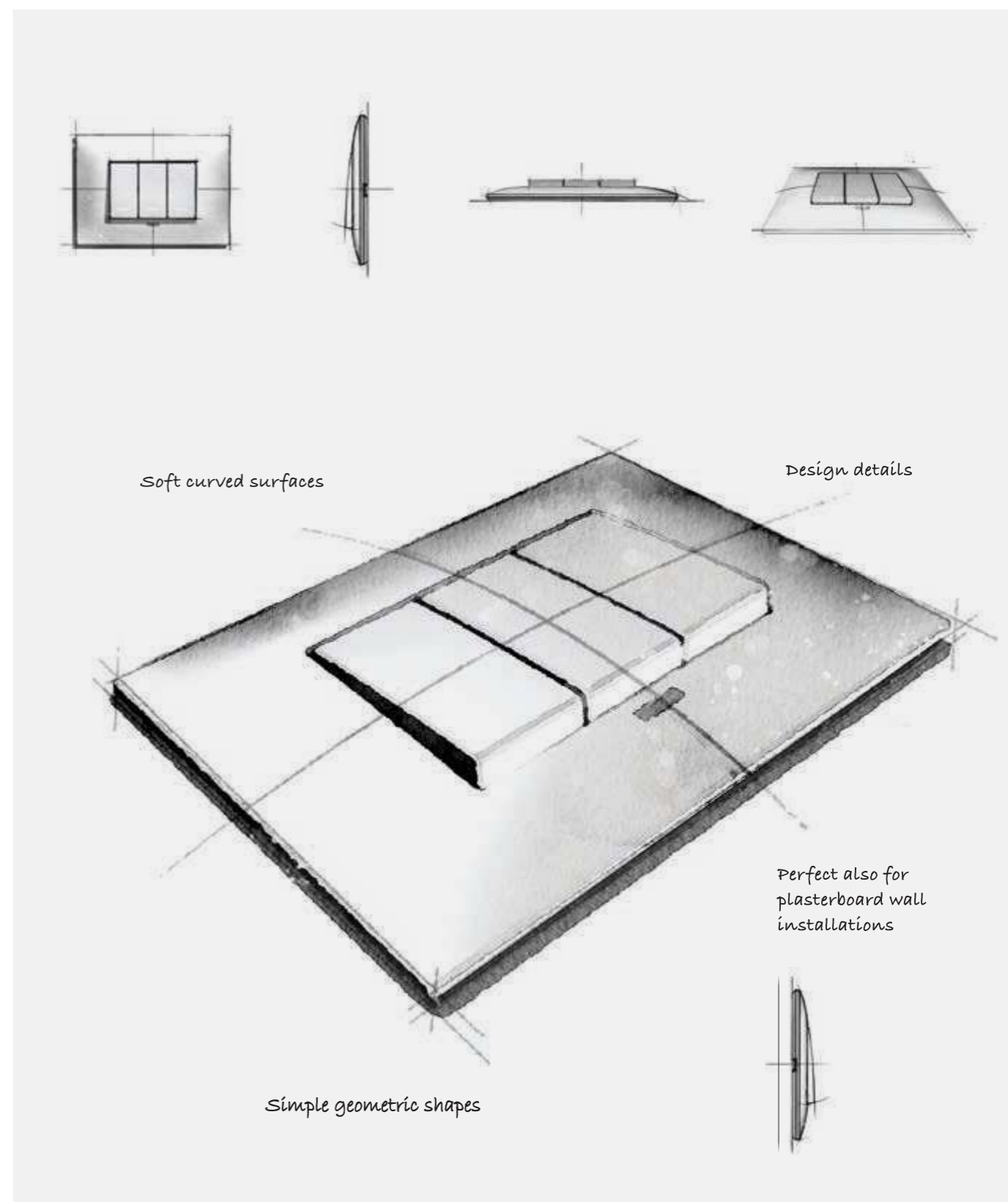

NEVE UP

NEVE UP.
Black or white?



We have designed a comprehensive system that allows you, with the flexibility of its modular system, to have more opportunities to create or upgrade your existing electrical installation.

Choose the
Total Look style.



Total Look - White
Total Look - Carbon matt

A unique style, total look in black or white, or carbon matt, all perfectly coordinated. Same colour for cover plates and switches.

NEVE UP is bright white
but not just white!

NEVE UP has **many finishes**: from **glossy** basics to **matt** and **metal**. **12 finishes** to combine with the white and carbon matt devices.



Glossy technopolymer



White - Total Look



Ivory



Slate grey



Black

Matt painted technopolymer

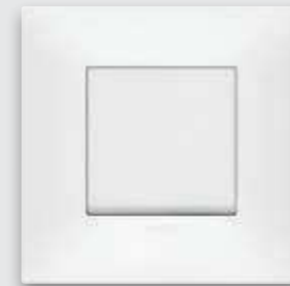

Matt white



Matt dove grey



Matt clay



Carbon matt - Total Look

Metal metallic painted technopolymer



Matt silver



Matt nickel

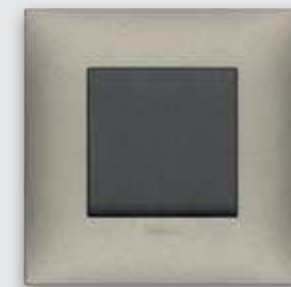

Matt titanium



Matt copper

Glossy technopolymer

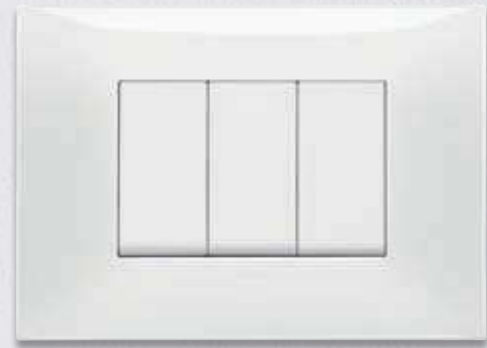

White - Total Look



Slate grey

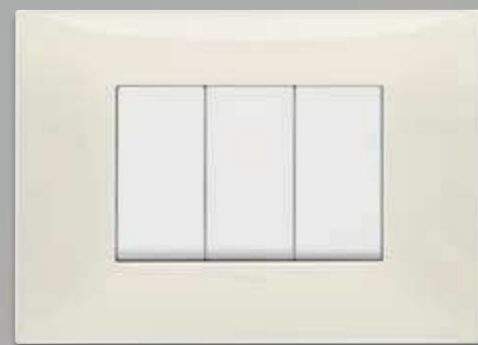

Ivory



Black

Matt painted technopolymer

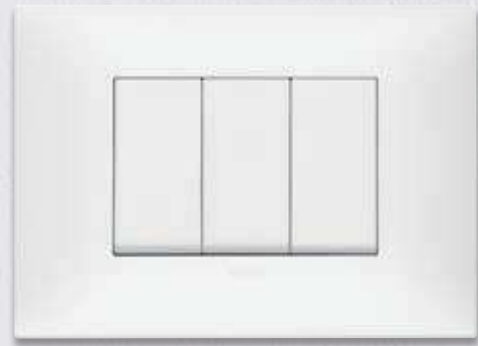

Matt white



Matt clay

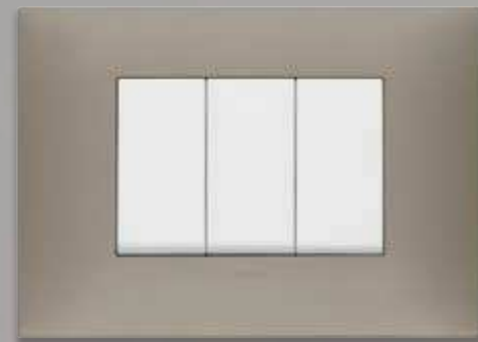

Matt dove grey

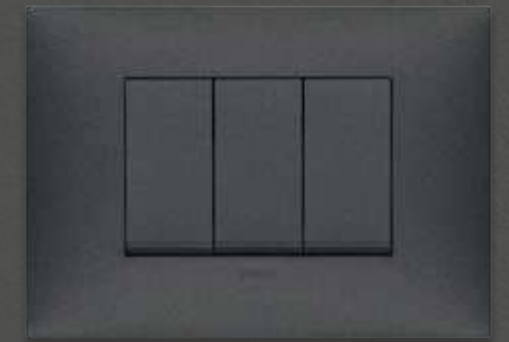

Carbon matt - Total Look

Metal metallic painted technopolymer

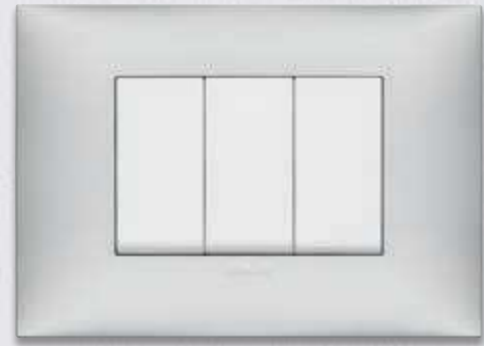

Matt silver



Matt titanium

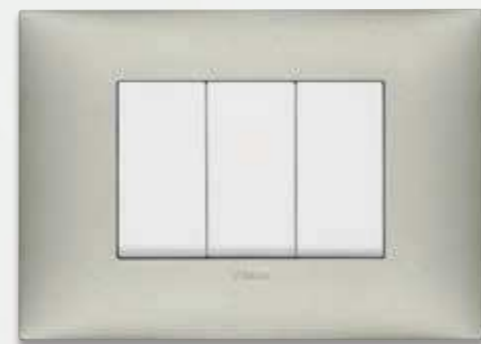

Matt nickel



Matt copper



NEVE UP. New, extensive, versatile and multistandard range.

We have redesigned NEVE UP to accommodate the various requirements in different countries: an extensive and versatile range of devices in **all international standards**, available for both Italian/US and French/German standards.

MODULAR & MULTI-MODULAR SOLUTIONS (Italian/US standard)

Thanks to the modularity of the devices: for cover plates with 1, 2, 3 and up to 7 modules.

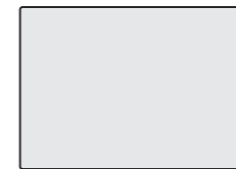

3 blank modules

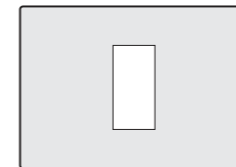

1 central module

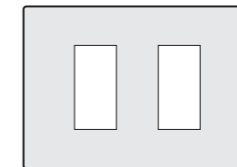

2 separate modules

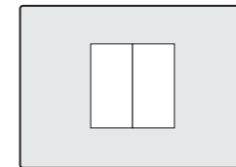

2 central modules

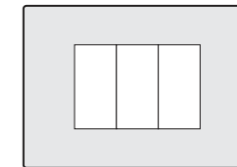

3 modules

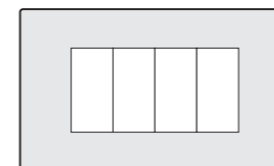

4 modules

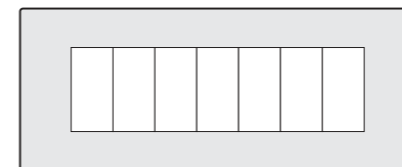

7 modules

MULTIGANG SOLUTIONS (French/German standard)

Multigang cover plates are available for the French-German standard up to four gangs, to cover any modularity requirement.

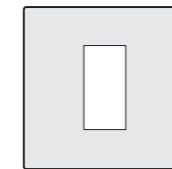

1 central module

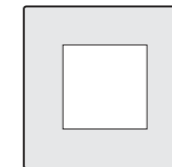

2 modules

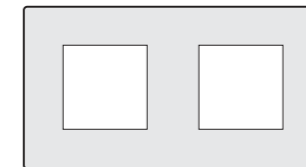

2+2 modules

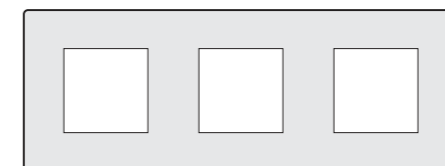

2+2+2 modules

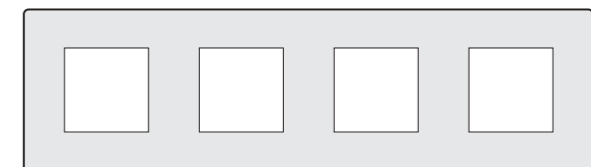

2+2+2+2 modules

NEVE UP. Easy and convenient stand-alone solutions **for the home and office.**

STAND ALONE THERMOSTAT.

Dial operated thermostat, a sleek design in a super-easy-to-use thermostat. A dial to adjust the temperature, 4 preset buttons for ON/OFF selection, °C/°F setting, summer/winter mode selection and display brightness adjustment.



USB SOCKET OUTLETS.

The type A USB charger has now been supplemented with the type A+C and C+C one, the new technological standard used to power and charge latest-generation devices. Ideal in hotel rooms and offices.



ALWAYS THE RIGHT LIGHTING TO AVOID ENERGY WASTAGE.

Thanks to the connected dimmers, installed at home, in office or hotel, you manage your lighting in a smarter way: you obtain the appropriate degree of lighting depending on the circumstances, avoid energy wastage and make lighting management of all settings simpler and more convenient, being aware of correct energy usage.



EMERGENCY LAMP.

The emergency lamp comes on in the event of a power outage to guide you safely in the dark.



INFRARED 1-WAY SWITCH.

Without touching the switch, the infrared motion sensor turns the lights on and off only at night when someone passes by. Ideal for optimising electricity consumption levels and to avoid contact with the lighting device.



NEVE UP. Easy and convenient stand-alone solutions for hospitality.

THE BEST TEMPERATURE EVERYWHERE.

The optimum climate control by means the programmation of the 7 days per week temperature, it is very easy and the clear display helps you to change the setting at any time and even from smartphone and tablet.



SMART SYSTEM FOR ACCESS CONTROL.

Ideal for small and medium-sized facilities such as small hotels or B&Bs, it offers guests the best in terms of comfort and safety, guaranteeing the manager high management performance and energy efficiency. With the new View Key App the smartphone can become a key ring to access restricted areas.

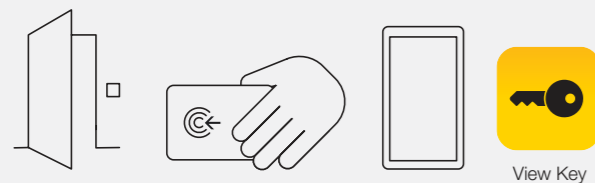

SHAVER SOCKET OUTLET AND CORD-OPERATED PUSH BUTTON.

For use in B&Bs and small hotels, the shaver socket outlet has a 20 VA isolating transformer with a power supply of 230 V and 120 V. There is also a cord-operated push button for installation in the bathroom for the safety of guests.



SPECIAL PUSH BUTTONS.

The Do Not Disturb and Please Clean push buttons facilitate communication between guests and service staff of the hotel, for enhanced guest comfort and quiet.



A FULL RANGE OF DATA AND POWER SOCKET OUTLETS.

Wide range of power socket outlets, from German to French standard, from Italian to American ones. Data, USB and TV-Radio-SAT socket outlets all guarantee fast and safe connection to a high quality standard.



NEVE UP. New watertight boxes. Protected from dust and humidity.

IP55

IP40

The new enclosures extend their field of action to environments where IP40 and IP55 degrees of protection are required: warehouses, basements and boiler rooms, construction sites, terraces, gardens and sports facilities. Wall mounted for 3 and 4 modules with transparent anti-UV membrane. For wall installation with IP55 protection against dust and water splashes. **Suitable for use in different contexts** thanks to the **glossy white and black finishes** with a central part made of a soft membrane for activating the 1-way switches without opening the door of the enclosure.



NEVE UP. Protection first and foremost.

Co-ordinated, versatile and hard-wearing range.



















- **Easy installation** of devices thanks to the **160° opening of the door**.
- Easy use thanks to the **system that blocks the door open at 120°**.
- **Easy access** to the devices thanks to the **large opening and accessible door release**.



Opening of door up to **160°**

Possibility of **blocking** the door at **120°**



Range	Models / Colours	Modularity	Specifications
IP55	  	 2M  3M  4M	<ul style="list-style-type: none"> • 160° door opening • 120° door lock • Installation/removal of devices from the front (insertion of screwdriver from rear)
IP55	  	 2M  3M  4M	<ul style="list-style-type: none"> • 160° door opening • 120° door lock • Installation/removal of devices from the front (insertion of screwdriver from rear) • Pre-drill walls • 1 hole already present + cable gland
IP40	  	 2M  3M  4M	<ul style="list-style-type: none"> • Installation/removal of devices from the front (insertion of screwdriver from rear) • Pre-drill walls • 1 hole already present + cable gland

NEVE UP.

Opportunities for you

We are a team of professionals who provide expert support and customized global solutions for automating, connecting and monitoring the entire building while assuring totally matching styling of all visible devices.



vimar.com - our on-line service platform, available 24/7. Vimar's know-how at your fingertips.

Navigate the on-line catalogue, a detailed database of all our codes with technical drawings, instruction sheets, and product photos.

Go to the **download section** and choose your language:

- **Dedicated catalogues** and **brochures** of our product range, systems and solutions.
- **Video** tutorial section, also available on You Tube channel.

From the homepage go to the **News** to stay up-to-date and to **References** to see our latest **Projects**.



We design with a sustainable approach.

Our commitment to the future

Products assessed according to the LCA approach

The painting process only uses water-based or UV-reticulating paints for an extremely low solvent emission into the atmosphere. We assess the environmental performance of Vimar's high-turnover products according to the LCA (Life Cycle Assessment) approach, with respect to the international reference standards ISO 14040 and 14044.

Headquarters with renewable energy.

For the supervision and analysis of energy consumption levels in our plants, we have adopted the logic of smart metering. Our new logistics and production pole has been fitted with an open-circuit geothermal system, 3000 square metres of biodynamic cement panels, while the roof of the building has been planted with Sedum green affording greater thermal insulation and covered with 2,442 photovoltaic modules. These design choices show sustainability, architectural value and occupational comfort expressed to the full.

Eco-packaging

The cardboard cases and containers for the products and the cardboard boxes for transport are made from recycled material, printed with water-based ink and use exclusively ecological glues. We use paper with the FSC mark which certifies the origin of responsibly managed forests, as well as allowing its traceability. We have reduced the weight of the packaging and discarded the mixed ones to facilitate sorting.



Catalogue section

Control devices	44
Power and signal socket outlets	48
Signalling	52
Climate control	52
Hotel solutions	53
View Wireless Smart home	54
Surface mounting enclosures and covers	60
Range of cover plates	62
Installation types	66

NEVE UP Free to change.

Flexible modular system installations.

Thanks to the many mounting frames available, ranging from 1 up to a maximum of 7 or 2+2+2+2 modules, devices with 1, 2, 3 modules, an extensive range of solutions can be found for all installation needs. The lighting switch can be completed with the cover plate in the colour and material of your choice.



2 modules

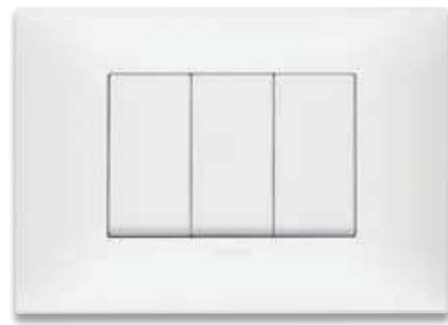

3 modules

Customization and backlighting.
Backlit and customized devices are available both in white and carbon matt colours, to easily locate the switch and immediately know its function.



Modular devices.
Combinations with 1, 2 and 3 module devices on 3 module mounting frames.

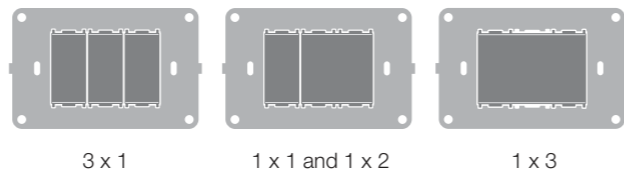

3 x 1

1 x 1 and 1 x 2

1 x 3

COVER PLATES + INTERCHANGEABLE DEVICES + MOUNTING FRAME



Add and change functions over time, depending on your specific living needs.



2+2 modules



2+2+2 modules, vertical use

2+2+2 modules, horizontal use

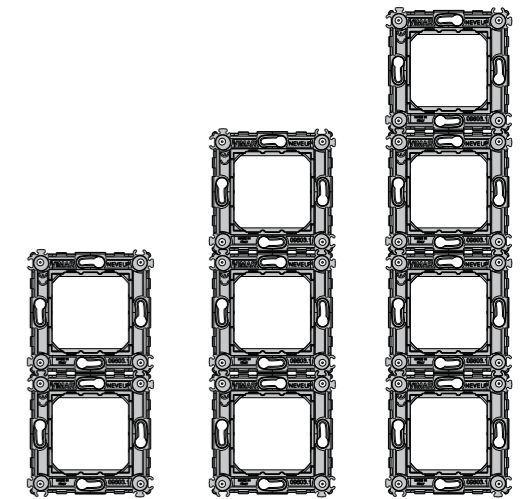

90°
Multigang switches can be used horizontally or vertically depending on the specific needs of the setting.

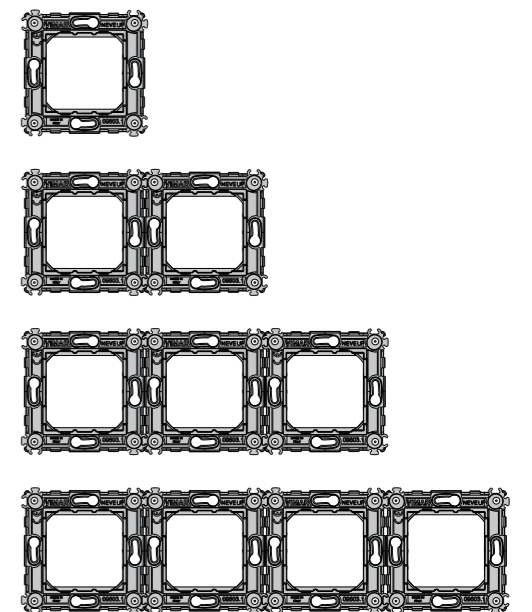

NEVE UP is quality for quick and easy installation. We take care of every detail

Your installation is easy to fit.

Installation is made easier thanks to the mounting frame with interlocking teeth that provide strong and reliable fixing for each single device and allows perfect alignment between devices to create a tidy and delightful stylistic effect. The devices are fixed front-on to the mounting frame, allowing work on the installation at any time without having to remove the mounting frame from the box.



Improved electrical load transmission.

The use of noble metals such as silver for the terminal contacts makes the conduction of the electrical load easier, thereby lowering the operating temperature of the contacts making the device last longer.

Screw terminals.

The metal plate in the terminals is curved: a Vimar refinement allowing different cross section wires to be held in place when clamped even at the same time. Secure fastening is assured for both signal circuit cables with cross-section 0.5-2.5 mm² and power circuit cables with cross-section 1.5-2.5 mm².

It's easy and flexible to upgrade over time

- Front clamping system for an easy mechanism installation when the support frame is already installed on the wall
- Specially designed terminal blocks prevent the mechanism from being subjected to strain when the screw is overloosened, allowing a power drill to be used for tightening and loosening the screws without damaging the mechanism



Perfect alignment of buttons on the mounting frame.

The stiffness of the mounting frame along with the small production tolerances provide the required dimensional accuracy to guarantee perfect aligned rocker switches. The special structure also makes it possible to compensate for the thickness of the mounting box for plasterboard, guaranteeing the perfect fit of the cover plate with the wall.

Perfect styling result, even on plasterboard walls

NEVE UP is the ideal on plasterboard.

The special structure of the mounting frame affords an attractive flush-fit effect, where the cover plate blends in seamlessly with the wall. In installations on plasterboard walls, it also covers the protrusion of the mounting box perfectly.



Mounting features

Italian and American standard

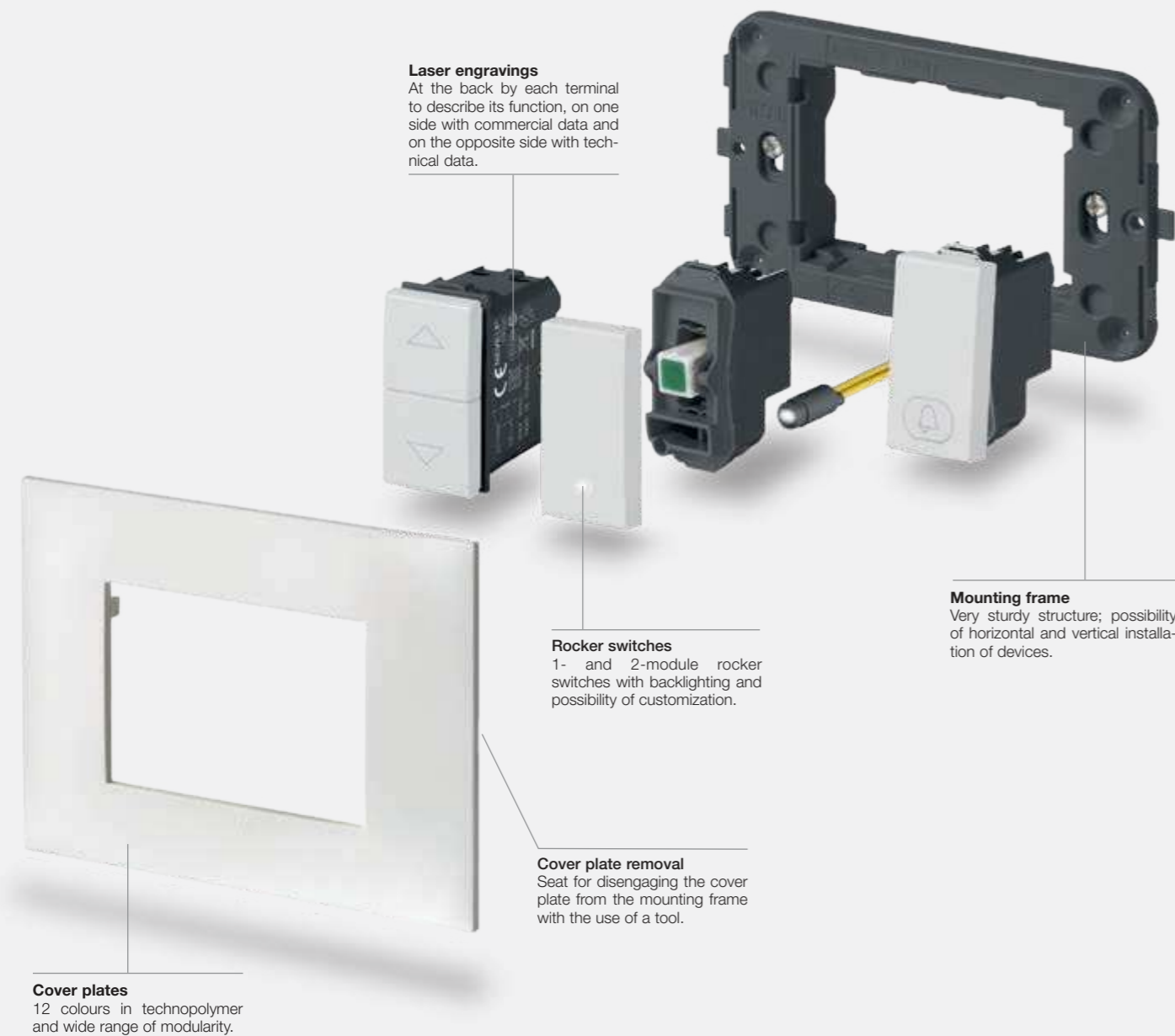

Composition	Boxes	Frames	Devices	Cover plates
 1-central module, round box 2 modules, round box	 Flush mounting	 With/without screws or with claws	 1 module 1 x 2 modules 2 x 1 module	 1-central module* 2 modules*
 2-central modules, for round or 3-module box	 Flush mounting Flush mounting	 With screws With screws	 2 modules 2 x 1 module	 2-central modules*, vertical 2-central modules*, horizontal
 From 1-central to 2-separate modules, for 3-module box From 3 to 7 modules	 Flush mounting	 With screws With screws With screws	 1 module 2 x 1 module 1 and 2 modules 3 x 1 module 3 modules	 1-central module* 2-separate modules* From 3 to 7 modules* Blank module*
Installation of Plana devices				
 3 modules with Plana devices	 Flush mounting	 Mounting frame for Plana devices, with screws	 3 x 1 module, Plana devices	 Neve Up cover plate, 3 modules*

Mounting features

German and French standard

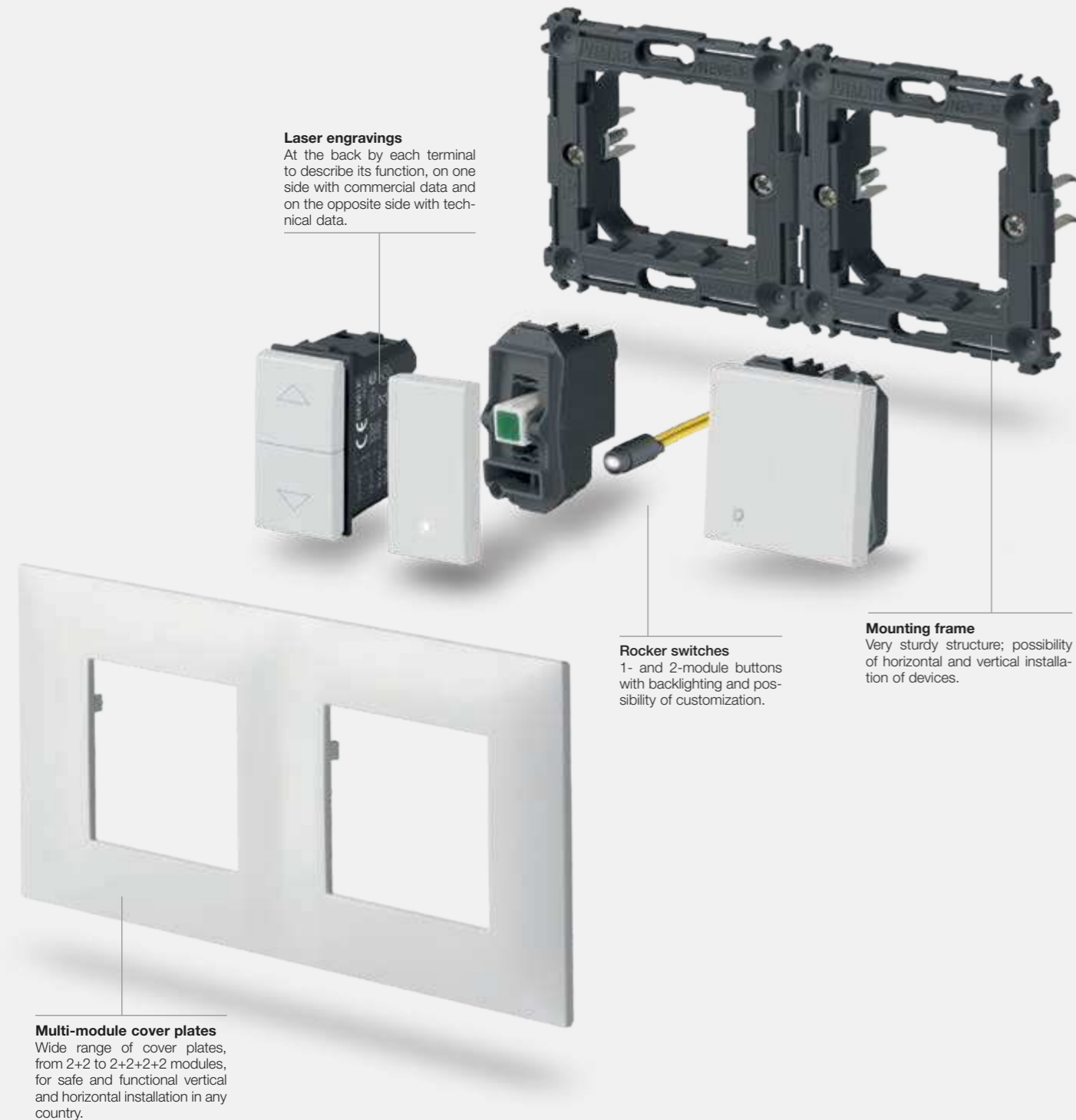

Laser engravings
At the back by each terminal to describe its function, on one side with commercial data and on the opposite side with technical data.

Rocker switches
1- and 2-module buttons with backlighting and possibility of customization.

Mounting frame
Very sturdy structure; possibility of horizontal and vertical installation of devices.

Multi-module cover plates
Wide range of cover plates, from 2+2 to 2+2+2+2 modules, for safe and functional vertical and horizontal installation in any country.

Composition	Box	Frame	Device	Cover plate
<p>2 modules, \varnothing 60 and 65 mm mounting box</p>			<p>1-gang switch, 2 modules</p>	<p>2 modules*</p>
<p>2+2 modules, 71 mm distance between centres</p>			<p>2 x 2 modules vertical</p> <p>2 x 2 modules horizontal</p>	<p>vertical</p> <p>horizontal</p>
<p>2+2+2 modules, 71 mm distance between centres</p>			<p>3 x 2 modules vertical</p> <p>3 x 2 modules horizontal</p>	<p>vertical</p> <p>horizontal</p>
<p>2+2+2+2 modules, 71 mm distance between centres</p>			<p>4 x 2 modules vertical</p> <p>4 x 2 modules horizontal</p>	<p>vertical</p> <p>horizontal</p>

* For other combinations, see the installation types from page 68

White	Carbon Matt
-------	-------------

Blank modules and cable outlets

<p>09041 Blank module. Depth: 9 mm</p>	<p>09044 Cable outlet. Depth: 11,1 mm</p>	<p>09041.CM Blank module. Depth: 9 mm</p>	<p>09044.CM Cable outlet. Depth: 11,1 mm</p>
---	--	--	---

1P 1-way switches 250 V~

<p>09001 16 AX. Depth: 23,1 mm</p>	<p>09001.2 16 AX, - 2 modules. Depth: 23,1 mm</p>	<p>09001.CM 16 AX. Depth: 23,1 mm</p>	<p>09001.2.CM 16 AX, - 2 modules. Depth: 23,1 mm</p>
---	--	--	---

2P 1-way switches 250 V~ (lightable°)

<p>09015 16 AX. Depth: 32,7 mm</p>	<p>09016 20 AX. Depth: 25,4 mm</p>	<p>09016.G 20 AX. Depth: 25,4 mm</p>	<p>09016.2.G 20 AX, - 2 modules. Depth: 25,4 mm</p>	<p>09015.CM 16 AX. Depth: 32,7 mm</p>	<p>09016.CM 20 AX. Depth: 25,4 mm</p>	<p>09016.G.CM 20 AX. Depth: 25,4 mm</p>	<p>09016.2.G.CM 20 AX, - 2 modules. Depth: 25,4 mm</p>
<p>09020 32 A, - 2 modules. Depth: 30,5 mm</p>				<p>09020.CM 32 A, - 2 modules. Depth: 30,5 mm</p>			

Connected actuators - backside installation

03981
Control device with NO 100-240 V 50/60 Hz relay output for 500 W incandescent lamps, 100 W LED lamps, 250 VA electronic transformers, 120 W fluorescent lamps, remote control, 1 input for wired control to recall a scenario, Bluetooth® wireless technology 5.0 for View Wireless mesh system and Zigbee 3.0



1P 2-way switches 250 V~

<p>09005 16 AX. Depth: 23,1 mm</p>	<p>09005.2 16 AX, - 2 modules. Depth: 23,1 mm</p>	<p>09005.CM 16 AX. Depth: 23,1 mm</p>	<p>09005.2.CM 16 AX, - 2 modules. Depth: 23,1 mm</p>
---	--	--	---

White	Carbon Matt
-------	-------------

1P reversing switches 250 V~

<p>09013 16 AX. Depth: 26,7 mm</p>	<p>09013.2 16 AX, - 2 modules. Depth: 26,7 mm</p>	<p>09013.CM 16 AX. Depth: 26,7 mm</p>	<p>09013.2.CM 16 AX, - 2 modules. Depth: 26,7 mm</p>
---	--	--	---

1P NO push buttons 250 V~

<p>09008 10 A. Depth: 23,1 mm</p>	<p>09008.2 10 A, - 2 modules. Depth: 23,1 mm</p>	<p>09008.CM 10 A. Depth: 23,1 mm</p>	<p>09008.2.CM 10 A, - 2 modules. Depth: 23,1 mm</p>
--	---	---	--

Quid - Magnetic relay modules for lighting - backside installation

<p>03991 ON/OFF sequence pulse relay module, 1 input for NO push button, 1 NO 10 A 220-240 V~ 50/60 Hz relay output</p>	<p>03992 ON/OFF sequence pulse relay module, 1 input for NO push button, 1 input for reset push button, 1 NO 10 A 220-240 V~ 50/60 Hz relay output, luminous signalling of load status</p>	<p>03993 ON/OFF sequence pulse relay module, 1 input for NO push button, 2 NO 10 A 220-240 V~ 50/60 Hz sequence relay outputs</p>
--	---	--

Backlit mechanisms° (to be combined with white or carbon matt rockers)

<p>09001.0.250¹ 1P 16 AX 250 V~ 1-way switch. Depth: 23,1 mm</p>	<p>09005.0.250¹ 1P 16 AX 250 V~ 2-way switch. Depth: 23,1 mm</p>	<p>09008.0.12¹ 1P NO 10 A 12 V push button. Depth: 23,1 mm</p>	<p>09008.0.250¹ 1P NO 10 A 250 V~ push button. Depth: 23,1 mm</p>
---	---	---	--

1-module interchangeable rockers

<p>09021 Not lightable</p>	<p>09021.N Neutral, lightable</p>	<p>09021.G Customizable</p>	<p>09026.DND Do Not Disturb, with diffuser, lightable</p>	<p>09021.CM Not lightable</p>	<p>09021.N.CM Neutral, lightable</p>	<p>09021.G.CM Customizable</p>	<p>09026.DND.CM Do Not Disturb, with diffuser, lightable</p>
<p>09026.PLS Please Clean, with diffuser, lightable</p>	<p>09021.C Bell symbol, lightable</p>	<p>09021.L Light symbol, lightable</p>	<p>09021.P Key symbol, lightable</p>	<p>09026.PLS.CM Please Clean, with diffuser, lightable</p>	<p>09021.C.CM Bell symbol, lightable</p>	<p>09021.L.CM Light symbol, lightable</p>	<p>09021.P.CM Key symbol, lightable</p>
<p>09021.F Fan symbol, lightable</p>	<p>09021.H Flame symbol, lightable</p>	<p>09021.S Switch ON symbol, lightable</p>		<p>09021.F.CM Fan symbol, lightable</p>	<p>09021.H.CM Flame symbol, lightable</p>	<p>09021.S.CM Switch ON symbol, lightable</p>	

White Carbon Matt

2-module interchangeable buttons

09022 Not lightable	09022.N Neutral, lightable	09022.CM Not lightable	09022.N.CM Neutral, lightable

1P special switches 250 V~

09052 NO 10 A, cord-operated. Depth: 24,7 mm	09050 NO 10 A, with lightable name-plate - 2 modules. Depth: 25,2 mm	09052.CM NO 10 A, cord-operated. Depth: 24,7 mm

1P push buttons 250 V~

09066 Two independent NO 10 A Depth: 29 mm	09066.CM Two independent NO 10 A Depth: 29 mm

Switches for roller blind control 250 V~

09060 2P 10 AX 2-way switch, OFF-central. Depth: 33,5 mm	09062 1P NO 10 A 2-interlocked push buttons. Depth: 29 mm	09060.CM 2P 10 AX 2-way switch, OFF-central. Depth: 33,5 mm	09062.CM 1P NO 10 A 2-interlocked push buttons. Depth: 29 mm

Quid - Electronic relay modules and control unit modules for roller shutters

	03996 Centralizable relay module, slat orientation, with relay outputs for cosφ 0,6 motor 2 A 220-240 V~ 50/60 Hz, position saving, for backside or junction boxes installation		03997 Control unit module, 2 inputs for NO push button, 6 outputs for Quid roller shutter relay module (03996), 220-240 V~ 50/60 Hz power supply, for backside or junction boxes installation
--	--	--	---

Dimmers**

09135.1 MASTER, universal 09135.1.120 As above, 120 V~. Depth: 41,5 mm	09153 100-500 W push-push + potentiometer, 230 V~. Depth: 40 mm	*09146 60-900 W 60-300 VA, potentiometer, 230 V~. Depth: 40 mm	09147 30-500 W 30-300 VA, potentiometer, 120 V~. Depth: 40 mm	09135.1.CM MASTER, universal 09135.1.120.CM As above, 120 V~. Depth: 41,5 mm	09153.CM 100-500 W push-push + potentiometer, 230 V~. Depth: 40 mm	*09146.CM 60-900 W 60-300 VA, potentiometer, 230 V~. Depth: 40 mm	09147.CM 30-500 W 30-300 VA, potentiometer, 120 V~. Depth: 40 mm

White Carbon Matt

Dimmer - controllable loads

Type	UNIVERSAL							
	09135.1				09135.1.120			
	2-wire connection		3-wire connection		2-wire connection		3-wire connection	
LOADS	LE	TE	LE	TE	LE	TE	LE	TE
Incandescence	40 ÷ 400 W	40 ÷ 300 W	40 ÷ 400 W	40 ÷ 300 W	40 ÷ 400 W	40 ÷ 300 W	40 ÷ 400 W	40 ÷ 300 W
Compact fluorescent lamps (CFL)	10 ÷ 100 W max 5 lamps	10 ÷ 200 W max 10 lamps	10 ÷ 100 W max 5 lamps	10 ÷ 200 W max 10 lamps	10 ÷ 100 W max 5 lamps	10 ÷ 200 W max 10 lamps	10 ÷ 100 W max 5 lamps	10 ÷ 200 W max 10 lamps
LED	5 ÷ 100 W max 10 lamps	5 ÷ 200 W max 20 lamps	3 ÷ 100 W max 10 lamps	3 ÷ 200 W max 20 lamps	5 ÷ 100 W max 10 lamps	5 ÷ 200 W max 20 lamps	3 ÷ 100 W max 8 lamps	3 ÷ 200 W max 16 lamps
Electronic transformers for halogen lamps	40 ÷ 300 VA max 3 transformers type	40 ÷ 300 VA max 5 transformers type	40 ÷ 300 VA max 3 transformers type	40 ÷ 300 VA max 5 transformers type	40 ÷ 300 VA max 3 transformers type	40 ÷ 300 VA max 5 transformers type	40 ÷ 300 VA max 3 transformers type	40 ÷ 300 VA max 5 transformers type

Dimmer - controllable loads

Type	STANDARD		
	09153 (with push-push switch and rotary potentiometer control)	09146 (with rotary potentiometer)	09147 (with rotary potentiometer)
LOADS			
Incandescence	100 - 500 W	60 - 900 W	30 - 500 W
Ferromagnetic transformers for halogen lamps		60 - 300 VA 230 V~, 50/60 Hz	30 - 300 VA 120 V~, 50/60 Hz

Infrared switches

09181 Lighting switch, NO 6 A 230 V~ relay output, 50/60 Hz. Depth: 37 mm	09181.CM Lighting switch, NO 6 A 230 V~ relay output, 50/60 Hz. Depth: 37 mm

Smart radio frequency devices

03955 Flat control with four push buttons with 868 MHz radio frequency transmitter, EnOcean standard, energy harvesting power supply provided by the built-in electro-dynamic generator, 2 modules.	03925 Flat control with four push buttons with 2.4 GHz radio frequency transmitter, Bluetooth Low Energy standard, energy harvesting power supply provided by the built-in electro-dynamic generator, 2 modules.	03905 Flat control with four push buttons with 2.4 GHz radio frequency transmitter, ZigBee Green Power standard without batteries, power supply provided by the built-in electro-dynamic generator, 2 modules.	03906 Flat control with four push buttons with 2.4 GHz radio frequency transmitter, ZigBee Green Power and Friends of Hue standard, energy harvesting power supply provided by the built-in electro- dynamic generator, 2 modules.

09507 Mounting frame for surface mounting of EnOcean, Bluetooth, ZigBee radio controls to be completed with Neve UP 2-module cover plates	09507.CM Mounting frame for surface mounting of EnOcean, Bluetooth, ZigBee radio controls to be completed with Neve UP 2-module cover plates
09506 1-module interchangeable button for EnOcean, Bluetooth, ZigBee radio control - 2 pieces	09506.CM 1-module interchangeable button for EnOcean, Bluetooth, ZigBee radio control - 2 pieces
09506.2 2-module interchangeable button for EnOcean, Bluetooth, ZigBee radio control	09506.2.CM 2-module interchangeable button for EnOcean, Bluetooth, ZigBee radio control

Socket outlets

White Carbon Matt

SICURY 2P+E Italian standard socket outlets 250 V~



SICURY 2P+E socket outlets 250 V~ - German standard



SICURY 2P+E socket outlets 250 V~ - French standard



Socket outlets 250 V~ - Euro-American standard

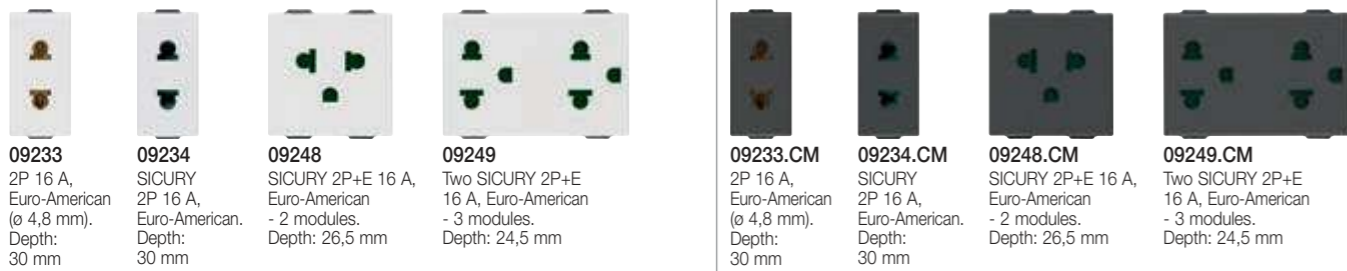

Socket outlets 127 V~ - USA and Arabian standard



Socket outlets

White Carbon Matt

SICURY 2P+E socket outlets 250 V~ - Israeli standard



SICURY 2P+E socket outlets 250 V~ - Multistandard



Socket outlets 2P+E 15 A 125 V~ 60 Hz - American standard



Possible matches between plugs and sockets according to different national standards

PLUG \ SOCKET OUTLET	German		Italian			French	Euroamerican				American Saudi Arabian				Israeli	Multistandard
	09208..	09201..	09203..	09209..	09210..	09212..	09233	09234	09248	09249	09242	09245	09243	09246	09240	09257
S10 Italian standard	•	•	•	•	•	•	•	•	•	•					•	•
S11 Italian standard		•	•	•	•											
S17 Italian standard			•		•											
2P 2,5 A Europlug	•	•	•	•	•	•	•	•	•						•	•
2P+E 16 A 250 V~ German standard	•			•	•		○	○	○	○					○	○
2P+E 16 A 250 V~ German and French standards	•			•	•	•	○	○	○	○					○	
2P 16 A 250 V~ German and French standards	•			•	•	•	•	•	•						•	
2P+E 16 A 250 V~ French standard				○	○	•	○	○	○						○	
2P+E 10 A 250 V~ Swiss standard																•
2P+E 16 A 250 V~ Israeli standard															•	
2P+E 5 A 250 V~ English standard																•
2P+E 13 A 250 V~ English standard																•
2P+E 15 A 125 V~ American standard																•
2P 15 A 127 V~ American and Saudi Arabian standards																•
2P+E 10 A 250 V~ Brazilian standard																•
2P+E 10 A 250 V~ Chinese standard																•
2P+E 10 A 250 V~ Australian standard																•

• Plug standard matches socket outlet; ○ Plug standard matches the socket outlet without earth connection.

Socket outlets • Signal reception socket outlets

White

Carbon Matt

Shaver supply units



09290
230 V~ 50/60 Hz, with 20 VA isolating transformer, 230 V~ and 120 V~ outputs - 3 modules. Depth: 42 mm



09290.CM
230 V~ 50/60 Hz, with 20 VA isolating transformer, 230 V~ and 120 V~ outputs - 3 modules. Depth: 42 mm

SICURY 2P+E socket outlets 250 V~ (for dedicated supply lines)



09203.R
Bpresa 16 A P17/11, red. Depth: 23,2 mm



09210.R
16 A, universal, red - 2 modules. Depth: 26,4 mm



09208.A
16 A, German, orange - 2 modules. Depth: 29,5 mm



09208.R
16 A, German, red - 2 modules. Depth: 29,5 mm



09208.V
16 A, German, green - 2 modules. Depth: 29,5 mm



09240.R
16 A, Israeli, red - 2 modules. Depth: 29,7 mm

USB supply unit



09292
7,5 W 1,5 A, 1 USB-A, 120-240 V~ 50/60 Hz. Depth: 37 mm



09292.C
7,5 W 1,5 A, 1 USB-C, 120-240 V~ 50/60 Hz. Depth: 37 mm



09292.AC
12 W 2,4 A, USB A+C, 120-240 V~ 50/60 Hz. Depth: 37 mm



09292.CC
15 W 3 A, USB C+C, 120-240 V~ 50/60 Hz. Depth: 37 mm



09292.CM
7,5 W 1,5 A, 1 USB-A, 120-240 V~ 50/60 Hz. Depth: 37 mm



09292.C.CM
7,5 W 1,5 A, 1 USB-C, 120-240 V~ 50/60 Hz. Depth: 37 mm



09292.AC.CM
12 W 2,4 A, USB A+C, 120-240 V~ 50/60 Hz. Depth: 37 mm



09292.CC.CM
15 W 3 A, USB C+C, 120-240 V~ 50/60 Hz. Depth: 37 mm

Special socket outlets



09330
2P 6 A 24 V (SELV), for 01620 plug. Depth: 25 mm



09330.CM
2P 6 A 24 V (SELV), for 01620 plug. Depth: 25 mm

Phone socket outlets



09320
RJ11, 6-position 4-contact (6/4). Depth: 33,6 mm



09324
Israeli standard, screw terminals. Depth: 33,4 mm



09320.CM
RJ11, 6-position 4-contact (6/4). Depth: 33,6 mm



09324.CM
Israeli standard, screw terminals. Depth: 33,4 mm

Signal reception socket

White

Carbon Matt

Coaxial TV-RD-SAT 5-2400 MHz socket outlets (output Ø 9,5 mm male and F-type female)



09300.01
Male, single connection 1 dB. Depth: 26,1 mm



09300.10
Male, through-line 10 dB. Depth: 26,1 mm



09302.01
Demix, male and F-type, single connection 1 dB - 2 modules. Depth: 22,1 mm



09300.01.CM
Male, single connection 1 dB. Depth: 26,1 mm



09300.10.CM
Male, through-line 10 dB. Depth: 26,1 mm



09302.01.CM
Demix, male and F-type, single connection 1 dB - 2 modules. Depth: 22,1 mm

Coaxial TV-FM-SAT 5-2400 MHz socket outlets (3 outputs: Ø 9,5 mm male and female + F-type)



09303
Single connection 1 dB - 2 modules. Depth: 22 mm



09303.CM
Single connection 1 dB - 2 modules. Depth: 22 mm

Coaxial TV 40-862 MHz socket outlets (1 output: Ø 9,5 mm female) and F-type socket outlets



***09313**
Single connection. Depth: 29 mm



09318
With F-type female connector. Depth: 9 mm



***09313.CM**
Single connection. Depth: 29 mm



09318.CM
With F-type female connector. Depth: 9 mm

Terminal resistors and coaxial TV-RD-SAT 2400 MHz connectors



16330
Z 75 Ω, for frequencies up to 2400 MHz



01644
Male, axial cable entry



01645
Female, axial cable entry



01634
Male, 90°-cable entry



01635
Female, 90°-cable entry



01654
Male, F-type, for RG59 cable

RJ45 data ports



09338.9
Netsafe, Cat. 5e, UTP. Depth: 26 mm



09339.6
Netsafe, Cat. 6, UTP 110. Depth: 34,2 mm



09339.14
Netsafe, Cat. 6, FTP. Depth: 39,7 mm



09339.16
Netsafe, Cat. 6a, FTP. Depth: 39,7 mm



Δ 09338.C
Adaptor, RJ45 Cat. 5/6 AMP, Keystone, Lucent T. Depth: 9 mm



09338.9.CM
Netsafe, Cat. 5e, UTP. Depth: 26 mm



09339.6.CM
Netsafe, Cat. 6, UTP 110. Depth: 34,2 mm



09339.14.CM
Netsafe, Cat. 6, FTP. Depth: 39,7 mm



09339.16.CM
Netsafe, Cat. 6a, FTP. Depth: 39,7 mm



Δ 09338.C.CM
Adaptor, RJ45 Cat. 5/6 AMP, Keystone, Lucent T. Depth: 9 mm

White	Carbon Matt
-------	-------------

Keystone universal adaptors



▲ 09339.C
Adaptor, Keystone.
Depth: 9 mm



▲ 09339.C.CM
Adaptor, Keystone.
Depth: 9 mm

Electromechanical bells - Buzzers



▲ 09372.SR
Ringtone/buzzer
120 V~ 50-60 Hz.
Depth: 31.8 mm



▲ 09373.SR
Ringtone/buzzer
230 V~ 50-60 Hz.
Depth: 31.8 mm



▲ 09372.SR.CM
Ringtone/buzzer
120 V~ 50-60 Hz.
Depth: 31.8 mm



▲ 09373.SR.CM
Ringtone/buzzer
230 V~ 50-60 Hz.
Depth: 31.8 mm

Double pilot lights (for signalling unit)



09388
Dual indicator light for 2 signalling units, neutral diffusers
Depth: 23 mm



09388.CM
Dual indicator light for 2 signalling units, neutral diffusers
Depth: 23 mm

TORCIA, electronic hand-lamps (with automatic emergency device)



09395
With high-efficiency LED,
230 V~ 50/60 Hz - 2 modules.
Depth: 41,3 mm



09395.CM
With high-efficiency LED,
230 V~ 50/60 Hz - 2 modules.
Depth: 41,3 mm



00910
Ni-MH 4,8 V 80 mAh battery,
spare part for TORCIA

Thermostats and timer-thermostats (heating and air-conditioning)



09470
Rotary dial thermostat for ambient temperature control, 5(2) A 240 V~ relay output, heating and air-conditioning ON/OFF, class I temperature control device (contribution 1%) in ON/OFF mode, white LED backlighting and brightness regulation, 100-240 V 50/60 Hz - 2 modules. Depth: 28,5 mm



09470.CM
Rotary dial thermostat for ambient temperature control, 5(2) A 240 V~ relay output, heating and air-conditioning ON/OFF, class I temperature control device (contribution 1%) in ON/OFF mode, white LED backlighting and brightness regulation, 100-240 V 50/60 Hz - 2 modules. Depth: 28,5 mm



02900.1
Electronic thermostat for ON/OFF ambient temperature control (heating and air-conditioning), class I temperature control device (contribution 1%), change-over relay output 5(2) A 240 V~, AA LR6 1,5 V battery-powered (not supplied), surface mounting, white



01910
Electronic timer-thermostat for ON/OFF ambient temperature control (heating and air-conditioning), daily/weekly programming, class I temperature control device (contribution 1%), change-over relay output 5(2) A 250 V~, AA LR6 1,5 V battery-powered (not supplied), surface mounting, white

White	Carbon Matt
-------	-------------

Switches for fan coil speed adjustment



09063
2P 10 AX 250 V~ switch for fan coil



09063.CM
2P 10 AX 250 V~ switch for fan coil

Hotel solutions



09026.DND
1-module interchangeable button, Do Not Disturb, with diffuser, lightable



09026.PLS
1-module interchangeable button, Please Clean, with diffuser, lightable



09388.SC
Double room status indicator for 2 signalling units: do not disturb and make up room



09026.DND.CM
1-module interchangeable button, Do Not Disturb, with diffuser, lightable



09026.PLS.CM
1-module interchangeable button, Please Clean, with diffuser, lightable



09388.SC.CM
Double room status indicator for 2 signalling units: do not disturb and make up room



09097
1P NO 10 A 230 V~ push button, for hotel "Do Not Disturb" and "Please Clean" lightable - 2 modules. Depth: 27,2 mm



***09257**
2P+E 13 A 250 V~ SICIURY socket outlet, multistandard - 2 modules. Depth: 18,7 mm



09290
Shaver supply unit with 20 VA isolating transformer, 230 V~ 50/60 Hz, 230 V~ and 120 V~ outputs - 3 modules. Depth: 42 mm



***09257.CM**
2P+E 13 A 250 V~ SICIURY socket outlet, multistandard - 2 modules. Depth: 18,7 mm



09290.CM
Shaver supply unit with 20 VA isolating transformer, 230 V~ 50/60 Hz, 230 V~ and 120 V~ outputs - 3 modules. Depth: 42 mm



09463
Electronic switch, vertical pocket, 120-230 V~ 50/60 Hz - 2 modules. Depth: 24,7 mm



09465
Electronic switch, vertical pocket, 230 V~ 50/60 Hz, 24 V~/24 Vdc (SELV) - 3 modules. Depth: 37 mm



09463.CM
Electronic switch, vertical pocket, 120-230 V~ 50/60 Hz - 2 modules. Depth: 24,7 mm



09465.CM
Electronic switch, vertical pocket, 230 V~ 50/60 Hz, 24 V~/24 Vdc (SELV) - 3 modules. Depth: 37 mm

White

Carbon Matt

Gateway

Bluetooth WiFi CERTIFIED



09597
IoT Bluetooth Wi-Fi Gateway for integration, configuration, supervision of VIEW Wireless, via Cloud and App for smartphone, tablet, 100-240 V 50/60 Hz power supply - 2 modules
Depth: 37.2 mm



09597.CM
IoT Bluetooth Wi-Fi Gateway for integration, configuration, supervision of VIEW Wireless, via Cloud and App for smartphone, tablet, 100-240 V 50/60 Hz power supply - 2 modules
Depth: 37.2 mm



0K14597.01
Wi-Fi Bluetooth wireless technology gateway for integration, configuration and supervising of View Wireless system by Cloud and app for smartphone and tablet, supply voltage 100-240 V 50/60 Hz, on DIN (60715 TH35) rail installation, occupies 2 17,5 mm modules



Gateway installed into the supplied frame for DIN rail

Connected 2-way switch for lights

Bluetooth zigbee certified product



09592
VIEW Wireless electronic 2-way switch with 100-240 V 50/60 Hz relay output for 500 W incandescent lamps, 100W LED lamps, 250 VA electronic transformers, 120 W fluorescent lamps, local or remote control, double IoT technology on Bluetooth 5.0 standard for the creation of VIEW Wireless mesh system and on Zigbee 3.0 standard, 1 input for external button for actuator control or to recall a scenario, RGB LED visible in darkness with brightness control, 100-240 V 50/60 Hz power supply
Depth: 37.9 mm



09592.2
As for 09592, 2 modules
Depth: 37.9 mm



09592.CM
VIEW Wireless electronic 2-way switch with 100-240 V 50/60 Hz relay output for 500 W incandescent lamps, 100W LED lamps, 250 VA electronic transformers, 120 W fluorescent lamps, local or remote control, double IoT technology on Bluetooth 5.0 standard for the creation of VIEW Wireless mesh system and on Zigbee 3.0 standard, 1 input for external button for actuator control or to recall a scenario, RGB LED visible in darkness with brightness control, 100-240 V 50/60 Hz power supply
Depth: 37.9 mm



09592.2.CM
As for 09592.CM, 2 modules
Depth: 37.9 mm

White

Carbon Matt

Connected controls for roller shutters

Bluetooth zigbee certified product



09594.0
VIEW Wireless electronic control device for 1 roller shutter with slat orientation and change-over relay output for cosφ 0.6 motor 2 A 100-240 V~ 50/60 Hz, local control with push button or remote control, double IoT technology on Bluetooth® technology 5.0 standard for the creation of VIEW Wireless mesh system and on Zigbee 3.0 standard, 1 input for external push button to recall a scenario, favourite position recall function, RGB LED visible in darkness with brightness control, 100-240 V 50/60 Hz power supply, to be completed with two interchangeable half-button caps, 1 Neve UP module.
Depth: 37.9 mm



09755.2
Two 1-module interchangeable arrow symbol half-button caps, 1 module



09755.2.CM
Two 1-module interchangeable arrow symbol half-button caps, 1 module

Connected actuator for roller shutters

Bluetooth zigbee certified product



03982
Actuator for 1 roller shutter with slat orientation and change-over relay output for cosφ 0,6 motor 2 A 100-240 V~ 50/60 Hz, remote control, Bluetooth® wireless technology 5.0 for View Wireless mesh system and Zigbee 3.0

Connected dimmers

Bluetooth zigbee certified product



09595.0
VIEW Wireless electronic dimmer mechanism for 20-200 W incandescent lamps, 2-200 W LED lamps, 20-200 W electronic transformers, double IoT technology on Bluetooth 5.0 standard for the creation of VIEW Wireless mesh system and on Zigbee 3.0 standard, 1 input for external push button for dimmer control or to recall a scenario, dimmer off operation, RGB LED visible in darkness with brightness control, 220-240 V 50/60 Hz power supply, to be completed with Neve UP 1-module interchangeable buttons
Depth: 37.8 mm



09595.0.120
VIEW Wireless electronic dimmer mechanism for 20-200 W incandescent lamps, 2-200 W LED lamps, 20-200 W electronic transformers, double IoT technology on Bluetooth 5.0 standard for the creation of VIEW Wireless mesh system and on Zigbee 3.0 standard, 1 input for external push button for dimmer control or to recall a scenario, RGB LED visible in darkness with brightness control, 120 V 50/60 Hz power supply, to be completed with Neve UP 1-module interchangeable buttons
Depth: 37.8 mm

White

Carbon Matt

Connected electronic control



09591.0
VIEW Wireless electronic control mechanism, local control with push button or remote control, double IoT technology on Bluetooth 5.0 standard for the creation of VIEW Wireless mesh system and on Zigbee 3.0 standard, RGB LED visible in darkness with brightness control, 100-240 V 50/60 Hz power supply, to be completed with Neve UP 1-module interchangeable buttons.
Depth: 37.9 mm



09755
Two interchangeable half-button caps, neutral, 1 module



09755.2
Two interchangeable half-button caps, arrow symbol, 1 module



09755.3
Two interchangeable half-button caps, dimmer symbols, 1 module



09755.6
Two interchangeable half-button caps, scenario symbols, 1 module



09755.CM
Two interchangeable half-button caps, neutral, 1 module



09755.2.CM
Two interchangeable half-button caps, arrow symbol, 1 module



09755.3.CM
Two interchangeable half-button caps, dimmer symbols, 1 module



09755.6.CM
Two interchangeable half-button caps, scenario symbols, 1 module

Connected socket outlet actuators



09593
VIEW Wireless electronic control device with NO 16 A 100-240 V~ 50/60 Hz relay output, local control with push button or remote control, double IoT technology on Bluetooth 5.0 standard for the creation of VIEW Wireless mesh system and on Zigbee 3.0 standard, function for measuring the instant power and energy consumed and load cut-off threshold, RGB LED visible in darkness with brightness control, 100-240 V 50/60 Hz power supply. Depth: 40 mm



09593.CM
VIEW Wireless electronic control device with NO 16 A 100-240 V~ 50/60 Hz relay output, local control with push button or remote control, double IoT technology on Bluetooth 5.0 standard for the creation of VIEW Wireless mesh system and on Zigbee 3.0 standard, function for measuring the instant power and energy consumed and load cut-off threshold, RGB LED visible in darkness with brightness control, 100-240 V 50/60 Hz power supply. Depth: 40 mm

Connected actuator



03981
Control device with NO 100-240 V 50/60 Hz relay output for 500 W incandescent lamps, 100 W LED lamps, 250 VA electronic transformers, 120 W fluorescent lamps, remote control, 1 input for wired control to recall a scenario, Bluetooth® wireless technology 5.0 for View Wireless mesh system and Zigbee 3.0

White

Carbon Matt

Connected Energy meter



02963
IoT device for consumption meter/production of instantaneous electricity and consumption logs (with hourly, daily, monthly, annual resolution), load control function (max 8 loads), 1 input for toroidal current sensor supplied, detectable power 25 W-10 kW, single-phase power supply 100-240 V 50/60 Hz, IoT technology on Bluetooth technology 5.0 standard for the creation of VIEW Wireless mesh system, installation on DIN rail (60715 TH35), occupies 1 module measuring 17.5 mm.

Connected thermostats



09473
Rotary dial thermostat for ambient temperature control, 5(2) A 240 V~ relay output, IoT technology on Bluetooth® wireless technology 5.0 for mesh View Wireless system realization, 1 input for outer temperature sensor, heating and air-conditioning ON/OFF and PID, class I temperature control device (contribution 1%) in ON/OFF mode, class IV (contribution 2%) in PID mode, white LED backlighting and brightness regulation, supply voltage 100-240 V~ 50/60 Hz - 2 modules. Depth: 28,5 mm



09473.CM
Rotary dial thermostat for ambient temperature control, 5(2) A 240 V~ relay output, IoT technology on Bluetooth® wireless technology 5.0 for mesh View Wireless system realization, 1 input for outer temperature sensor, heating and air-conditioning ON/OFF and PID, class I temperature control device (contribution 1%) in ON/OFF mode, class IV (contribution 2%) in PID mode, white LED backlighting and brightness regulation, supply voltage 100-240 V~ 50/60 Hz - 2 modules. Depth: 28,5 mm

Connected sensors



03980
Magnetic contact for doors and windows, IoT technology on Bluetooth technology 5.0 standard for the creation of View Wireless mesh system, 1 input for voltage-free contact, powered by AA LR6 1,5 V batteries (not supplied), white. For use as an accessory of the connected thermostat or, in combination with the IoT gateway, as a sensor for magnetic contact or voltage-free contact input opening/closing notifications.

White

Carbon Matt

Connected radar sensor

 Bluetooth®
**09179**

UWB radar sensor, IoT technology on Bluetooth 5.0 standard for the creation of VIEW Wireless mesh system, 1 solid state output for extra low voltage controls (SELV and non SELV), 1 input for external push button for output activation or to recall a scenario, 100-240 V 50/60 Hz power supply
Depth: 39.9 mm

**09179.CM**

UWB radar sensor, IoT technology on Bluetooth 5.0 standard for the creation of VIEW Wireless mesh system, 1 solid state output for extra low voltage controls (SELV and non SELV), 1 input for external push button for output activation or to recall a scenario, 100-240 V 50/60 Hz power supply
Depth: 39.9 mm

**02692**

UWB radar sensor, IoT technology on Bluetooth 5.0 standard for the creation of VIEW Wireless mesh system, 1 solid state output for extra low voltage controls (SELV and non SELV), 1 input for external push button for output activation or to recall a scenario, 100-240 V 50/60 Hz power supply, false ceiling installation.

**02692.S.1**

Round section adaptor for ceiling installation of the IoT connected radar sensor 02692.

Connected access control

 Bluetooth®
**09462**

NFC/RFID smart card landing reader, card configuration using View Wireless App, Bluetooth technology standard, IoT technology on Bluetooth technology 5.0 standard for the creation of View Wireless mesh system, 1 relay output NO 16 A 100-240 V~ 50/60 Hz, 1 DND input, LED with brightness control, 100-240 V~ 50/60 Hz power supply - 2 modules. Depth: 32.5 mm

**09462.CM**

NFC/RFID smart card landing reader, card configuration using View Wireless App, Bluetooth technology standard, IoT technology on Bluetooth technology 5.0 standard for the creation of View Wireless mesh system, 1 relay output NO 16 A 100-240 V~ 50/60 Hz, 1 DND input, LED with brightness control, 100-240 V~ 50/60 Hz power supply - 2 modules. Depth: 32.5 mm

**09467**

NFC/RFID smart card reader pocket for installation inside the room, IoT technology on Bluetooth technology 5.0 standard for the creation of View Wireless mesh system, 1 relay output NO 16 A 100-240 V~ 50/60 Hz, 1 configurable input, LED visible in darkness with brightness control, 100-240 V~ 50/60 Hz power supply, Next - 2 modules. Depth: 32.5 mm

**09467.C**

Card holder cover for NFC/RFID reader pocket and badge switch, 2 modules.

**09467.CM**

NFC/RFID smart card reader pocket for installation inside the room, IoT technology on Bluetooth technology 5.0 standard for the creation of View Wireless mesh system, 1 relay output NO 16 A 100-240 V~ 50/60 Hz, 1 configurable input, LED visible in darkness with brightness control, 100-240 V~ 50/60 Hz power supply, Next - 2 modules. Depth: 32.5 mm

**09467.C.CM**

Card holder cover for NFC/RFID reader pocket and badge switch, 2 modules.

White

Carbon Matt

LED signalling units



12-24 V~ - 0,1 W

00935.A: amber**00935.G:** green**00935.R:** red**00935.B:** blue**00935.W:** white

120 V~ 50/60 Hz - 0,2 W

00936.120.A: amber**00936.120.G:** green**00936.120.R:** red**00936.120.B:** blue**00936.120.W:** white

250 V~ 50/60 Hz - 0,35 W

00936.250.A: amber**00936.250.G:** green**00936.250.R:** red**00936.250.B:** blue**00936.250.W:** white

Accessories for floor mounting

**V54303**

Floor mount turret for Neve Up devices installation in V54903 box. Supplied with 3-module mounting frame

**V54903**

Flush box for floor mount turret V54303

IP40 enclosures



▲ 09802
2 modules

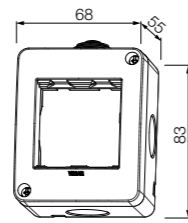

▲ 09802



▲ 09803
3 modules

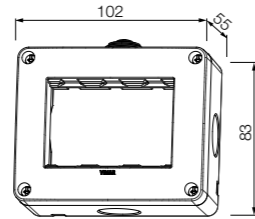

▲ 09803



▲ 09804
4 modules

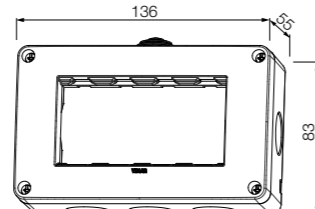

▲ 09804

IP55 enclosures



▲ 09902
2 modules

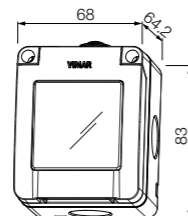

▲ 09902



▲ 09903
3 modules

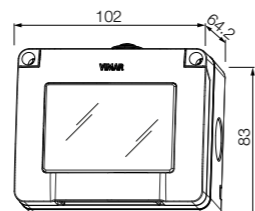

▲ 09903



▲ 09904
4 modules

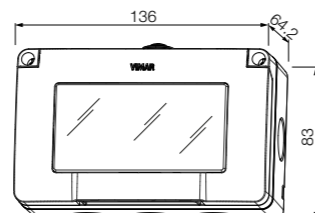

▲ 09904

IP55 covers



▲ 09911.01
with claws, for ø 60 mm boxes, white - 2 modules



▲ 09911.04
with claws, for ø 60 mm boxes, black - 2 modules

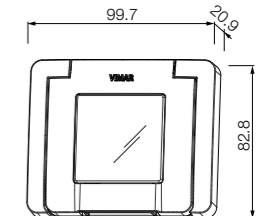

▲ 09911..



▲ 09912.01
with screws, for mounting boxes with 60 mm distance between centres, white - 2 modules



▲ 09912.04
with screws, for mounting boxes with 60 mm distance between centres, black - 2 modules

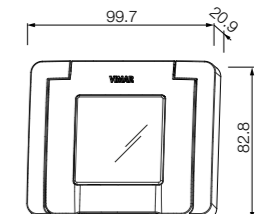

▲ 09912..

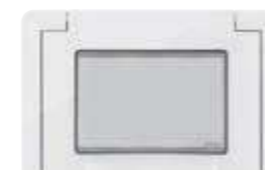

09913.01
with screws, for mounting boxes 3 modules, white - 3 modules



09913.04
with screws, for mounting boxes 3 modules, black - 3 modules

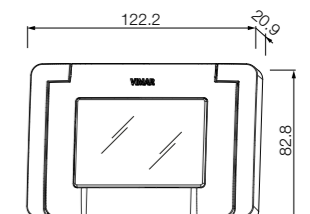

09913..



09914.01
with screws, for mounting boxes 4 modules, white - 4 modules

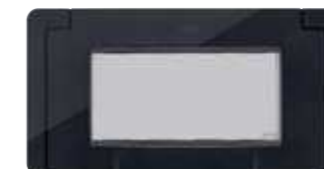

09914.04
with screws, for mounting boxes 4 modules, black - 4 modules

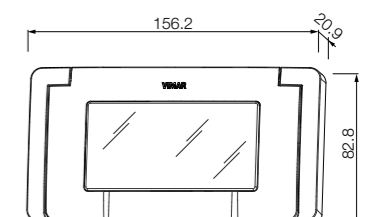

09914..

Glossy
(Technopolymer)



01 White (Total Look)

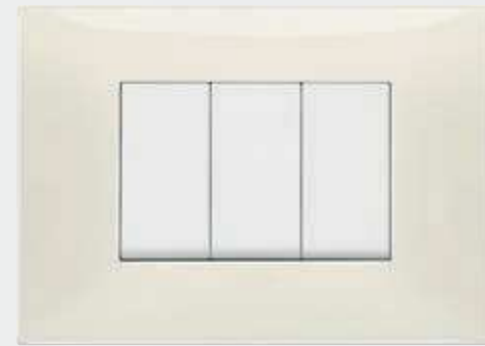

02 Ivory



03 Slate grey



04 Black

Matt
(Matt painted technopolymer)

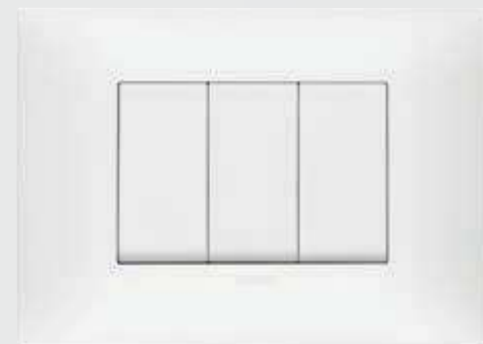

11 Matt white



12 Matt dove grey



13 Matt clay

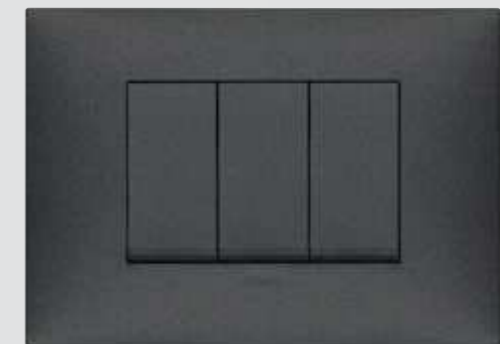

14 Carbon matt (Total Look)

Metal
(Metallic painted technopolymer)

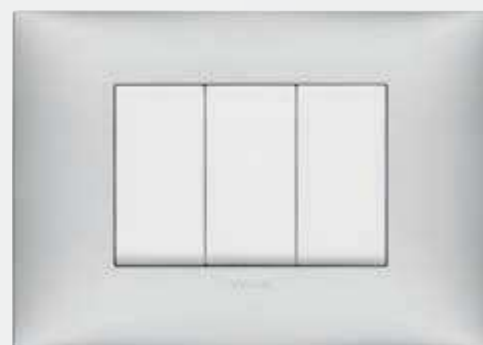

21 Matt silver



22 Matt nickel



23 Matt titanium

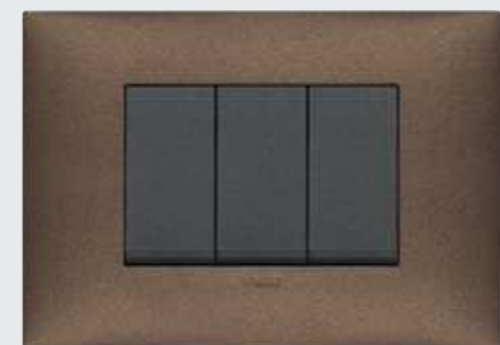

24 Matt copper

NEVE UP

Cover plates: guideline



	1-central-module	2-module	1-central-module	2-separate-module	2-central-module	3-module
Glossy (Technopolymer)						
White (Total Look)	09661.01	09662.01	09671.01	09679.01	09672.01	09673.01
Ivory	09661.02	09662.02	09671.02	09679.02	09672.02	09673.02
Slate grey	09661.03	09662.03	09671.03	09679.03	09672.03	09673.03
Black	09661.04	09662.04	09671.04	09679.04	09672.04	09673.04
Matt (Matt painted technopolymer)						
Matt white	09661.11	09662.11	09671.11	09679.11	09672.11	09673.11
Matt dove grey	09661.12	09662.12	09671.12	09679.12	09672.12	09673.12
Matt clay	09661.13	09662.13	09671.13	09679.13	09672.13	09673.13
Carbon matt (Total Look)	09661.14	09662.14	09671.14	09679.14	09672.14	09673.14
Metal (Metallic painted technopolymer)						
Matt silver	09661.21	09662.21	09671.21	09679.21	09672.21	09673.21
Matt nickel	09661.22	09662.22	09671.22	09679.22	09672.22	09673.22
Matt titanium	09661.23	09662.23	09671.23	09679.23	09672.23	09673.23
Matt copper	09661.24	09662.24	09671.24	09679.24	09672.24	09673.24

NEVE UP

Cover plates: guideline



	3-blank-module	4-module	7-module	2+2-module (between centres 71 mm)	2+2+2-module (between centres 71 mm)	2+2+2+2-module (between centres 71 mm)
09670.01		09674.01	09677.01	09664.01	09666.01	09668.01
09670.02		09674.02	09677.02	09664.02	09666.02	09668.02
09670.03		09674.03	09677.03	09664.03	09666.03	09668.03
09670.04		09674.04	09677.04	09664.04	09666.04	09668.04
09670.11		09674.11	09677.11	09664.11	09666.11	09668.11
09670.12		09674.12	09677.12	09664.12	09666.12	09668.12
09670.13		09674.13	09677.13	09664.13	09666.13	09668.13
09670.14		09674.14	09677.14	09664.14	09666.14	09668.14
09670.21		09674.21	09677.21	09664.21	09666.21	09668.21
09670.22		09674.22	09677.22	09664.22	09666.22	09668.22
09670.23		09674.23	09677.23	09664.23	09666.23	09668.23
09670.24		09674.24	09677.24	09664.24	09666.24	09668.24









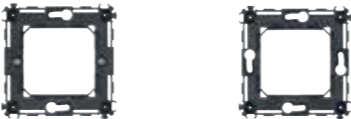

Types of mounting: Italian/American standard

Module	Box	Frame	Cover plate*
2-central for ø 60 mm and 3-module mounting box	<p>V71001 For masonry GW 650 °C, light blue V71001.AU GW 960 °C, black</p>	<p>09606 2-central module, for horizontal installation</p>	<p>09672... 2-central-module, for horizontal and vertical installation. Dimensions: 120x86x8,5 mm</p>
	<p>V71701 For hollow walls, for frame without claws, GW 850 °C, light blue</p>		
	<p>V71303 For masonry GW 650 °C, light blue V71303.AU GW 960 °C, black</p>		
3	<p>V71703 For hollow walls, GW 850 °C, light blue</p>	<p>09607 2-central module, for vertical installation</p>	<p>09672... 2-central-module, for horizontal and vertical installation. Dimensions: 120x86x8,5 mm</p>
	<p>4x2" mounting box</p>		
	<p>V71303 For masonry GW 650 °C, light blue V71303.AU GW 960 °C, black</p>		
3	<p>4x2" mounting box</p>	<p>09613 3-module</p>	<p>09671... 1-central-module. Dimensions: 120x86x8,9 mm</p>
	<p>V71303 For masonry GW 650 °C, light blue V71303.AU GW 960 °C, black</p>		
	<p>V71703 For hollow walls, GW 850 °C, light blue</p>		
3	<p>V71303 For masonry GW 650 °C, light blue V71303.AU GW 960 °C, black</p>	<p>09623 3-module, to use for installation of Plana devices</p>	<p>09679... 2-separate-module. Dimensions: 120x86x9 mm</p>
	<p>V71703 For hollow walls, GW 850 °C, light blue</p>		
	<p>4x2" mounting box</p>		

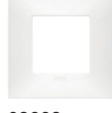
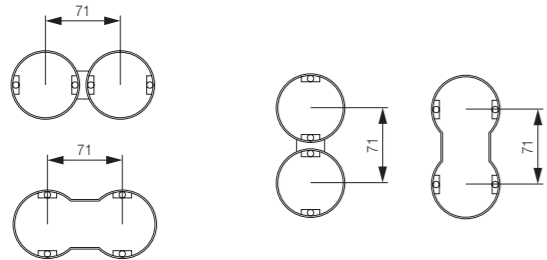
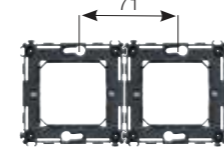
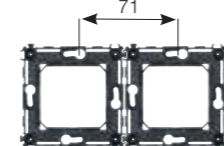
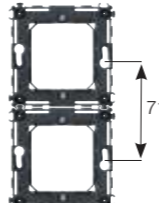
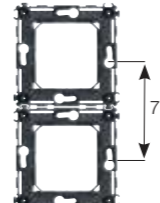
Module	Box	Frame	Cover plate*
3	<p>4x2" mounting box</p>	<p>09613 3-module</p>	<p>09673... 3-module. Dimensions: 120x86x8,5 mm</p>
	<p>V71303 For masonry GW 650 °C, light blue V71303.AU GW 960 °C, black</p>		
	<p>V71703 For hollow walls, GW 850 °C, light blue</p>		
4	<p>V71304 For masonry GW 650 °C, light blue V71304.AU GW 960 °C, black</p>	<p>09614 4-module</p>	<p>09674... 4-module. Dimensions: 142,4x86x8,4 mm</p>
	<p>V71704 For hollow walls, GW 850 °C, light blue</p>		
	<p>4x2" mounting box</p>		
7	<p>V71306 For masonry GW 650 °C, light blue V71306.AU GW 960 °C, black</p>	<p>09617 7-module</p>	<p>09677... 7-module. Dimensions: 210x86x8,4 mm</p>
	<p>V71706 For hollow walls, GW 850 °C, light blue</p>		
	<p>4x2" mounting box</p>		

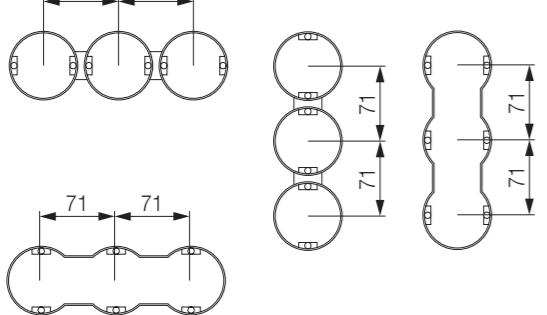
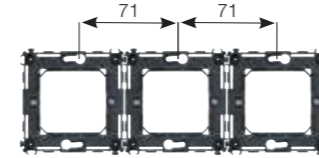
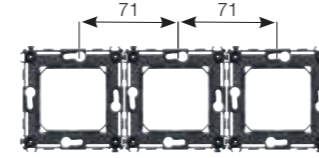
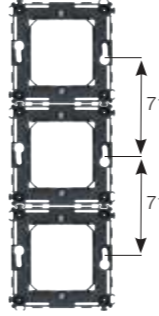
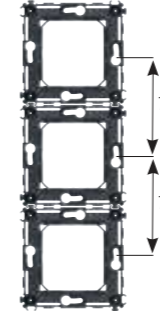
* Cover plates range, page 64

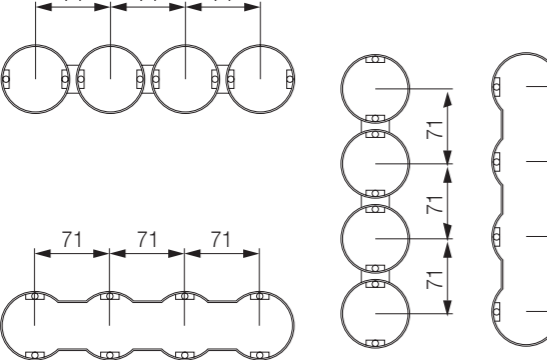
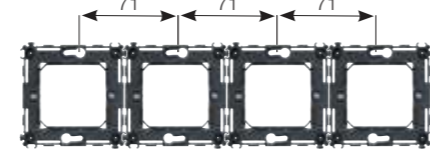
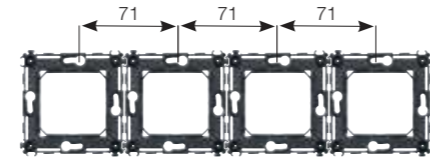
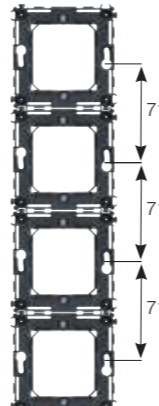
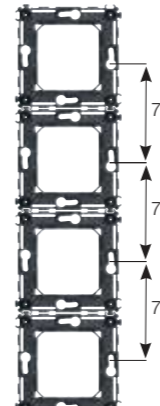
Types of mounting: German/French standard

Module	Box	Frame	Cover plate*
1 for ø 60 mm mounting box	 <p>V71001 For masonry GW 650 °C, light blue V71001.AU GW 960 °C, black</p> <p>V71701 For hollow walls, for frame without claws, GW 850 °C, light blue</p>	 <p>09602.1 2-module, with claws</p>  <p>09603.1 2-module, without screws</p>	 <p>09661... 1-central-module. Dimensions: 86x86x8,8 mm</p>
2 for ø 60 mm mounting box		 <p>09602.1 2-module, with claws</p>  <p>09603.1 2-module, without screws</p>	 <p>09662... 2-module. Dimensions: 86x86x8,5 mm</p>
2+2 71 mm between centres		 <p>2 x 09602.1 2-module, with claws</p>  <p>2 x 09603.1 2-module, without screws</p>  <p>2 x 09602.1 2-module, with claws</p>  <p>2 x 09603.1 2-module, without screws</p>	 <p>09664... 4-module (2+2), for horizontal and vertical installation. Dimensions: 157x86x8,5 mm</p>
2+2+2 71 mm between centres		 <p>3 x 09602.1 2-module, with claws</p>  <p>3 x 09603.1 2-module, without screws</p>  <p>3 x 09602.1 2-module, with claws</p>  <p>3 x 09603.1 2-module, without screws</p>	 <p>09666... 6-module (2+2+2), for horizontal and vertical installation. Dimensions: 228x86x8,5 mm</p>
2+2+2+2 71 mm between centres		 <p>4 x 09602.1 2-module, with claws</p>  <p>4 x 09603.1 2-module, without screws</p>  <p>4 x 09602.1 2-module, with claws</p>  <p>4 x 09603.1 2-module, without screws</p>	 <p>09668... 8-module (2+2+2+2), for horizontal and vertical installation. Dimensions: 299x86x8,5 mm</p>

* Cover plates range, page 64

Cover plates and devices customisation

Cover plates: customisation positions

(see area in grey)

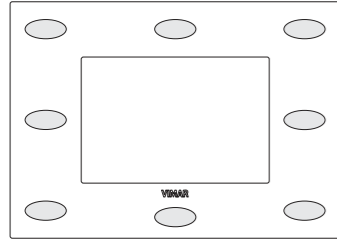

Example of customised cover plate



Controls and buttons: positions and features

Type	Customisation position*	Backlit customisation	Not backlit customisation
1-module controls and interchangeable buttons		NO	The entire button area can be customised
Lightable 1-module controls and interchangeable buttons 09021.N and 09021.N.CM		NO	positions 1 and 2
Lightable 1-module controls and interchangeable buttons 09021.G and 09021.G.CM		position 3	positions 1 and 2
2-module controls and interchangeable buttons		NO	The entire button area can be customised
Lightable 2-module controls and interchangeable buttons 09022.N and 09022.N.CM		NO	positions 1, 2 and 3

Example of customised controls and buttons



Neve Up - White: backlighting controls and interchangeable buttons



Neve Up - Carbon matt: backlighting controls and interchangeable buttons

* when position is not indicated, the customization is possible in the whole area of the button/control

Indications for customisation

- all devices, buttons and cover plates are customized depending on conditions described below;
- if the required customisation is including in the 'Library of standard symbols and wording', indicate the item code + symbol/wording code, **if the customisation is not included in the table check its feasibility with the sales network.**
- the **visible in darkness** customization is possible only in symbol engraved buttons and with diffuser (e.g. 09021.G and 09021.G.CM).

The few limits of technology

- it is not possible to reproduce coloured images.

What to supply

- an image in EPS or DXF format of the subject to be reproduced, minimum line width and minimum distance between lines: 0.5 mm.

How to proceed

- deliver all the documentation to your area wholesaler/distributor, who will then forward it to Vimar.

Library of standard symbols and wording (♦ symbols already on product catalogue visible in darkness)

ACCESSES														
LIGHTING														
ROLLER SHUTTERS														
CLIMATE						IRRIGATION								
SCENARIOS														
MUSIC AND AUDIO														
NUMBERS AND TEXTS														
HOTEL														

Smart card customization

The rear of the card can be customised on request, by providing a digital image of the subject in eps, tiff or jpg format.





Beauty. Energy. Life

Since 1945 our energy is driven by passion and are engaged in supporting the evolution of living styles. The heart of our company, where we create, design, manufacture and test all our products, is in the North East of Italy. We continue manufacturing here at Marostica: from materials to shapes, colour combinations to electronic processes, we are distinguished by quality, style and technology that speak our language all over the world. A long tradition and history of success, a culture based on solid and true values.

Research. Technology. Simplicity

To ensure the best of technology and design, 6% of our annual turnover is invested in R&D. This has allowed us over the years to lodge more than 180 patents worldwide, reflecting the attention of the great innovation like the little details that make every day life more simple and comfortable. We firmly believe that new ideas are created to be shared.

Taking care of the process

Our manufacturing cycle is characterized by low environmental impact. We recycle 60% of the plastic material waste and most of the metal. We only use water-based paints or UV curing. We are replacing the electroplating bath with the innovative and more environmentally friendly MSD process that eliminates any type of harmful emissions.



SICURY patent

On 15 March 1968 we patented our idea for the SICURY shutter, an essential device for ensuring the safety of electrical systems and protecting sockets, by preventing users from making involuntary contact with live parts. And since we firmly believe that new ideas are created to be shared, we decided to grant all the operators in the industry the right to use our patent free of charge, making SICURY a market standard that has been making the lives of children and their parents a little safer for the past 50 years.

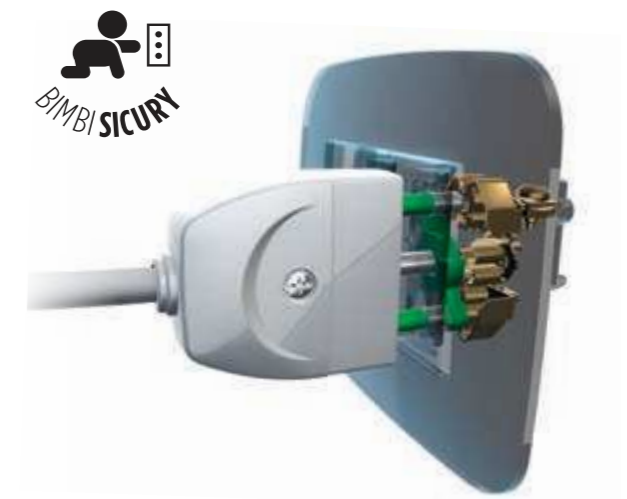

Energia Positiva. Insieme

