



TOPMET®

2023

LED profiles
Profile LED
LED-Profile
Profilés à LED

ACCESSORIES FOR LED SYSTEM - DIFFUSERS

SYSTEMOWE AKCESORIA LED - KLOSZE

ZUBEHÖR FÜR LED-SYSTEME - ABDECKUNGEN

ACCESSOIRES POUR SYSTEMES LED - DIFFUSEURS

A
slide
wsuwany
einschiebbar
coulissant

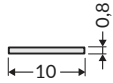

→ 194

A1 **NEW**
slide
wsuwany
einschiebbar
coulissant

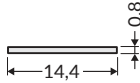

→ 194

A9
slide
wsuwany
einschiebbar
coulissant

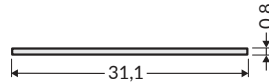

→ 194

B
slide
wsuwany
einschiebbar
coulissant

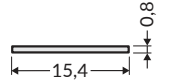

→ 194

C **NEW BLACK** **NEW 20 m**
click
klik
einclipbar
clik

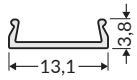

→ 195

C¹
click lens gen2
klik soczewka gen2
einclipbar Linse gen2
clik lentille gen2

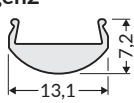

→ 195

C1
click
klik
einclipbar
clik

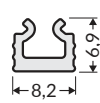

→ 195

C2 **NEW BLACK** **NEW 20 m**
click
klik
einclipbar
clik

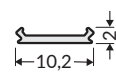

→ 196

C3 **NEW BLACK**
click
klik
einclipbar
clik

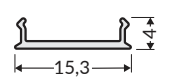

→ 196

C4
click
klik
einclipbar
clik

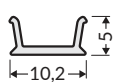

→ 196

C9 **NEW BLACK**
click
klik
einclipbar
clik

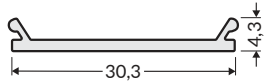

→ 197

click
klik
einclipbar
clik

C10¹ OPAL

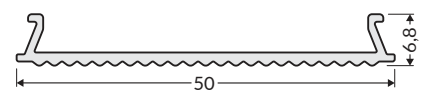

C10² NARROW

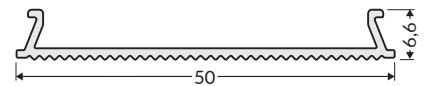

C10³ WIDE

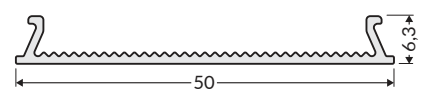

→ 197

D
click
klik
einclipbar
clik

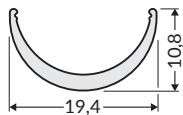

→ 198

D9
click
klik
einclipbar
clik

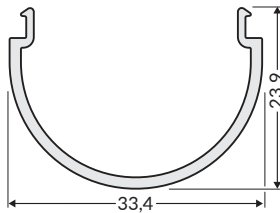

→ 198

E
slide
wsuwany
einschiebbar
coulissant

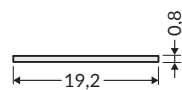

→ 198

E7
click
klik
einclipbar
clik

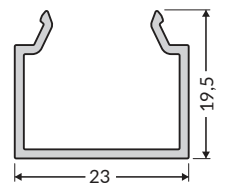

→ 198

E9
click
klik
einclipbar
clik

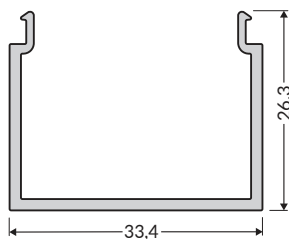

→ 199

F **NEW BLACK** **NEW 20 m**
click
klik
einclipbar
clik



→ 199

G
slide
wsuwany
einschiebbar
coulissant

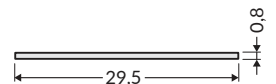

→ 199

H
slide
wsuwany
einschiebbar
coulissant

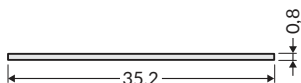

→ 200

I
click
klik
einclipbar
clik

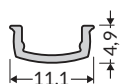

→ 200

J
slide
wsuwany
einschiebbar
coulissant

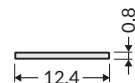

→ 200

K
click
klik
einclipbar
clik

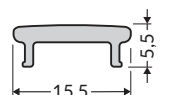

→ 200

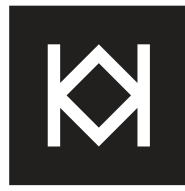

TOPMET[®]

2023

LED profiles
Profile LED
LED-Profile
Profilés à LED

TUTORIAL
KROK PO KROKU
SCHRITT FÜR SCHRITT
ÉTAPE PAR ÉTAPE
→ 6

SURFACE
NAWIERZCHNIOWE
AUFBAUPROFILE
SURFACE
→ 31

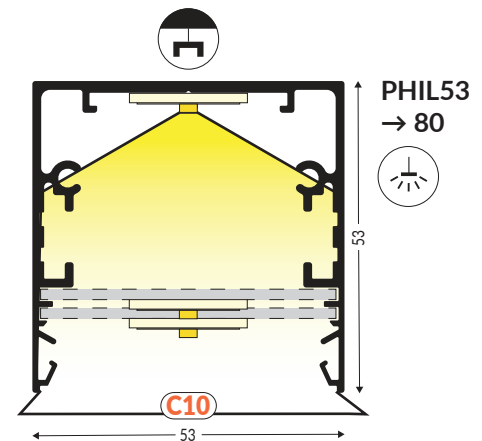
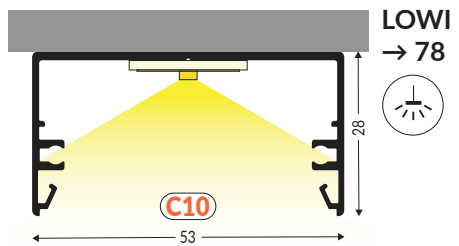
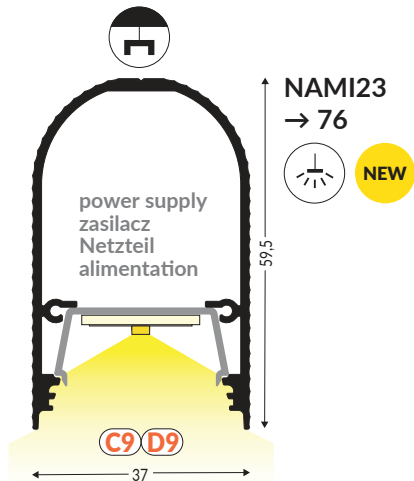
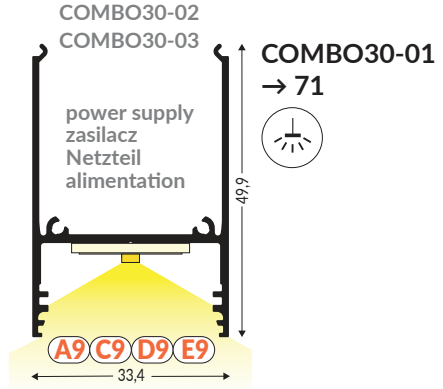
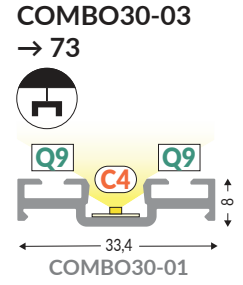
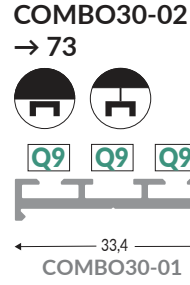
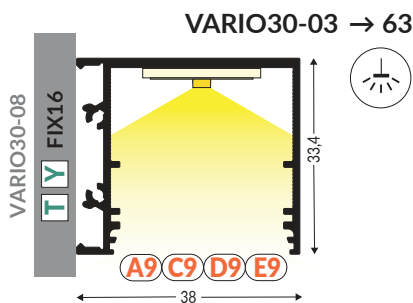
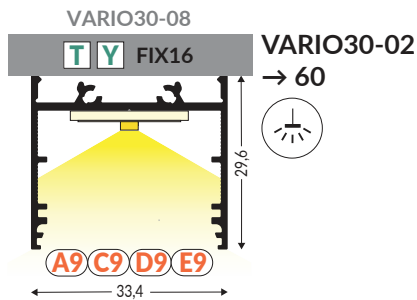
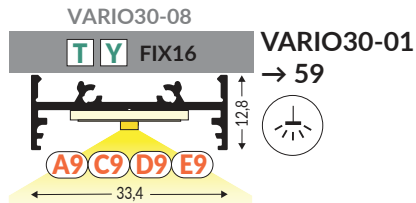
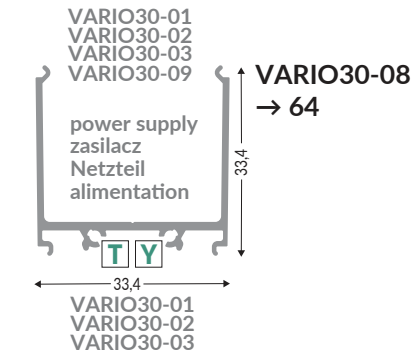
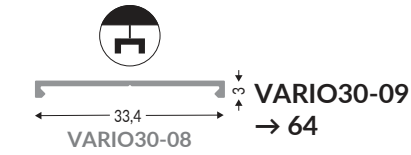
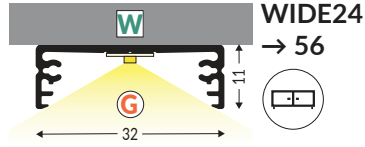
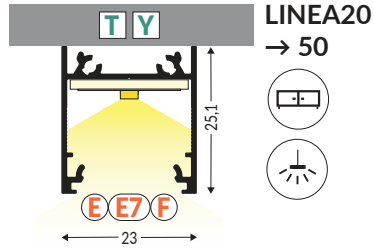
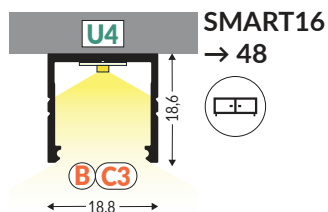
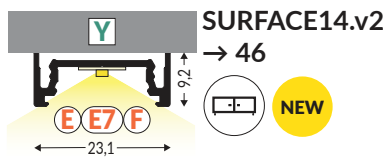
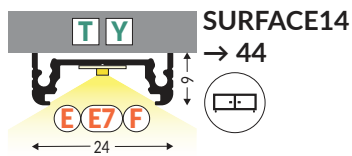
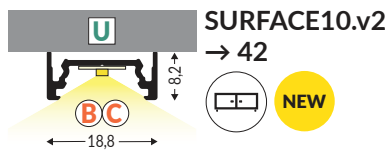
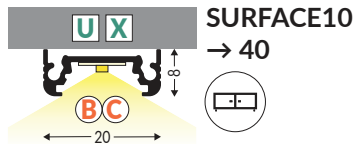
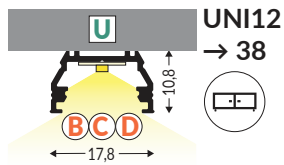
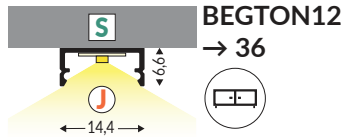
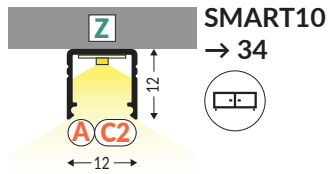
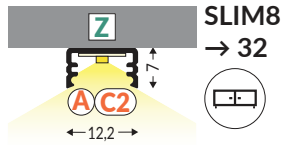

RECESSED
WPUSTOWE
EINBAUPROFILE
A ENCASTRER
→ 83

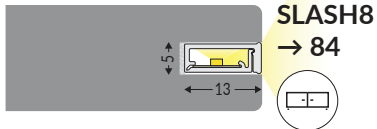

SLASH8
→ 84

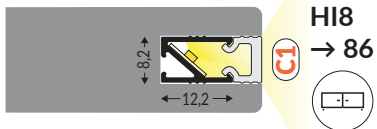

HI8
→ 86

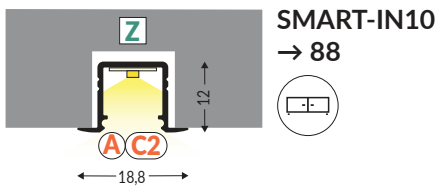

SMART-IN10
→ 88

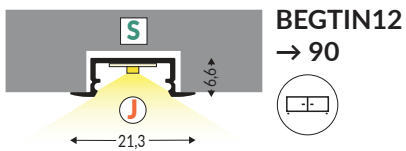

BEGTIN12
→ 90

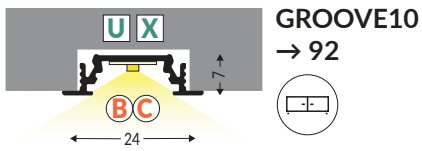

GROOVE10
→ 92

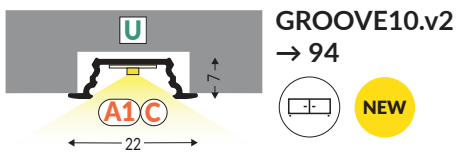

GROOVE10.v2
→ 94

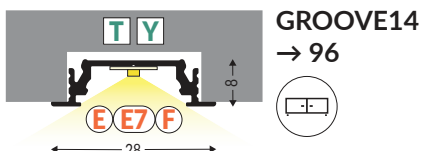

GROOVE14
→ 96

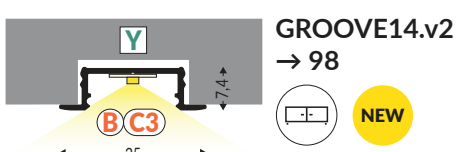

GROOVE14.v2
→ 98

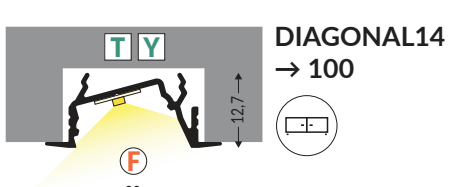

DIAGONAL14
→ 100

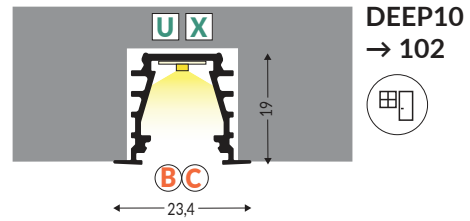

DEEP10
→ 102

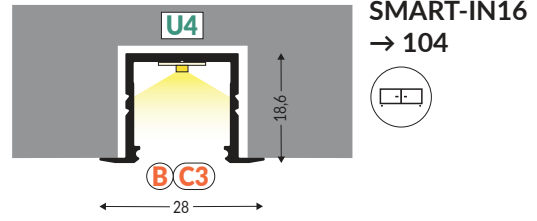

SMART-IN16
→ 104

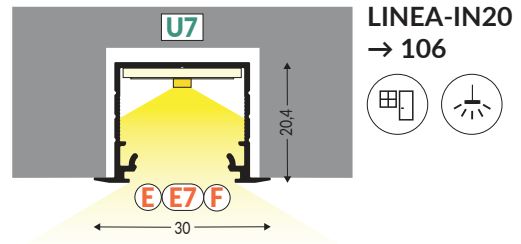

LINEA-IN20
→ 106

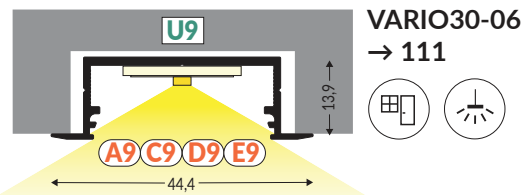

VARIO30-06
→ 111

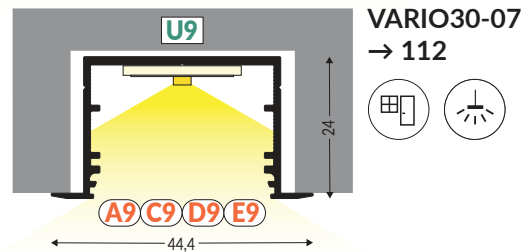

VARIO30-07
→ 112

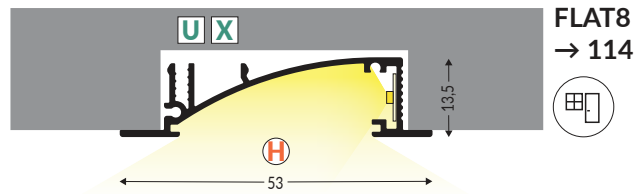

FLAT8
→ 114

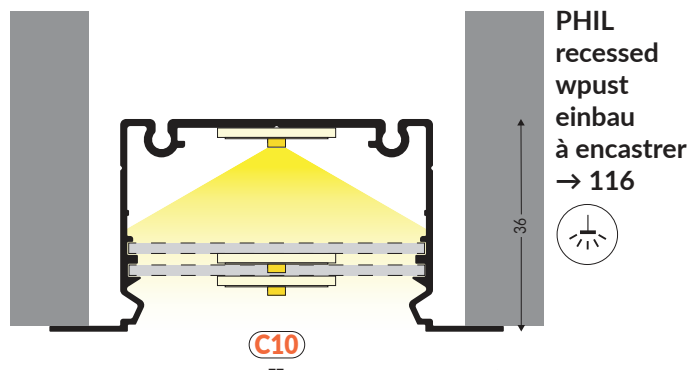

PHIL
recessed
wput
einbau
à encastrer
→ 116

**CORNER
KĄTOWE
ECKPROFILE
D'ANGLES**
→ 119

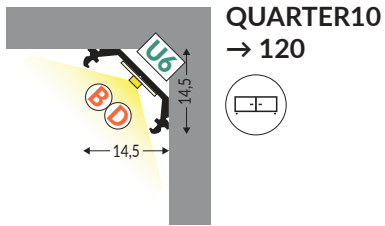

QUARTER10
→ 120

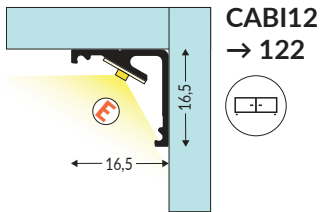

CABI12
→ 122

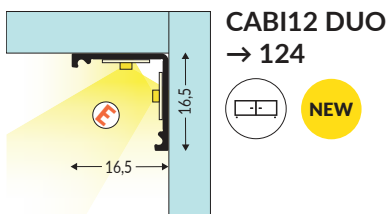

CABI12 DUO
→ 124

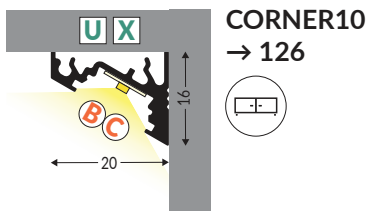

CORNER10
→ 126

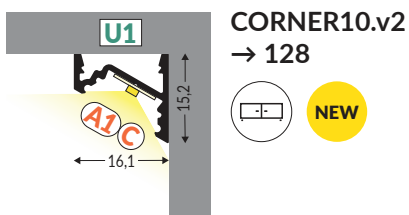

CORNER10.v2
→ 128

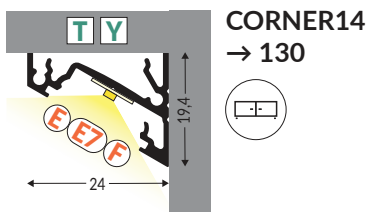

CORNER14
→ 130

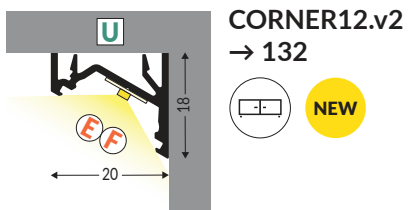

CORNER12.v2
→ 132

**PLASTER-IN
DO SZPACHLOWANIA
ZUM SPACHELN
POUR LE REMPLISSAGE**
→ 135

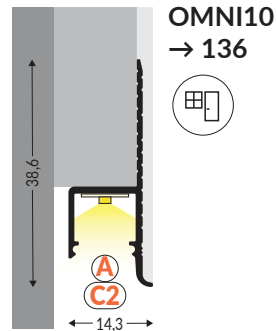

OMNI10
→ 136

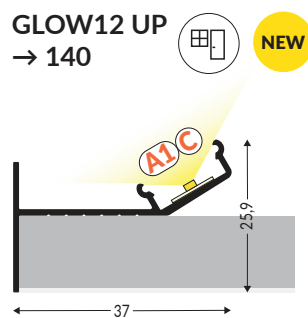

GLOW12 UP
→ 140

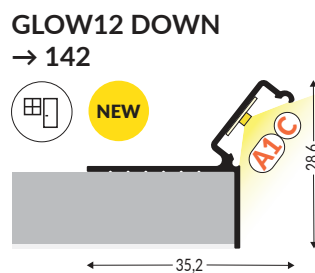

GLOW12 DOWN
→ 142

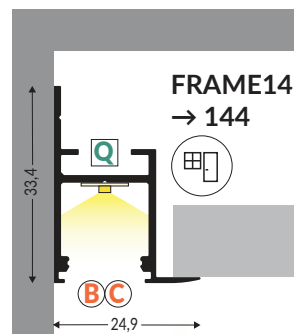

FRAME14
→ 144

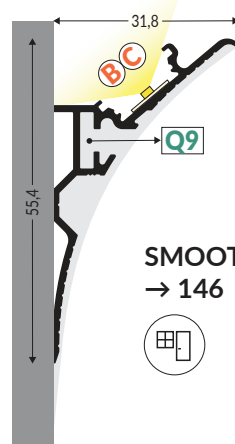

SMOOTH12
→ 146

HIDE10
→ 148

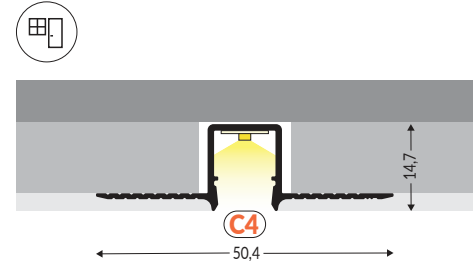

LINEA-IN20 TRIMLESS
→ 150

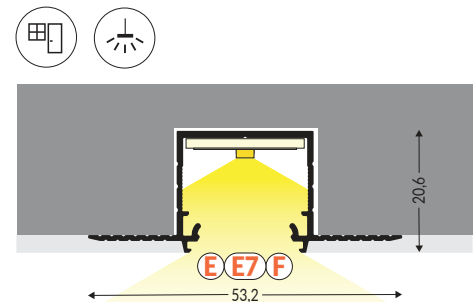

VARIO30-04
→ 153

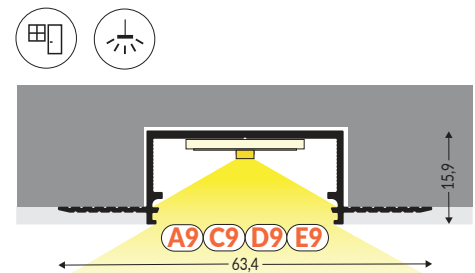

VARIO30-05
→ 154

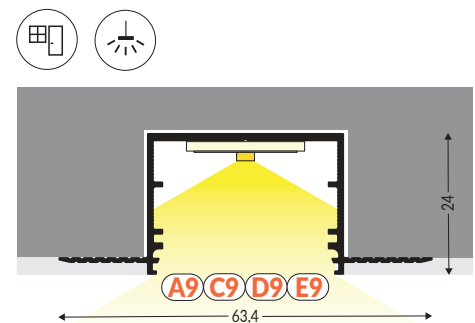

**TILE-IN
DO PŁYTEK
FÜR FLIESEN
POUR LES CARREAUX**
→ 157

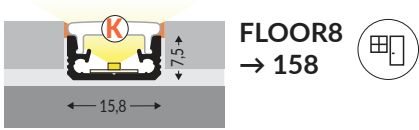

FLOOR8
→ 158

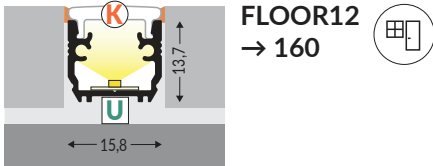

FLOOR12
→ 160

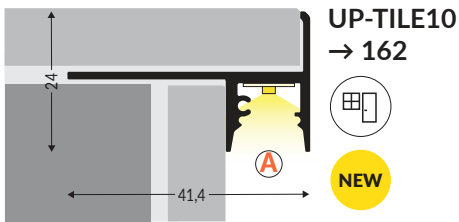

UP-TILE10
→ 162

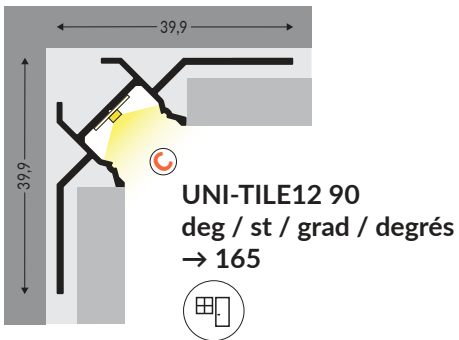

UNI-TILE12 90
deg / st / grad / degrés
→ 165

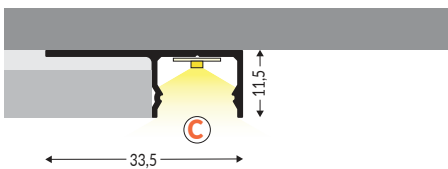

UNI-TILE12 180
deg / st / grad / degrés
→ 166

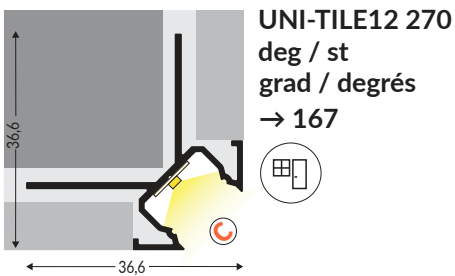

UNI-TILE12 270
deg / st / grad / degrés
→ 167

**SPECIAL APPLICATION
SPECJALNY
SPEZIELLE PROFILE
SPÉCIAL**
→ 169

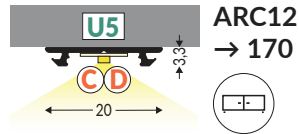

ARC12
→ 170

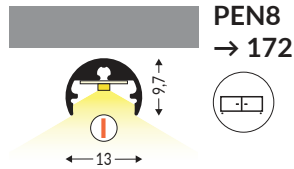

PEN8
→ 172

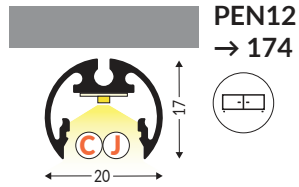

PEN12
→ 174

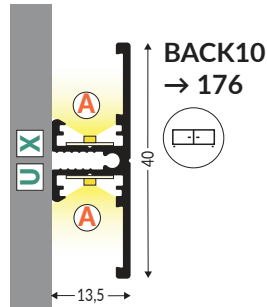

BACK10
→ 176

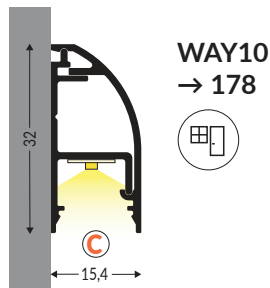

WAY10
→ 178

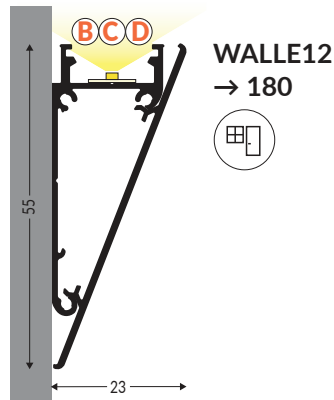

WALLE12
→ 180

UP-MINI10
→ 182

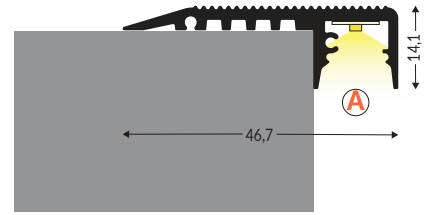

UP-BOLD12
→ 184

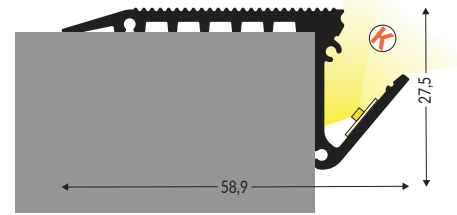

SKIRT10
→ 186

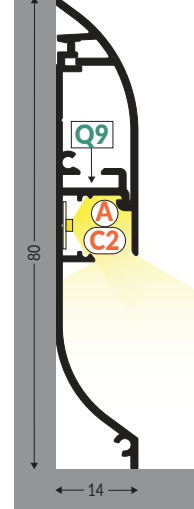

BASE
→ 188

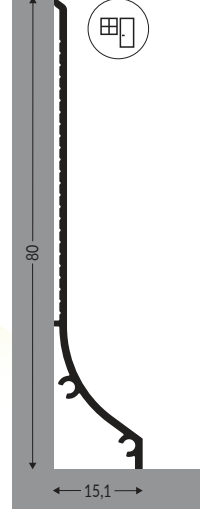

FIX12
→ 191

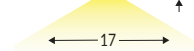

FIX16
→ 191



**ACCESSORIES
AKCESORIA
ZUBEHÖR
ACCESSOIRES**
→ 193

Designing, manufacturing, illuminating since 1989

Projektujemy, produkujemy, oświetlamy od 1989

Wir entwerfen, herstellen, beleuchten seit 1989

Conception fabrication d'éclairage depuis 1989

TOPMET Light has been operating in the lighting industry for more than 30 years. We create products adapted to the changing technologies and follow micro and macro trends. We never cease to look for new possibilities and inspire.

Firma TOPMET Light działa w branży oświetleniowej od ponad 30 lat. Tworzymy produkty uwzględniające zmieniające się technologie, śledzimy trendy mikro i makro. Nieustannie poszukujemy nowych możliwości i inspirujemy.

Das Unternehmen TOPMET Light ist in der Beleuchtungsbranche seit über 30 Jahren tätig. Wir entwickeln Produkte, die neue Technologien berücksichtigen und beobachten die Mikro- und Makrotrends. Ständig suchen wir nach neuen Möglichkeiten und sind eine Inspiration.

TOPMET est présent dans le secteur d'éclairage depuis près de 30 ans. Nous créons des produits adaptés aux technologies qui se transforment et suivons les micro- et macro-tendances. Nous ne cessons pas de chercher de nouvelles possibilités et d'inspirer.



In the recent years, our offer has been dominated by the idea of creating various effects with the use of the LED profiles range and compatible accessories. We follow trends and offer innovative solutions that help create reality.

I tak przez ostatnie lata dominuje w naszej ofercie idea tworzenia różnorodnych efektów z wachlarza profili LED oraz kompatybilnych akcesoriów. Obserwujemy trendy i proponujemy innowacyjne rozwiązania, które pomagają kreować rzeczywistość.

In den letzten Jahren wurde unser Angebot von einem Konzept beherrscht, verschiedene Effekte aus der Palette der LED-Profile und kompatibler Ausrüstung zu erzeugen. Wir beobachten die Trends und schlagen innovative Lösungen vor, mit denen die Realität mitgestaltet wird.

Depuis quelques années, notre offre est dominée par l'idée de créer une variété d'effets à partir de la gamme de profils LED et des accessoires compatibles. Nous suivons les tendances et proposons des solutions innovantes qui contribuent à la création de la réalité.

Hundreds of components, thousands of lighting ideas Setki komponentów, tysiące pomysłów na oświetlenie Hunderte von Komponenten, tausende von Beleuchtungs-ideen Des centaines de composants, des milliers d'idées d'éclairage

Our products are our own projects and registered designs made in Europe.
Our offer is clear and systemic.
Thanks to the development of our staff and machinery we introduce new technologies, optimise production and logistics.
We provide extensive sales support—from the convenient B2B platform to sample displays.

We participate in the most important lighting trade fairs.

Nasze produkty to autorskie projekty, wzory zastrzeżone i produkcja europejska.
Nasza oferta jest czytelna i systemowa.
Dzięki rozwojowi kadry i parku maszynowego, wprowadzamy kolejne technologie, optymalizujemy produkcję i logistykę.
Zapewniamy szerokie wsparcie sprzedażowe – począwszy od wygodnej platformy B2B, a na ekspozytorach z próbkami skończywszy.

Wystawiamy się na najważniejszych imprezach targowych z branży oświetleniowej.

Unsere Produkte sind Eigenprodukte, Muster vorbehalten und europäische Produktion.
Unser Angebot ist transparent und wird als Systemangebot vorgeschlagen.
Dank Entwicklung des Personals und des Maschinenparks werden weitere Technologien eingeführt, die Herstellung und die Logistik werden optimiert.
Wir bieten umfangreiche Verkaufsunterstützung - angefangen von einer bequemen B2B-Plattform, über Ausstellungsstände, bis auf Warenmuster.

Wir sind auf den bedeutendsten Messen in der Beleuchtungsbranche präsent.

Nos produits, c'est de conceptions originales et modèles déposés, tous produits en Europe.
Notre offre est claire et méthodique.
Grâce au développement du personnel et des machines, nous introduisons de nouvelles technologies et optimisons la production et la logistique.
Nous fournissons le soutien commercial – en commençant par la plateforme B2B pratique jusqu'aux présentoirs d'échantillons.
Nous sommes présents aux foires commerciales d'éclairage les plus importantes.

TOPMET IN THE WORLD

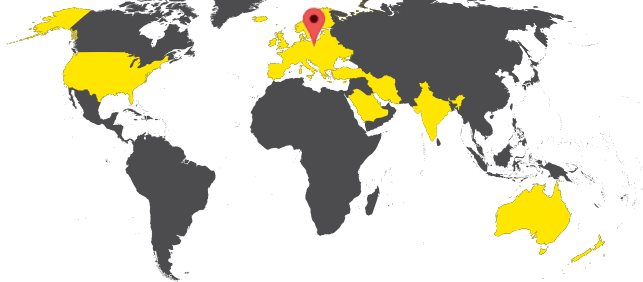

We are a reliable manufacturer and supplier with headquarters in central Europe.
We reach almost 70 countries around the globe and continue to expand our cooperation network.
We guarantee short order lead times thanks to fully stocked warehouses and convenient logistics.
Create light with the TOPMET products!

Jesteśmy stabilnym producentem i dostawcą z siedzibą w centrum Europy.
Docieramy do ponad 70 krajów na całym świecie i ciągle rozwijamy sieć współpracy.
Zapewniamy krótki czas realizacji zamówień, dzięki pełnym magazynom oraz wygodnej logistyce.

Kreuj światło z produktami TOPMET!

Wir sind ein stabiler Hersteller und Lieferant mit Sitz im Zentrum Europas. Wir beliefern über 70 Länder auf der ganzen Welt und das Kooperationsnetz wird kontinuierlich weiterentwickelt.
Wir bieten schnelle Abwicklung von Aufträgen dank ausreichenden Lagerbeständen und optimaler Logistik.
Kreieren Sie das Licht mit den Produkten von TOPMET!

TOPMET est un fabricant et fournisseur fiable établi en Europe centrale.
Nous desservons plus de 70 pays du monde et nous continuons d'élargir notre réseau de coopération.
Nous garantissons des délais de livraison courts, grâce aux entrepôts bien remplis et une logistique pratique.
Créez la lumière avec les produits de TOPMET!

ACCESSORIES FOR LED SYSTEM - DIFFUSERS

SYSTEMOWE AKCESORIA LED - KLOSZE

ZUBEHÖR FÜR LED-SYSTEME - ABDECKUNGEN

ACCESSOIRES POUR SYSTEMES LED - DIFFUSEURS

	A	A1	A9	B	C	C1	C2	C3	C4	C9	C10	D	D9	E	E7	E9	F	G	H	I	J	K	
SLIM8 AC2/Z → 32	■						■																
SMART10 AC2/Z → 34	■						■																
BEGTON12 J/S → 36																						■	
UNI12 BCD/U → 38				■	■							■											■
SURFACE10 BC/UX → 40				■	■																		
SURFACE10.v2 BC/U → 42				■	■																		
SURFACE14 EE7F/TY → 44															■	■		■					
SURFACE14.v2 EE7F/Y → 46															■	■		■					
SMART16 BC3/U4 → 48				■						■													
LINEA20 EE7F/TY → 50															■	■		■					
WIDE24 G/W → 56															■	■			■				
VARIO30-01 ACDE-9/TY → 59			■							■				■			■						
VARIO30-02 ACDE-9/TY → 60			■							■				■			■						
VARIO30-03 ACDE-9/TY → 63			■							■				■			■						
COMBO30-01 ACDE-9 → 71			■							■				■			■						
COMBO30-02 Q9 → 73																							
COMBO30-03 C4/Q9 → 73									■														
NAMI23 CD-9 → 76									■	■				■									
LOWI C10 → 78													■										
PHIL53 C10 → 80												■											
SLASH8 → 84																							
HI8 C1 → 86							■																
SMART-IN10 AC2/Z → 88	■							■															
BEGTIN12 J/S → 90																						■	
GROOVE10 BC/UX → 92				■	■																		
GROOVE10.v2 A1C/U → 94		■		■	■																		
GROOVE14 EE7F/TY → 96															■	■		■					
GROOVE14.v2 BC3/Y → 98									■						■	■		■					
DIAGONAL14 F/TY → 100																							
DEEP10 BC/UX → 102				■	■																		
SMART-IN16 BC3/U4 → 104				■					■														
LINEA-IN20 EE7F/U7 → 106															■	■		■					
VARIO30-06 ACDE-9/U9 → 111			■							■				■			■						
VARIO30-07 ACDE-9/U9 → 112			■							■				■			■						
FLAT8 H/UX → 114																					■		
PHIL recessed/ wpust / Einbau / entree C10 → 116													■										
QUARTER10 BD/U6 → 120				■									■										
CABI12 E → 122																							
CABI12 DUO E → 124																							
CORNER10 BC/UX → 126				■	■																		
CORNER10.v2 A1C/U1 → 128		■		■	■																		
CORNER14 EE7F/TY → 130															■	■		■					
CORNER12.v2 EF/U → 132															■	■		■					
OMNI10 AC2 → 136	■									■													
GLOW12 UP A1C → 140		■			■																		
GLOW12 DOWN A1C → 142		■			■																		
FRAME14 BC/Q → 144				■	■																		
SMOOTH12 BC/Q9 → 146				■	■																		
HIDE10 C4 → 148										■													
LINEA-IN20 TRIMLESS EE7F → 150															■	■		■					
VARIO30-04 ACDE-9 → 153			■								■			■			■						
VARIO30-05 ACDE-9 → 154			■								■			■			■						
FLOOR8 K → 158																							■
FLOOR12 K/U → 160																							■
UP-TILE10 A → 162	■																						
UNI-TILE12 90 deg / st / Grad / degrés C → 165					■	■																	
UNI-TILE12 180 deg / st / Grad / degrés C → 166					■	■																	
UNI-TILE12 270 deg / st / Grad / degrés C → 167					■	■																	
ARC12 CD/U5 → 170													■										
PEN8 I → 172																						■	
PEN12 CJ → 174																						■	
BACK10 A/UX → 176	■																						
WAY10 C → 178																							
WALLE12 BCD → 180				■	■								■										
UP-MINI10 A → 182	■																						
UP-BOLD12 K → 184																							■
SKIRT10 AC2/Q9 → 186	■																						■

ACCESSORIES FOR LED SYSTEM - MOUNTINGS

SYSTEMOWE AKCESORIA LED - MOCOWANIA

ZUBEHÖR FÜR LED-SYSTEME - HALTER

ACCESSOIRES POUR SYSTEMES LED - FIXATIONS

	Q	Q9	S	T	U	U1	U4	U5	U6	U7	U9	W	X	Y	Z
SLIM8 AC2/Z → 32															
SMART10 AC2/Z → 34															
BEGTON12 J/S → 36															
UNI12 BCD/U → 38															
SURFACE10 BC/UX → 40															
SURFACE10.v2 BC/U → 42															
SURFACE14 EE7F/TY → 44															
SURFACE14.v2 EE7F/Y → 46															
SMART16 BC3/U4 → 48															
LINEA20 EE7F/TY → 50															
WIDE24 G/W → 56															
VARIO30-01 ACDE-9/TY → 59															
VARIO30-02 ACDE-9/TY → 60															
VARIO30-03 ACDE-9/TY → 63															
COMBO30-01 ACDE-9 → 71															
COMBO30-02 Q9 → 73															
COMBO30-03 C4/Q9 → 73															
NAMI23 CD-9 → 76															
LOWI C10 → 78															
PHIL53 C10 → 80															
SLASH8 → 84															
HI8 C1 → 86															
SMART-IN10 AC2/Z → 88															
BEGTIN12 J/S → 90															
GROOVE10 BC/UX → 92															
GROOVE10.v2 A1C/U → 94															
GROOVE14 EE7F/TY → 96															
GROOVE14.v2 BC3/Y → 98															
DIAGONAL14 F/TY → 100															
DEEP10 BC/UX → 102															
SMART-IN16 BC3/U4 → 104															
LINEA-IN20 EE7F/U7 → 106															
VARIO30-06 ACDE-9/U9 → 111															
VARIO30-07 ACDE-9/U9 → 112															
FLAT8 H/UX → 114															
PHIL recessed/ wpust / Einbau / entrée C10 → 116															
QUARTER10 BD/U6 → 120															
CABI12 E → 122															
CABI12 DUO E → 124															
CORNER10 BC/UX → 126															
CORNER10.v2 A1C/U1 → 128															
CORNER14 EE7F/TY → 130															
CORNER12.v2 EF/U → 132															
OMNI10 AC2 → 136															
GLOW12 UP A1C → 140															
GLOW12 DOWN A1C → 142															
FRAME14 BC/Q → 144															
SMOOTH12 BC/Q9 → 146															
HIDE10 C4 → 148															
LINEA-IN20 TRIMLESS EE7F → 150															
VARIO30-04 ACDE-9 → 153															
VARIO30-05 ACDE-9 → 154															
FLOOR8 K → 158															
FLOOR12 K/U → 160															
UP-TILE10 A → 162															
UNI-TILE12 90 deg / st / Grad / degrés C → 165															
UNI-TILE12 180 deg / st / Grad / degrés C → 166															
UNI-TILE12 270 deg / st / Grad / degrés C → 167															
ARC12 CD/U5 → 170															
PEN8 I → 172															
PEN12 CJ → 174															
BACK10 A/UX → 176															
WAY10 C → 178															
WALLE12 BCD → 180															
UP-MINI10 A → 182															
UP-BOLD12 K → 184															
SKIRT10 AC2/Q9 → 186															

WHY LED PROFILES? DLACZEGO PROFILE LED? WARUM LED PROFILE? POURQUOI DES PROFILÉS LED ?

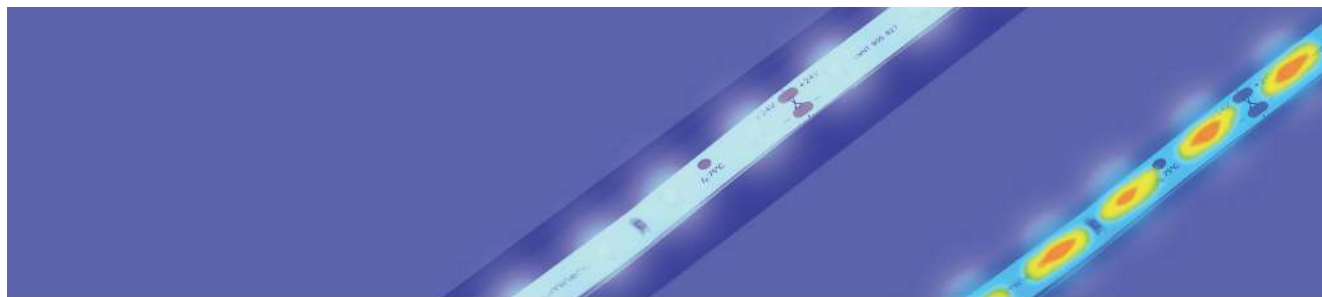

HEAT DISSIPATION

An aluminium profile is a radiator - it dissipates heat from the LED source. Lower temperature means better operating conditions for the diodes, therefore, extension of the LED lifespan and better illumination parameters. It also translates to economic considerations - LED does not require such frequent replacement of light sources. An aluminium profile is an investment, which pays off.

Some LED sources available on the market may exceed radiation capabilities of a given aluminium profile. In order to ensure correct operation, a LED source with appropriate parameters needs to be matched to an aluminium profile.

ODPROWADZANIE CIEPŁA

Profil aluminiowy jest radiatorem – odprowadza ciepło ze źródła LED. Niższa temperatura to lepsze warunki pracy dla diod, a tym samym przedłużenie żywotności LED i lepsze parametry świetlne. Przekłada się to również na względy ekonomiczne – LED nie wymaga tak częstych wymian źródeł światła. Profil aluminiowy to inwestycja, która się opłaca.

Niektóre źródła LED dostępne na rynku mogą przekraczać radiacyjne możliwości wybranego profilu aluminiowego. W celu zapewnienia poprawnego działania, należy dobrać do profilu aluminiowego źródło LED o odpowiednich parametrach.

WÄRMEABFUHR

Das LED Profil ist ein Radiator - es strahlt die Wärme aus der LED Lichtquelle ab. Eine niedrigere Temperatur bedeutet bessere Arbeitsbedingungen für die LEDs, was Einfluss auf ihre Lebensdauer hat und bessere Lichtparameter sichert. Das hat auch einen Einfluss auf den ökonomischen Aspekt, denn LED Lichtquellen müssen nicht so oft getauscht werden. Das LED Aluminiumprofil ist eine Investition, die sich lohnt.

Einige auf dem Markt zugängliche LED Lichtquellen, können die Wärmeabfuhrmöglichkeiten des gewählten Aluminiumprofils überschreiten. Damit das LED Profil richtig funktioniert, soll man eine LED Lichtquelle mit entsprechenden Lichtparametern wählen.

DISSIPATION DE LA CHALEUR

Le profilé en aluminium est un dissipateur de chaleur – il dissipe la chaleur de la source LED. Une température plus basse signifie de meilleures conditions de travail pour les LED et prolonge ainsi la durée de vie de la LED et assure de meilleurs paramètres d'éclairage. Cela se traduit également par des considérations économiques – la LED ne nécessite pas un remplacement aussi fréquent de la source lumineuse. Le profilé en aluminium est un investissement rentable.

Certaines sources LED disponibles sur le marché peuvent dépasser les capacités de rayonnement du profilé en aluminium sélectionné. Afin d'assurer un bon fonctionnement, une source LED doit être équipée d'un profilé en aluminium approprié.



AESTHETICS / STRIP PROTECTION

An aluminium profile is a protection for a LED source against mechanical damage. The assembly is much more durable in comparison to gluing a LED strip directly to the surface. Using a profile increases aesthetics and facilitates maintaining cleanliness.

ESTETYKA / OCHRONA TAŚMY

Profil aluminiowy stanowi zabezpieczenie źródła LED przed mechanicznym uszkodzeniem. Montaż jest znacznie trwalszy w porównaniu z przyklejeniem taśmy LED bezpośrednio do podłoża. Użycie profilu podwyższa estetykę oraz ułatwia utrzymanie czystości.

ÄSTHETIK / SCHUTZ DES LED STREIFENS

Das LED Aluminiumprofil bildet eine Art Schutz der LED Lichtquelle vor mechanischen Beschädigungen. Die Montage ist viel fester im Vergleich zum Ankleben. Das Anwenden von einem LED Profil erhöht die ästhetische Seite und sorgt für Sauberhaltung.

ESTHÉTIQUE / PROTECTION DU RUBAN

Le profilé en aluminium protège la source LED contre les dommages mécaniques. L'installation est beaucoup plus durable que de coller le ruban LED directement sur le support. L'utilisation du profilé augmente l'esthétique et facilite le nettoyage.

WHY LED PROFILES? DLACZEGO PROFILE LED? WARUM LED PROFILE? POURQUOI DES PROFILÉS LED ?

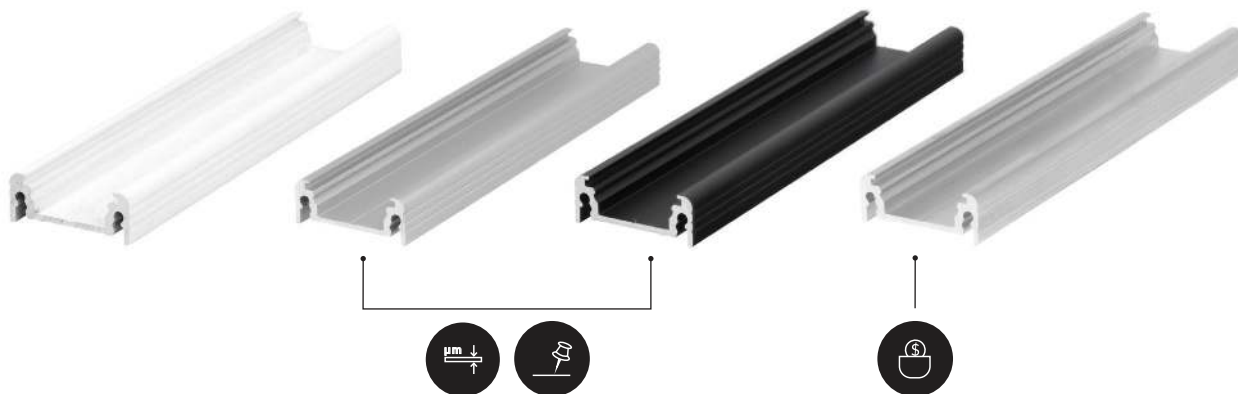

ANODIZED COATING COLOUR VERSIONS

In the standard TOPMET offer, aluminium LED profiles are available in 4 basic finishes:

- white painted - powder coated,
- anodised aluminium in silver colour,
- anodised aluminium in black colour,
- raw aluminium - economic version, not resistant to damage.

The most eagerly used ones are the anodized versions with a high degree of scratch resistance. The thickness of the anodic coating on all our profiles is about 15 µm.

ANODOWANA POWŁOKA WERSJE KOLORYSTYCZNE

W standardowej ofercie TOPMET profile aluminiowe LED występują w 4 podstawowych wykończeniach:

- biały malowany – powłoka farby proszkowej,
- aluminium anodowane w kolorze srebrnym,
- aluminium anodowane w kolorze czarnym,
- aluminium surowe – wersja ekonomiczna, nieodporna na uszkodzenia.

Najchętniej stosowane są wersje anodowane o wysokim stopniu odporności na zarysowania. Grubość powłoki anodowej na wszystkich naszych profilach to około 15 µm.

ELOXIERTE BESCHICHTUNG FARBVERSIONEN

TOPMET bietet standardmäßig die LED Profile in vier Ausführungen:

- Weiß lackiert - pulverbeschichtet,
- eloxiertes Aluminium in silbern,
- eloxiertes Aluminium in schwarz, weiß
- Rohaluminium - kostengünstige Variante, schadensanfällig.

Am meisten wird die eloxierte Version, mit einem hohen Grad der Beständigkeit gegen Kratzer angewendet. Die Dicke des Eloxals auf allen unseren Profilen liegt bei ca. 15 µm.

REVÊTEMENT ANODISÉ VERSIONS COULEURS

Dans l'offre TOPMET standard, les profilés aluminium LED sont disponibles en 4 finitions de base :

- peint en blanc – revêtement de peinture en poudre,
- aluminium anodisé argent,
- aluminium anodisé noir,
- aluminium brut – version économique, non résistant aux rayures.

Les versions les plus couramment utilisées sont les versions anodisées avec un haut degré de résistance aux rayures. L'épaisseur du revêtement anodique sur tous nos profilés est d'environ 15 µm.



ACCESSORIES

The design department is constantly working on expanding the offer with further components, which facilitate the assembly and multiply the possibilities of combinations, connections and assembly. Apart from system mounting plates, which match different profiles, many collections also have dedicated solutions for more advanced, specialist needs. The accessories for LED profiles include, i.a.: end caps, diffusers, mounting plates, holders, connectors, slings and many more.

AKCESORIA

Dział projektowy stale pracuje nad wzbogaceniem oferty w kolejne komponenty, które ułatwiają montaż i zwielokrotniają możliwości kombinacji, połączeń, montażu. Poza uchwytami systemowymi, pasującymi do różnych profili, wiele kolekcji ma także dedykowane rozwiązania do bardziej zaawansowanych, specjalistycznych potrzeb. Wśród akcesoriów do profili LED są m.in.: zaślepki, klosze, uchwyty, łączniki, zawieszki i wiele innych.

ZUBEHÖR

Unsere Projektabteilung arbeitet ständig an der Erweiterung des Angebotes um weitere Komponenten, die die Montage vereinfachen und die Kombinations-, Verbindungs- und Montagemöglichkeiten vervielfachen. Außer den Haltern, die mit mehreren Profilen kompatibel sind, haben viele Typen der Profile auch eigene Lösungen für mehr fortgeschrittene, spezielle Bedürfnisse. Unter den Zubehörteilen für LED Profile gibt es u.a. Endkappen, Abdeckungen, Halter, Ausleger, Verbinder, Klemmen, Abhängungen und viele andere.

ACCESSOIRES

Le bureau d'études travaille en permanence à enrichir l'offre avec de nouveaux composants qui facilitent l'assemblage et multiplient les possibilités de combinaisons, de connexions et d'assemblages. En plus des fixations système qui correspondent à différents profilés, de nombreuses collections ont également des solutions dédiées pour des besoins plus avancés et spécialisés. Parmi les accessoires pour profilés LED, on trouve, entre autres : des embouts, des diffuseurs, des fixations, des connecteurs, des dispositifs de suspension et bien d'autres.

DESIGN / PRODUCTION

All profiles are unique - designed by TOPMET designers. All the designs are registered - legally protected throughout the European Union. TOPMET profiles, accessories and luminaires are manufactured in Poland.

PROJEKT / PRODUKCJA

Wszystkie profile są unikatowe - zaprojektowane przez projektantów TOPMET. Wszystkie wzory są zarejestrowane - chronione prawnie na terenie całej Unii Europejskiej. Profile, akcesoria i oprawy TOPMET wyprodukowane są w Polsce.

ENTWURF / FERTIGUNG

Alle Profile sind einzigartig - entwickelt von TOPMET Designern. Alle Modelle sind registriert worden - gesetzlich geschützt in ganz Europa. Die Profile, das Zubehör und die Leuchten von TOPMET sind in Polen hergestellt.

CONCEPTION / PRODUCTION

Tous les profilés sont uniques - conçus par les designers TOPMET. Tous les modèles sont enregistrés - protégés légalement dans toute l'Union européenne. Les profilés, accessoires et fixations TOPMET sont fabriqués en Pologne.



EU-registered industrial design
wzory przemysłowe EU
EU Industriedesign
Dessins et modèles industriels de l'UE



made in Poland
wyprodukowane w Polsce
in Polen hergestellt
Fabriqué en Pologne

WHAT DOES A PROFILE NAME INDICATE?
 CO OZNACZA NAZWA PROFILU?
 WAS SAGT UNS DER NAME DES PROFILS?
 QUE SIGNIFE LE NOM DU PROFILÉ ?

SURFACE10 BC/UX

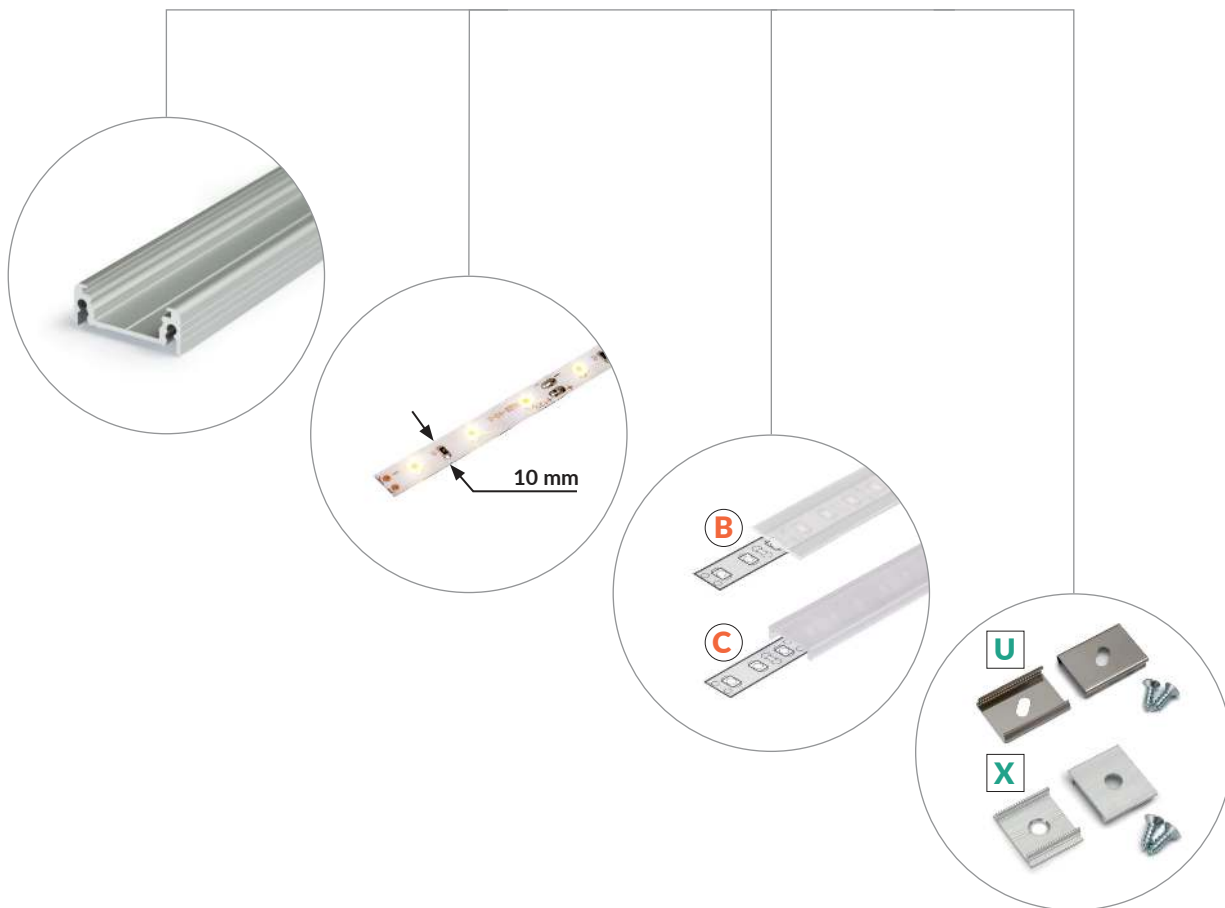

marking of diffusers fitting the sockets in the profile
 oznaczenia kloszy pasujących do gniazd w profilu
 die Bezeichnung der Abdeckungen, die mit den Befestigungssockeln in dem Profil passen
 désignation de diffuseurs selon leur type de montage

A A1 A9 B C C1 C2 C3 C4 C9 C10 D D9 E E7 E9 F G H I J K

marking of mountings fitting the profile
 oznaczenia mocowań pasujących do profilu
 Bezeichnungen der Halter, die zu dem Profil passen.
 désignation de fixations correspondant au profilé

Q Q9 S T U U1 U4 U5 U6 U7 U9 W X Y Z

MARKINGS OZNACZENIA BEZEICHNUNGEN DÉSIGNATIONS

PROFILE WITH SLICK SOCKET

We also have profiles with the Slick socket in our assortment. This feature allows to click in or slide in the diffuser.

SLIM8 AC2/Z → 32
 SMART10 AC2/Z → 34
 BEGTON12 J/S → 36
 SURFACE10.v2 BC/U → 42
 SURFACE14.v2 EE7F/Y → 46
 SMART16 BC3/U4 → 48
 LINEA20 EE7F/TY → 50
 WIDE24 G/W → 56
 VARIO30-01 ACDE-9/TY → 59
 VARIO30-02 ACDE-9/TY → 60
 VARIO30-03 ACDE-9/TY → 63
 COMBO30-01 ACDE-9 → 71
 SMART-IN10 AC2/Z → 88
 BEGTIN12 J/S → 90
 GROOVE10.v2 A1C/U → 94
 GROOVE14.v2 BC3/Y → 98
 SMART-IN16 BC3/U4 → 104
 LINEA-IN20 EE7F/U7 → 106
 VARIO30-06 ACDE-9/U9 → 111
 VARIO30-07 ACDE-9/U9 → 112
 QUARTER10 BD/U6 → 120
 CABI12 E → 122
 CABI12 DUO E → 124
 CORNER10.v2 A1C/U1 → 128

PROFIL Z GNIAZDEM SLICK

W naszym asortymencie posiadamy także profile z gniazdem Slick. Funkcja ta pozwala na łatwe „wklikiwanie” lub wsuwanie klosza.

PROFILE MIT DER SLICK FUNKTION

In unserem Sortiment haben wir auch LED Profile mit einem Slick Befestigungssockel. Diese Funktion ermöglicht ein einfaches Einclippen oder Einschieben der Abdeckung.

PROFILÉ AVEC LA FONCTION SLICK

Notre assortiment comprend également des profilés avec une solution Slick. Cette fonction vous permet de « cliquer » ou d'insérer facilement le diffuseur.

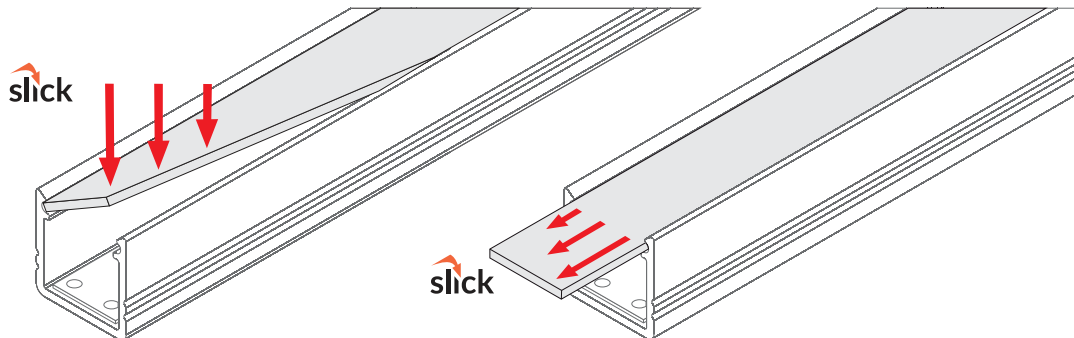

assembly
montaż
Montage
montage

removal
demontaż
Démontage
démontage

CORNER12.v2 EF/U → 132
 OMNI10 AC2 → 136
 GLOW12 UP A1C → 140
 GLOW12 DOWN A1C → 142
 LINEA-IN20 TRIMLESS EE7F → 150

VARIO30-04 ACDE-9 → 153
 VARIO30-05 ACDE-9 → 154
 UP-TILE10 A → 162
 UP-MINI10 A → 182
 SKIRT10 AC2/Q9 → 186

LED profile industry categories
kategorie branżowe profili LED
LED Profil Branchenkategorien
profilés LED dédiés à l'industrie



furniture
meblowe
Möbel-
mobilier



architectural
architektoniczne
architektonisch
architecture



lighting
oświetleniowe
Beleuchtungs-
éclairage

LED profile application categories
kategorie montażowe profili LED
Montagekategorien der LED Profile
catégories de profilé LED



surface
nawierzchniowy
Aufbauprofile
surface



suspended
zwieszany
hängend
suspendu



recessed
wpustowy
Einbauprofile
à encastrer



corner
kątowy
Eckprofile
d'angles



special application
specjalny
spezielle Profile
spécial



plaster-in
do szpachlowania
zum Spachteln
pour le remplissage



tile-in
do płytek
für Fliesen
pour les carreaux

others
inne
sonstige
autres



maximum LED strip width
maksymalna szerokość taśmy LED
maximale Breite des LED Streifens
largeur maximale de ruban LED



note
uwaga
Achtung
attention



assembly adhesive
klej montażowy
Montageklebstoff
colle de montage



sling
zawiesie
Abhängung
suspension



made in Poland
wyprodukowane w Polsce
in Polen hergestellt
fabriqué en Pologne



EU-registered industrial design
wzory przemysłowe EU
EU Industriemuster
dessins et modèles industriels de l'UE

HOW TO SELECT A DIFFUSER? JAK DOBRAĆ KLOSZ? WIE WÄHLT MAN DIE ABDECKUNG? COMMENT CHOISIR UN DIFFUSEUR ?

Diffusers for aluminium LED profiles differ in the level of transparency. Thanks to a conscious choice, you can plan the lighting effect, light dispersion and distribution better. A transparent diffuser absorbs a smaller amount of light, followed by frosted and opal ones.

Klosze do profili aluminiowych LED różnią się stopniem transparentności. Dzięki świadomemu wyborowi można lepiej zaplanować efekt świetlny, rozproszenie i rozsył światła. Klosz transparentny pochłania najmniejszą ilość światła, dalej szron i mleczny.

Die Abdeckungen für die LED Profile unterscheiden sich mit dem Grad der Lichtdurchlässigkeit. Eine bewusste Wahl ermöglicht besser den Lichteffect, die Lichtzerstreuung und Lichtverteilung einzuplanen. Die transparente Abdeckung nimmt am wenigsten Licht auf, danach ist die satinierte und opale Abdeckung.

Les diffuseurs pour les profilés en aluminium LED diffèrent par le degré de transparence. Grâce à un choix conscient, vous pouvez mieux planifier l'effet d'éclairage, la diffusion et la distribution de la lumière. Le diffuseur transparent absorbe la plus petite quantité de lumière, ensuite le diffuseur givré et opaque.

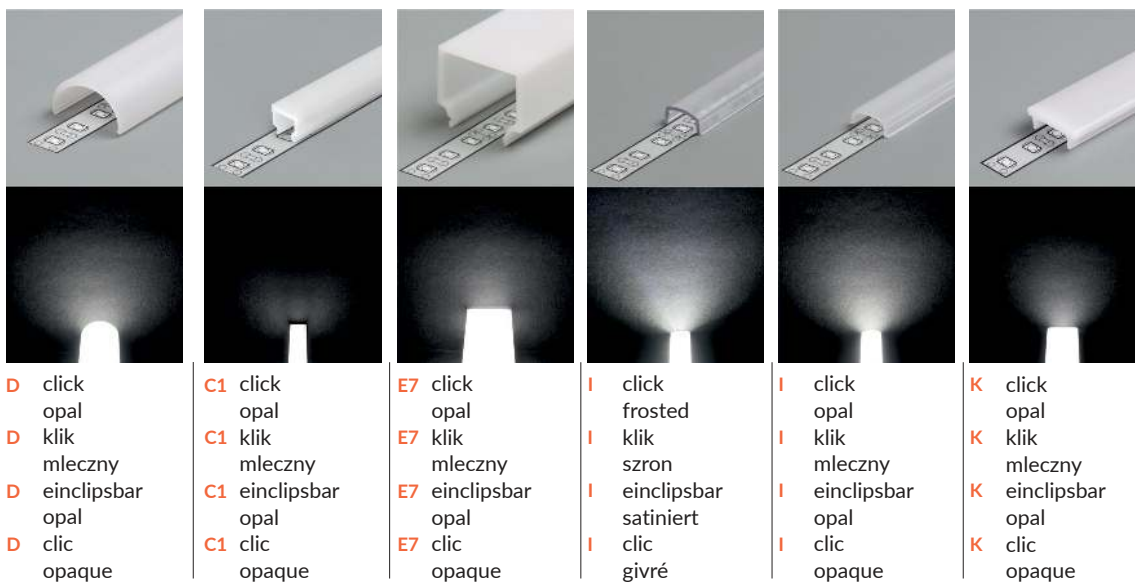
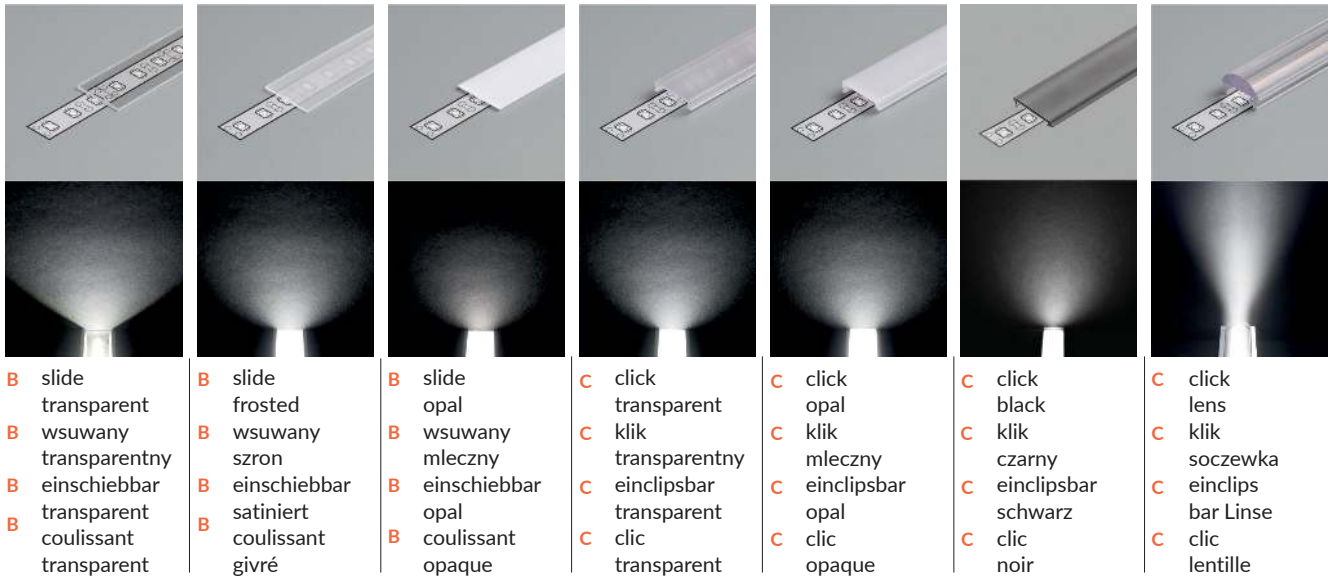

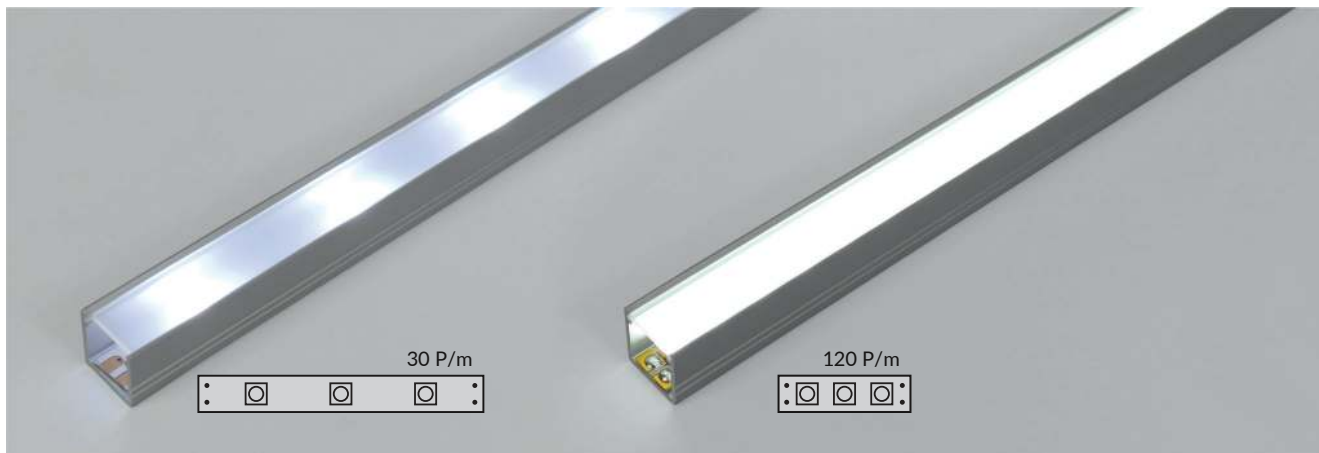

It also means a different degree of visibility of LED points. Opal diffuser in some profiles, in conjunction with a 120 P/m tape, allow to achieve the effect of a continuous line of light.

Oznacza to także różny stopień widoczności punktów LED. Klosze mleczne w niektórych profilach w połączeniu z taśmą 120 P/m pozwalają osiągnąć efekt ciągłej linii światła.

Das bedeutet auch verschiedene Stufe der Sichtbarkeit von LED Punkten. Wenn man in einigen Profilen opale Abdeckungen und ein LED Streifen mit 120 LEDs anwendet, gibt es den Effekt einer homogenen Lichtlinie.

Cela signifie également un degré différent de visibilité des points LED. Les diffuseurs opaques dans certains profilés en combinaison avec un ruban 120 P/m permettent d'obtenir l'effet d'une ligne continue de lumière.

THE DIFFUSERS ALSO DIFFER IN THE METHOD OF ASSEMBLY

SLIDE DIFFUSER
(labelling: A, A1, A9, B, E, G, H, J)
It is a strip of plastic available in 3 different degrees of transparency. It needs to be slid from the beginning of the profile and dragged along the marked socket or clicked in the Slick socket.

KLOSZE RÓŻNIĄ SIĘ TAKŻE SPOSOBEM MONTAŻU

KLOSZ WSUWANY
(oznaczenia: A, A1, A9, B, E, G, H, J)
Jest to pasek tworzywa dostępny w 3 różnych stopniach transparentności. Należy go wsunąć od początku profilu i przeciągnąć wzdłuż oznaczonego gniazda lub „wkliknąć” w gniazdo Slick.

ABDECKUNGEN UNTERSCHIEDEN SICH AUCH DURCH DIE ART UND WEISE DER MONTAGE.

ABDECKUNG ZUM EINSCHIEBEN
(Bezeichnung: A, A1, A9, B, E, G, H, J)
Das ist ein Streifen aus Kunststoff mit drei unterschiedlichen Graden der Lichtdurchlässigkeit. Man soll die Abdeckung vom Anfang des Profils einschieben und entlang des markierten Sockels ziehen oder in die Slick Befestigungssockel einclippen.

LES DIFFUSEURS DIFFÈRENT ÉGALEMENT PAR LA METHODE DE MONTAGE

DIFFUSEUR COULISSANT
(désignations: A, A1, A9, B, E, G, H, J)
Il s'agit de ruban en plastique disponible en 3 niveaux de transparence différents. Il doit être inséré depuis le début du profilé et tiré le long de la fente marquée ou « cliquer » dedans si le profilé a la fonction Slick.

CLICK DIFFUSER

(labelling: C, C1, C2, C3, C4, C9, C10, D, D9, E7, E9, F, I, K)
Its assembly and removal are more convenient. Access to the ends of the profile is not necessary, which allows to click in the diffuser even after installing the profile in a recess or a piece of furniture.

KLOSZ KLIK

(oznaczenia: C, C1, C2, C3, C4, C9, C10, D, D9, E7, E9, F, I, K)
Jego montaż i demontaż jest wygodniejszy. Dostęp do końców profilu nie jest konieczny, co pozwala wkliknąć klosz nawet po zamontowaniu profilu w wnęce lub w meblu.

ABDECKUNG ZU EINCLIPSEN

(Bezeichnung: C, C1, C2, C3, C4, C9, C10, D, D9, E7, E9, F, I, K)
Die Montage und Demontage der Abdeckung ist bequemer. Der Zugang zu den Enden des Profils ist nicht notwendig, was das Einclippen der Abdeckung sogar nach der Montage des Profils in einer Nische oder einem Möbelstück ermöglicht.

DIFFUSEUR CLIC

(désignations: C, C1, C2, C3, C4, C9, C10, D, D9, E7, E9, F, I, K)
Son montage et son démontage sont plus pratiques. L'accès aux extrémités du profilé n'est pas nécessaire, ce qui permet au diffuseur de s'enclipser même après le montage du profilé dans une niche ou dans un meuble.

HOW TO SELECT A DIFFUSER? JAK DOBRAĆ KLOSZ? WIE WÄHLT MAN DIE ABDECKUNG? COMMENT CHOISIR UN DIFFUSEUR ?



SYSTEM ACCESSORIES

Many of the diffusers in the TOPMET offer are system accessories.
It means that one diffuser fits a few, different profiles.

A letter describing the socket helps correct matching.
And so, e.g., the SURFACE10 BC/UX profile can be fitted with the diffusers:

- B slide
- C click
- C lens

Diffuser C click, on the other hands, fits the profiles:

UNI12 BCD/U → 38
SURFACE10 BC/UX → 40
SURFACE10.v2 BC/U → 42
GROOVE10 BC/UX → 92
GROOVE10.v2 A1C/U → 94
DEEP10 BC/UX → 102
CORNER10 BC/UX → 126
CORNER10.v2 A1C/U1 → 128
GLOW12 UP A1C → 140
GLOW12 DOWN A1C → 142
FRAME14 BC/Q → 144
SMOOTH12 BC/Q9 → 146
UNI-TILE12 C → 164
ARC12 CD/U5 → 170
PEN12 CJ → 174
WAY10 C → 178
WALLE12 BCD → 180

AKCESORIA SYSTEMOWE

W ofercie TOPMET wiele spośród kloszy to akcesoria systemowe.
Oznacza to, że ten sam klosz pasuje do kilku różnych profili.

W odpowiednim dopasowaniu pomaga litera opisująca gniazdo.
I tak np. do profilu LED SURFACE10 BC/UX pasują klosze:
- B wsuwany
- C klik
- C soczewka
Klosz C klik z kolei pasuje do profili:

KOMPATIBLES ZUBEHÖR

Viele von den Abdeckungen aus dem TOPMET Angebot gelten als kompatibles Zubehör.
Es bedeutet, dass die selbe Abdeckung mit mehreren Profilen zusammenpasst.

Bei dem richtigen Anpassen der Abdeckungen helfen die Buchstaben. Dementsprechend passen z. B. mit dem LED Profil SURFACE10 BC/UX folgende Abdeckungen zusammen:
- B zum Einschieben
- C zum Einclippen
- C Linse
Die Abdeckung C zum Einclippen passt wiederum mit folgenden Profilen zusammen:

ACCESSOIRES COMPATIBLES

De nombreux diffuseurs de l'offre TOPMET sont des accessoires compatibles. Cela signifie que le même diffuseur s'adapte à plusieurs profilés différents.

La lettre décrivant type de diffuseur aide à la bonne correspondance.
Ainsi, par exemple, le profilé LED SURFACE10 BC/UX convient aux diffuseurs :
- B coulissant
- C clic
- C lentille
Le diffuseur clic C, quant à lui, s'adapte aux profilés:

diffuser type rodzaj klosza Die Art der Abdeckung type de diffuseur	material materiał Das Material matériel	operating temperature temperatura stosowania Die Anwendungstemperatur température d'application		UV resistance odporność na UV UV- Beständigkeit résistance aux UV	fire hazard certificate* certyfikat na palność* Das Zertifikat für Brennbarkeit* certificat d'inflamma- -bilité*	transparency transparentność Lichtdurch- lässigkeit transparence
		min [°C]	max [°C]			
A, A1, A9, B, E, G, H, J transparent / transparentny transparent / transparent	PC	-30	100	✓	✓	95%
A, A1, A9, B, E, G, H, J frosted / szron / satiniert / givré	PP	-15	80	✓	✓	90%
A, A1, A9, B, E, G, H, J opal / mleczny / opal / opaque	PP	-15	80	✓	✓	60%
C, F transparent / transparentny transparent / transparent	PMMA	-20	70	✓	✓	95%
C, F opal / mleczny / opal / opaque	PMMA	-20	70	✓	✓	70%
C, F black / czarny / schwarz / noir	PMMA	-20	70	✓	✓	40%
C lens / soczewka / Linse / lentille	PMMA	-20	70	✓	✓	90%
C1, D9, E7, E9 opal / mleczny / opal / opaque	PMMA	-20	70	✓	✓	70%
C2 transparent / transparentny transparent / transparent	PMMA	-20	70	✓	✓	95%
C2 opal / mleczny / opal / opaque	PMMA	-20	70	✓	✓	70%
C2 black / czarny / schwarz / noir	PMMA	-20	70	✓	✓	40%
C3, C9 transparent / transparentny transparent / transparent	PMMA	-20	70	✓	✓	95%
C3, C9 opal / mleczny / opal / opaque	PMMA	-20	70	✓	✓	70%
C3, C9 black / czarny / schwarz / noir	PMMA	-20	70	✓	✓	40%
C4 opal / mleczny / opal / opaque	PC	-30	100	✓	✓	70%
C10 OPAL opal / mleczny / opal / opaque	PMMA	-20	70	✓	✓	75%
C10 NARROW black / czarny / schwarz / noir	PC	-30	100	✓	✓	90%
C10 WIDE opal / mleczny / opal / opaque	PC	-30	100	✓	✓	90%
D opal / mleczny / opal / opaque	PMMA	-20	70	✓	✓	60%
I frosted / szron / satiniert / givré	PC	-30	100	✓	✓	90%
I opal / mleczny / opal / opaque	PC	-30	100	✓	✓	80%
K opal / mleczny / opal / opaque	PC	-30	100	✓	✓	50%

END CAPS ZAŚLEPKI ENDKAPPEN EMBOUTS

The end caps, with the aim to aesthetically close the profile and additionally protect the LED source, come in four basic colours: silver, white, black and grey. Some of the end caps are available in opal colour for opal diffusers.

The material used for the production of the end caps meets the lighting non-combustibility standard no.: PN-EN 60695-2-11.
Material: ABS, PC, PMMA.

Zaślepki, mające na celu estetyczne domknięcie profilu oraz dodatkową ochronę źródła LED, występują w czterech podstawowych kolorach: srebrnym, białym, czarnym i szarym. Wybrane zaślepki dostępne są w wersji mlecznej do kloszy mlecznych.

Tworzywo użyte do produkcji zaślepek spełnia oświetleniową normę niepalności nr: PN-EN 60695-2-11.
Materiał: ABS, PC, PMMA.

Die Endkappen erfüllen die Funktion einer ästhetischen Beendigung des Profils und eines zusätzlichen Schutzes der LED Lichtquelle.

Die Endkappen sind in vier Grundfarben zugänglich: silbern, weiß, schwarz und grau. Gewählte Endkappen sind in der Version opal für opale Abdeckungen erreichbar. Der Kunststoff, der für die Produktion von den Endkappen verwendet wird, erfüllt die Feuerbeständigkeitsnorm zur Beleuchtung Nummer: PN-EN 60695-2-11. Das Material: ABS, PC, PMMA.

Les embouts, destinés à la fermeture esthétique du profilé et à la protection supplémentaire de la source LED, sont disponibles en quatre couleurs de base : argent, blanc, noir et gris. Pour certains modèles de diffuseurs opaques nous proposons les embouts opaques assortis. Le matériau utilisé pour la fabrication des embouts répond à la norme d'inflammabilité de l'éclairage N°: PN-EN 60695-2-11. Matériel : ABS, PC, PMMA.

white
biały
weiß
blanc



silver
srebrny
silbern
argent



black
czarny
schwarz
noir



grey
szary
grau
gris



opal
mleczny
opal
opaque



End caps with a hole or without it - which one to choose? Some of our end caps come in two versions:

Zaślepki z otworem czy bez - jakie wybrać? Część spośród naszych zaślepek występuje w dwóch wersjach:

Die Endkappen mit oder ohne Öffnung - welche wählt man? Viele von unseren Endkappen sind in zwei Versionen zugänglich:

Embouts avec ou sans trou - lequel choisir? Certains de nos embouts sont disponibles en deux versions :



With a hole: they allow aesthetic outlet for a cable without the need to drill through the end caps or the profile.

Z otworem: pozwalają na estetyczne wyprowadzenie przewodu bez konieczności przewiercania zaślepki lub profilu.

Mit der Öffnung: ermöglichen ein ästhetisches Durchführen des Kabels ohne in der Endkappe oder in dem Profil bohren zu müssen.

Avec un trou : ils permettent au câble d'être acheminé proprement sans percer à travers un embout ou un profilé.



Without a hole: they are an aesthetic and a tighter end caps of the profile. Recommended in cases where the appearance is particularly significant, or from the opposite side to the cable outlet.

Bez otworu: stanowią estetyczne i szczelniejsze zakończenie profilu. Zalecane tam, gdzie szczególnie istotny jest wygląd lub od strony przeciwnej niż wyprowadzenie przewodu.

Ohne Öffnung: bilden eine ästhetische und dichtere Beendigung des Profils. Empfohlen dort, wo das Aussehen besonders wichtig ist oder von der gegenüberliegenden Seite zur Kabeldurchführung.

Sans trou : ils fournissent une extrémité esthétique et plus serrée du profilé.

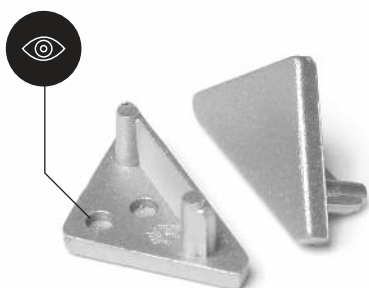

For many products, we offer end caps with points to drill a hole. Thanks to this, from one set of end caps, it is possible to obtain one end caps of each type: with a hole and without one.

Do wielu produktów oferujemy zaślepki z punktami do nawiercenia otworu. Dzięki temu z jednego kompletu zaślepek możliwe jest otrzymanie po jednej zaślepce: z otworem oraz bez otworu.

Für viele Profile bieten wir Endkappen mit Punkten für das Bohren einer Öffnung an. Mit dieser Lösung kann man aus einem Set von Endkappen jeweils eine Endkappe mit und ohne Öffnung haben.

Pour nombreux produits nous proposons les embouts avec un marquage derrière où on conseille de percer un trou. Grâce à cela il est possible d'obtenir un jeu d'embout complet : un avec trou et l'autre sans trou.

CONNECTORS X, T 180 DEG
ŁĄCZNIKI X, T 180 ST
VERBINDER X, T 180 GRAD
CONNECTEUR X, T 180 DEGRÉS

T² → 204

connector T 180 deg
 łącznik T 180 st
 Verbinder T 180 Grad
 connecteur T 180 degrés

SURFACE14 **EE7F/TY** → 44
 LINEA20 **EE7F/TY** → 50
 VARIO30-01 **ACDE-9/TY** → 59
 VARIO30-02 **ACDE-9/TY** → 60
 VARIO30-03 **ACDE-9/TY** → 63
 GROOVE14 **EE7F/TY** → 96
 DIAGONAL14 **F/TY** → 100
 CORNER14 **EE7F/TY** → 130



X² → 207

connector X 180 deg
 łącznik X 180 st
 Verbinder X 180 Grad
 connecteur X 180 degrés

SURFACE10 **BC/UX** → 40
 GROOVE10 **BC/UX** → 92
 DEEP10 **BC/UX** → 102
 FLAT8 **H/UX** → 114
 CORNER10 **BC/UX** → 126
 BACK10 **A/UX** → 176



T and X connector may be used to make extra long profiles by connecting multiple profiles.

Łącznik T oraz X może być użyty do stworzenia pojedynczego bardzo długiego profilu.

Verbinder T und X kann zur Fertigung eines sehr langen Profils benutzt werden.

Le connecteur T et le connecteur X peuvent être utilisés pour créer un seul profilé très long.

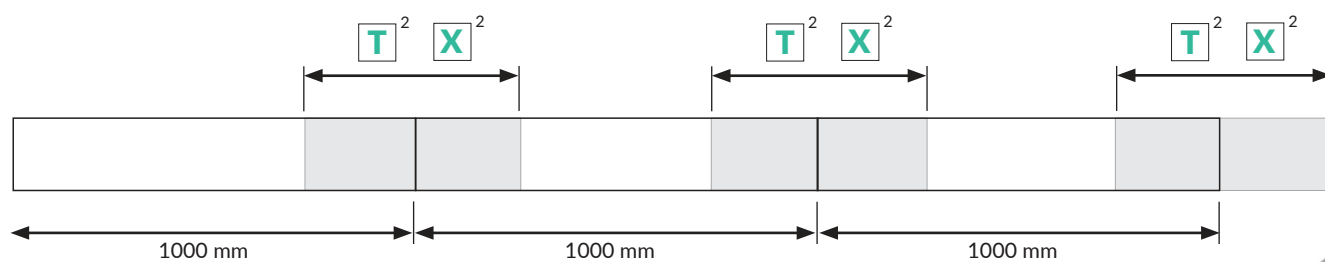

TOLERANCE TOLERANCJA TOLERANZ TOLÉRANCE

We make every effort to maintain maximum repeatability of our products. Despite this, there may be small differences between the individual batches due to the nature of the manufacturing processes. That is why we always recommend considering the following tolerances.

Dokładamy wszelkich starań, aby utrzymać maksymalną powtarzalność naszych produktów. Mimo to pomiędzy poszczególnymi partiami występować mogą drobne różnice wynikające ze specyfiki procesów wytwarzania. Dlatego zawsze zalecamy wzięcie pod uwagę poniższych tolerancji.

Wir sind darum sehr bemüht, dass eine maximale Wiederholbarkeit unserer Produkte eingehalten wird. Trotzdem können zwischen den jeweiligen Partien geringfügige Unterschiede vorkommen, die auf die Spezifik des Herstellungsverfahrens zurückzuführen sind. Deswegen empfehlen wir immer die vorliegenden Toleranzen zu berücksichtigen.

Nous mettons tout en oeuvre pour maintenir la répétabilité maximale de nos produits. Néanmoins, il peut y avoir de légères différences entre les lots individuels en raison de la spécificité des procédés de fabrication. Par conséquent, nous vous recommandons toujours de prendre en compte les tolérances suivantes.

LENGTH

Standard tolerance*

PROFILES (except listed below) 63720000, 63720001, 63720002, 766900	+3 mm
CLICK DIFFUSERS: 1000 mm, 2000 mm, 3000 mm (except listed below)	+5 mm
CLICK DIFFUSERS: 2000 mm - C9, D9, E7, E9	+20 mm
CLICK DIFFUSERS: 4000 mm	+150 mm
SLIDE DIFFUSERS	+20 mm

*It is possible to prepare product with a narrowed, special tolerance. Please ask your key account manager for details. Cutting of the products is carried out at a temperature of 20°C.

DŁUGOŚĆ

Standardowa tolerancja*

PROFILE (poza wymienionymi poniżej) 63720000, 63720001, 63720002, 76690001	+3 mm
KLOSZE KLIK: 1000 mm, 2000 mm, 3000 mm (poza wymienionymi poniżej)	+5 mm
KLOSZE KLIK: 2000 mm - C9, D9, E7, E9	+20 mm
KLOSZE KLIK: 4000 mm	+150 mm
KLOSZE WSUWANE	+20 mm

*Istnieje możliwość przygotowania produktu w zawężonej tolerancji specjalnej. O szczegóły zapytaj opiekuna handlowego. Cięcie produktów wykonywane jest w temperaturze 20°C.

LÄNGE

Standardmäßige Toleranz*

PROFILE (außer der unten erwähnten) 63720000, 63720001, 63720002, 76690001	+3 mm
ABDECKUNG ZUM EINCLIPSEN: 1000 mm, 2000 mm, 3000 mm (außer der unten erwähnten)	+5 mm
ABDECKUNG ZUM EINCLIPSEN: 2000 mm - C9, D9, E7, E9	+20 mm
ABDECKUNG ZUM EINCLIPSEN: 4000 mm	+150 mm
ABDECKUNG ZUM EINSCHIEBEN	+20 mm

*Es gibt die Möglichkeit der Produktvorbereitung in der eingeeengten Spezialtoleranz. Nach den Details fragen Sie bitte Ihren Handelsbetreuer. Produkte werden bei der Temperatur von 20°C geschnitten.

LONGUEUR

Tolérance standard*

PROFILÉS (sauf pour ce qui suit) 63720000, 63720001, 63720002, 76690001	+3 mm
DIFFUSEURS À CLIPSER : 1000 mm, 2000 mm, 3000 mm (sauf pour ce qui suit)	+5 mm
DIFFUSEURS À CLIPSER : 2000 mm - C9, D9, E7, E9	+20 mm
DIFFUSEURS À CLIPSER : 4000 mm	+150 mm
DIFFUSEURS COULISSANTS	+20 mm

*Attention. La préparation du produit avec une tolérance autre que la tolérance standard augmente les coûts, allonge le délai de livraison et nécessite que la tolérance souhaitée soit spécifiée lors de la commande. Les produits sont coupés à une température de 20°C.

DIMENSIONS OF CROSS SECTION

For all provided profile dimensions we apply tolerances in accordance with PN-EN 755-9.

DURCHMESSER

Alle angegebenen Profile unterliegen der Toleranz gemäß der Norm PN-EN 755-9.

WYMIARY PRZEKROJÓW

Do wszystkich podawanych wymiarów profili stosowana jest tolerancja zgodnie z Normą PN-EN 755-9.

DIMENSIONS DE LA SECTION

La tolérance selon la norme PN-EN 755-9 est appliquée à toutes les dimensions données des profilés.

COLOUR	
ANODIZED SURFACES	silver
	black
PAINTED SURFACES (according to the RAL palette)	white: RAL 9003 mat
	black: RAL 9005 mat

ATTENTION! Aluminium profiles and accessories may contain surfaces that are not visible after assembly, on which there may be acceptable process marks and for which a surface quality assessment is not applicable.

FARBE	
ELOXIERTE OBERFLÄCHEN	silbern
	schwarz
LACKIERTE OBERFLÄCHEN (anhand der RAL Palette)	weiß: RAL 9003 matt
	schwarz: RAL 9005 matt

ACHTUNG! Auf den Aluminiumprofilen und dem Zubehör können Flächen auftreten, die nach der Montage unsichtbar sind und zulässige technologische Spuren aufweisen, für welche die Bewertung der Flächenqualität nicht anzuwenden ist.

KOLOR	
POWIERZCHNIE ANODOWANE	srebrny
	czarny
POWIERZCHNIE MALOWANE (na podstawie palety RAL)	biały: RAL 9003 mat
	czarny: RAL 9005 mat

UWAGA! Profile aluminiowe i akcesoria mogą zawierać powierzchnie niewidoczne po montażu, na których mogą występować dopuszczalne ślady technologiczne i dla których ocena jakości powierzchni nie ma zastosowania.

COULEUR	
SURFACES ANODISÉES	argent
	noir
SURFACES PEINTES (basé sur la palette RAL)	blanc: RAL 9003 mat
	noir: RAL 9005 mat

ATTENTION ! Certaines surfaces de profilés en aluminium et d'accessoires peuvent être invisibles et contenir des traces de fabrication acceptables auxquelles l'évaluation de la qualité de surface ne s'applique pas.

AVAILABLE LENGTHS

Aluminium profiles:

1000 mm, 2000 mm, 3000 mm, 4050 mm

Click diffusers:

1000 mm, 2000 mm, 3000 mm, 4000 / 4050 / 4100 mm

Slide diffusers, opal and transparent:

1000 mm, 2000 mm

Slide diffusers, frosted:

1000 mm, 2000 mm, 3000 mm

C, C2, F diffusers:

reel 20 000 mm (20 m)

VERFÜGBARE LÄNGEN

Aluprofil:

1000 mm, 2000 mm, 3000 mm, 4050 mm

Abdeckungen einclipbar:

1000 mm, 2000 mm, 3000 mm, 4000 / 4050 / 4100 mm

Abdeckungen einschiebbar, opal und transparent:

1000 mm, 2000 mm

Abdeckungen einschiebbar, satiniert:

1000 mm, 2000 mm, 3000 mm

C, C2, F Abdeckungen:

Rolle 20 000 mm (20 m)

DOSTĘPNE DŁUGOŚCI

Profile aluminiowe:

1000 mm, 2000 mm, 3000 mm, 4050 mm

Klosze klik:

1000 mm, 2000 mm, 3000 mm, 4000 / 4050 / 4100 mm

klosze wsuwane mleczne i transparentne:

1000 mm, 2000 mm

Klosze wsuwane szron:

1000 mm, 2000 mm, 3000 mm

klosze C, C2, F:

rolki 20 000 mm (20 m)

LONGUEURS DISPONIBLES

Profilés en aluminium :

1000 mm, 2000 mm, 3000 mm, 4050 mm

Diffuseurs à clipser :

1000 mm, 2000 mm, 3000 mm, 4000 / 4050 / 4100 mm

Diffuseurs coulissants opaque et transparent :

1000 mm, 2000 mm

Diffuseurs coulissants givré :

1000 mm, 2000 mm, 3000 mm

Diffuseurs C, C2, F:

rouleau 20 000 mm (20 m)

WARRANTY

Standard TOPMET products warranty = 12 months.

GARANTIE

Standardgarantie für TOPMET-Produkte = 12 Monate.

GWARANCJA

Standardowa gwarancja na produkty TOPMET = 12 miesięcy.

GARANTIE

Garantie standard pour les produits TOPMET = 12 mois.

PAINTING SERVICE USŁUGA MALOWANIA DIENSTLEISTUNG DES ANSTREICHENS SERVICE DE PEINTURE

From now, you can order selected TOPMET Light products in one of the 2530 RAL colours.

The RAL chart features also metallic colours, including gold.

Ask your Account Manager about the minimum purchase and technical details.

Od teraz wybrane produkty topmet zamówisz w jednym z 2530 kolorów palety RAL.

Paleta RAL zawiera również kolory metaliczne - w tym złoty.

O minima zakupowe i szczegóły techniczne - zapytaj swojego Opiekuna Klienta.

Ab jetzt gewählte TOPMET Produkte bestellen Sie in beliebiger Farbe aus 2530 Farben der RAL Palette.

RAL Palette beinhaltet auch metallische Farben - darunter golden.

Nach MOQ und den technischen Details fragen Sie Ihren Kundenbetreuer.

Désormais certains produits haut de gamme, vous pouvez commander dans n'importe quelle couleur à partir de 2530 couleurs de la palette RAL.

La palette RAL comprend également des couleurs métalliques - y compris l'or. Pour connaître MOQ exigée ou des détails techniques - merci de contacter notre Service Client.



Profile & end cap in the same colour
Ten sam kolor profilu i zaślepki
Gleiche Farbe des Profils und der Endkappe
Même profilé et même couleur de embout



Quality and repeatability
Jakość i powtarzalność barwy
Farbqualität und Wiederholbarkeit
Qualité et répétabilité des couleurs

Metalic paint
including golden

Kolory metaliczne
w tym złoty

Metallische Farben
einschließlich Gold

Couleurs métalliques,
y compris l'or



ECOLOGY EKOLOGIA ÖKOLOGIE ÉCOLOGIE

What we should pay particular attention to is the impact of everyday use devices on the natural environment. And so, lights using the LED technology are biodegradable, have a longer lifespan compared to traditional sources and consume less energy. Moreover, LED does not contain mercury.

less source replacements = less waste reaching the environment

To, na co powinniśmy zwrócić największą uwagę, to oddziaływanie na środowisko naturalne urządzeń codziennego użytku. I tak światła wykorzystujące technologię LED są biodegradowalne, mają większą żywotność w stosunku do tradycyjnych źródeł oraz zużywają mniej energii. Ponadto LED nie zawiera rtęci.

mniej wymian źródeł = mniej odpadów trafiających do środowiska

Das, worauf wir besonders unsere Aufmerksamkeit lenken sollen, ist die Auswirkung der Alltagsgeräte auf unsere natürliche Umwelt. Die Leuchten mit LED Technologie sind biologisch abbaubar, haben eine längere Lebensdauer im Vergleich zu traditionellen Lichtquellen und verbrauchen weniger Energie. Übrigens beinhalten LEDs kein Quecksilber.

Weniger Austausch von Lichtquellen = weniger Abfall in unserer Umwelt

Ce à quoi nous devons prêter le plus d'attention, c'est l'impact environnemental des appareils de tous les jours. Ainsi, les lampes utilisant la technologie LED sont biodégradables, ont une durée de vie plus longue que les sources traditionnelles et consomment moins d'énergie. De plus, la LED ne contient pas de mercure.

moins d'échanges de sources = moins de déchets destinés à l'environnement

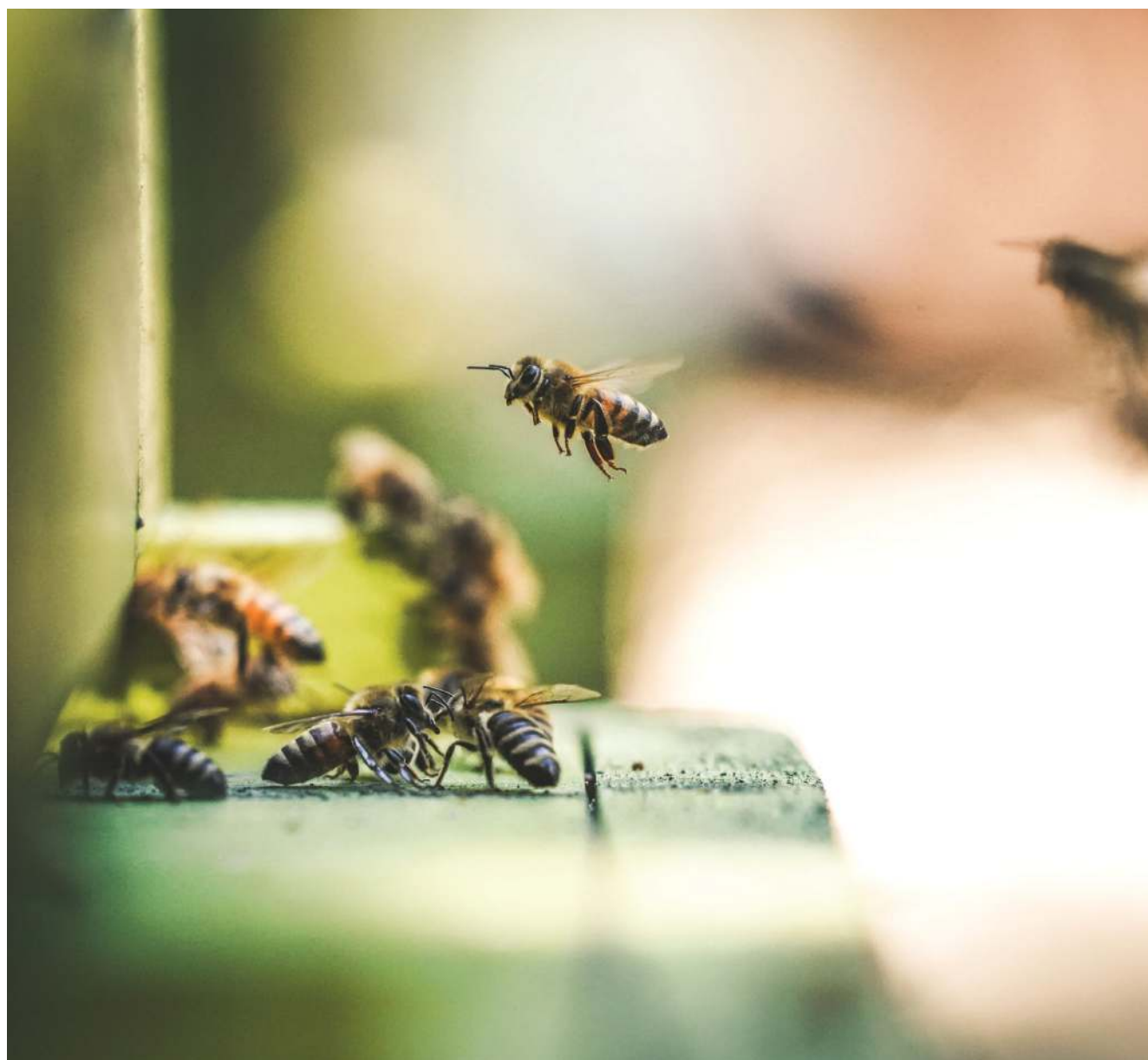







**SURFACE, SUSPENDED
NAWIERZCHNIOWE, ZWIESZANE
AUFBAUPROFILLE, AUSGESETZT
SURFACE, SUSPENSION**



max 8 mm

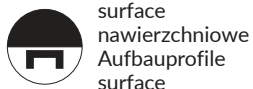

surface
nawierzchniowe
Aufbauprofile
surface



furniture
meblowe
Möbel-
mobilier

- universal application
- Slick socket
- 2 channels for mounting plates (with or without wall distance)
- painted mounting plates

- uniwersalne zastosowanie
- gniazdo Slick
- 2 rowki - 2 poziomy przymocowania uchwytu (z dystansem od ściany lub bez)
- malowane uchwyty

- universelle Anwendung
- Sockel mit Slick Funktion
- zwei Rillen - zwei Niveaus der Befestigung des Halters (mit einem Abstand oder ohne Abstand von der Wand)
- gemalte Halter

- usage universel
- prise Slick
- 2 rainures - 2 niveaux de montage de la fixation (avec ou sans distance du mur)



more
information



więcej
szczegółów

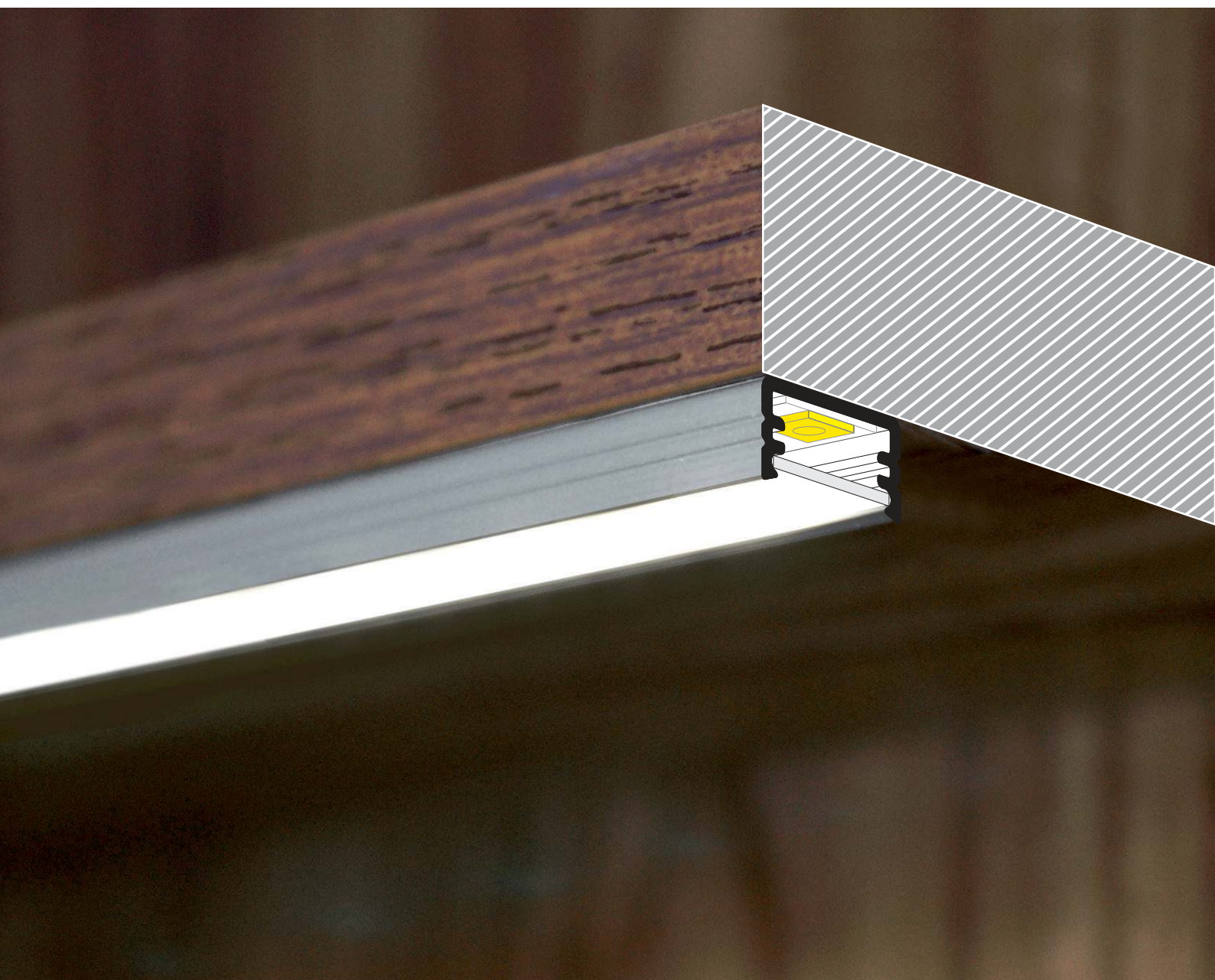

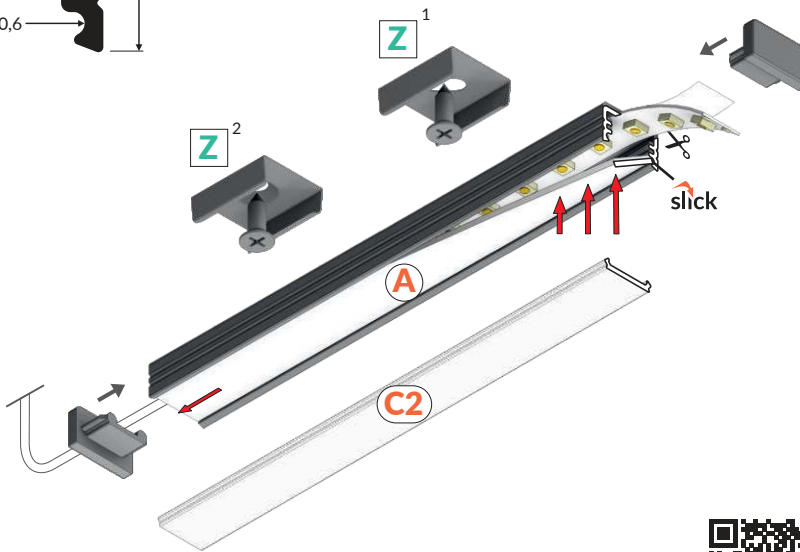
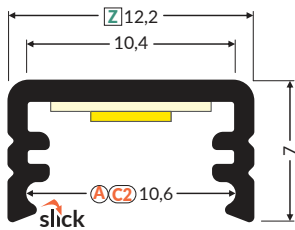

Technical manual
Instrukcja techniczna
Technische Anleitung
Manuel technique



Z¹ → 208

mounting plate Z
uchwyt Z
Halter Z
fixation Z

Z² → 208

mounting plate Z cone
uchwyt Z cone
Halter Z cone
fixation Z cône

A → 194

diffuser A slide
klosz A wsuwany
Abdeckung A einschiebbar
diffuseur A coulissant

C2 → 196

diffuser C2 click
klosz C2 klik
Abdeckung C2 einclipsbar
diffuseur C2 clic

white painted biały malowany weiß lackiert peint en blanc	anodized anodowany eloxiert surface anodisée	black anodized czarny anodowany schwarz eloxiert noir anodisé	raw aluminium surowe aluminium Rohaluminium aluminium brut
1000 mm 89020001	89020020	89020021	89020000
2000 mm 89030001	89030020	89030021	89030000
3000 mm 89190001	89190020	89190021	89190000
4050 mm 89200001	89200020	89200021	89200000

end cap SLIM8
zaślepka SLIM8
Endkappe SLIM8
embout SLIM8



white biały weiß blanc	silver srebrny silbern argent
89080001	89080040

black czarny schwarz noir	grey szary grau gris
89080002	89080022

end cap SLIM8 with hole
zaślepka SLIM8 z otworem
Endkappe SLIM8 mit Öffnung
embout SLIM8 avec un trou



white biały weiß blanc	silver srebrny silbern argent
89140001	89140040

black czarny schwarz noir	grey szary grau gris
89140002	89140022

connector SLIM8 90 deg
łącznik SLIM8 90 st
Verbinder SLIM8 90 Grad
connecteur SLIM8 90 degrés

material: aluminium
materiał: aluminium
Material: Aluminium
matériel: aluminium

white painted
biały malowany
weiß lackiert
peint en blanc
89150001

anodized
anodowany
eloxiert
surface anodisée
89150020

black anodized
czarny anodowany
schwarz eloxiert
noir anodisé
89150021

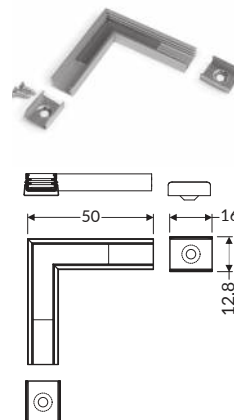

holder SLIM8 simple
uchwyt SLIM8 prosty
Halter SLIM8 einfach
fixation SLIM8 simple

material: zinc coated steel
materiał: stal ocynkowana
Material: Verzinkter Stahl
matériel: acier galvanisé

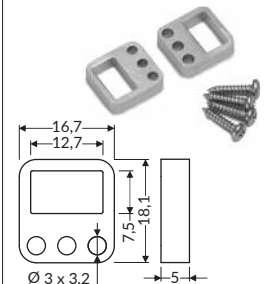

zinc coated steel
stal ocynkowana
verzinkter Stahl
acier galvanisé
89110030



max 10 mm



surface
nawierzchniowe
Aufbauprofile
surface



furniture
meblowe
Möbel-
mobilier

- continuous line of light (when using LED strip 120 P/m and opal diffuser)
- Slick socket
- miniature dimensions
- universal application
- the possibility of using waterproof LED strips

- ciągła linia światła (przy zastosowaniu taśmy 120 P/m i klosza mlecznego)
- gniazdo Slick
- miniaturowe gabaryty
- uniwersalne zastosowanie
- możliwość zastosowania taśm wodoodpornych

- eine homogene Lichtlinie (unter Verwendung von LED Streifen mit 120 leds/m und einer opalen Abdeckung)
- Sockel mit Slick Funktion
- kleine Maße
- universelle Anwendung
- Möglichkeit der Anwendung von wasserdichten Streifen

- une ligne continue de lumière (en utilisant un ruban 120 P/m et un diffuseur opaque)
- prise avec fonction Slick- dimensions miniatures
- usage universel
- possibilité d'utilisation du ruban LED étanche



more
information



więcej
szczegółów



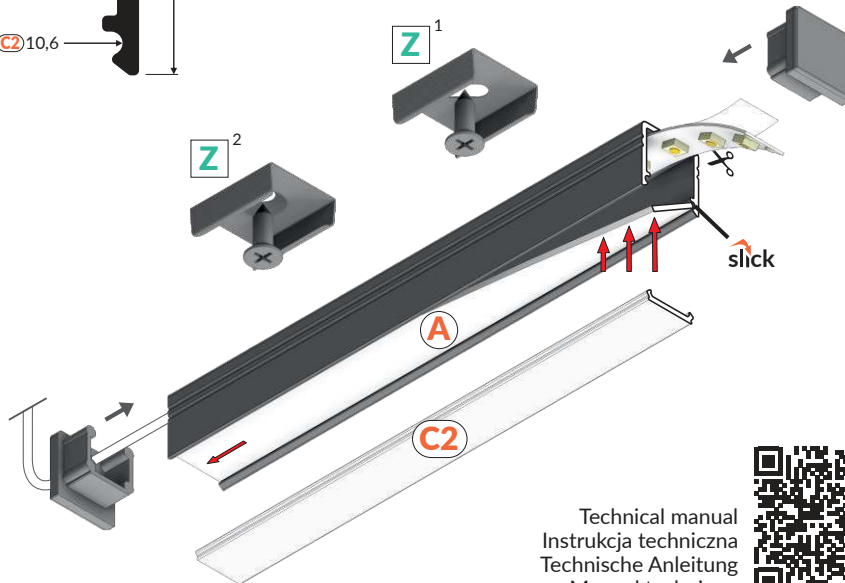
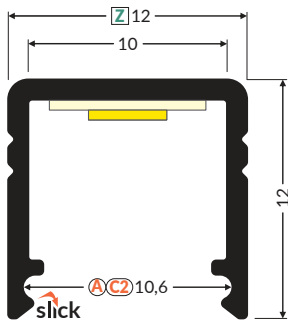

Technical manual
Instrukcja techniczna
Technische Anleitung
Manuel technique



Z¹ → 208

mounting plate Z
uchwyt Z
Halter Z
fixation Z

Z² → 208

mounting plate Z cone
uchwyt Z cone
Halter Z cone
fixation Z cône

A → 194

diffuser A slide
klosz A wsuwany
Abdeckung A einschiebbar
diffuseur A coulissant

C2 → 196

diffuser C2 click
klosz C2 klik
Abdeckung C2 einclipsbar
diffuseur C2 clic

white painted biały malowany weiß lackiert peint en blanc	anodized anodowany eloxiert surface anodisée	black anodized czarny anodowany schwarz eloxiert noir anodisé	raw aluminium surowe aluminium Rohaluminium aluminium brut
1000 mm C2010001	C2010020	C2010021	C2010000
2000 mm C2020001	C2020020	C2020021	C2020000
3000 mm C2030001	C2030020	C2030021	C2030000
4050 mm C2040001	C2040020	C2040021	C2040000

end cap SMART10
zaślepka SMART10
Endkappe SMART10
embout SMART10



white biały weiß blanc	silver srebrny silbern argent
C2940001	C2940040

black czarny schwarz noir	grey szary grau gris
C2940002	C2940022

end cap SMART10 with hole
zaślepka SMART10 z otworem
Endkappe SMART10 mit Öffnung
embout SMART10 avec un trou



white biały weiß blanc	silver srebrny silbern argent
C2960001	C2960040

black czarny schwarz noir	grey szary grau gris
C2960002	C2960022

connector SMART10 90 deg
łącznik SMART10 90 st
Verbinder SMART10 90 Grad
connecteur SMART10 90 degrés

material: aluminium
materiał: aluminium
Material: Aluminium
matériel: aluminium

white painted
biały malowany
weiß lackiert
peint en blanc
C2910001

anodized
anodowany
eloxiert
surface anodisée
C2910020

black anodized
czarny anodowany
schwarz eloxiert
noir anodisé
C2910021

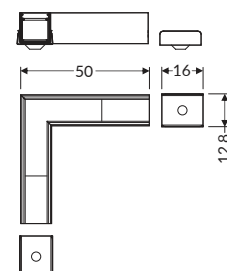

BEGTON12 J/S



max 12 mm



surface
nawierzchniowe
Aufbauprofile
surface



furniture
meblowe
Möbel-
mobilier

- light weight, budget profile
- Slick socket

- lekki profil budżetowy
- gniazdo z funkcją Slick

- ein leichtes Budget-Profil
- Sockel mit Slick Funktion

- profilé léger à prix bas
- prise avec fonction Slick



more
information



więcej
szczegółów



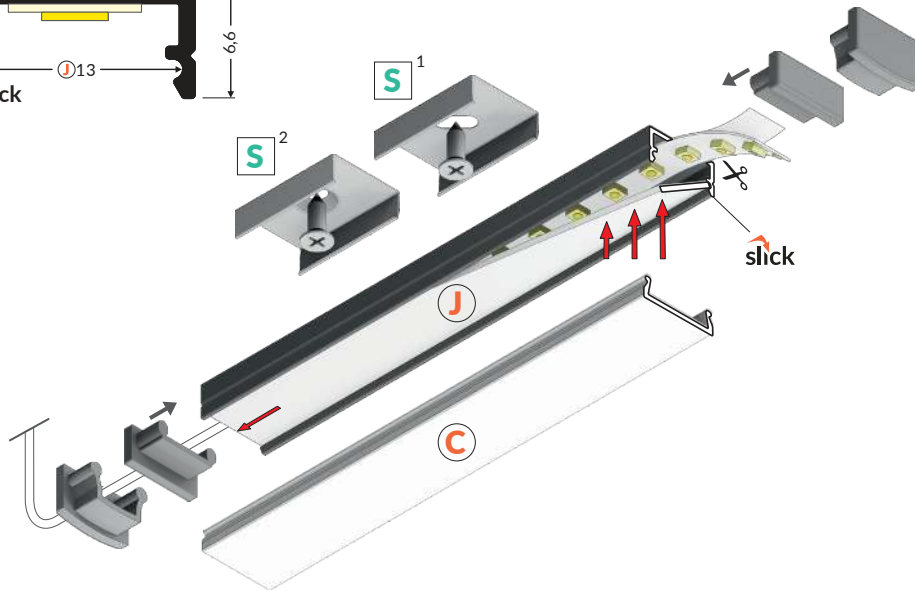
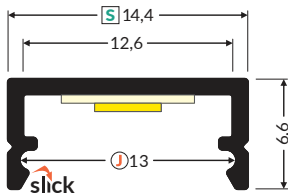

Technical manual
Instrukcja techniczna
Technische Anleitung
Manuel technique

S¹ → 204

mounting plate S
uchwyt S
Halter S
fixation S

S² → 204

mounting plate S cone
uchwyt S cone
Halter S cone
fixation S cône

J → 200

diffuser J slide
klosz J wsuwany
Abdeckung J einschiebbar
diffuseur J coulissant

C → 195

diffuser C click
klosz C klik
Abdeckung C einclipsbar
diffuseur C clic



white painted
biały malowany
weiß lackiert
peint en blanc



anodized
anodowany
eloxiert
surface anodisée



black anodized
czarny anodowany
schwarz eloxiert
noir anodisé



raw aluminium
surowe aluminium
Rohaluminium
aluminium brut

1000 mm	C7010001	C7010020	C7010021	C7010000
2000 mm	C7020001	C7020020	C7020021	C7020000
3000 mm	C7030001	C7030020	C7030021	C7030000
4050 mm	C7040001	C7040020	C7040021	C7040000

end cap BEGTON12
zaślepka BEGTON12
Endkappe BEGTON12
embout BEGTON12



white
biały
weiß
blanc

C7960001

silver
srebrny
silbern
argent

C7960040

black
czarny
schwarz
noir

C7960002

grey
szary
grau
gris

C7960022

end cap BEGTON12 C
zaślepka BEGTON12 C
Endkappe BEGTON12 C
embout BEGTON12 C



white
biały
weiß
blanc

C7940001

silver
srebrny
silbern
argent

C7940040

black
czarny
schwarz
noir

C7940002

grey
szary
grau
gris

C7940022

UNI12 BCD/U



max 12 mm



surface
nawierzchniowe
Aufbauprofile
surface



furniture
meblowe
Möbel-
mobilier

- 8 diffusers to choose from
- increased radiation -
it is possible to use
a stronger LED strip

- 8 kloszy do wyboru
- zwiększona radiacja -
możliwość zastosowania
mocniejszej taśmy LED

- 8 Abdeckungen zur Wahl
- erhöhte Radiation -
die Möglichkeit der
Anwendung eines stärkeren
LED Streifens

- 8 diffuseurs au choix
- dissipation thermique accrue -
possibilité d'utiliser un ruban LED
plus puissant



more
information



więcej
szczegółów

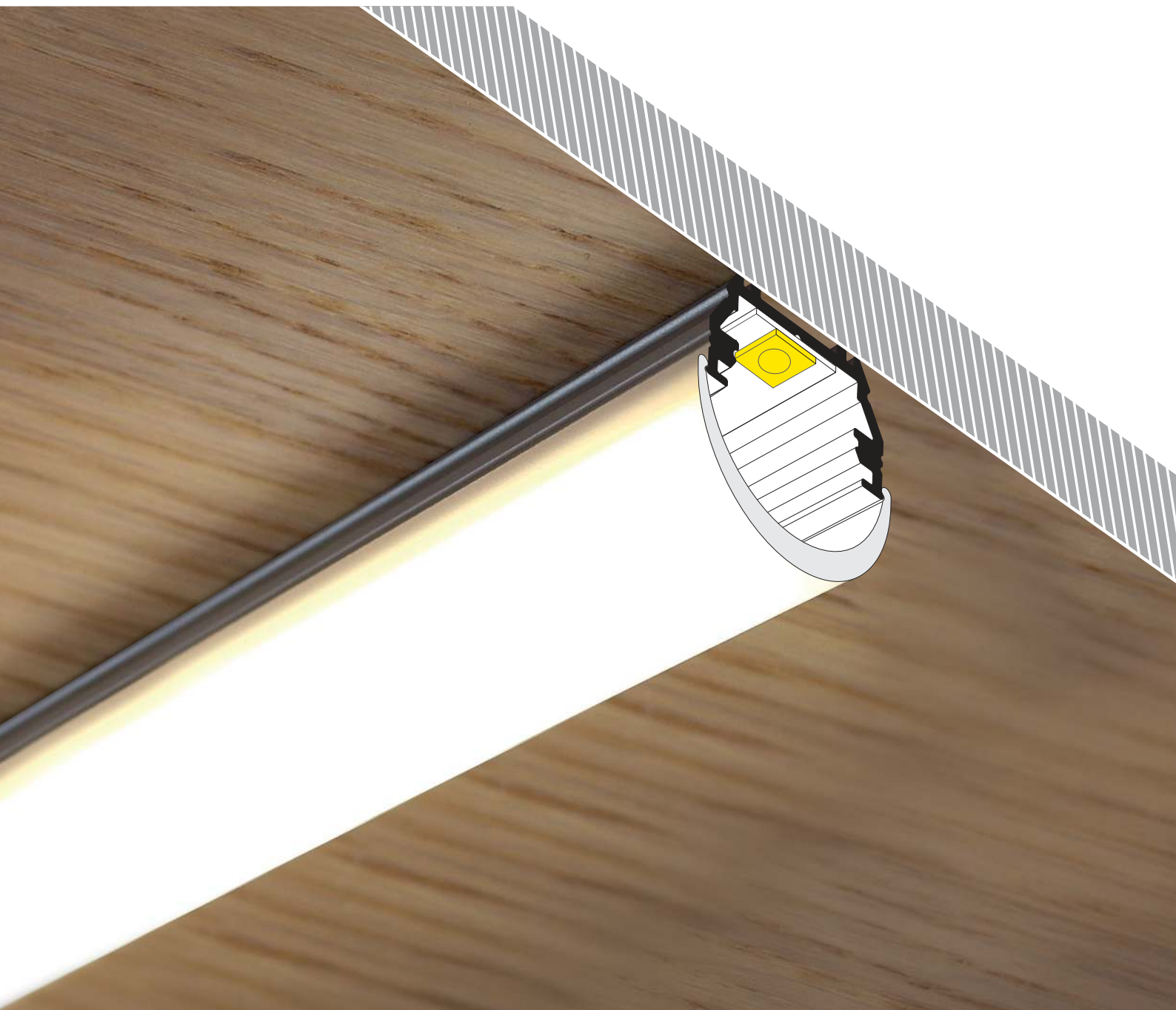

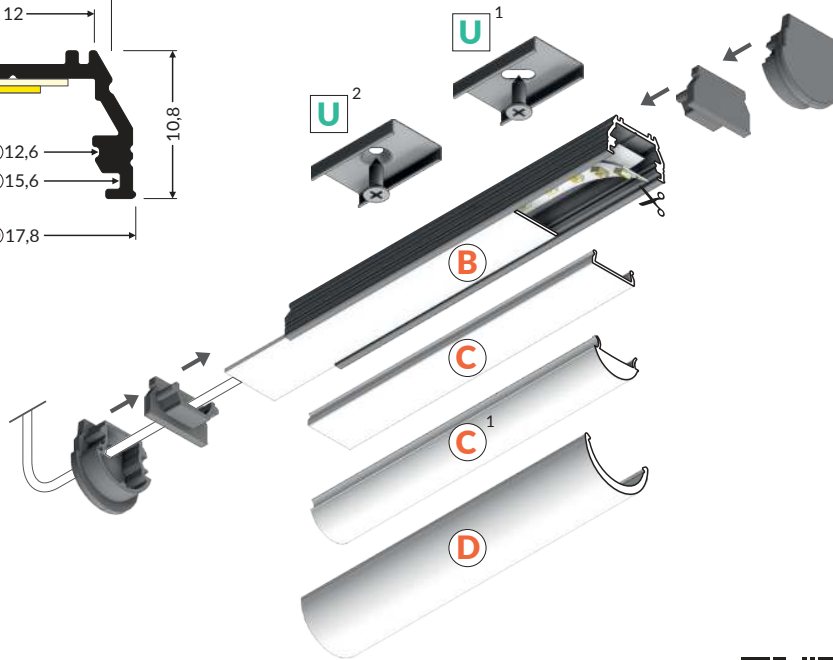
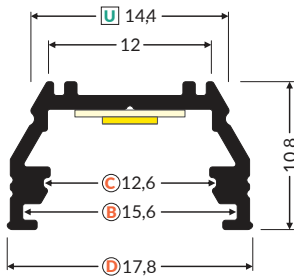

Technical manual
Instrukcja techniczna
Technische Anleitung
Manuel technique



U¹ → 204

mounting plate U
uchwyt U
Halter U
fixation U

U² → 204

mounting plate U cone
uchwyt U cone
Halter U cone
fixation U cône

B → 194

diffuser B slide
klosz B wsuwany
Abdeckung B einschiebbar
diffuseur B coulissant

C → 195

diffuser C click
klosz C klik
Abdeckung C einclipsbar
diffuseur C clic

C¹ → 195

diffuser C click lens gen2
klosz C klik soczewka gen2
Abdeckung C einclipsbar
Linse gen2
diffuseur C clic lentille gen 2

D → 198

diffuser D click
klosz D klik
Abdeckung D einclipsbar
diffuseur D clic



white painted
biały malowany
weiß lackiert
peint en blanc



anodized
anodowany
eloxiert
surface anodisée



black anodized
czarny anodowany
schwarz eloxiert
noir anodisé



raw aluminium
surowe aluminium
Rohaluminium
aluminium brut

1000 mm	A1010001	A1010020	A1010021	A1010000
2000 mm	A1020001	A1020020	A1020021	A1020000
3000 mm	A1170001	A1170020	A1170021	A1170000
4050 mm	A1110001	A1110020	A1110021	A1110000

connector UNI12 90 deg
łącznik UNI12 90 st
Verbinder UNI12 90 Grad
connecteur UNI12 90 degrés

material: aluminium
material: aluminium
Material: Aluminium
matériel: aluminium



end cap UNI12 gen2
zaślepka UNI12 gen2
Endkappe UNI12 gen2
embout UNI12 gen2



white
biały
weiß
blanc
A1900001

silver
srebrny
silbern
argent
A1900040

end cap UNI12 gen2
with hole
zaślepka UNI12 gen2
z otworem
Endkappe UNI12 gen2
mit Öffnung
embout UNI12 gen2
avec un trou



white
biały
weiß
blanc
A1890001

silver
srebrny
silbern
argent
A1890040

end cap UNI12 D
zaślepka UNI12 D
Endkappe UNI12 D
embout UNI12 D



white
biały
weiß
blanc
A1940001

silver
srebrny
silbern
argent
A1940040

end cap UNI12 D
with hole
zaślepka UNI12 D
z otworem
Endkappe UNI12 D
mit Öffnung
embout UNI12 D
avec un trou



white
biały
weiß
blanc
A1960001

silver
srebrny
silbern
argent
A1960040

white painted
biały malowany
weiß lackiert
peint en blanc
A1910001

anodized
anodowany
eloxiert
surface anodisée
A1910020

black anodized
czarny anodowany
schwarz eloxiert
noir anodisé
A1910021

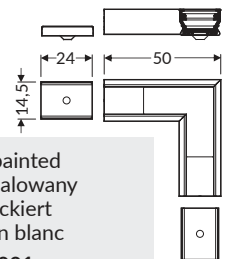

black
czarny
schwarz
noir
A1900002

grey
szary
grau
gris
A1900022

black
czarny
schwarz
noir
A1890002

grey
szary
grau
gris
A1890022

black
czarny
schwarz
noir
A1940002

grey
szary
grau
gris
A1940022

black
czarny
schwarz
noir
A1960002

grey
szary
grau
gris
A1960022

SURFACE10 BC/UX



max 10 mm



surface
nawierzchniowe
Aufbauprofile
surface



furniture
meblowe
Möbel-
mobilier

- hidden mounting
- wide range of accessories,
7 types of diffusers

- ukryte mocowanie
- szeroka oferta akcesoriów,
7 typów kloszy

- eine versteckte Befestigung
- eine breite Zubehörwahl,
7 Arten der Abdeckungen

- fixation cachée
- large gamme d'accessoires,
7 types des diffuseurs



more
information



więcej
szczegółów

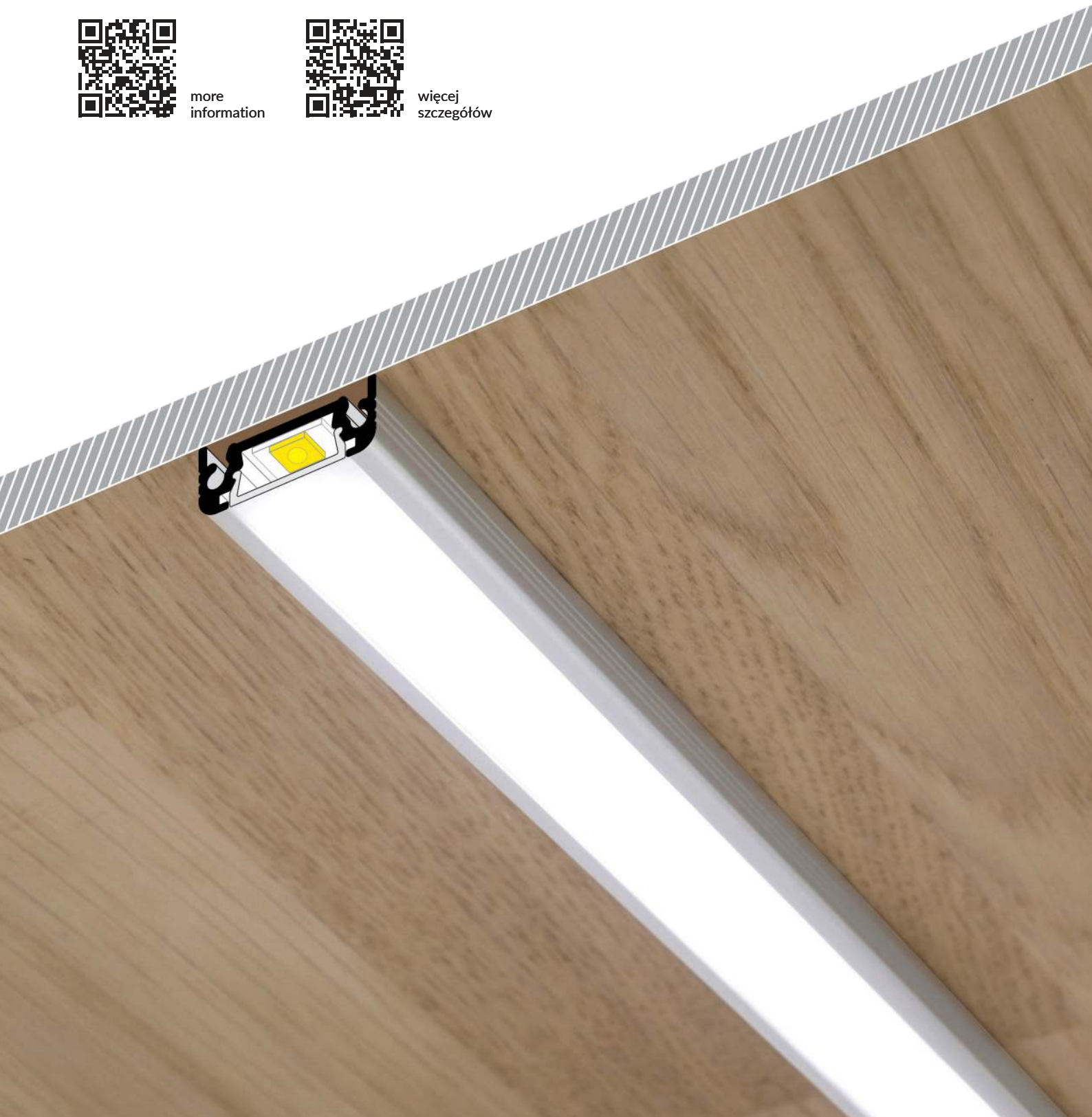

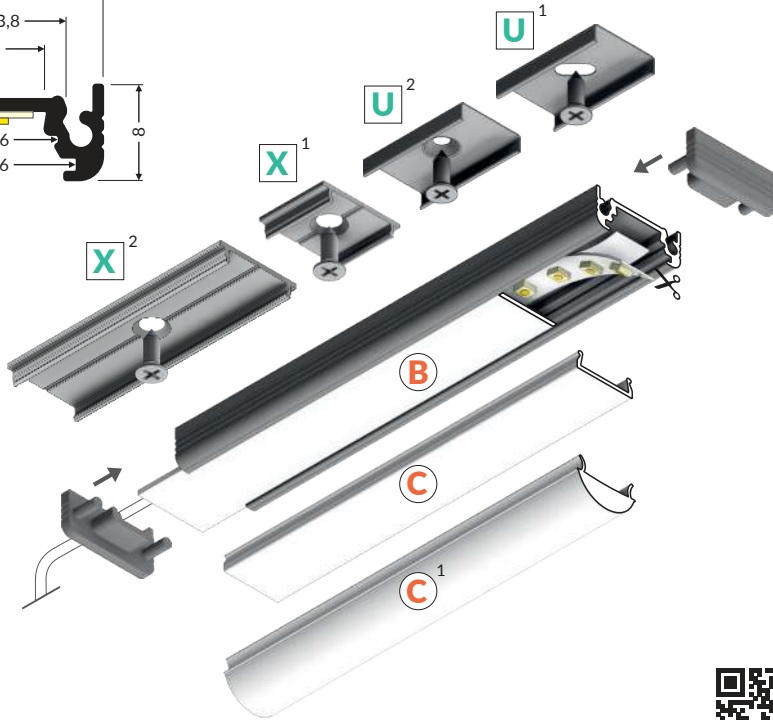
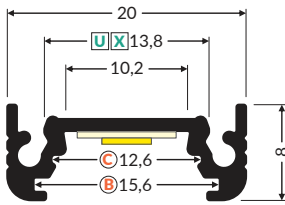

Technical manual
Instrukcja techniczna
Technische Anleitung
Manuel technique



U¹ → 204

mounting plate U
uchwyt U
Halter U
fixation U

U² → 204

mounting plate U cone
uchwyt U cone
Halter U cone
fixation U cône

X¹ → 207

mounting plate X
uchwyt X
Halter X
fixation X

X² → 207

connector X 180 deg
łącznik X 180 st
Verbinder X 180 Grad
connecteur X 180 degrés

B → 194

diffuser B slide
klosz B wsuwany
Abdeckung B einschiebbar
diffuseur B coulissant

C → 195

diffuser C click
klosz C klik
Abdeckung C einclipsbar
diffuseur C clic

C¹ → 195

diffuser C click lens gen2
klosz C klik soczewka gen2
Abdeckung C einclipsbar
Linse gen2
diffuseur C clic lentille gen 2



white painted
biały malowany
weiß lackiert
peint en blanc



anodized
anodowany
eloxiert
surface anodisée



black anodized
czarny anodowany
schwarz eloxiert
noir anodisé



raw aluminium
surowe aluminium
Rohaluminium
aluminium brut

1000 mm	77260001	77260020	77260021	77260000
2000 mm	77270001	77270020	77270021	77270000
3000 mm	77560001	77570020	77570021	77570000
4050 mm	77580001	77580020	77580021	77580000

end cap SURFACE10 gen2
zaślepka SURFACE10 gen2
Endkappe SURFACE10 gen2
embout SURFACE10 gen2



white
biały
weiß
blanc
77990001

silver
srebrny
silbern
argent
77990040

black
czarny
schwarz
noir
77990002

grey
szary
grau
gris
77990022

end cap SURFACE10 gen2 with hole
zaślepka SURFACE10 gen2 z otworem
Endkappe SURFACE10 gen2 mit Öffnung
embout SURFACE10 gen2 avec un trou



white
biały
weiß
blanc
77980001

silver
srebrny
silbern
argent
77980040

black
czarny
schwarz
noir
77980002

grey
szary
grau
gris
77980022

connector SURFACE10 90 deg
łącznik SURFACE10 90 st
Verbinder SURFACE10 90 Grad
connecteur SURFACE10 90 degrés

material: aluminium
materiał: aluminium
Material: Aluminium
matériel: aluminium

white painted
biały malowany
weiß lackiert
peint en blanc
77410001

anodized
anodowany
eloxiert
surface anodisée
77410020

black anodized
czarny anodowany
schwarz eloxiert
noir anodisé
77410021

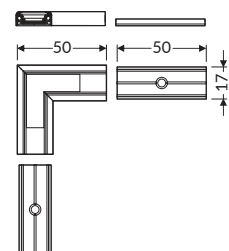

SURFACE10.v2 BC/U



max 10 mm



surface
nawierzchniowe
Aufbauprofile
surface



furniture
meblowe
Möbel-
mobilier

- a new generation of surface profiles
- basic and aesthetically pleasing furniture profile
- concealed fixing
- reduced weight
- updated design

- nowa generacja profili nawierzchniowych
- podstawowy i estetyczny profil meblowy
- ukryte mocowanie
- zredukowana waga
- odświeżony design

- neue Generation von Abdeckprofilen
- einfaches und ästhetisches Möbelprofil
- versteckte Verankerung
- reduziertes Gewicht
- aufgefrishtes Design

- nouvelle génération des profilés de surface
- profilé de mobilier basique et esthétique
- fixation cachée
- poids réduit
- design rafraîchi



more
information



więcej
szczegółów

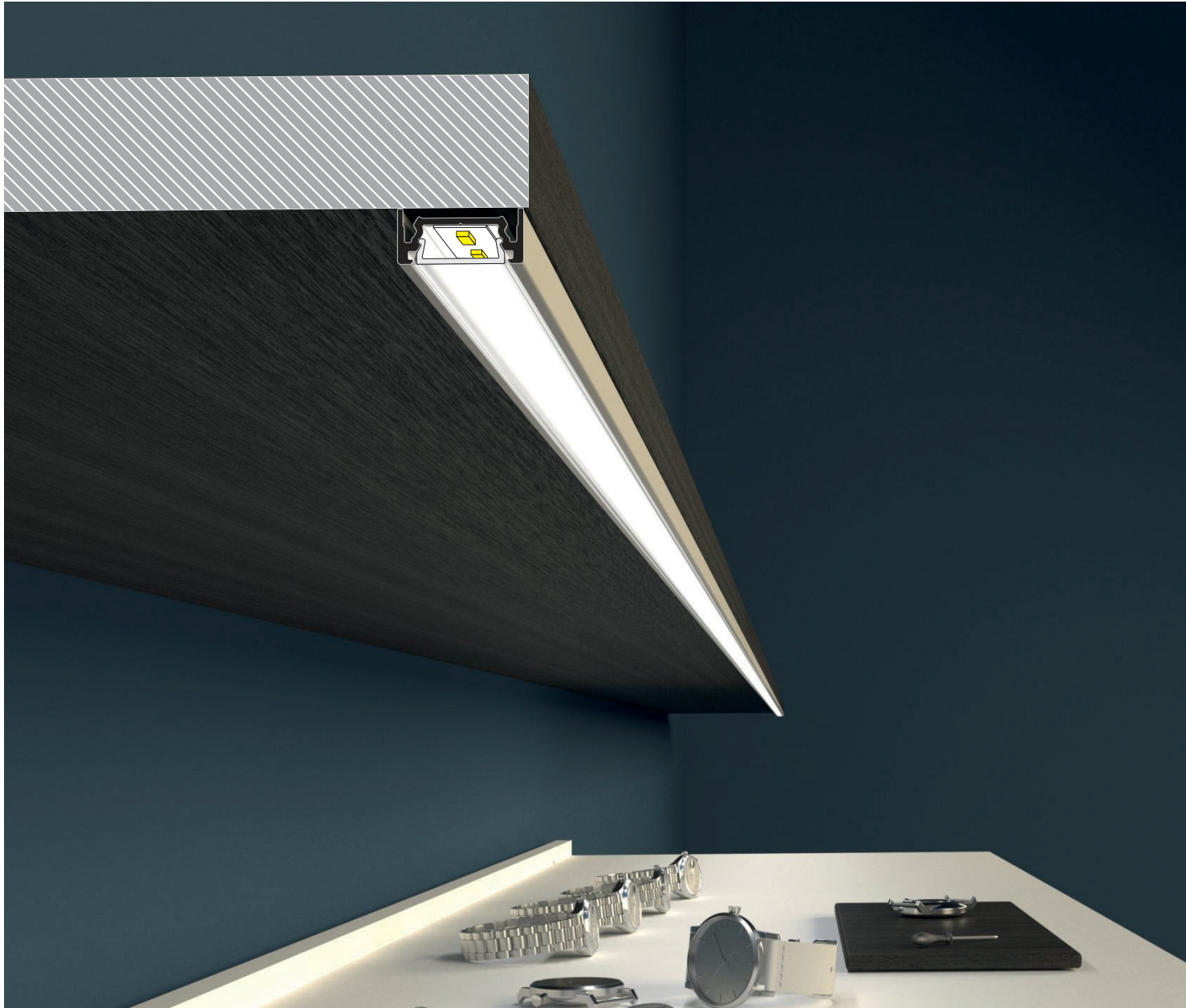

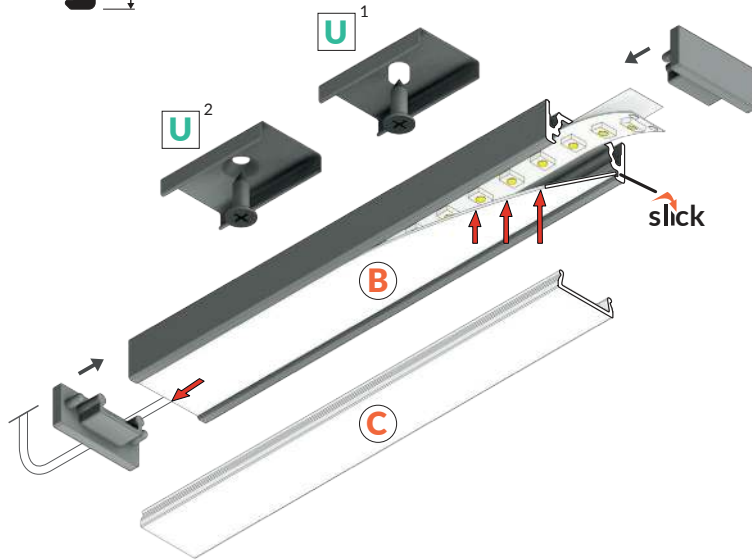
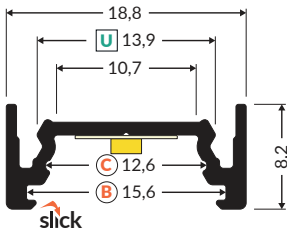

U¹ → 204

mounting plate U
uchwyt U
Halter U
fixation U

U² → 204

mounting plate U cone
uchwyt U cone
Halter U cone
fixation U cône

B → 194

diffuser B slide
klosz B wsuwany
Abdeckung B einschiebbar
diffuseur B coulissant

C → 195

diffuser C click
klosz C klik
Abdeckung C einclipsbar
diffuseur C clic



white painted
biały malowany
weiß lackiert
peint en blanc



anodized
anodowany
eloxiert
surface anodisée



black anodized
czarny anodowany
schwarz eloxiert
noir anodisé



raw aluminium
surowe aluminium
Rohaluminium
aluminium brut

1000 mm	K3000101	K3000120	K3000121	K3000100
2000 mm	K3000201	K3000220	K3000221	K3000200
3000 mm	K3000301	K3000320	K3000321	K3000300
4050 mm	K3000401	K3000420	K3000421	K3000400

end cap SURFACE10.v2
zaślepka SURFACE10.v2
Endkappe SURFACE10.v2
embout SURFACE10.v2

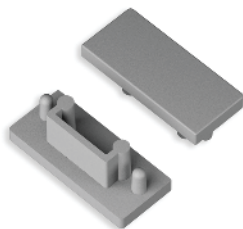

white
biały
weiß
blanc
K3999901

silver
srebrny
silbern
argent
K3999940

black
czarny
schwarz
noir
K3999902

grey
szary
grau
gris
K3999922



SURFACE14 EE7F/TY



max 14 mm



surface
nawierzchniowe
Aufbauprofile
surface



furniture
meblowe
Möbel-
mobilier

- hidden mounting
- many system accessories
available

- ukryte mocowanie
- wiele akcesoriów
systemowych do wyboru

- eine versteckte Befestigung
- viele Systemzubehörteile zur
Auswahl

- fixation cachée
- de nombreux accessoires du
système au choix



more
information



więcej
szczegółów

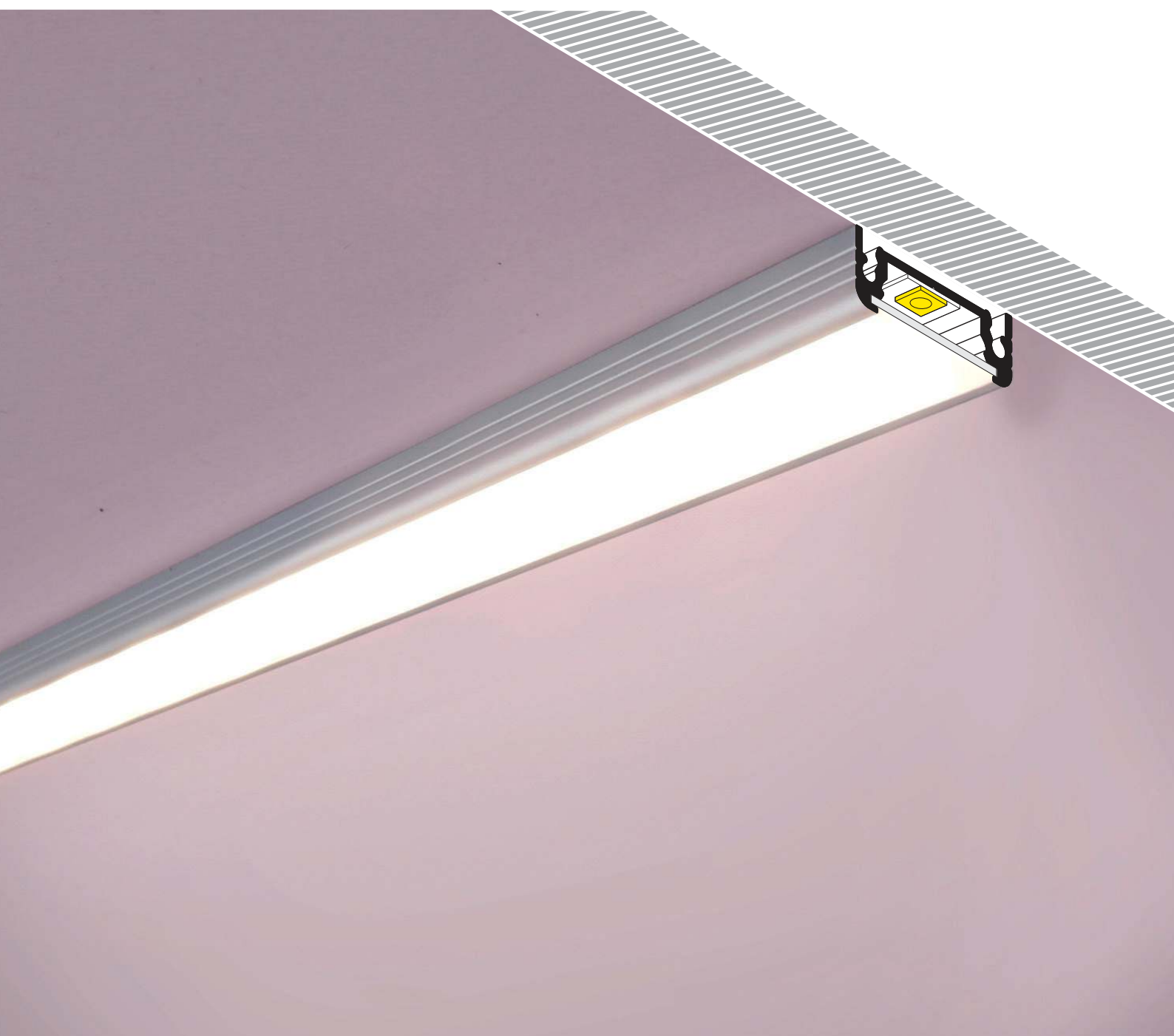

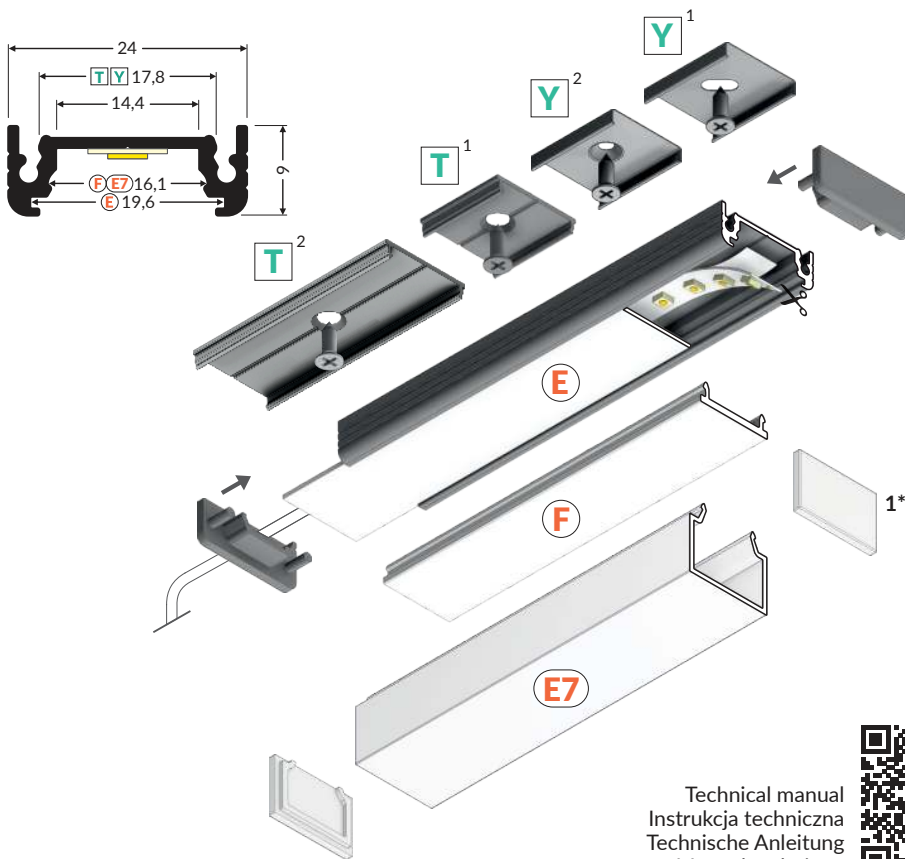

Y¹ → 208

mounting plate Y
uchwyt Y
Halter Y
fixation Y

Y² → 208

mounting plate Y cone
uchwyt Y cone
Halter Y cone
fixation Y cône

T¹ → 204

mounting plate T
uchwyt T
Halter T
fixation T

T² → 204

connector T 180 deg
łącznik T 180 st
Verbinder T 180 Grad
connecteur T 180 degrés

E → 198

diffuser E slide
klosz E wsuwany
Abdeckung E einschiebbar
diffuseur E coulissant

F → 199

diffuser F click
klosz F klik
Abdeckung F einclipsbar
diffuseur F clic

E7 → 198

diffuser E7 click
klosz E7 klik
Abdeckung E7 einclipsbar
diffuseur E7 clic

1* → 198

end cap E7
zaślepka E7
Endkappe E7
embout E7

Technical manual
Instrukcja techniczna
Technische Anleitung
Manuel technique



white painted biały malowany weiß lackiert peint en blanc	anodized anodowany eloxiert surface anodisée	black anodized czarny anodowany schwarz eloxiert noir anodisé	raw aluminium surowe aluminium Rohaluminium aluminium brut
1000 mm A2010001	A2010020	A2010021	A2010000
2000 mm A2020001	A2020020	A2020021	A2020000
3000 mm A2170001	A2170020	A2170021	A2170000
4050 mm A2180001	A2180020	A2180021	A2180000

end cap SURFACE14 gen2
zaślepka SURFACE14 gen2
Endkappe SURFACE14 gen2
embout SURFACE14 gen2



white biały weiß blanc	silver srebrny silbern argent
A2980001	A2980040

black czarny schwarz noir	grey szary grau gris
A2980002	A2980022

end cap SURFACE14 gen2 with hole
zaślepka SURFACE14 gen2 z otworem
Endkappe SURFACE14 gen2 mit Öffnung
embout SURFACE14 gen2 avec un trou



white biały weiß blanc	silver srebrny silbern argent
A2970001	A2970040

black czarny schwarz noir	grey szary grau gris
A2970002	A2970022

connector SURFACE14
łącznik SURFACE14 90 st
Verbinder SURFACE14 90 Grad
connecteur SURFACE14 90 degrés

material: aluminium
materiał: aluminium
Material: Aluminium
matériel: aluminium

white painted
biały malowany
weiß lackiert
peint en blanc
A2990001

anodized
anodowany
eloxiert
surface anodisée
A2990020

black anodized
czarny anodowany
schwarz eloxiert
noir anodisé
A2990021

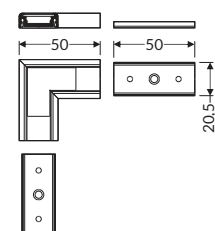

SURFACE14.v2 EE7F/Y



max 14 mm



surface
nawierzchniowe
Aufbauprofile
surface



furniture
meblowe
Möbel-
mobilier

- a new generation of surface profiles
- basic and aesthetically pleasing furniture profile
- concealed fixing
- reduced weight
- updated design

- nowa generacja profili nawierzchniowych
- podstawowy i estetyczny profil meblowy
- ukryte mocowanie
- zredukowana waga
- odświeżony design

- neue Generation von Aufbauprofilen
- einfaches und ästhetisches Möbelprofil
- versteckte Befestigung
- reduziertes Gewicht
- aufgefrishtes Design

- nouvelle génération de profils de surface
- profilé de mobilier basique et esthétique
- fixation cachée
- poids réduit
- design rafraîchi



more
information



więcej
szczegółów



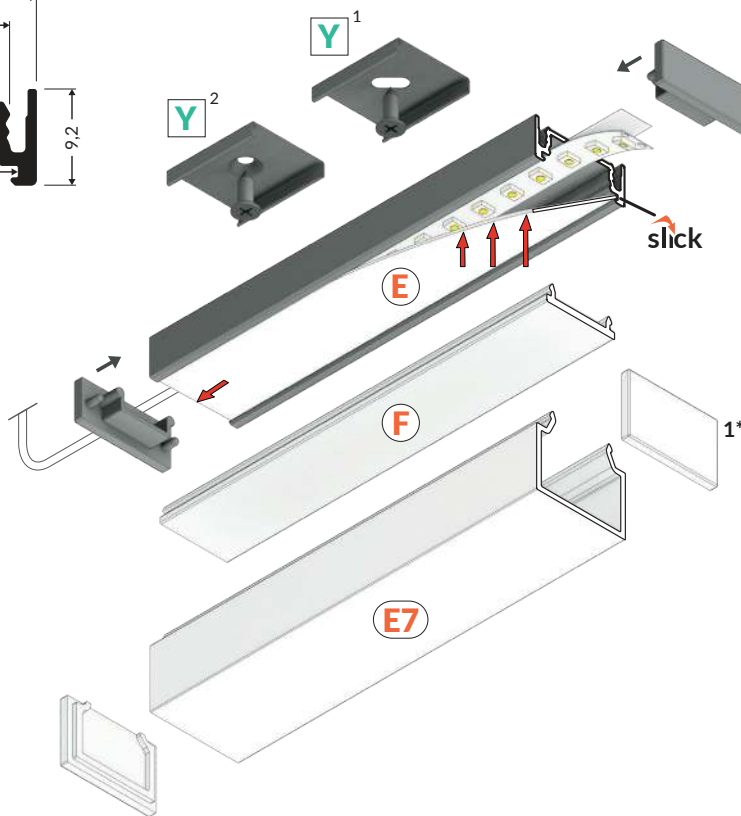
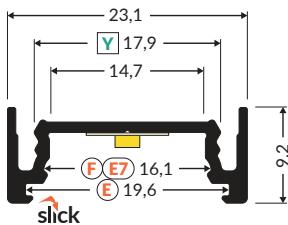

Y¹ → 208

mounting plate Y
uchwyt Y
Halter Y
fixation Y

Y² → 208

mounting plate Y cone
uchwyt Y cone
Halter Y cone
fixation Y cône

E → 198

diffuser E slide
klosz E wsuwany
Abdeckung E einschiebbar
diffuseur E coulissant

F → 199

diffuser F click
klosz F klik
Abdeckung F einclipsbar
diffuseur F clic

E7 → 198

diffuser E7 click
klosz E7 klik
Abdeckung E7 einclipsbar
diffuseur E7 clic

1* → 198

end cap E7
zaślepka E7
Endkappe E7
embout E7



white painted
biały malowany
weiß lackiert
peint en blanc



anodized
anodowany
eloxiert
surface anodisée



black anodized
czarny anodowany
schwarz eloxiert
noir anodisé



raw aluminium
surowe aluminium
Rohaluminium
aluminium brut

1000 mm	K4000101	K4000120	K4000121	K4000100
2000 mm	K4000201	K4000220	K4000221	K4000200
3000 mm	K4000301	K4000320	K4000321	K4000300
4050 mm	K4000401	K4000420	K4000421	K4000400

end cap SURFACE14.v2
zaślepka SURFACE14.v2
Endkappe SURFACE14.v2
embout SURFACE14.v2

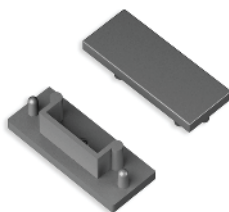

white
biały
weiß
blanc
K4999901

silver
srebrny
silbern
argent
K4999940

black
czarny
schwarz
noir
K4999902

grey
szary
grau
gris
K4999922



SMART16 BC3/U4



max 16 mm



surface
nawierzchniowe
Aufbauprofile
surface



furniture
meblowe
Möbel-
mobilier

- Slick socket - easy assembly technology
- 2 channels for mounting bracket (with or without mounting surface distance)
- continuous line of light (when using LED strip 120 P/m and opal diffuser)

- gniazdo Slick - prosty montaż klosza
- 2 rowki - 2 poziomy przymocowania uchwyty (z dystansem od płaszczyzny montażowej lub bez)
- ciągła linia światła (przy zastosowaniu taśmy 120 P/m i klosza mlecznego)

- Sockel mit Slick Funktion
- eine einfache Montage der Abdeckung
- zwei Rillen - zwei Niveaus der Befestigung des Halters (mit einem Abstand von der Montagefläche und ohne Abstand)
- eine homogene Lichtlinie (unter Verwendung von LED Streifen mit 120 leds/m und einer opalen Abdeckung)

- prise avec fonction Slick - installation simple du diffuseur
- 2 rainures - 2 niveaux de montage de la fixation (avec ou sans distance de la surface de montage)
- une ligne continue de lumière (en utilisant un ruban 120 P/M. et un diffuseur opaque)



more
information



więcej
szczegółów



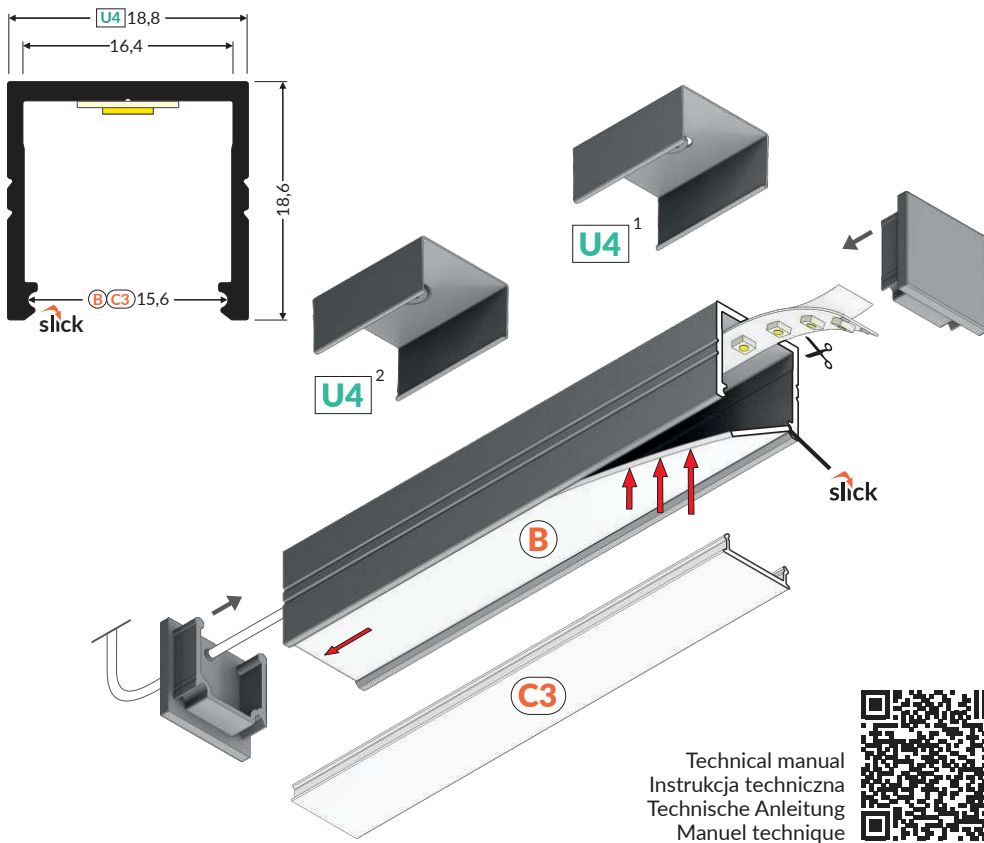

U4¹ → 205

mounting plate U4
uchwyt U4
Halter U4
fixation U4

U4² → 205

mounting plate U4 cone
uchwyt U4 cone
Halter U4 cone
fixation U4 cône

B → 194

diffuser B slide
klosz B wsuwany
Abdeckung B einschiebbar
diffuseur B coulissant

C3 → 196

diffuser C3 click
klosz C3 klik
Abdeckung C3 einclipsbar
diffuseur C3 clic

Technical manual
Instrukcja techniczna
Technische Anleitung
Manuel technique

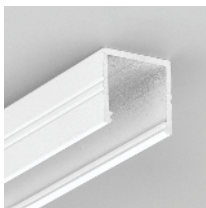

white painted
biały malowany
weiß lackiert
peint en blanc



anodized
anodowany
eloxiert
surface anodisée



black anodized
czarny anodowany
schwarz eloxiert
noir anodisé



raw aluminium
surowe aluminium
Rohaluminium
aluminium brut

1000 mm	F1010001	F1010020	F1010021	F1010000
2000 mm	F1020001	F1020020	F1020021	F1020000
3000 mm	F1030001	F1030020	F1030021	F1030000
4050 mm	F1040001	F1040020	F1040021	F1040000

end cap SMART16-BC3
zaślepka SMART16-BC3
Endkappe SMART16-BC3
embout SMART16-BC3



white
biały
weiß
blanc
F1999901

silver
srebrny
silbern
argent
F1999940

black
czarny
schwarz
noir
F1999902

grey
szary
grau
gris
F1999922

LINEA20 EE7F/TY



max 20 mm



surface
nawierzchniowe
Aufbauprofile
surface



suspended
zwieszane
hängend
suspendu



furniture
meblowe
Möbel-
mobilier



lighting
oświetleniowe
Beleuchtungs-
éclairage d'ambiance

- over 20 accessories available
- possibility of suspension along with the power supply
- angled connections illuminated
- continuous light line (with 120 LEDs/m and opal diffuser applied)

- ponad 20 akcesoriów
- możliwość zawieszenia na zasilaniu
- świecące połączenia kątowe
- ciągła linia światła (przy użyciu taśm 120 P/m oraz klosza mlecznego)

- mehr als 20 Zubehörteile
- die Möglichkeit auf der Speisung aufzuhängen
- leuchtende Eckverbindungen
- eine homogene Lichtlinie (bei LED Streifen mit 120 LEDs/m und einer opalen Abdeckung)

- plus de 20 accessoires
- possibilité d'alimentation via la suspension
- connecteurs d'angles éclairés
- une ligne continue de lumière (en utilisant de rubans 120 LED/m et diffuseur opaque)



more
information



więcej
szczegółów



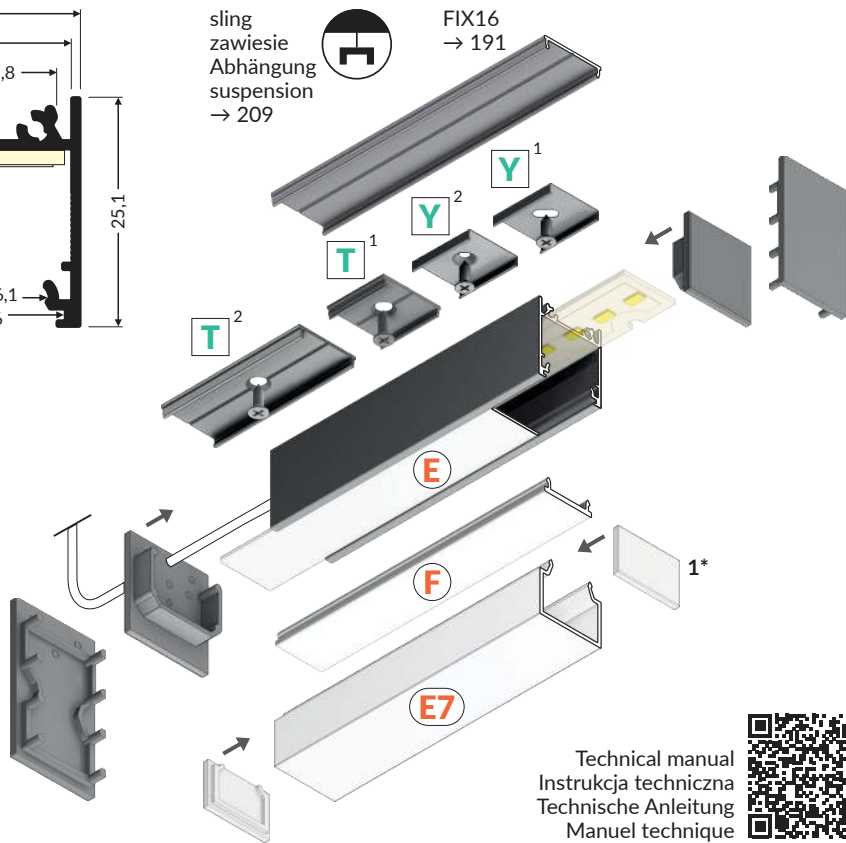
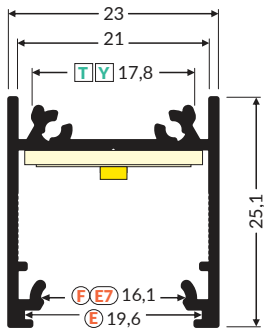

Technical manual
Instrukcja techniczna
Technische Anleitung
Manuel technique



Y¹ → 208

mounting plate Y
uchwyt Y
Halter Y
fixation Y

Y² → 208

mounting plate Y cone
uchwyt Y cone
Halter Y cone
fixation Y cône

T¹ → 204

mounting plate T
uchwyt T
Halter T
fixation T

T² → 204

connector T 180 deg
łącznik T 180 st
Verbinder T 180 Grad
connecteur T 180 degrés

E → 198

diffuser E slide
klosz E wsuwany
Abdeckung E einschiebbar
diffuseur E coulissant

F → 199

diffuser F click
klosz F klik
Abdeckung F einclipsbar
diffuseur F clic

E7 → 198

diffuser E7 click
klosz E7 klik
Abdeckung E7 einclipsbar
diffuseur E7 clic

1* → 198

end cap E7
zaślepka E7
Endkappe E7
embout E7

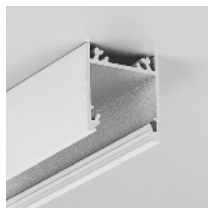

white painted
biały malowany
weiß lackiert
peint en blanc



anodized
anodowany
eloxiert
surface anodisée



black anodized
czarny anodowany
schwarz eloxiert
noir anodisé



raw aluminium
surowe aluminium
Rohaluminium
aluminium brut

1000 mm	C1010001	C1010020	C1010021	C1010000
2000 mm	C1020001	C1020020	C1020021	C1020000
3000 mm	C1050001	C1050020	C1050021	C1050000
4050 mm	C1060001	C1060020	C1060021	C1060000

end cap LINEA20
zaślepka LINEA20
Endkappe LINEA20
embout LINEA20



white biały weiß blanc	silver srebrny silbern argent	C1940001	C1940040
black czarny schwarz noir	grey szary grau gris	C1940002	C1940022

end cap LINEA20-E7
zaślepka LINEA20-E7
Endkappe LINEA20-E7
embout LINEA20-E7



white biały weiß blanc	silver srebrny silbern argent	C1999901	C1999940
black czarny schwarz noir	grey szary grau gris	C1999902	C1999922

LED mounting LINEA20
mocowanie LED LINEA20
LED Montageteil LINEA20
fixation LED LINEA20



raw aluminium
surowe aluminium
Rohaluminium
aluminium brut

1000 mm	C6050000
2000 mm	C6060000
3000 mm	C6070000
4050 mm	C6080000

material: aluminium
material: aluminium
Material: Aluminium
matériel: aluminium

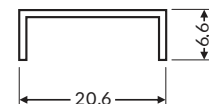



SLING ZAWIESIE ABHÄNGUNG SUSPENSION

sling for LED mounting 1500
zawiesie do uchwytu LED 1500
Abhängung für LED Profil-Halter 1500
kit de suspension pour support LED 1500

colour: chrome
kolor: chrom
Farben: Chrom
couleur: chrom

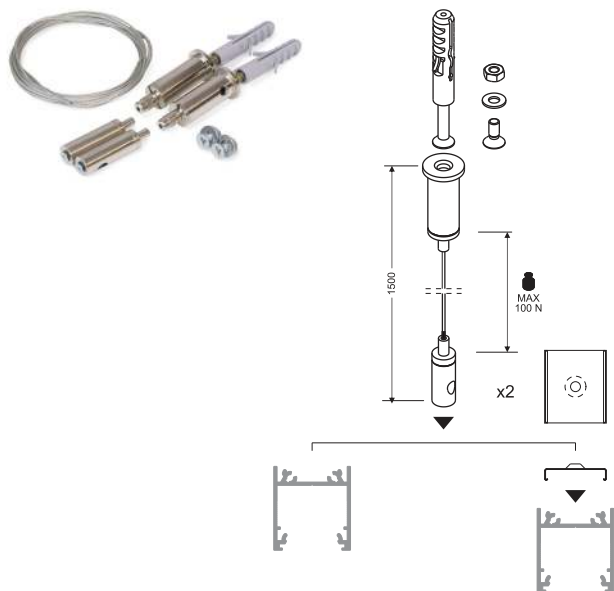

SLING FOR LED MOUNTING 1500

Compatible with flexible mounting plates, allows fast and easy assembly of the luminaire mounting to the profile.

ZAWIESIE DO UCHWYTU LED 1500

Kompatybilność z uchwytami sprężystymi, pozwala na szybki i łatwy montaż oprawy. Możliwy jest również montaż bezpośrednio do profilu.

ABHÄNGUNG FÜR LED PROFIL-HALTER 1500

Die Anpassung an die flexiblen Halter ermöglicht eine schnelle und einfache Montage der Leuchte. Möglich ist auch die Montage direkt an das Profil.

KIT DE SUSPENSION POUR SUPPORT LED 1500.

La compatibilité avec les supports flexibles permet un montage rapide et facile du luminaire. Il est également possible de le monter directement sur le profilé.

SELV sling 50 V 1500
zawiesie SELV 50 V 1500
Abhängung SELV 50V 1500
kit de suspension SELV 50 V 1500

colours: white, silver, black
kolory: biały, srebrny, czarny
Farben: weiß, silbern, schwarz
couleurs: blanc, argent, noir

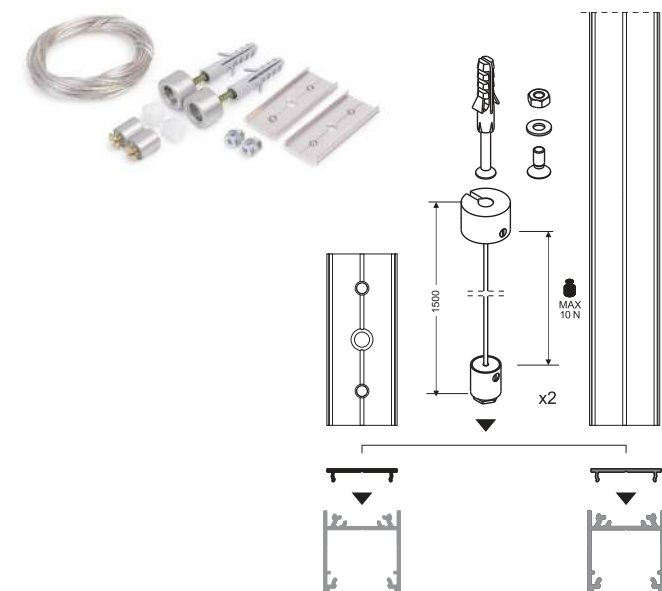

SELV SLING 50 V 1500

It provides a minimalistic look - no additional wires required.

ZAWIESIE SELV 50 V 1500

Zapewnia minimalistyczny wygląd - bez konieczności doprowadzania dodatkowych przewodów.

ABHÄNGUNG SELV 50 V 1500

Sie sichert schlichtes Aussehen - ohne die Notwendigkeit zusätzliche Kabel durchzuführen.

KIT DE SUSPENSION SELV 50 V 1500

Fournit un look minimaliste - sans avoir besoin de câbles supplémentaires.

Using FIX16 profile creates an aesthetic, closed form

Przy zastosowaniu profilu FIX16 tworzymy estetyczną, domkniętą od góry oprawę.

Bei dem Anwenden von dem Profil FIX16 bildet man eine ästhetische von oben geschlossene Leuchte.

Lors de l'utilisation du profilé FIX16, nous créons un cadre esthétique, fermé par le haut.

CONNECTION POSSIBILITY

MOŻLIWOŚCI ŁĄCZENIA

VERBINDUNGSMÖGLICHKEITEN

COMBINAISON POSSIBLE

ANGULAR CONNECTORS

Thanks to five different angle connectors (60° / 90° / 120° / 135° / 180°) it is possible to create many various lighting systems – with no need to cut the profile at an angle. Bent connectors allows to connect profiles in two planes, at two angles: 90° on the inside and 270° on the outside.

ŁĄCZNIKI KĄTOWE

Dzięki łącznikom o pięciu różnych kątach (60° / 90° / 120° / 135° / 180°) możliwe jest tworzenie wielu różnych układów oświetlenia bez konieczności cięcia profilu pod skosem. Łączniki gięte umożliwiają łączenie profili w dwóch płaszczyznach, pod dwoma kątami: wewnętrznym 90° i zewnętrznym 270°.

ECKVERBINDER

Dank den Eckverbindern mit fünf unterschiedlichen Winkeln (60° / 90° / 120° / 135° / 180°) möglich ist die Bildung von vielen unterschiedlichen Lichtvarianten ohne das Profil auf Gehrung zuschneiden müssen. Gebogene Verbindungsstücke ermöglichen das Verbinden von zwei Profilen in zwei Ebenen, unter zwei Winkeln; dem inneren Winkel von 90° und dem äußeren Winkel von 270°.

CONNECTEURS D'ANGLES

Grâce à des connecteurs avec cinq angles différents (60° / 90° / 120° / 135° / 180°), il est possible de créer de nombreux systèmes d'éclairage différents sans qu'il soit nécessaire de couper le profilé en angle. Les connecteurs coudés vous permettent de connecter des profilés dans deux plans, à deux angles: 90° interne et 270° externe.

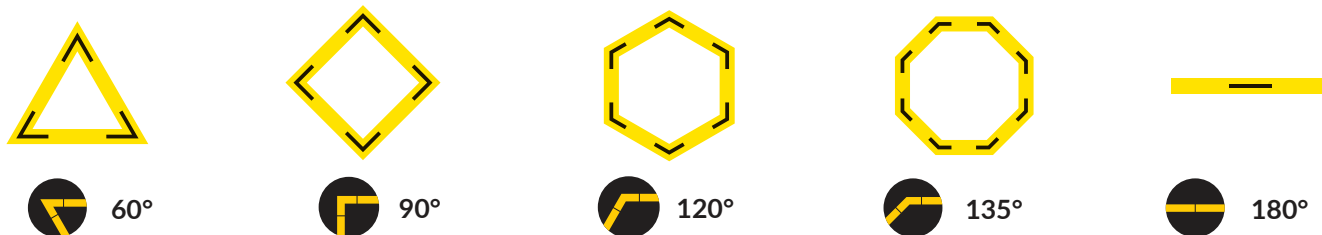

The component made of clear fabric provides secure connection, letting light through at the same time. Thanks to that, the luminaire can illuminate on the entire surface of the diffuser – even in the corners.

Element z przezroczystego tworzywa zapewnia stabilizację łączenia, jednocześnie przepuszczając światło. Dzięki temu oprawa może świecić na całej powierzchni klosza - również w rogach.

Ein Element aus durchsichtigem Kunststoff sichert die Stabilisierung der Verbindung und gleichzeitig lässt das Licht durch. Dadurch kann die Leuchte auf der ganzen Fläche der Abdeckung leuchten - auch in den Ecken.



Un élément en matériau transparent assure la stabilisation de la connexion, tout en laissant passer la lumière. Grâce à cela, le luminaire peut briller sur toute la longueur, même dans les angles

CONNECTORS ŁĄCZNIKI VERBINDER CONNECTEURS

material: aluminium, polycarbonate
materiał: aluminium, poliwęglan
Material: Aluminium, polycarbonate
matériel: aluminium, polycarbonate

connector LINEA20 60 deg
łącznik LINEA20 60 st
Verbinder LINEA20 60 Grad
connecteur LINEA20 60 degrés

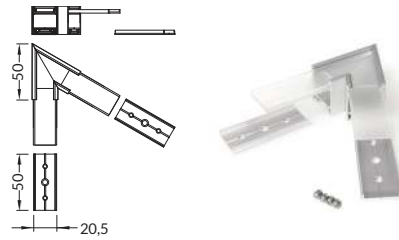

white painted
biały malowany
weiß lackiert
peint en blanc
C1850001

anodized
anodowany
eloxiert
surface anodisée
C1850020

black anodized
czarny anodowany
schwarz eloxiert
noir anodisé
C1850002

connector LINEA20 90 deg
łącznik LINEA20 90 st
Verbinder LINEA20 90 Grad
connecteur LINEA20 90 degrés

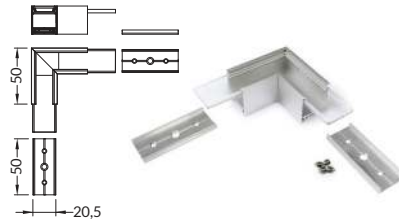

white painted
biały malowany
weiß lackiert
peint en blanc
C1860001

anodized
anodowany
eloxiert
surface anodisée
C1860020

black anodized
czarny anodowany
schwarz eloxiert
noir anodisé
C1860002

connector LINEA20 90 deg bent
łącznik LINEA20 90 st gięty
Verbinder LINEA20 90 Grad gebogen
connecteur LINEA20 90 degrés plié

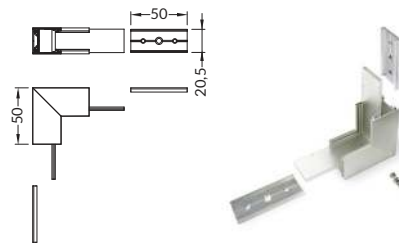

white painted
biały malowany
weiß lackiert
peint en blanc
C1870001

anodized
anodowany
eloxiert
surface anodisée
C1870020

black anodized
czarny anodowany
schwarz eloxiert
noir anodisé
C1870002

connector LINEA20 120 deg
łącznik LINEA20 120 st
Verbinder LINEA20 120 Grad
connecteur LINEA20 120 degrés

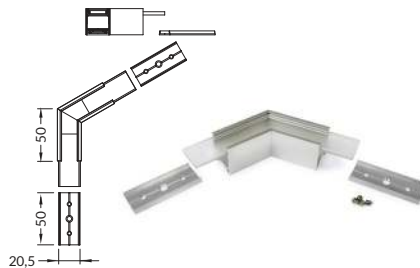

white painted
biały malowany
weiß lackiert
peint en blanc
C1880001

anodized
anodowany
eloxiert
surface anodisée
C1880020

black anodized
czarny anodowany
schwarz eloxiert
noir anodisé
C1880002

connector LINEA20 135 deg
łącznik LINEA20 135 st
Verbinder LINEA20 135 Grad
connecteur LINEA20 135 degrés

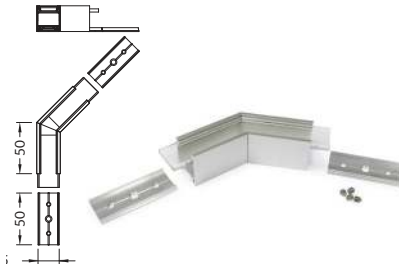

white painted
biały malowany
weiß lackiert
peint en blanc
C1890001

anodized
anodowany
eloxiert
surface anodisée
C1890020

black anodized
czarny anodowany
schwarz eloxiert
noir anodisé
C1890002

connector LINEA20 180 deg
łącznik LINEA20 180 st
Verbinder LINEA20 180 Grad
connecteur LINEA20 180 degrés



C1900000

connector LINEA20 270 deg bent
łącznik LINEA20 270 st gięty
Verbinder LINEA20 270 Grad gebogen
connecteur LINEA20 270 degrés plié

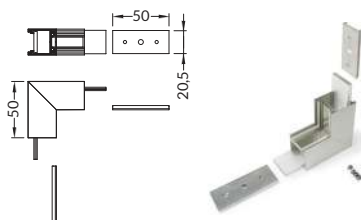

white painted
biały malowany
weiß lackiert
peint en blanc
C1910001

anodized
anodowany
eloxiert
surface anodisée
C1910020

black anodized
czarny anodowany
schwarz eloxiert
noir anodisé
C1910002



max 24 mm



surface
nawierzchniowe
Aufbauprofile
surface



furniture
meblowe
Möbel-
mobilier

- possibility of installing
3 parallel 8 mm LED strips
- Slick socket

- możliwość zastosowania
równoległe 3 taśm 8 mm
- gniazdo z funkcją Slick

- man kann gleichzeitig
3 LED-Streifen mit 8mm
Breite verwenden
- Sockel mit Slick Funktion

- 3 rubans de 8 mm peuvent
être utilisés en parallèle
- prise avec fonction Slick



more
information



więcej
szczegółów



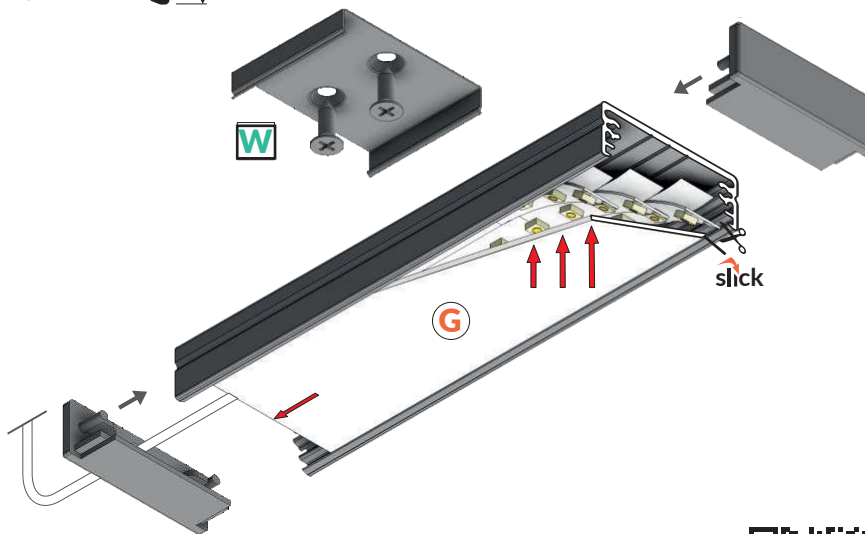
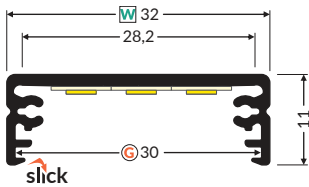

W → 207

mounting plate W cone
uchwyt W cone
Halter W cone
fixation W cone /cône

G → 199

diffuser G slide
klosz G wsuwany
Abdeckung G einschiebbar
diffuseur G coulissant

Technical manual
Instrukcja techniczna
Technische Anleitung
Manuel technique



white painted
biały malowany
weiß lackiert
peint en blanc



anodized
anodowany
eloxiert
surface anodisée



black anodized
czarny anodowany
schwarz eloxiert
noir anodisé



raw aluminium
surowe aluminium
Rohaluminium
aluminium brut

1000 mm	84020001	84020020	84020021	84020000
2000 mm	84030001	84030020	84030021	84030000
3000 mm	84340001	84340020	84340021	84340000
4050 mm	84350001	84350020	84350021	84350000

end cap WIDE24
zaślepka WIDE24
Endkappe WIDE24
embout WIDE24



white
biały
weiß
blanc

84040001 **84040040**

black
czarny
schwarz
noir

84040002 **84040022**

end cap WIDE24 with hole
zaślepka WIDE24 z otworem
Endkappe WIDE24 mit Öffnung
embout WIDE24 avec un trou



white
biały
weiß
blanc

84300001 **84300040**

black
czarny
schwarz
noir

84300002 **84300022**



max 30 mm



surface
nawierzchniowe
Aufbauprofile
surface



suspended
zwieszane
ausgesetzt
suspendu



lighting
oświetleniowe
Beleuchtungs
éclairage

- part of a larger system for luminaire construction
- multiple installation methods
- continuous line of light in angled connections
- unlimited possibilities for light creation

- część większego systemu do budowy opraw oświetleniowych
- wiele sposobów montażu
- ciągła linia światła w połączeniach kątowych
- nieograniczone możliwości kreowania światła

- Teil eines größeren Systems für den Leuchtenbau
- mehrere Montagethoden
- eine homogene Lichtlinie in Eckverbindungen
- unbegrenzte Möglichkeiten der Lichtgestaltung

- partie d'un très vaste système pour la création de luminaires
- des plusieurs options de montage
- une ligne lumineuse permanente dans les connecteurs angulaires
- des possibilités illimitées concernant la création de lumière



VARIO30-01
ACDE-9/TY

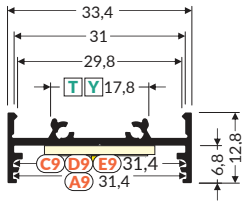

sling
zawiesz
Abhängung
suspension
→ 209



FIX16
→ 191

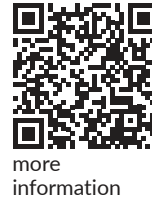
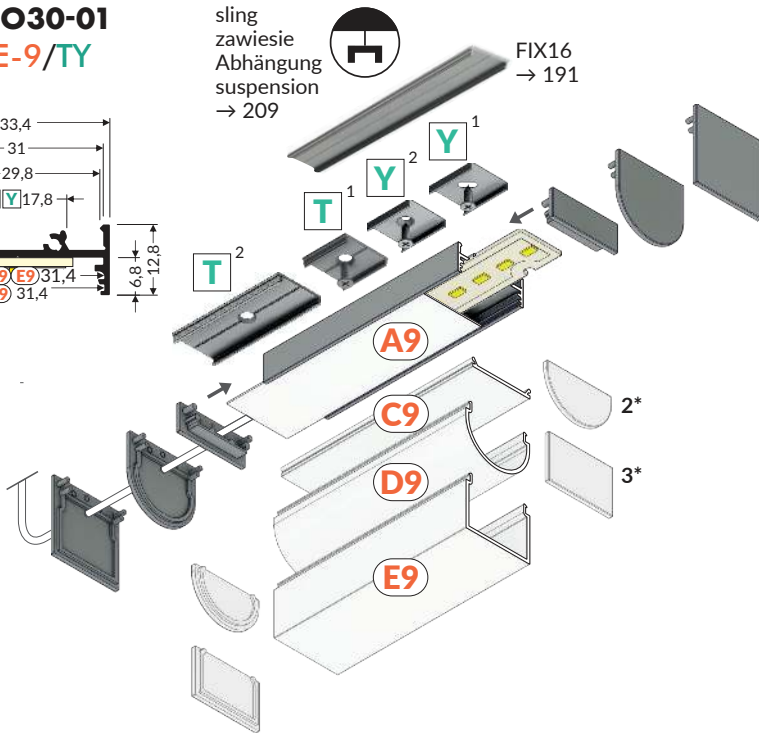

Technical manual
Instrukcja techniczna
Technische Anleitung
Manuel technique

Y¹ → 208

mounting plate Y
uchwyt Y
Halter Y
fixation Y

Y² → 208

mounting plate Y cone
uchwyt Y cone
Halter Y cone
fixation Y cône

T¹ → 204

mounting plate T
uchwyt T
Halter T
fixation T

T² → 204

connector T 180 deg
łącznik T 180 st
Verbinder T 180 Grad
connecteur T 180 degrés

A9 → 194

diffuser A9 slide
klosz A9 wsuwany
Abdeckung A9 einziehbar
diffuseur A9 coulissant

C9 → 197

diffuser C9 click
klosz C9 klik
Abdeckung C9 einclipsbar
diffuseur C9 clic

D9 → 198

diffuser D9 click
klosz D9 klik
Abdeckung D9 einclipsbar
diffuseur D9 clic

E9 → 199

diffuser E9 click
klosz E9 klik
Abdeckung E9 einclipsbar
diffuseur E9 clic



white painted
biały malowany
weiß lackiert
peint en blanc



anodized
anodowany
eloxiert
surface anodisée



black anodized
czarny anodowany
schwarz eloxiert
noir anodisé



raw aluminium
surowe aluminium
Rohaluminium
aluminium brut

1000 mm	V3010001	V3010020	V3010021	V3010000
2000 mm	V3020001	V3020020	V3020021	V3020000
3000 mm	V3030001	V3030020	V3030021	V3030000
4050 mm	V3040001	V3040020	V3040021	V3040000

end cap VARIO30-01
zaślepka VARIO30-01
Endkappe LINEA20
embout LINEA20



white
biały
weiß
blanc
V4870001 **V4870040**

black
czarny
schwarz
noir
V4870002 **V4870022**

end cap VARIO30-01-D9
zaślepka VARIO30-01-D9
Endkappe VARIO30-01-D9
embout VARIO30-01-D9



opal
mleczny
opal
opaque
V4500038

end cap VARIO30-01-E9
zaślepka VARIO30-01-E9
Endkappe VARIO30-01-E9
embout VARIO30-01-E9

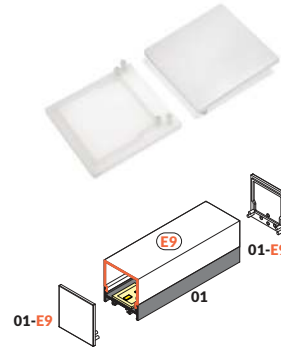

opal
mleczny
opal
opaque
V4510038

2* → 198

end cap D9
zaślepka D9
Endkappe D9
embout D9

3* → 199

end cap E9
zaślepka E9
Endkappe E9
embout E9

VARIO30-02 ACDE-9/TY

sling
zawiesz
Abhängung
suspension
→ 209

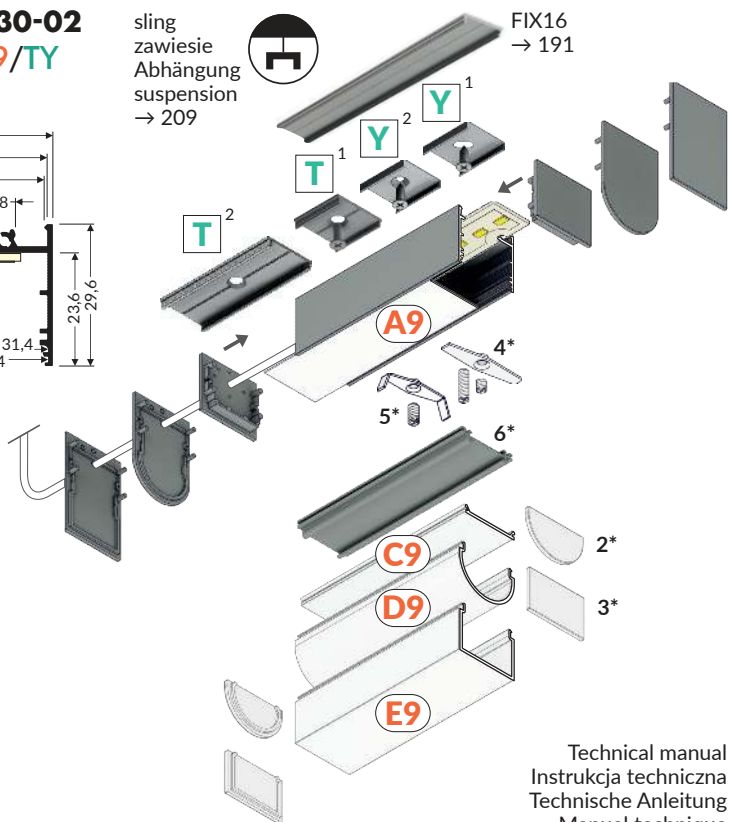
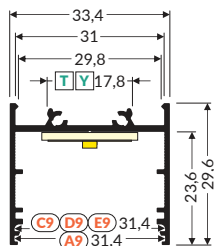

Technical manual
Instrukcja techniczna
Technische Anleitung
Manuel technique



more
information



więcej
szczegółów



Y¹ → 208

mounting plate Y
uchwyt Y
Halter Y
fixation Y

Y² → 208

mounting plate Y cone
uchwyt Y cone
Halter Y cone
fixation Y cône

T¹ → 204

mounting plate T
uchwyt T
Halter T
fixation T

T² → 204

connector T 180 deg
łącznik T 180 st
Verbinde T 180 Grad
connecteur T 180 degrés

A9 → 194

diffuser A9 slide
klosz A9 wsuwany
Abdeckung A9 einziehbar
diffuseur A9 coulissant

C9 → 197

diffuser C9 click
klosz C9 klik
Abdeckung C9 einclipsbar
diffuseur C9 clic

D9 → 198

diffuser D9 click
klosz D9 klik
Abdeckung D9 einclipsbar
diffuseur D9 clic

E9 → 199

diffuser E9 click
klosz E9 klik
Abdeckung E9 einclipsbar
diffuseur E9 clic



white painted
biały malowany
weiß lackiert
peint en blanc



anodized
anodowany
eloxiert
surface anodisée



black anodized
czarny anodowany
schwarz eloxiert
noir anodisé

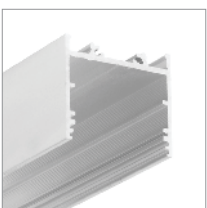

raw aluminium
surowe aluminium
Rohaluminium
aluminium brut

1000 mm	V3050001
2000 mm	V3060001
3000 mm	V3070001
4050 mm	V3080001

1000 mm	V3050020
2000 mm	V3060020
3000 mm	V3070020
4050 mm	V3080020

1000 mm	V3050021
2000 mm	V3060021
3000 mm	V3070021
4050 mm	V3080021

1000 mm	V3050000
2000 mm	V3060000
3000 mm	V3070000
4050 mm	V3080000

end cap VARIO30-02
zaślepka VARIO30-02
Endkappe VARIO30-02
embout VARIO30-02

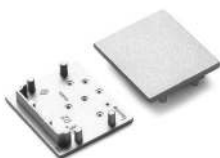

white
biały
weiß
blanc

V4880001 V4880040

black
czarny
schwarz
noir

V4880002 V4880022

silver
srebrny
silbern
argent

V4880040

grey
szary
grau
gris

V4880022

end cap VARIO30-02-D9
zaślepka VARIO30-02-D9
Endkappe VARIO30-02-D9
embout VARIO30-02-D9

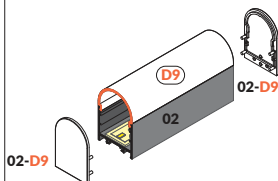

opal
mleczny
opal
opaque

V4540038

end cap VARIO30-02-E9
zaślepka VARIO30-02-E9
Endkappe VARIO30-02-E9
embout VARIO30-02-E9

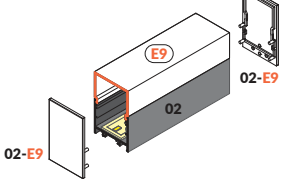

opal
mleczny
opal
opaque

V4550038

2* → 198

end cap D9
zaślepka D9
Endkappe D9
embout D9

3* → 199

end cap E9
zaślepka E9
Endkappe E9
embout E9

4* → 210

LED clamp VARIO30
docisk LED VARIO30
LED Klemme VARIO30
clip de fixation LED VARIO30

5* → 210

LED clamp VARIO30-1
docisk LED VARIO30-1
LED Klemme VARIO30-1
clip de fixation LED VARIO30 1

6* → 210

LED mounting VARIO30
mocowanie LED VARIO30
LED Montagetil VARIO30
barre de fixation LED VARIO30

CONNECTORS ŁĄCZNIKI VERBINDER CONNECTEURS

material: aluminium, polycarbonate
 materiał: aluminium, poliwęglan
 Material: Aluminium, Polycarbonat
 matériel: aluminium, polycarbonate

connector VARIO30-02 60 deg
 łącznik VARIO30-02 60 st
 Verbinder VARIO30-02 60 Grad
 connecteur VARIO30-02 60 degrés

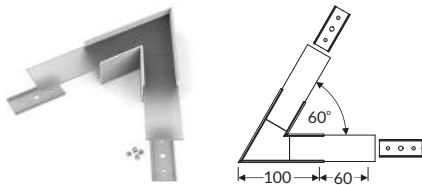

white painted
 biały malowany
 weiß lackiert
 peint en blanc
V466001S

anodized
 anodowany
 eloxiert
 surface anodisée
V466002S

black anodized
 czarny anodowany
 schwarz eloxiert
 noir anodisé
V4660021S

connector VARIO30-02 90 deg
 łącznik VARIO30-02 90 st
 Verbinder VARIO30-02 90 Grad
 connecteur VARIO30-02 90 degrés

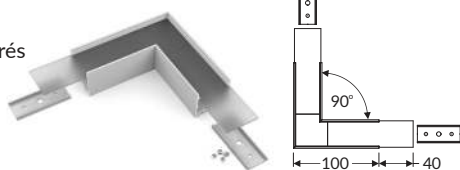

white painted
 biały malowany
 weiß lackiert
 peint en blanc
V467001S

anodized
 anodowany
 eloxiert
 surface anodisée
V467002S

black anodized
 czarny anodowany
 schwarz eloxiert
 noir anodisé
V4670021S

connector VARIO30-02 90 deg bent
 łącznik VARIO30-02 90 st gięty
 Verbinder VARIO30-02 90 Grad gebogen
 connecteur VARIO30-02 90 degrés plié

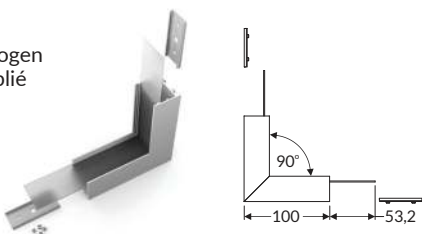

white painted
 biały malowany
 weiß lackiert
 peint en blanc
V468001S

anodized
 anodowany
 eloxiert
 surface anodisée
V468002S

black anodized
 czarny anodowany
 schwarz eloxiert
 noir anodisé
V4680021S

connector VARIO30-02 120 deg
 łącznik VARIO30-02 120 st
 Verbinder VARIO30-02 120 Grad
 connecteur VARIO30-02 120 degrés

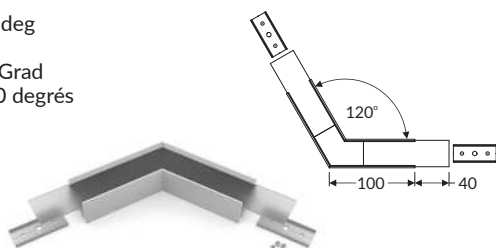

white painted
 biały malowany
 weiß lackiert
 peint en blanc
V469001S

anodized
 anodowany
 eloxiert
 surface anodisée
V469002S

black anodized
 czarny anodowany
 schwarz eloxiert
 noir anodisé
V4690021S

connector VARIO30-02 135 deg
 łącznik VARIO30-02 135 st
 Verbinder VARIO30-02 135 Grad
 connecteur VARIO30-02 135 degrés

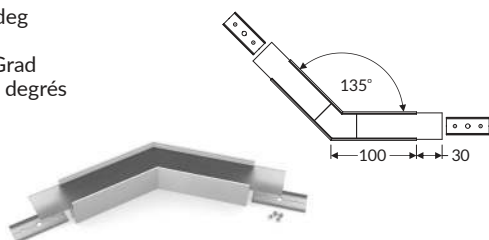

white painted
 biały malowany
 weiß lackiert
 peint en blanc
V470001S

anodized
 anodowany
 eloxiert
 surface anodisée
V470002S

black anodized
 czarny anodowany
 schwarz eloxiert
 noir anodisé
V4700021S

connector VARIO30-0203 180 deg
 łącznik VARIO30-0203 180 st
 Verbinder VARIO30-02 180 Grad
 connecteur VARIO30-02 180 degrés



V464000S

connector VARIO30-02 270 deg bent
 łącznik VARIO30-02 270 st gięty
 Verbinder VARIO30-02 270 Grad gebogen
 connecteur VARIO30-02 270 degrés plié

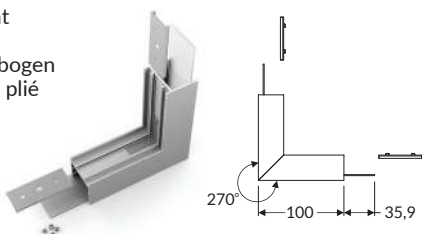

white painted
 biały malowany
 weiß lackiert
 peint en blanc
V471001S

anodized
 anodowany
 eloxiert
 surface anodisée
V471002S

black anodized
 czarny anodowany
 schwarz eloxiert
 noir anodisé
V4710021S



T I Y
FIX16

08

03

power supply
zasilacz
Netzteil
alimentation

variant 32

VARIO30-03
ACDE-9/TY

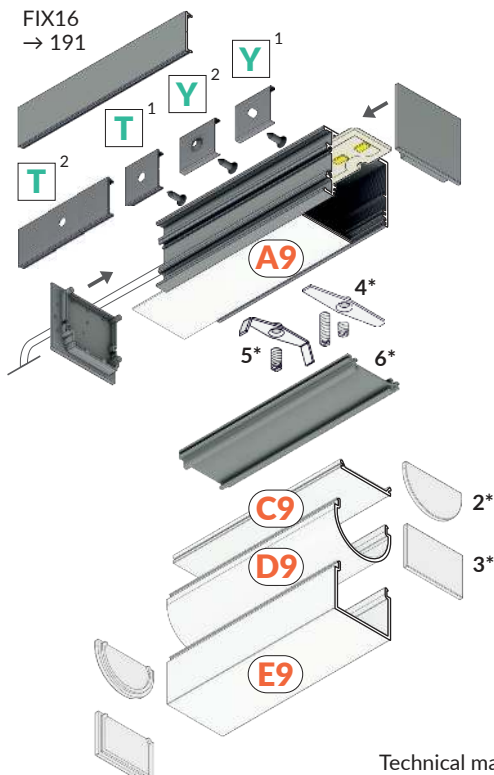
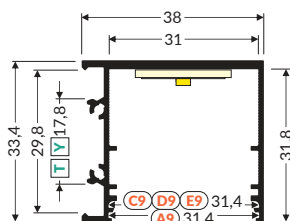

Technical manual
Instrukcja techniczna
Technische Anleitung
Manuel technique



more information



więcej szczegółów



Y¹ → 208

mounting plate Y
uchwyt Y
Halter Y
fixation Y

Y² → 208

mounting plate Y cone
uchwyt Y cone
Halter Y cone
fixation Y cône

T¹ → 204

mounting plate T
uchwyt T
Halter T
fixation T

T² → 204

connector T 180 deg
łącznik T 180 st
Verbinder T 180 Grad
connecteur T 180 degrés

A9 → 194

diffuser A9 slide
klosz A9 wsuwany
Abdeckung A9 einziehbar
diffuseur A9 coulissant

C9 → 197

diffuser C9 click
klosz C9 klik
Abdeckung C9 einclipsbar
diffuseur C9 clic

D9 → 198

diffuser D9 click
klosz D9 klik
Abdeckung D9 einclipsbar
diffuseur D9 clic

E9 → 199

diffuser E9 click
klosz E9 klik
Abdeckung E9 einclipsbar
diffuseur E9 clic



white painted
biały malowany
weiß lackiert
peint en blanc



anodized
anodowany
eloxiert
surface anodisée



black anodized
czarny anodowany
schwarz eloxiert
noir anodisé



raw aluminium
surowe aluminium
Rohaluminium
aluminium brut

1000 mm	V3090001	V3090020	V3090021	V3090000
2000 mm	V3100001	V3100020	V3100021	V3100000
3000 mm	V3110001	V3110020	V3110021	V3110000
4050 mm	V3120001	V3120020	V3120021	V3120000

end cap VARIO30-03
zaślepka VARIO30-03
Endkappe VARIO30-03
embout VARIO30-03

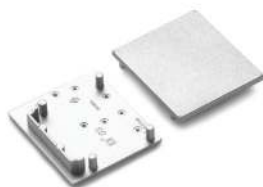

white	silver
biały	srebrny
weiß	silbern
blanc	argent
V4890001	V4890040
black	grey
czarny	szary
schwarz	grau
noir	gris
V4890002	V4890022

connector VARIO30-0203 180 deg
łącznik VARIO30-0203 180 st
Verbinder VARIO30-0203 180 Grad
connecteur VARIO30-0203 180 degrés

material: aluminium, polycarbonate
materiał: aluminium, poliwęglan
Material: Aluminium, Polycarbonat
matériel: aluminium, polycarbonate

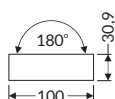

V4640000s

2* → 198

end cap D9
zaślepka D9
Endkappe D9
embout D9

3* → 199

end cap E9
zaślepka E9
Endkappe E9
embout E9

4* → 210

LED clamp VARIO30
docisk LED VARIO30
LED Klemme VARIO30
clip de fixation LED VARIO30

5* → 210

LED clamp VARIO30-1
docisk LED VARIO30-1
LED Klemme VARIO30-1
clip de fixation LED VARIO30 1

6* → 210

LED mounting VARIO30
mocowanie LED VARIO30
LED Montageteil VARIO30
barre de fixation LED VARIO30

ASSISTANT PROFILES

PROFILE POMOCNICZE

HILFSPROFILE

PROFILÉS AUXILIAIRES

VARIO30-08

power supply profile
profil zasilający
Einspeisungsprofil
profilé d'alimentation

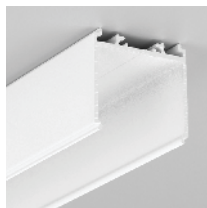
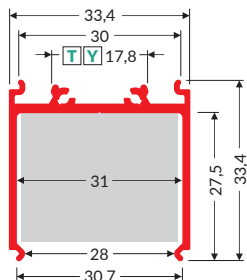

white painted
biały malowany
weiß lackiert
peint en blanc



anodized
anodowany
eloxiert
surface anodisée



black anodized
czarny anodowany
schwarz eloxiert
noir anodisé



raw aluminium
surowe aluminium
Rohaluminium
aluminium brut

1000 mm	V3290001	V3290020	V3290021	V3290000
2000 mm	V3300001	V3300020	V3300021	V3300000
3000 mm	V3310001	V3310020	V3310021	V3310000
4050 mm	V3320001	V3320020	V3320021	V3320000

VARIO30-09

cover
osłona
Abdeckplatte
cache

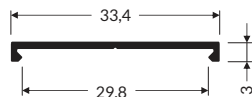

white painted
biały malowany
weiß lackiert
peint en blanc



anodized
anodowany
eloxiert
surface anodisée



black anodized
czarny anodowany
schwarz eloxiert
noir anodisé



raw aluminium
surowe aluminium
Rohaluminium
aluminium brut

1000 mm	V3330001	V3330020	V3330021	V3330000
2000 mm	V3340001	V3340020	V3340021	V3340000
3000 mm	V3350001	V3350020	V3350021	V3350000
4050 mm	V3360001	V3360020	V3360021	V3360000

LED profile FIX16
profil LED FIX16
Profil LED FIX16
profilé LED FIX16

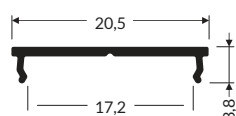

white painted
biały malowany
weiß lackiert
peint en blanc



anodized
anodowany
eloxiert
surface anodisée



black anodized
czarny anodowany
schwarz eloxiert
noir anodisé



raw aluminium
surowe aluminium
Rohaluminium
aluminium brut

1000 mm	C6010001	C6010020	C6010021	C6010000
2000 mm	C6020001	C6020020	C6020021	C6020000
3000 mm	C6030001	C6030020	C6030021	C6030000
4050 mm	C6040001	C6040020	C6040021	C6040000

PROMOTED VARIANTS WITH POWER SUPPLY DIFFUSER
 PROMOWANE WARIANTY Z OSŁONĄ ZASILACZA
 EMPFOHLENE VARIANTEN MIT SPEISELEITUNGSSCHUTZ
 VARIANTES RECOMMANDEES AVEC ALIMENTATION INTEGREE

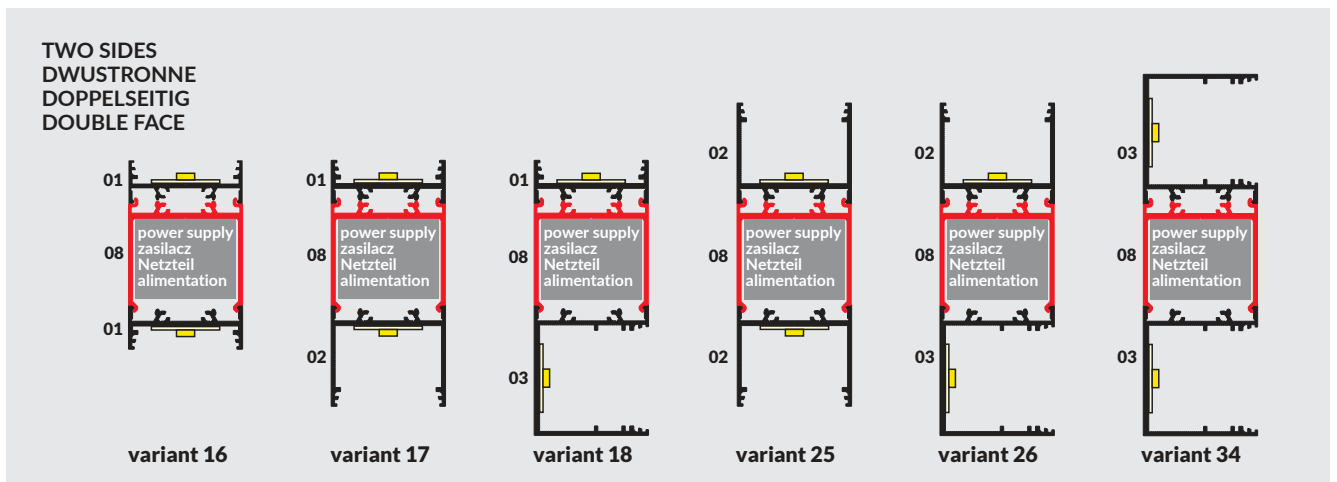
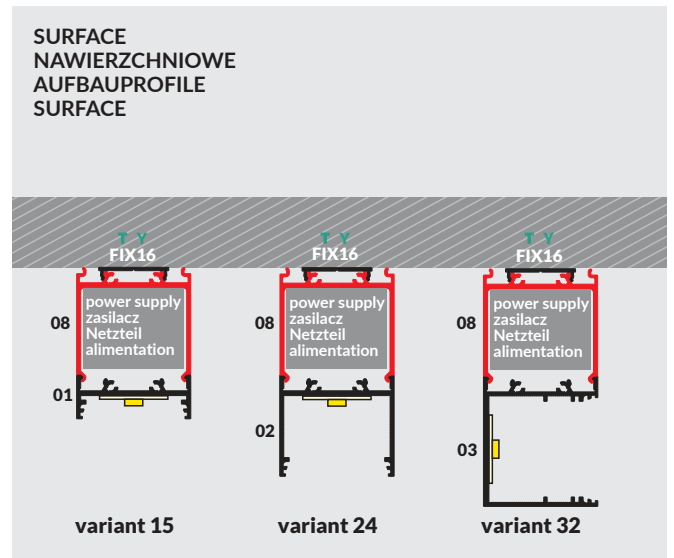
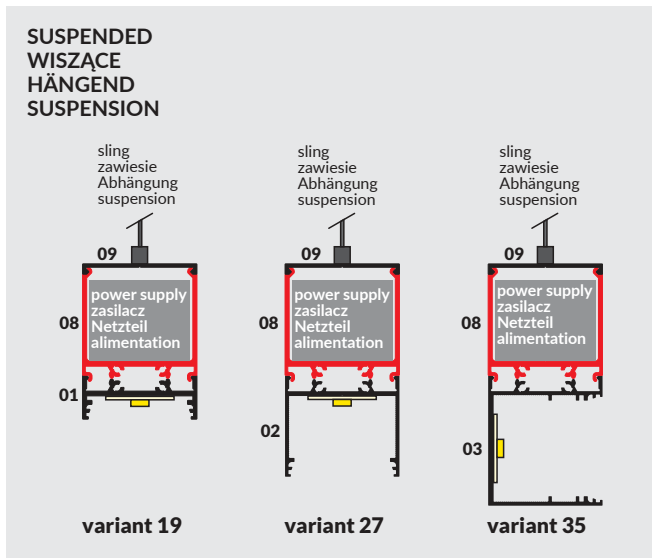

END CAPS KNOW HOW OZNACZENIA ZAŚLEPEK BEZEICHNUNGEN DER ENDKAPPEN MARQUAGE DES EMBOUTS

diffuser / cover / profile
klosz / osłona / profil
Abdeckung / Abdeckplatte / Profil
diffuseur / cache / profilé

names of profiles fitting with chosen end cap:
nazwy profili pasujących do wybranej zaślepki:
Die Namen der Profile, die mit einer gewählten Endkappe
zusammenpassen:
noms des profilés correspondant au embout sélectionné :
- VARIO30-09

end cap dedicated to VARIO30-08 profile
zaślepka dedykowana do profilu 08
die für das Profil 08 vorgesehene Endkappe
embout pour profilé 08

bottom of the LED profile
dół profilu LED
der untere Teil des LED Profils
bas du profilé LED

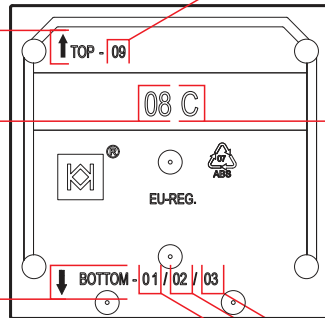

type of variant
typ wariantu
Variantentyp
type de variante

names of profiles fitting with chosen end cap:
nazwy profili pasujących do wybranej zaślepki:
Namen der Profile, die für eine gewählte
Endkappe passen:
noms des profilés correspondant au bouchon
sélectionné :
- VARIO30-01
- VARIO30-02
- VARIO30-03

an example
przykład
Beispiel
exemple

VARIANT 18

end cap
zaślepka
Endkappe
embout
VARIO30-01

end cap
zaślepka
Endkappe
embout
VARIO30-08D

end cap
zaślepka
Endkappe
embout
VARIO30-03

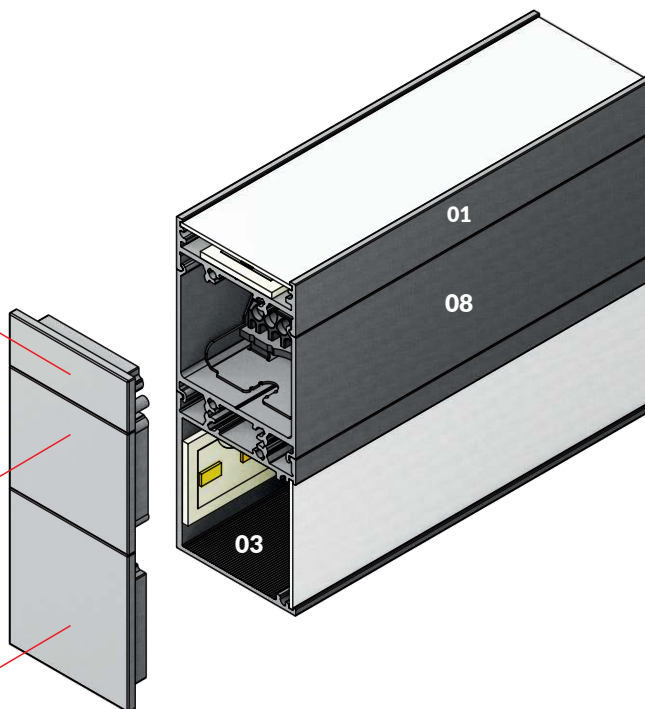

end cap
zaślepka
Endkappe
embout
VARIO30-01

end cap
zaślepka
Endkappe
embout
VARIO30-08D

end cap
zaślepka
Endkappe
embout
VARIO30-03

08 END CAPS material: ABS
ZAŚLEPKI 08 materiał: ABS
ENDKAPPEN 08 material: ABS
EMBOUT 08 matériel: ABS

end cap VARIO30-08A
 zaślepka VARIO30-08A
 Endkappe VARIO30-08A
 EMBOUT 08 matériel: ABS

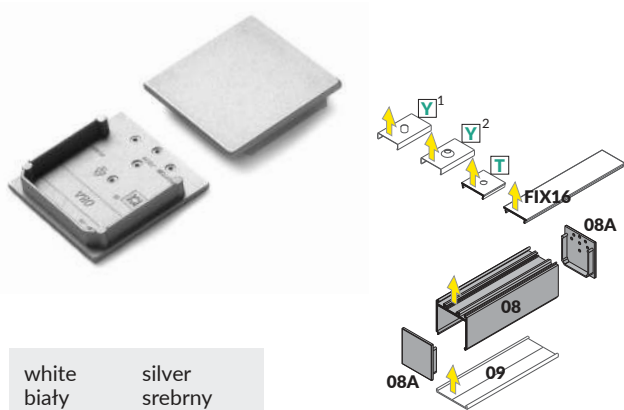

white	silver
biały	srebrny
weiß	silbern
blanc	argent
V4940001	V4940040
black	grey
czarny	szary
schwarz	grau
noir	gris
V4940002	V4940022

end cap VARIO30-08B For variants: 15, 24, 32
 zaślepka VARIO30-08B Dla wariantów: 15, 24, 32
 Endkappe VARIO30-08B Für Varianten: 15, 24, 32
 embout VARIO30-08B Pour les variantes: 15, 24, 32

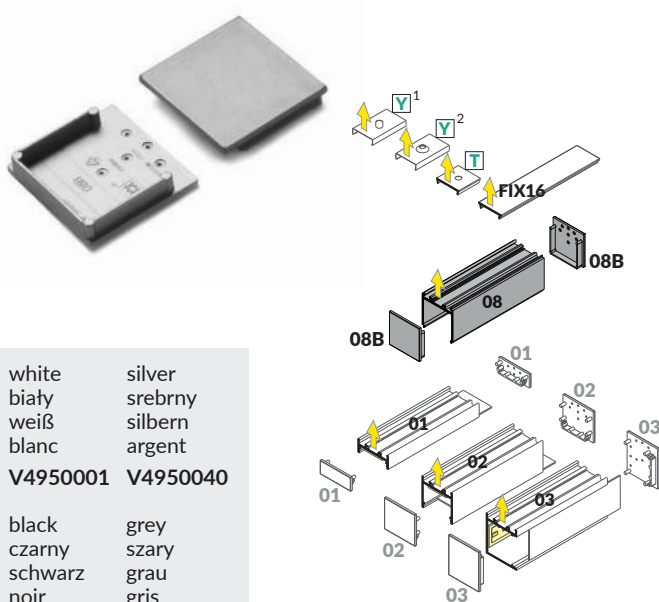

white	silver
biały	srebrny
weiß	silbern
blanc	argent
V4950001	V4950040
black	grey
czarny	szary
schwarz	grau
noir	gris
V4950002	V4950022

end cap VARIO30-08C For variants: 19, 27, 35
 zaślepka VARIO30-08C Dla wariantów: 19, 27, 35
 Endkappe VARIO30-08C Für Varianten: 19, 27, 35
 embout VARIO30-08C Pour les variantes: 19, 27, 35

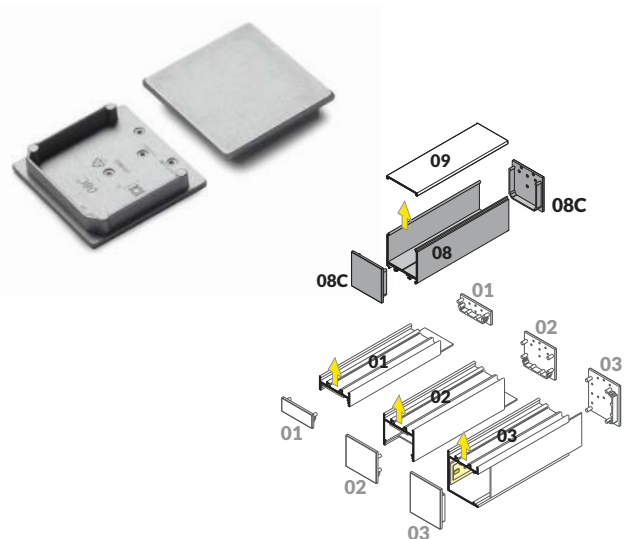

white	silver
biały	srebrny
weiß	silbern
blanc	argent
V4960001	V4960040
black	grey
czarny	szary
schwarz	grau
noir	gris
V4960002	V4960022

end cap VARIO30-08D For variants: 16, 17, 18, 25, 26, 34
 zaślepka VARIO30-08D Dla wariantów: 16, 17, 18, 25, 26, 34
 Endkappe VARIO30-08D Für Varianten: 16, 17, 18, 25, 26, 34
 embout VARIO30-08D Pour les variantes: 16, 17, 18, 25, 26, 34

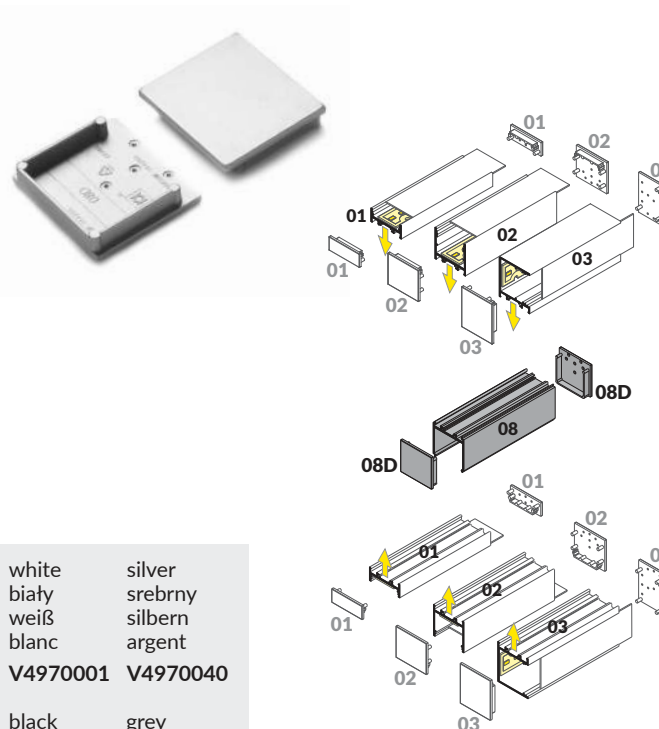

white	silver
biały	srebrny
weiß	silbern
blanc	argent
V4970001	V4970040
black	grey
czarny	szary
schwarz	grau
noir	gris
V4970002	V4970022

METAL END CAPS MATERIAL: STEEL

ZASLEPKI METALOWE MATERIAŁ: STAL

METALLENDKAPPEN MATERIAL: STAHL

EMBOUTS MÉTALLIQUES MATÉRIEL: ACIER

end cap VARIO30-16-E9 metal
zaślepka VARIO30-16-E9 metal
Endkappe VARIO30-16-E9 Metall
embout VARIO30-16-E9 acier

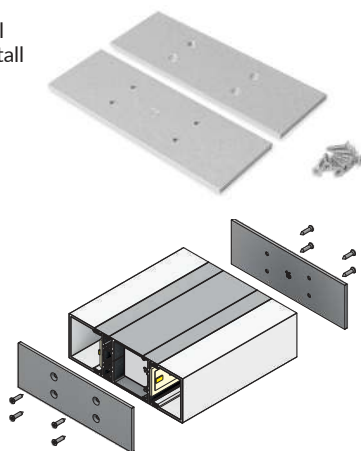

white biały weiß blanc	silver srebrny silbern argent
V4550001S	V4550022S
black czarny schwarz noir	
V4550002S	

end cap VARIO30-19-E9 metal
zaślepka VARIO30-19-E9 metal
Endkappe VARIO30-19-E9 Metall
embout VARIO30-19-E9 metal

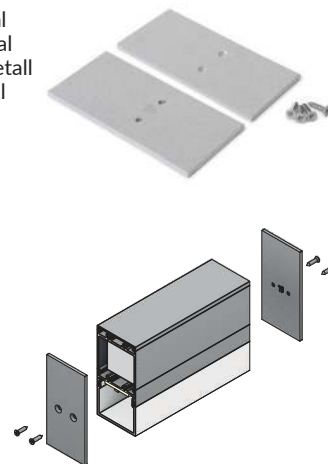

white biały weiß blanc	silver srebrny silbern argent
V4560001S	V4560022S
black czarny schwarz noir	
V4560002S	

end cap VARIO30-27 metal
zaślepka VARIO30-27 metal
Endkappe VARIO30-27 Metall
embout VARIO30-27 metal

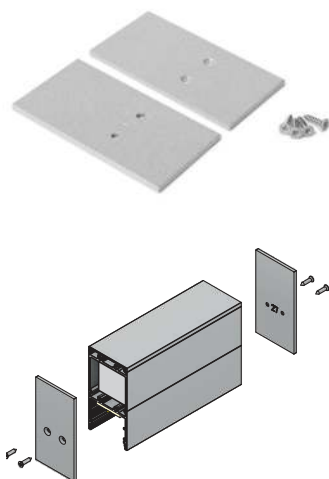

white biały weiß blanc	silver srebrny silbern argent
V4570001S	V4570022S
black czarny schwarz noir	
V4570002S	

end cap VARIO30-32 metal
zaślepka VARIO30-32 metal
Endkappe VARIO30-32 Metall
embout VARIO30-32 metal

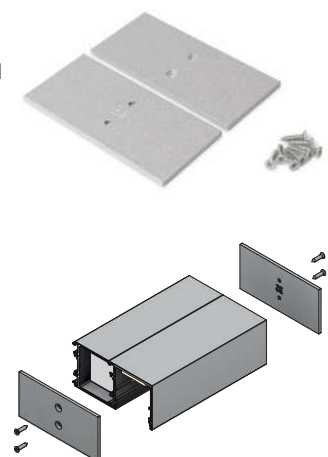

white biały weiß blanc	silver srebrny silbern argent
V4580001S	V4580022S
black czarny schwarz noir	
V4580002S	

end cap VARIO30-34 metal
zaślepka VARIO30-34 metal
Endkappe VARIO30-34 Metall
embout VARIO30-34 metal

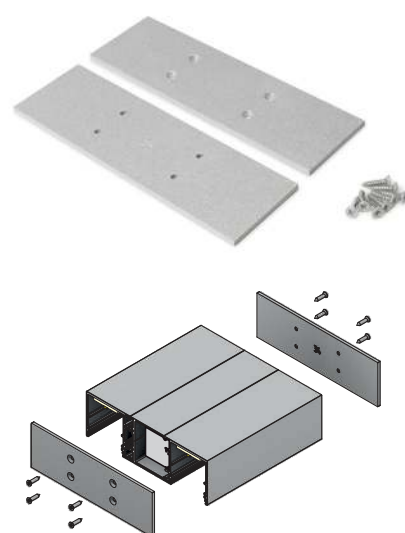

white biały weiß blanc	silver srebrny silbern argent
V4590001S	V4590022S
black czarny schwarz noir	
V4590002S	



COMBO30



max 30 mm

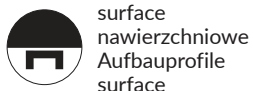

surface
nawierzchniowe
Aufbauprofile
surface



suspended
zwieszane
hängend
suspendu

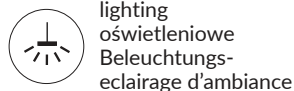

lighting
oświetleniowe
Beleuchtungs-
éclairage d'ambiance

- multi-armed connections
- simplified installation and service
- for the construction of suspended and surface luminaires
- optional up&down lighting

- wieloramienne połączenia
- ułatwiony montaż i serwis
- do budowy opraw wiszących i powierzchniowych
- opcja świecenia góra/dół

- mehrarmige Verbindungen
- leichtere Montage und Service
- für den Bau von Hänge- und Aufbauleuchten
- optionale Up&Down-Beleuchtung

- connexions multibras
- montage et entretien plus faciles
- pour la construction de luminaires suspendus et de surface
- éclairage haut et bas en option



more
information



więcej
szczegółów

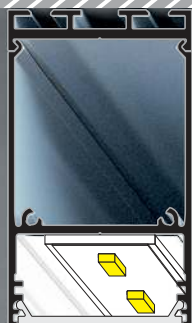

COMBO30-01 ACDE-9

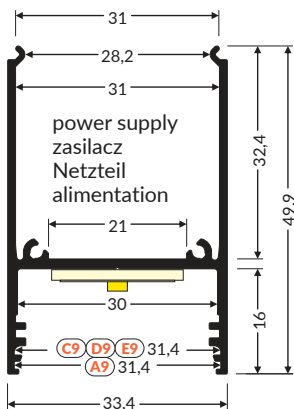

sling
zawiesie
Abhängung
suspension
→ 209

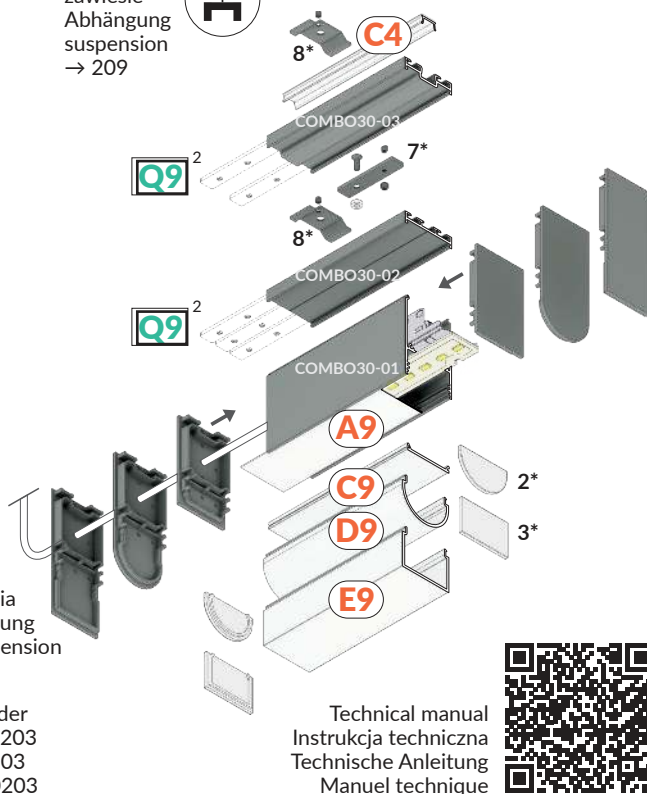

- 2* → 198** end cap D9
zaślepka D9
Endkappe D9
embout D9
- 3* → 199** end cap E9
zaślepka E9
Endkappe E9
embout E9
- 7* → 203** holder Q9 for sling
uchwyt Q9 do zawiesia
Halter Q9 für Abhängung
fixation Q9 pour suspension
- 8* → 73** COMBO30-0203 holder
uchwyt COMBO30-0203
Halter COMBO30-0203
fixation COMBO30-0203

Technical manual
Instrukcja techniczna
Technische Anleitung
Manuel technique



- C4 → 196** diffuser C4 click
klosz C4 klik
Abdeckung C4 einclipsbar
diffuseur C4 clic
- Q9¹ → 203** connector Q9 90 deg bent
łącznik Q9 90 st gięty
Verbinder Q9 90 Grad gebogen
connecteur Q9 90 degrés suspendus
- Q9² → 203** connector Q9 180 deg
łącznik Q9 180 st
Verbinder Q9 180 Grad
connecteur Q9 180 degrés
- Q9³ → 203** connector Q9 135 deg
łącznik Q9 135 st
Verbinder Q9 135 Grad
connecteur Q9 135 degrés
- Q9⁴ → 203** connector Q9 120 deg
łącznik Q9 120 st
Verbinder Q9 120 Grad
connecteur Q9 120 degrés
- Q9⁵ → 203** connector Q9 90 deg
łącznik Q9 90 st
Verbinder Q9 90 Grad
connecteur Q9 90 degrés

white painted biały malowany weiß lackiert peint en blanc	anodized anodowany eloxiert surface anodisée	black anodized czarny anodowany schwarz eloxiert noir anodisé	raw aluminium surowe aluminium Rohaluminium aluminium brut
1000 mm V6000101	V6000120	V6000121	V6000100
2000 mm V6000201	V6000220	V6000221	V6000200
3000 mm V6000301	V6000320	V6000321	V6000300
4050 mm V6000401	V6000420	V6000421	V6000400

- Q9⁶ → 203** connector Q9 60 deg
łącznik Q9 60 st
Verbinder Q9 60 Grad
connecteur Q9 60 degrés
- Q9⁷ → 203** connector Q9 45 deg
łącznik Q9 45 st
Verbinder Q9 45 Grad
connecteur Q9 45 degrés

- A9 → 194** diffuser A9 slide
klosz A9 wsuwany
Abdeckung A9 einschiebbar
diffuseur A9 coulissant

end cap COMBO30-01A
zaślepka COMBO30-01A
Endkappe COMBO30-01A
embout COMBO30-01A

end cap COMBO30-01A-D9
zaślepka COMBO30-01A-D9
Endkappe COMBO30-01A-D9
embout COMBO30-01A-D9

end cap COMBO30-01A-E9
zaślepka COMBO30-01A-E9
Endkappe COMBO30-01A-E9
embout COMBO30-01A-E9



- white
biały
weiß
blanc
V6998901
- silver
srebrny
silbern
argent
V6998940
- black
czarny
schwarz
noir
V6998902
- grey
szary
grau
gris
V6998922

- white
biały
weiß
blanc
V6999001
- silver
srebrny
silbern
argent
V6999040
- black
czarny
schwarz
noir
V6999002
- grey
szary
grau
gris
V6999022

- white
biały
weiß
blanc
V6999101
- silver
srebrny
silbern
argent
V6999140
- black
czarny
schwarz
noir
V6999102
- grey
szary
grau
gris
V6999122

- C9 → 197** diffuser C9 click
klosz C9 klik
Abdeckung C9 einclipsbar
diffuseur C9 clic
- D9 → 198** diffuser D9 click
klosz D9 klik
Abdeckung D9 einclipsbar
diffuseur D9 clic
- E9 → 199** diffuser E9 click
klosz E9 klik
Abdeckung E9 einclipsbar
diffuseur E9 clic

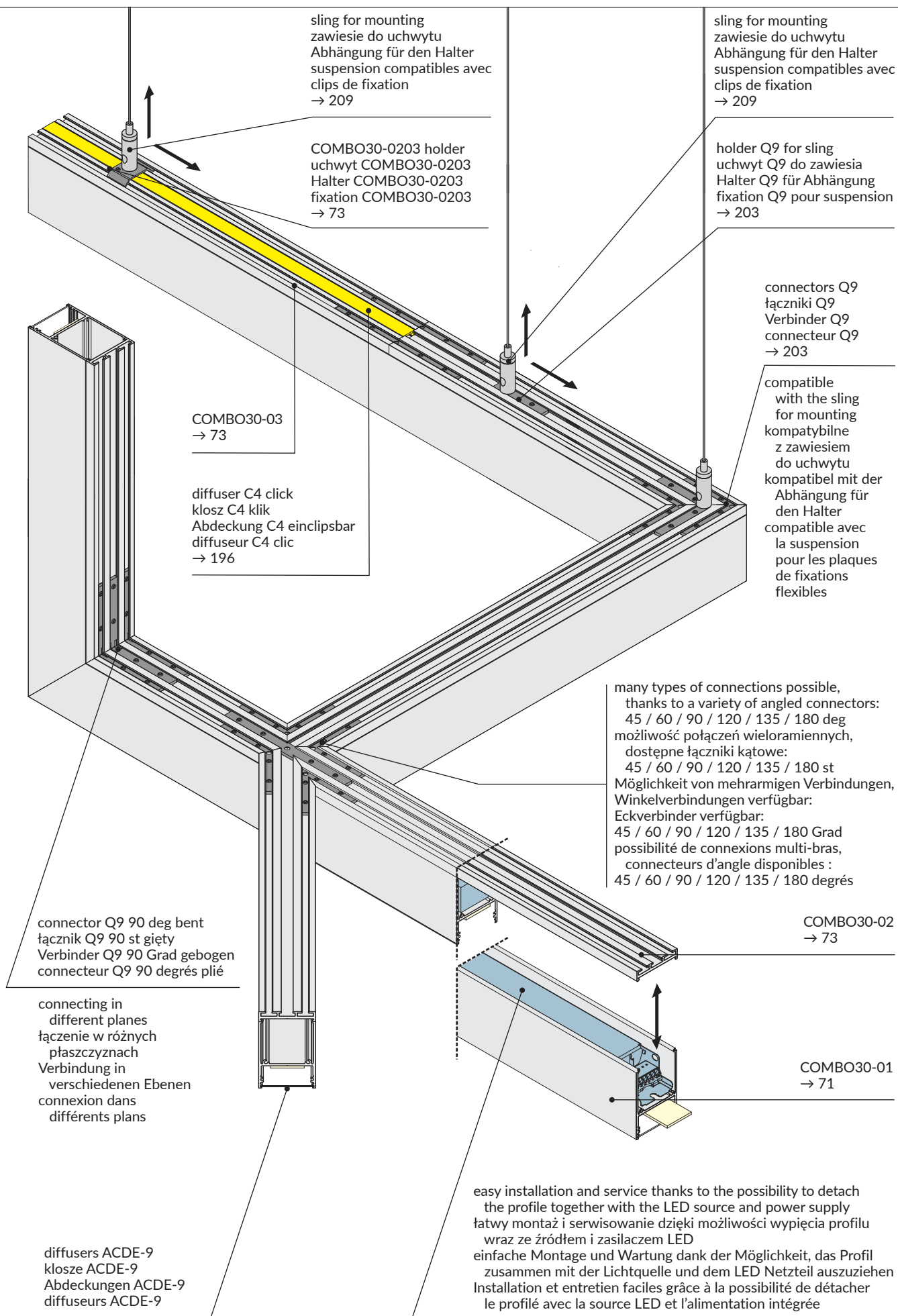

COMPLEMENTARY PROFILE COMBO30-02
 PROFIL UZUPEŁNIAJĄCY COMBO30-02
 ERGÄNZUNGSPROFIL COMBO30-02
 PROFILÉ COMPLÉMENTAIRE COMBO30-02

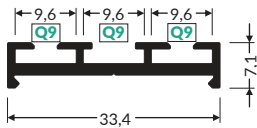

white painted
biały malowany
weiß lackiert
peint en blanc



anodized
anodowany
eloxiert
surface anodisée



black anodized
czarny anodowany
schwarz eloxiert
noir anodisé



raw aluminium
surowe aluminium
Rohaluminium
aluminium brut

1000 mm	V6000501	V6000520	V6000521	V6000500
2000 mm	V6000601	V6000620	V6000621	V6000600
3000 mm	V6000701	V6000720	V6000721	V6000700
4050 mm	V6000801	V6000820	V6000821	V6000800

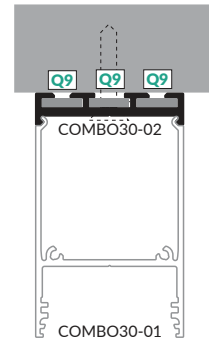
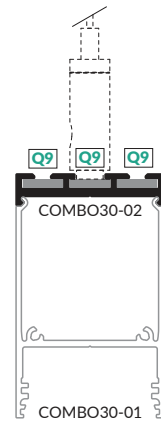

COMPLEMENTARY PROFILE COMBO30-03
 PROFIL UZUPEŁNIAJĄCY COMBO30-03
 ERGÄNZUNGSPROFIL COMBO30-03
 PROFILÉ COMPLÉMENTAIRE COMBO30-03

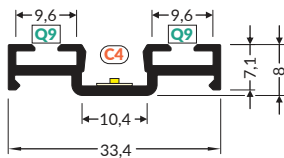

white painted
biały malowany
weiß lackiert
peint en blanc



anodized
anodowany
eloxiert
surface anodisée



black anodized
czarny anodowany
schwarz eloxiert
noir anodisé



raw aluminium
surowe aluminium
Rohaluminium
aluminium brut

1000 mm	V6000901	V6000920	V6000921	V6000900
2000 mm	V6001001	V6001020	V6001021	V6001000
3000 mm	V6001101	V6001120	V6001121	V6001100
4050 mm	V6001201	V6001220	V6001221	V6001200

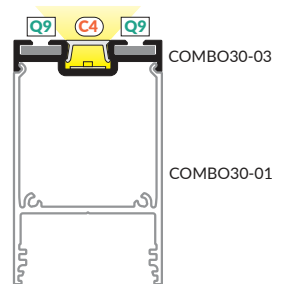
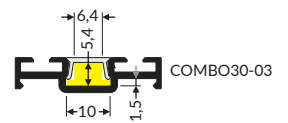

holder COMBO30-0203
 uchwyt COMBO30-0203
 Halter COMBO30-0203
 fixation COMBO30-0203

material: stainless steel
 materiał: stal nierdzewna
 Material: rostfreier Stahl
 matériel: acier inoxydable

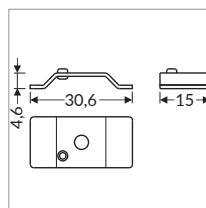

inox
V5998719

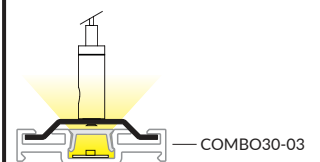
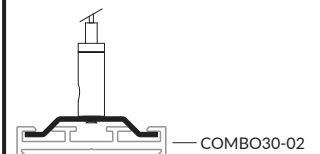

MANY OPTIONS OF ANGULAR CONNECTIONS WIELE MOŻLIWOŚCI POŁĄCZEŃ KĄTOWYCH VIELE MÖGLICHKEITEN DER ECKVERBINDUNGEN DE NOMBREUSES POSSIBILITÉS DE CONNEXIONS ANGULAIRES



The system of connectors and sockets in the profile allows the creation of stable multi-armed connections and the use of slings in the place of profile connections
System łączników i gniazd w profilu pozwala na tworzenie stabilnych połączeń wieloramiennych oraz na użycie zawieszki w miejscu łączenia profili
Das System von Verbindungen und Sockeln im Profil ermöglicht die Schaffung stabiler mehrarmiger Verbindungen und die Verwendung von Abhängung an der Stelle der Profilverbindung
Le système de connecteurs et de prises dans le profilé permet la création de connexions multi-bras stables et l'utilisation d'un kit de suspensions dans les endroits de connexion des profilés

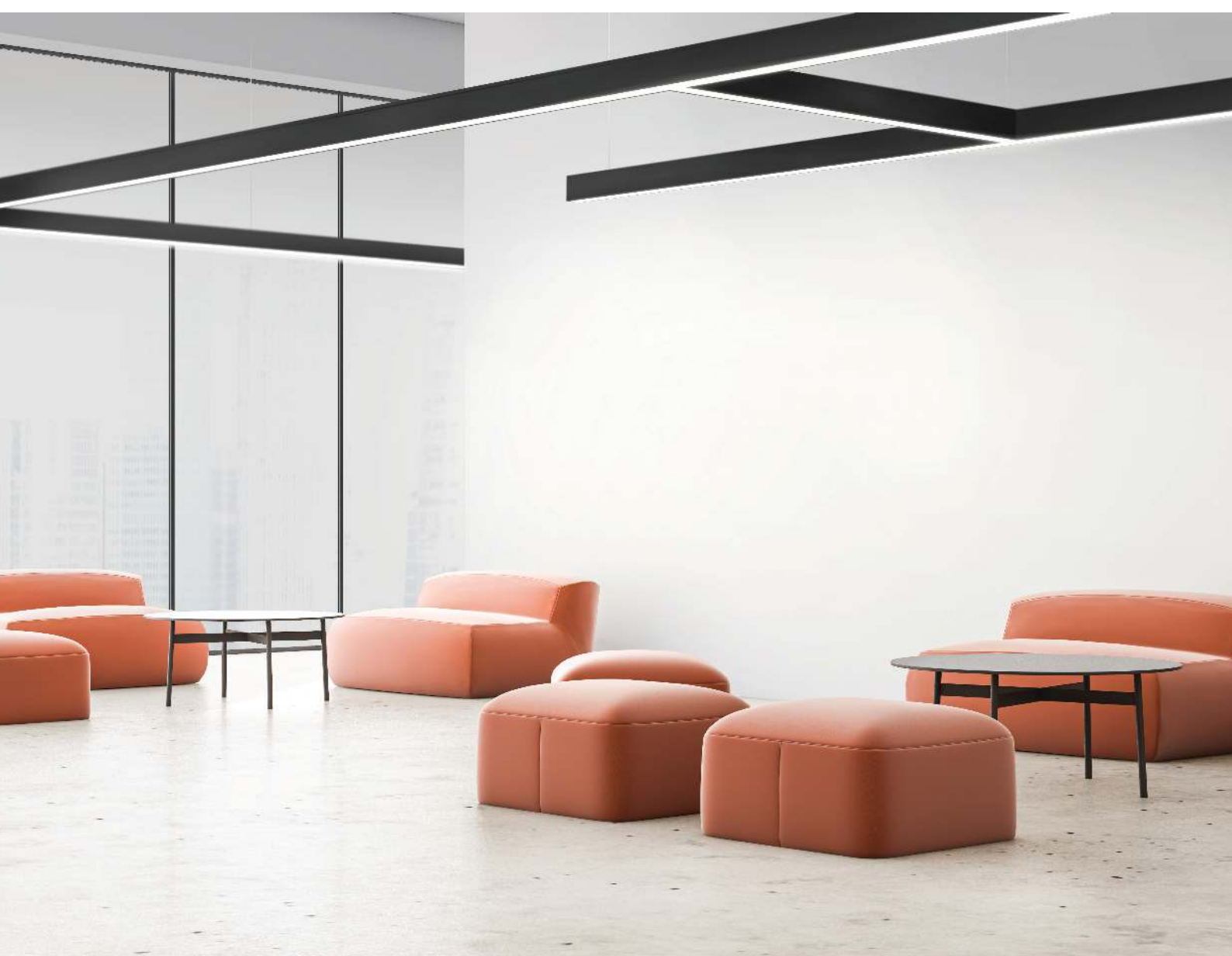

Connectors used in the example:
Łączniki użyte w przykładzie:
Die im Beispiel verwendeten Verbindungen:
Connecteurs utilisés dans l'exemple:

connector Q9 135 deg
łącznik Q9 135 st
Verbinder Q9 135 Grad
connecteur Q9 135 degrés

connector Q9 45 deg
łącznik Q9 45 st
Verbinder Q9 45 Grad
connecteur Q9 45 degrés

connector Q9 180 deg (x2)
łącznik Q9 180 st (x2)
Verbinder Q9 180 Grad (x2)
connecteur Q9 1805 degrés (x2)

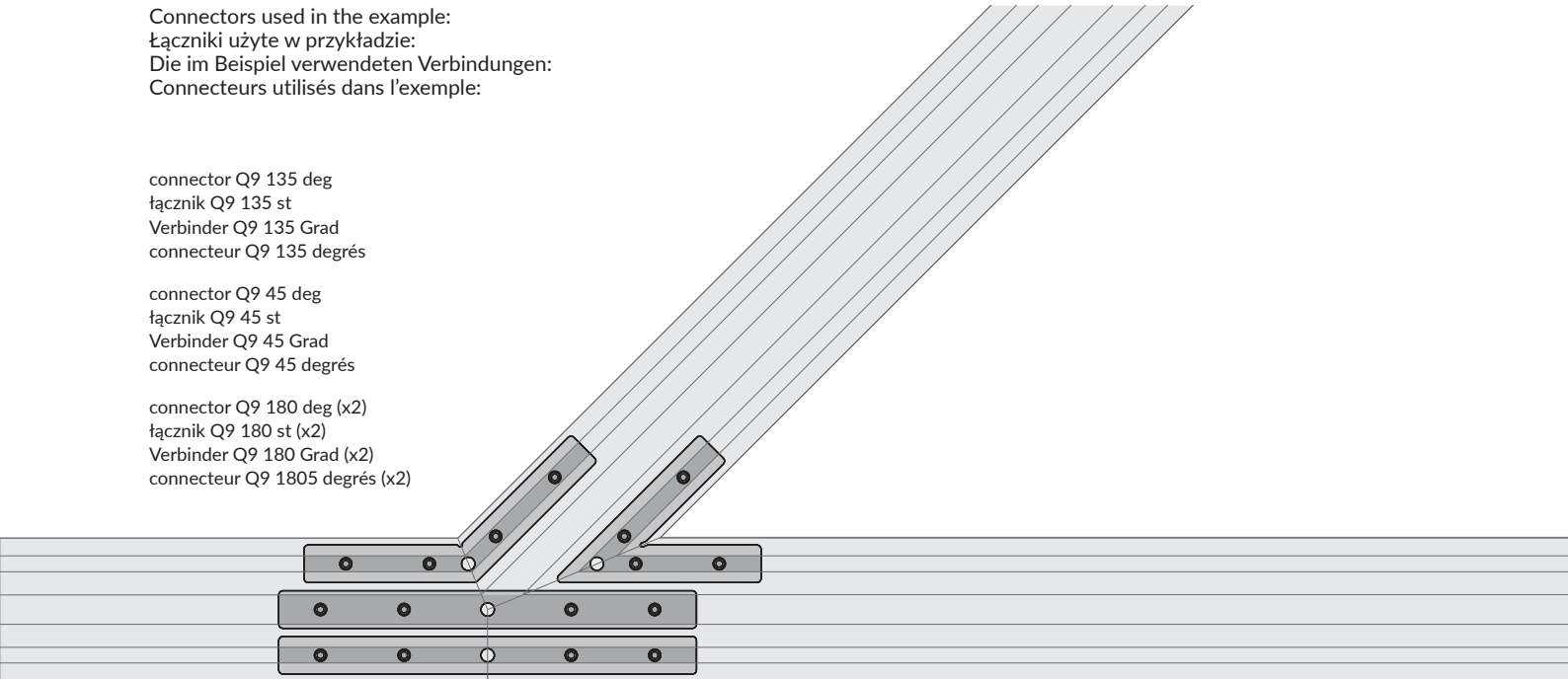

NAMI23 CD-9



max 23 mm



suspended
zwieszane
hängend
suspendu



lighting
oświetleniowe
Beleuchtungs-
éclairage d'ambiance

- for the construction of suspended LED luminaires
- unique aesthetics, new design
- minimalist and refined details
- convenient mounting and service – clip-on profile for LED source
- space for the power supply inside the luminaire
- designed for painting

- do budowy wiszących opraw LED
- wyjątkowa estetyka, świeże wzornictwo
- minimalistyczne i dopracowane detale
- wygodny montaż i serwis – wkłikiwany profil na źródło LED
- miejsce na zasilacz wewnątrz oprawy
- przeznaczony pod malowanie

- für den Bau der hängenden LED Leuchten
- einmalige Ästhetik, frisches Design
- minimalistische und auserlesene Details
- bequeme Montage und Service - einklickbares Profil für LED-Lichtquelle
- Platz für Speiseleitung innerhalb der Leuchte
- bestimmt fürs Anstreichen

- pour construction des luminaires LED suspendus
- esthétique unique, design frais
- détails minimalistes et raffinés
- installation et service pratiques – profil à cliquer pour la source LED
- espace pour intégrer alimentation à l'intérieur du luminaire
- destiné à la peinture



more
information

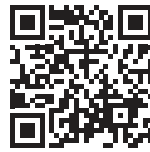

więcej
szczegółów



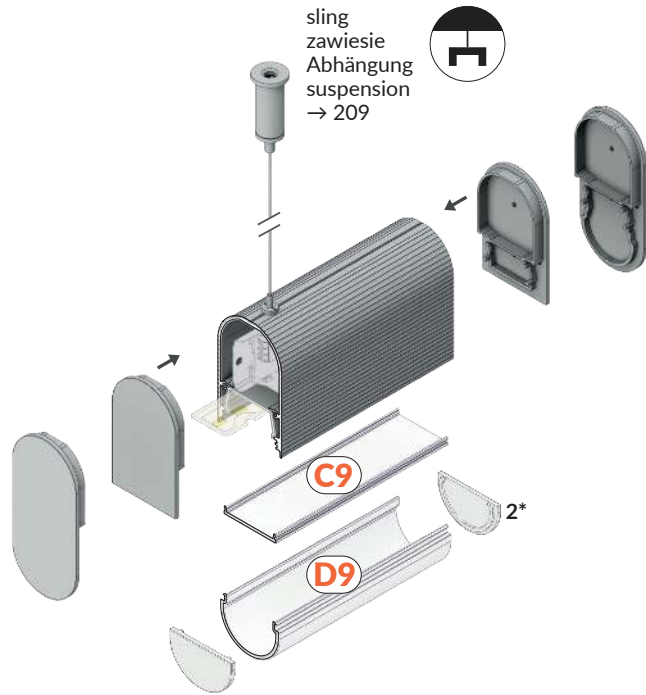
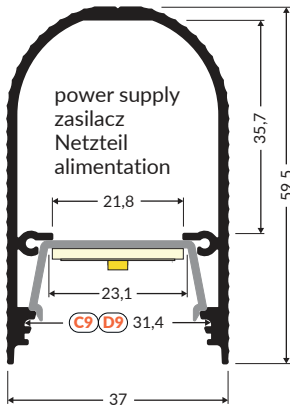

C9 → 197

diffuser C9 click
klosz C9 klik
Abdeckung C9 einclipsbar
diffuseur C9 clic

D9 → 198

diffuser D9 click
klosz D9 klik
Abdeckung D9 einclipsbar
diffuseur D9 clic

2* → 198

end cap D9
zaślepka D9
Endkappe D9
embout D9

LED profile NAMI23
profil LED NAMI23
LED profile NAMI23
profilé LED NAMI23

complementary profile NAMI23
profil uzupełniający NAMI23
Ergänzungsprofil NAMI23
profilé complémentaire NAMI23



raw aluminium
surowe aluminium
Rohaluminium
aluminium brut



anodized
anodowany
eloxiert
surface anodisée

1000 mm	K1000100	K1000520
2000 mm	K1000200	K1000620
3000 mm	K1000300	K1000720
4050 mm	K1000400	K1000820

end cap NAMI23
zaślepka NAMI23
Endkappe NAMI23
embout NAMI23



grey
szary
grau
gris
K1999822

end cap NAMI23-D9
zaślepka NAMI23-D9
Endkappe NAMI23-D9
embout NAMI23-D9



grey
szary
grau
gris
K1999922

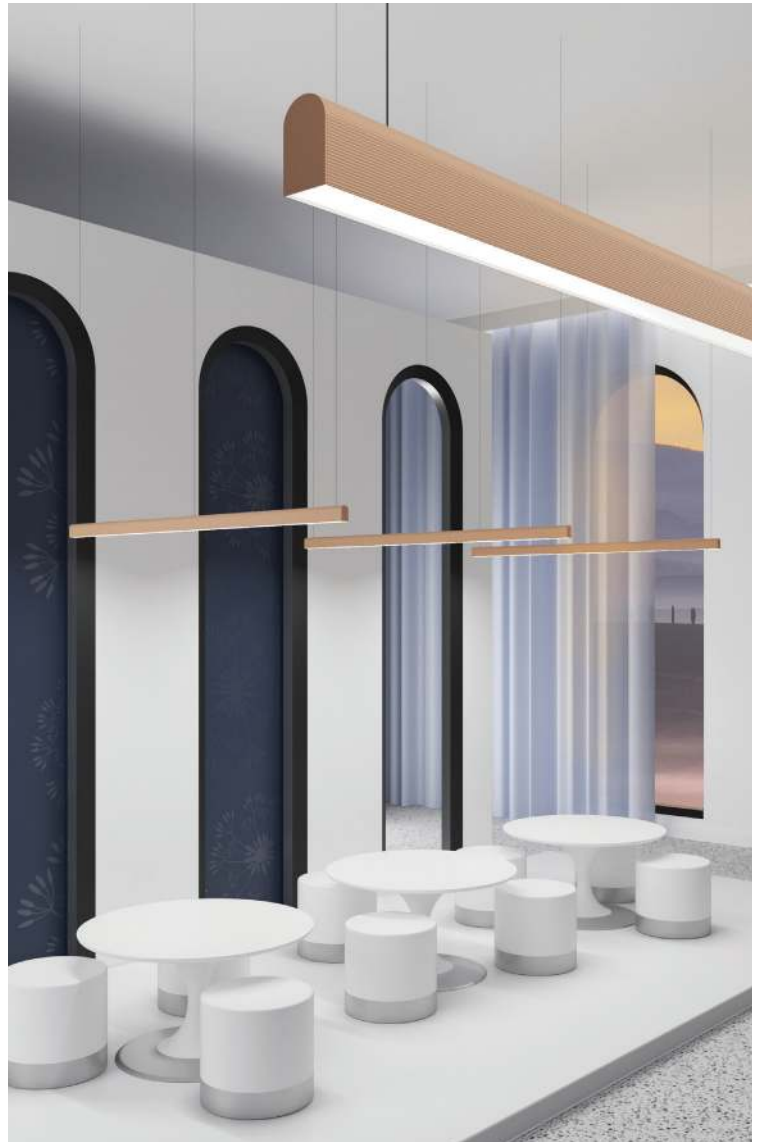

LOWI C10



max 42 mm



surface
nawierzchniowe
Aufbauprofile
surface



suspended
zwieszane
hängend
suspendu



lighting
oświetleniowe
Beleuchtungs-
éclairage d'ambiance

- profile for creating LED luminaires
- perfect as main lighting
- 3 types of covers available with different light distributions

- profil do tworzenia opraw oświetleniowych
- doskonały jako oświetlenie główne
- dostępne 3 rodzaje kloszy o różnych rozsyłach światła

- Profile für die Erstellung von LED-Leuchten
- perfekt als Hauptbeleuchtung
- 3 Arten von Abdeckungen mit unterschiedlichen Lichtverteilungen verfügbar

- les profilés pour la création de luminaires LED
- un éclairage principal optimal
- 3 types de diffuseurs sont proposés avec des répartitions de la lumière différentes



more
information



więcej
szczegółów

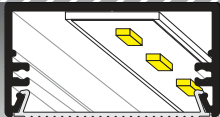

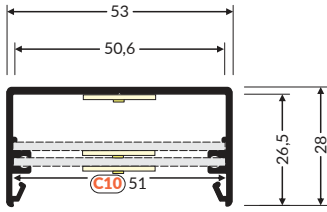

sling
zawiesz
Abhängung
suspension
→ 209

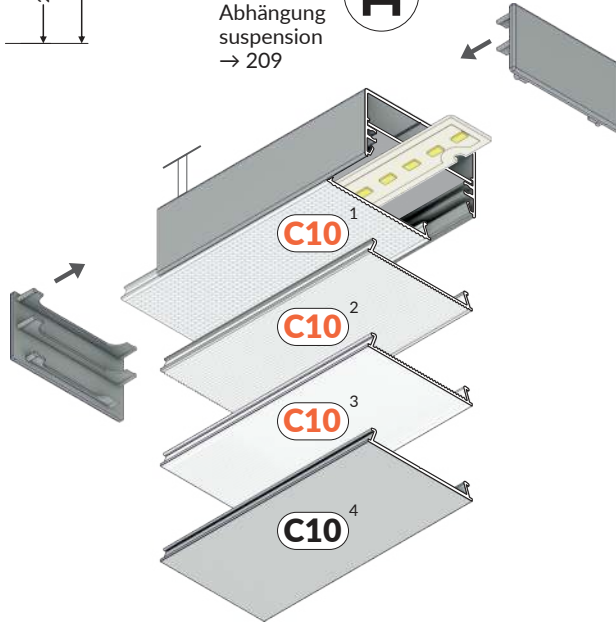

C10¹ → 197

diffuser C10 click OPAL
klosz C10 klik OPAL
Abdeckung C10
einclipsbar OPAL
diffuseur C10 clic OPAL

C10² → 197

diffuser C10 click NARROW
klosz C10 klik NARROW
Abdeckung C10
einclipsbar NARROW
diffuseur C10 clic NARROW

C10³ → 197

diffuser C10 click WIDE
klosz C10 klik WIDE
Abdeckung C10
einclipsbar WIDE
diffuseur C10 clic WIDE

end cap LOWI
zaślepka LOWI
Endkappe LOWI
embout LOWI



white biały weiß blanc	silver srebrny silbern argent
93066001	93070040
black czarny schwarz noir	grey szary grau gris
93070002	93070022



white painted
biały malowany
weiß lackiert
peint en blanc



anodized
anodowany
eloxiert
surface anodisée



black painted
czarny malowany
schwarz lackiert
peint en noir



raw aluminium
surowe aluminium
Rohaluminium
aluminium brut

1000 mm	93020001	93020020	93020002	93020000
2000 mm	93030001	93030020	93030002	93030000
3000 mm	93090001	93090020	93090002	93090000
4050 mm	93100001	93100020	93100002	93100000

C10⁴

cover C10
ośona C10
Abdeckplatte C10
cache C10



white painted
biały malowany
weiß lackiert
peint en blanc

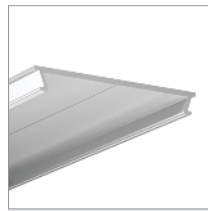

anodized
anodowany
eloxiert
surface anodisée



black painted
czarny malowany
schwarz lackiert
peint en noir



raw aluminium
surowe aluminium
Rohaluminium
aluminium brut

1000 mm	63550001	63550020	63550002	63550000
2000 mm	63560001	63560020	63560002	63560000
3000 mm	63740001	63740020	63740002	63740000
4050 mm	63750001	63750020	63750002	63750000

LED mounting 50
mocowanie LED 50
Montageteil LED 50
fixation LED 50

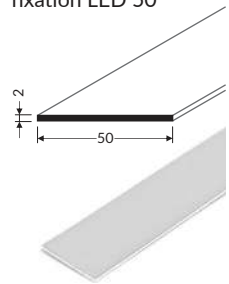

raw aluminium
surowe aluminium
Rohaluminium
aluminium brut

25080000
25090000
25170000
25180000

PHIL53 C10



max 46 mm



surface
nawierzchniowe
Aufbauprofile
surface



suspended
zwieszane
hängend
suspendu



lighting
oświetleniowe
Beleuchtungs-
éclairage d'ambiance

- profile for creating LED luminaires
- perfect as main lighting
- various installation options
- larger sizes
- 3 types of covers available with different light distributions
- enables hiding the power supply inside the profile

- profil do tworzenia opraw LED
- doskonały jako oświetlenie główne
- różnorodne opcje montażu
- większe gabaryty
- dostępne 3 rodzaje kloszy o różnych rozsyłach światła
- umożliwia ukrycie zasilacza wewnątrz profilu

- Profile für die Erstellung von LED Leuchten
- perfekt als Hauptbeleuchtung
- verschiedene Montageoptionen
- größere Baumasse
- 3 Arten von Abdeckungen mit unterschiedlichen Lichtverteilungen verfügbar
- ermöglicht das Verstecken des Netzteils innerhalb des Profils

- le profilé pour la création de luminaires LED
- un éclairage principal optimal
- les différentes options de montage - de suspension à encastrer
- les plus grandes dimensions
- 3 types de diffuseurs sont proposés avec des répartitions de la lumière différentes
- nos produits permettent de dissimuler le bloc d'alimentation à l'intérieur du profilé



more
information



więcej
szczegółów

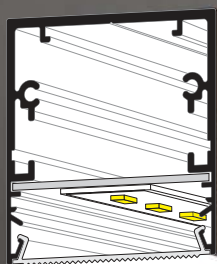

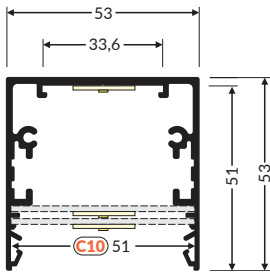

sling
zawiesz
Abhängung
suspension
→ 209

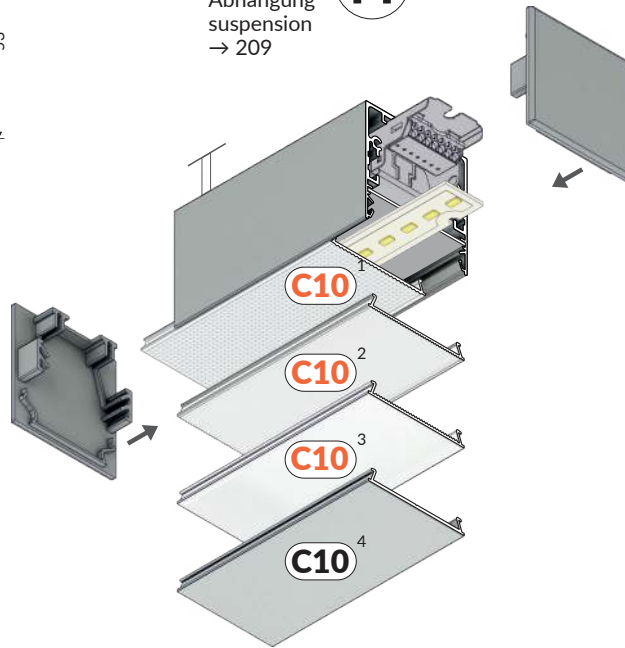

C10¹ → 197

diffuser C10 click OPAL
klosz C10 klik OPAL
Abdeckung C10
einclipsbar OPAL
diffuseur C10 clic OPAL

C10² → 197

diffuser C10 click NARROW
klosz C10 klik NARROW
Abdeckung C10
einclipsbar NARROW
diffuseur C10 clic NARROW

C10³ → 197

diffuser C10 click WIDE
klosz C10 klik WIDE
Abdeckung C10
einclipsbar WIDE
diffuseur C10 clic WIDE

end cap PHIL53
zaślepka PHIL53
Endkappe PHIL53
embout PHIL53



white painted
biały malowany
weiß lackiert
peint en blanc



anodized
anodowany
eloxiert
surface anodisée



black painted
czarny malowany
schwarz lackiert
peint en noir



raw aluminium
surowe aluminium
Rohaluminium
aluminium brut

1000 mm	63520001	63520020	63520002	63520000
2000 mm	63530001	63530020	63530002	63530000
3000 mm	63720001	63720020	63720002	63720000
4050 mm	63730001	63730020	63730002	63730000

white silver
biały srebrny
weiß silberny
blanc argent
63640001 **63640040**

black grey
czarny szary
schwarz grau
noir gris
63640002 **63640022**

C10⁴

cover C10
ośona C10
Abdeckplatte C10
cache C10



white painted
biały malowany
weiß lackiert
peint en blanc



anodized
anodowany
eloxiert
surface anodisée



black painted
czarny malowany
schwarz lackiert
peint en noir



raw aluminium
surowe aluminium
Rohaluminium
aluminium brut

1000 mm	63550001	63550020	63550002	63550000
2000 mm	63560001	63560020	63560002	63560000
3000 mm	63740001	63740020	63740002	63740000
4050 mm	63750001	63750020	63750002	63750000

LED mounting 50
mocowanie LED 50
Montageteil LED 50
fixation LED 50

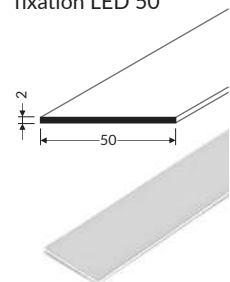

raw aluminium
surowe aluminium
Rohaluminium
aluminium brut

25080000
25090000
25170000
25180000



**RECESSED
WPUSTOWE
EINBAUPROFIL
A ENCASTRER**



SLASH8



max 8 mm



recessed
wpustowy
Einbauprofile
encastrés



furniture
meblowe
Möbel-
mobilier

- easy installation of the LED strip
- installation in a small gap 5x14 mm
- possibility of installation in an arc (minimum bend cap radius 25 cm)
- continuous line of light when

- łatwy montaż taśmy LED
- montaż w niewielkiej szczelinie 5x14 mm
- możliwość montażu po łuku (minimalny promień gięcia 25 cm)
- ciągła linia światła przy użyciu taśmy LED 120 P/m

- einfache Montage des LED Streifens
- Montage in einem kleinen Spalt 5x14 mm
- Möglichkeit der Montage nach einem Bogen (Mindestbiegeradius 25 cm)
- eine homogene Lichtlinie (bei Anwendung von LED Streifen mit 120 leds/m)

- installation facile du ruban LED
- installation dans un petit espace de 5x14 mm
- possibilité d'installation en arc (rayon de courbure minimum 25 cm)
- ligne continue de lumière en utilisant un ruban LED 120 P/M.



more
information

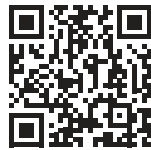

więcej
szczegółów



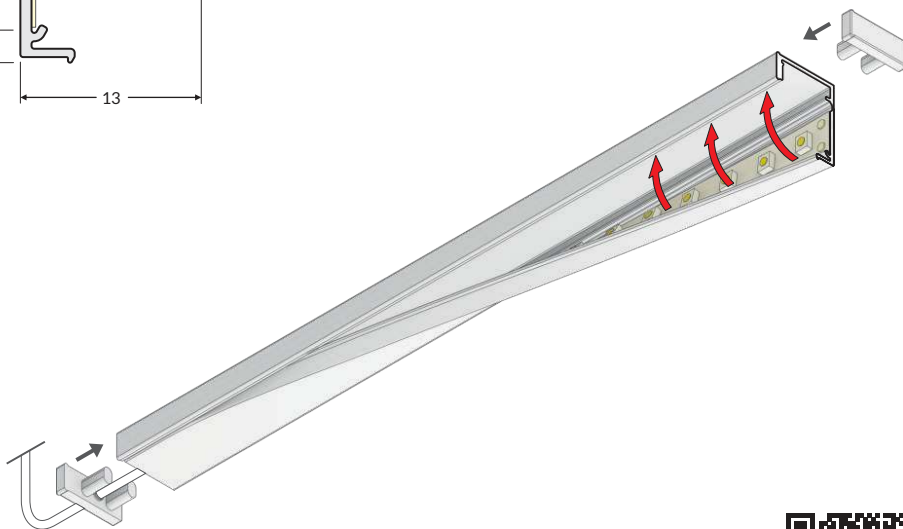
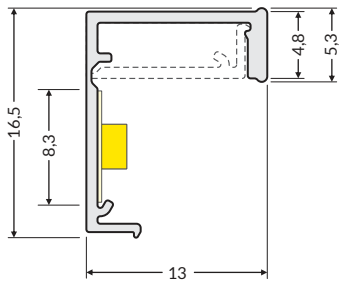

Technical manual
Instrukcja techniczna
Technische Anleitung
Manuel technique



material: PC opal
material: PC mleczny
Material: PC opal
matériau: PC opaque

1000 mm	G5000120
2000 mm	G5000220
3000 mm	G5000320
4100 mm	G5000420

end cap SLASH8
zaślepka SLASH8
Endkappe SLASH8
embout SLASH8



opal
mleczny
opal
opaque
G5999922



HI8 C1



max 8 mm



recessed
wpustowy
Einbauprofile
encastrés



furniture
meblowe
Möbel-
mobilier

- decorative illumination
- for counter edges, steps
- flushes with mounting surface
- only enlight surface of the diffuser is visible
- miniature dimensions

- oświetlenie dekoracyjne
- do montażu w krawędzi blatów, stopni
- zlicowany z powierzchnią montażową
- widoczna tylko świecąca powierzchnia klosza
- miniaturowe gabaryty

- dekorative Beleuchtung
- für die Montage am Rand von Platten, Stufen
- mit der Montagefläche gepasst
- sichtbar ist nur die leuchtende Oberfläche der Abdeckung
- Miniaturbaumasse

- éclairage décoratif
- pour l'installation dans le bord des comptoirs, des marches
- affleure la surface de montage
- seule la surface lumineuse du diffuseur est visible
- dimensions miniatures



more
information



więcej
szczegółów



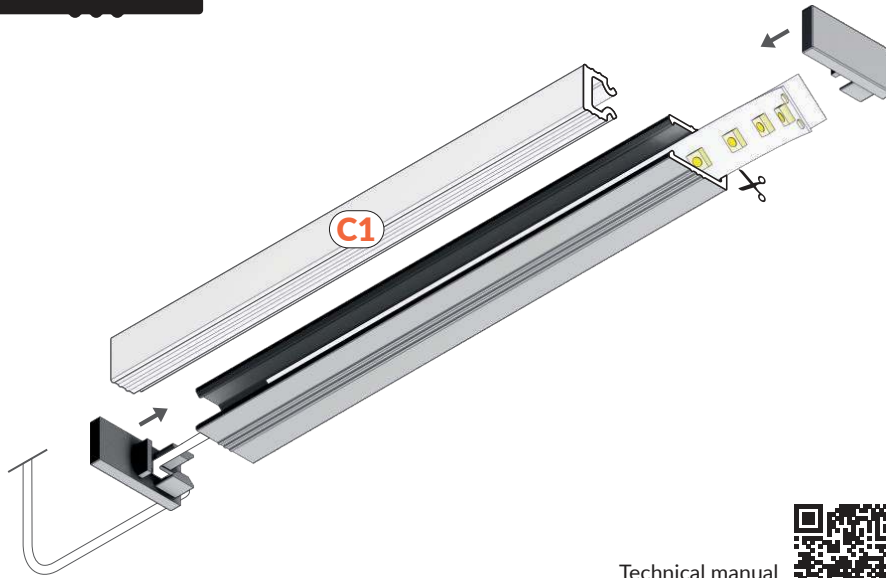
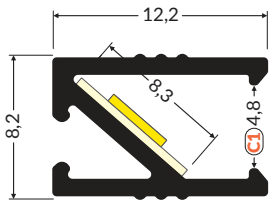

C1 → 195

diffuser C1 click
 klosz C1 klik
 Abdeckung C1 einclipsbar
 diffuseur C1 clic

Technical manual
 Instrukcja techniczna
 Technische Anleitung
 Manuel technique

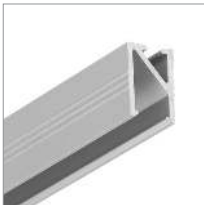
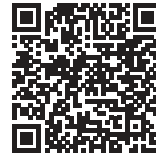

anodized
 anodowany
 eloxiert
 surface anodisée

1000 mm	H8010020
2000 mm	H8020020
3000 mm	H8030020
4050 mm	H8040020

end cap HI8
 zaślepka HI8
 Endkappe HI8
 embout HI8



silver	grey
srebrny	szary
silbern	grau
argent	gris
H8990040	H8990022

opal
 mleczny
 opal
 opaque
H8990038

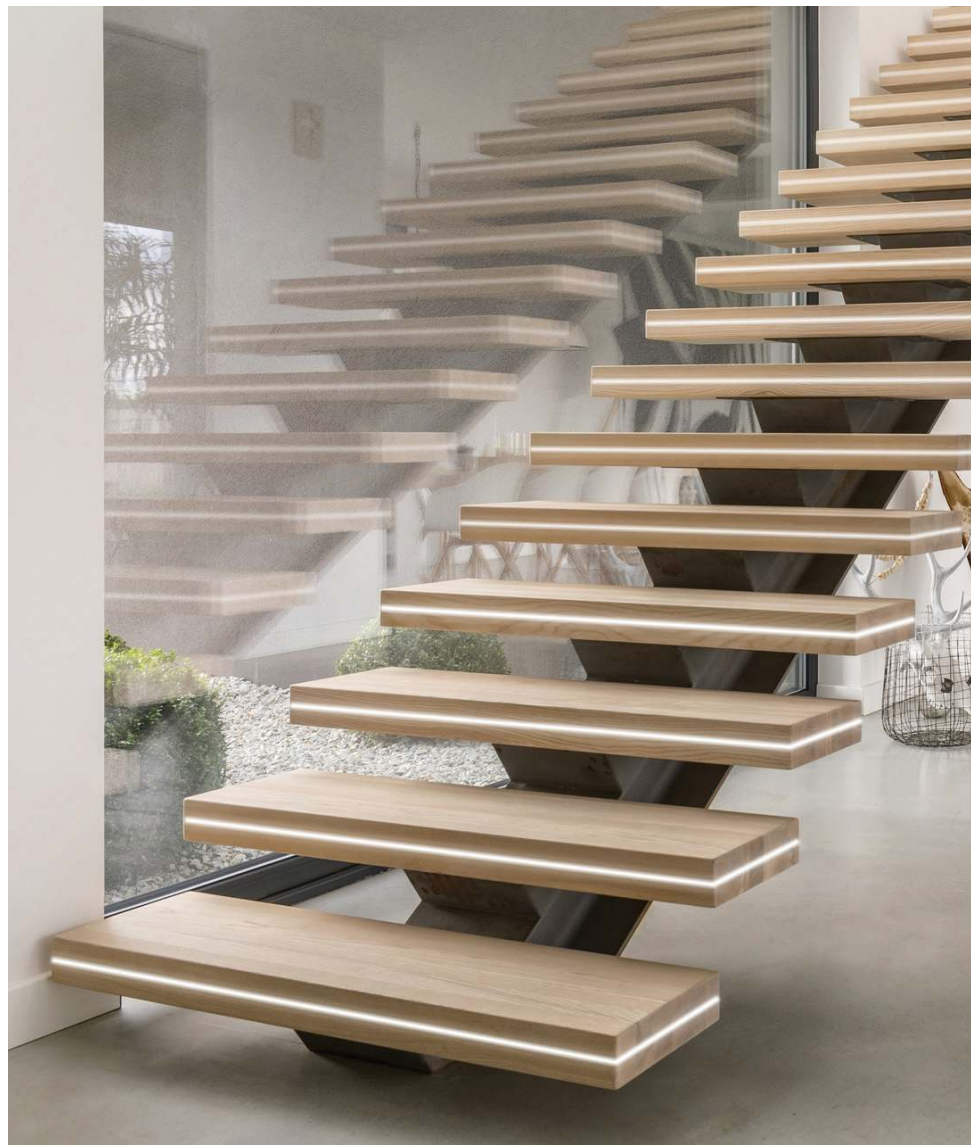



max 10 mm



recessed
wpustowy
Einbauprofile
encastrés



furniture
meblowe
Möbel-
mobilier

- suitable for use in plasterboards - does not affect the structure of the board
- used also in furniture
- continuous line of light (when using LED strip 120 p/m and opal diffuser)
- Slick socket
- miniature dimensions

- do zastosowania w płycie gipsowo-kartonowej - nie narusza konstrukcji płyty
- również do zastosowania meblowego
- ciągła linia światła (przy zastosowaniu taśmy 120 P/m i klosza mlecznego)
- gniazdo z funkcją Slick
- miniaturowe gabaryty

- für die Anwendung in einer Rigipsplatte - es beeinträchtigt die Struktur der Platte nicht
- auch für die Möbelanwendung
- eine homogene Lichtlinie (unter Verwendung von LED Streifen mit 120 leds/m und einer opalen Abdeckung)
- Sockel mit Slick Funktion
- Miniaturbaumasse

- pour une utilisation dans les plaques de plâtre - cela n'affecte pas la structure de la plaque
- aussi pour les les mobiliers
- une ligne continue de lumière (en utilisant un ruban 120 P/M. et un diffuseur opaque)
- prise avec fonction Slick
- dimensions miniatures



more
information



więcej
szczegółów

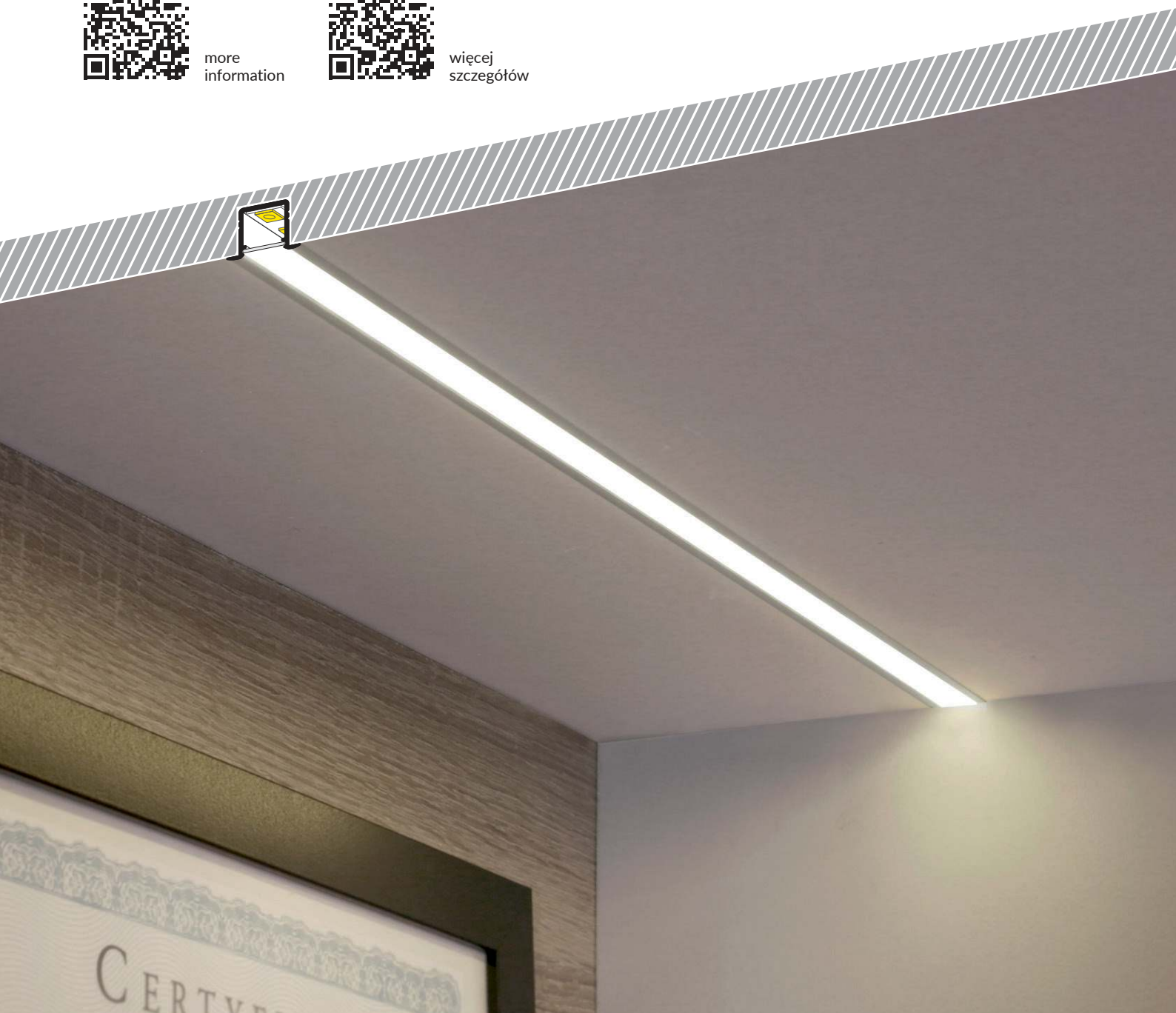

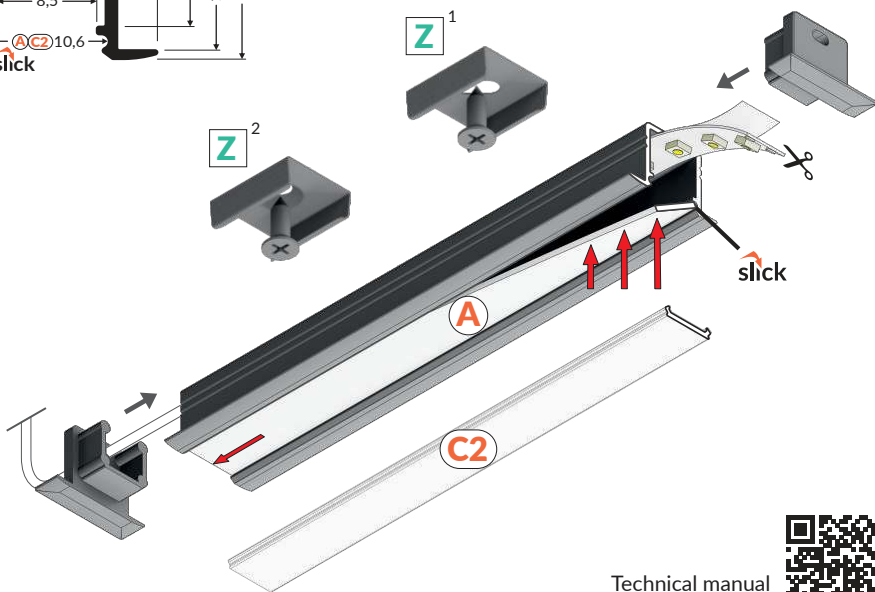
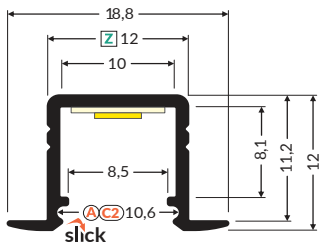

Technical manual
Instrukcja techniczna
Technische Anleitung
Manuel technique



Z¹ → 208

mounting plate Z
uchwyt Z
Halter Z
fixation Z

Z² → 208

mounting plate Z cone
uchwyt Z cone
Halter Z cone
fixation Z cône

A → 194

diffuser A slide
klosz A wsuwany
Abdeckung A einschiebbar
diffuseur A coulissant

C2 → 196

diffuser C2 click
klosz C2 klik
Abdeckung C2 einclipsbar
diffuseur C2 clic



white painted
biały malowany
weiß lackiert
peint en blanc

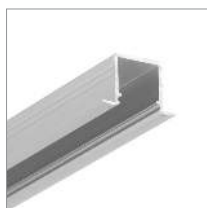

anodized
anodowany
eloxiert
surface anodisée



black anodized
czarny anodowany
schwarz eloxiert
noir anodisé



raw aluminium
surowe aluminium
Rohaluminium
aluminium brut

1000 mm	E3010001	E3010020	E3010021	E3010000
2000 mm	E3020001	E3020020	E3020021	E3020000
3000 mm	E3030001	E3030020	E3030021	E3030000
4050 mm	E3040001	E3040020	E3040021	E3040000

end cap SMART-IN10 with hole
zaślepka SMART-IN10 z otworem
Endkappe SMART-IN10 mit Öffnung
embout SMART-IN10 avec un trou



white silver
biały srebrny
weiß silbern
blanc argent
E3990001 **E3990040**

black grey
czarny szary
schwarz grau
noir gris
E3990002 **E3990022**

BEGTIN12 J/S



max 12 mm



recessed
wpustowy
Einbauprofile
encastrés



furniture
mebłowe
Möbel-
mobilier

- light weight, budget profile
- used mainly in furniture
- Slick socket

- lekki profil budżetowy
- głównie do zastosowania meblowego
- Gniazdo z funkcją Slick

- ein leichtes Budget-Profil
- hauptsächlich für die Möbelanwendung
- Sockel mit Slick Funktion

- profilé à prix bas, léger
- principalement pour les mobiliers
- prise avec fonction Slick



more
information



więcej
szczegółów



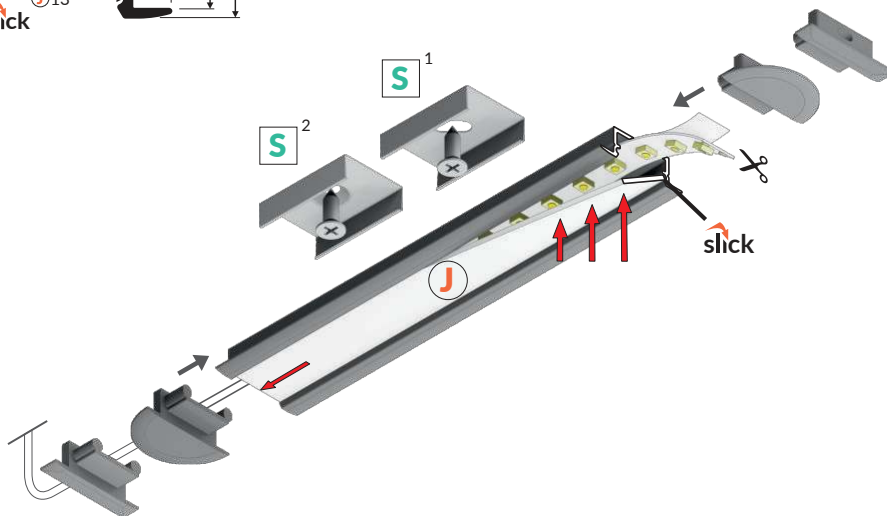
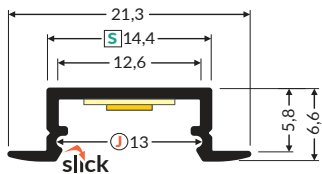

S¹ → 204

mounting plate S
uchwyt S
Halter S
fixation S

S² → 204

mounting plate S cone
uchwyt S cone
Halter S cone
fixation S cône

J → 200

diffuser J slide
klosz J wsuwany
Abdeckung J einschiebbar
diffuseur J coulissant

Technical manual
Instrukcja techniczna
Technische Anleitung
Manuel technique



white painted
biały malowany
weiß lackiert
peint en blanc

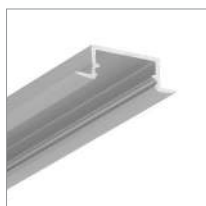

anodized
anodowany
eloxiert
surface anodisée



black anodized
czarny anodowany
schwarz eloxiert
noir anodisé



raw aluminium
surowe aluminium
Rohaluminium
aluminium brut

1000 mm	C8010001	C8010020	C8010021	C8010000
2000 mm	C8020001	C8020020	C8020021	C8020000
3000 mm	C8030001	C8030020	C8030021	C8030000
4050 mm	C8040001	C8040020	C8040021	C8040000

end cap BEGTIN12 gen2 with hole
zaślepka BEGTIN12 gen2 z otworem
Endkappe BEGTIN12 gen2 mit Öffnung
embout BEGTIN12 gen2 avec un trou



white	silver
biały	srebrny
weiß	silbern
blanc	argent
C8980001	C8980040

black	grey
czarny	szary
schwarz	grau
noir	gris
C8980002	C8980022

end cap BEGTIN12 gen2 SQ with hole
zaślepka BEGTIN12 gen2 SQ z otworem
Endkappe BEGTIN12 gen2 SQ mit Öffnung
embout BEGTIN12 gen2 SQ avec un trou



white	silver
biały	srebrny
weiß	silbern
blanc	argent
C8970001	C8970040

black	grey
czarny	szary
schwarz	grau
noir	gris
C8970002	C8970022



GROOVE10 BC/UX

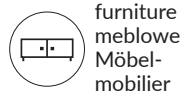

- used mainly in furniture
- ceiling installation possible
- 7 types of diffusers

- głównie do zastosowania meblowego
- możliwe zastosowanie sufitowe
- 7 rodzajów kloszy

- hauptsächlich für Möbelbereich
- möglich ist auch die Anwendung an der Decke
- 7 Abdeckungen zur Wahl

- principalement pour les mobiliers
- application possible au plafond
- 7 types de diffuseurs



more
information



więcej
szczegółów

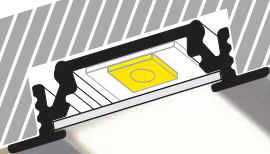

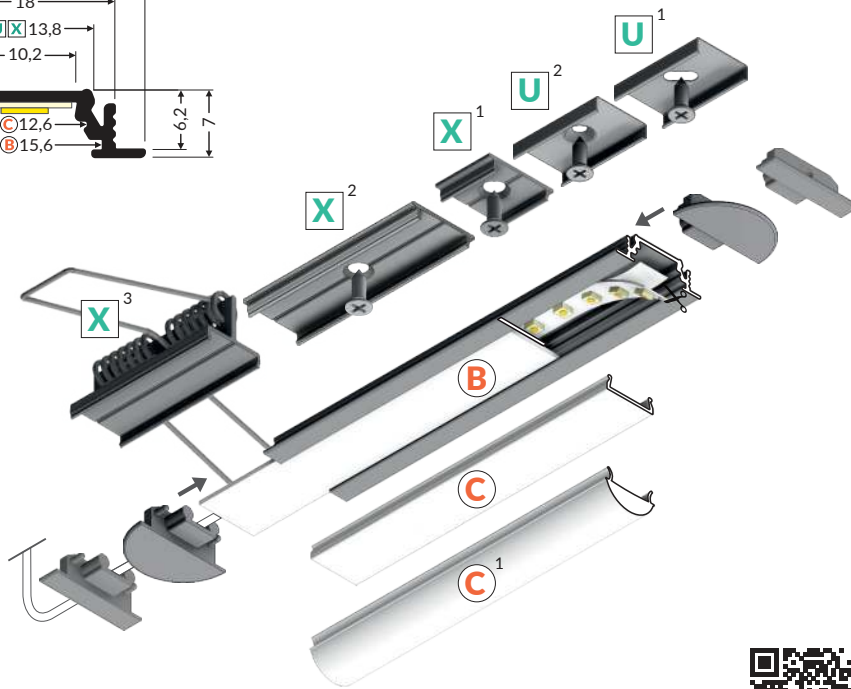
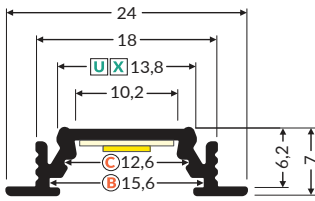

Technical manual
Instrukcja techniczna
Technische Anleitung
Manuel technique



U¹ → 204

mounting plate U
uchwyt U
Halter U
fixation U

U² → 204

mounting plate U cone
uchwyt U cone
Halter U cone
fixation U cône

X¹ → 207

mounting plate X
uchwyt X
Halter X
fixation X

X² → 207

connector X 180 deg
łącznik X 180 st
Verbinder X 180 Grad
connecteur X 180 degrés

X³ → 208

mounting plate X spring
uchwyt X sprężyna
Halter X Feder
fixation X ressort

B → 194

diffuser B slide
klosz B wsuwany
Abdeckung B einschiebbar
diffuseur B coulissant

C → 195

diffuser C click
klosz C klik
Abdeckung C einclipsbar
diffuseur C clic

C¹ → 195

diffuser C click lens gen2
klosz C klik soczewka gen2
Abdeckung C einclipsbar Linse gen2
diffuseur C clic lentille gen 2



white painted
biały malowany
weiß lackiert
peint en blanc



anodized
anodowany
eloxiert
surface anodisée



black anodized
czarny anodowany
schwarz eloxiert
noir anodisé



raw aluminium
surowe aluminium
Rohaluminium
aluminium brut

1000 mm	76200001	76200020	76200021	76200000
2000 mm	76210001	76210020	76210021	76210000
3000 mm	76690001	76690020	76690021	76690000
4050 mm	76700001	76700020	76700021	76700000

end cap GROOVE10 gen2 with hole
zaślepka GROOVE10 gen2 z otworem
Endkappe GROOVE10 gen2 mit Öffnung
embout GROOVE10 gen2 avec un trou



white
biały
weiß
blanc
76980001

silver
srebrny
silbern
argent
76980040

black
czarny
schwarz
noir
76980002

grey
szary
grau
gris
76980022

end cap GROOVE10 gen2 SQ with hole
zaślepka GROOVE10 gen2 SQ z otworem
Endkappe GROOVE10 gen2 SQ mit Öffnung
embout GROOVE10 gen2 SQ avec un trou



white
biały
weiß
blanc
76990001

silver
srebrny
silbern
argent
76990040

black
czarny
schwarz
noir
76990002

grey
szary
grau
gris
76990022

connector GROOVE10 90 deg
łącznik GROOVE10 90 st
Verbinder GROOVE10 90 Grad
connecteur GROOVE10 90 degrés

material: aluminium
materiał: aluminium
Material: Aluminium
matériel: aluminium

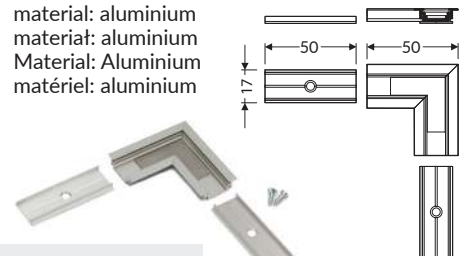

white painted
biały malowany
weiß lackiert
peint en blanc
76530001

anodized
anodowany
eloxiert
surface anodisée
76530020

black anodized
czarny anodowany
schwarz eloxiert
noir anodisé
76530021

GROOVE10.v2 A1C/U



max 10 mm



recessed
wpustowy
Einbauprofile
encastrés



furniture
meblowe
Möbel-
mobilier

- a new generation of recessed profiles
- basic and aesthetically pleasing furniture profile
- shallow mounting hole depth

- nowa generacja profili wpustowych
- podstawowy i estetyczny profil meblowy
- niewielka głębokość otworu montażowego

- neue Generation der Einbauprofile
- einfaches und ästhetisches Möbelprofil
- geringe Tiefe des Montagelochs

- nouvelle génération de profilés de rainure
- profilé de mobilier basique et esthétique
- faible profondeur du trou de montage



more
information



więcej
szczegółów



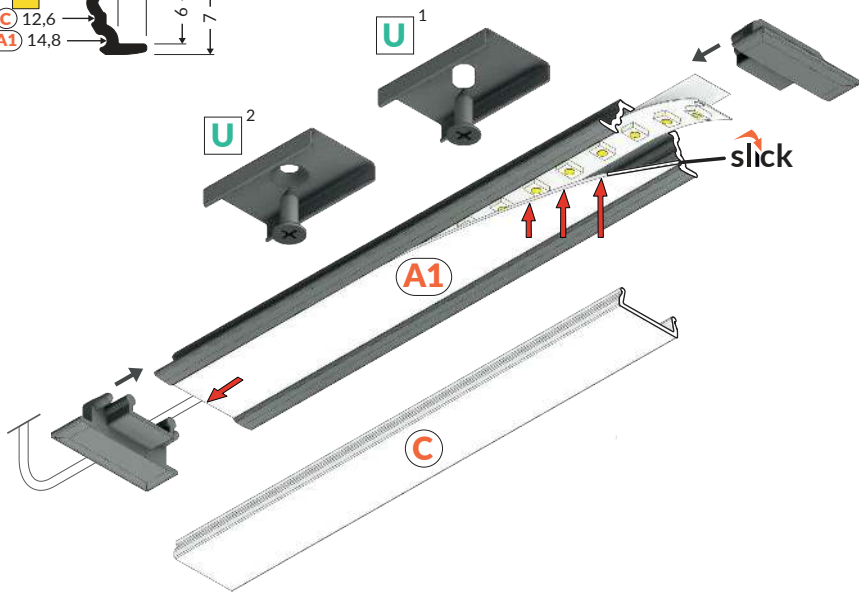
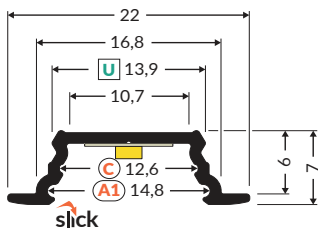

U¹ → 204
 mounting plate U
 uchwył U
 Halter U
 fixation U

U² → 204
 mounting plate U cone
 uchwył U cone
 Halter U cone
 fixation U cône

A1 → 194
 diffuser A1 slide
 klosz A1 wsuwany
 Abdeckung A1 einschiebbar
 diffuseur A1 coulissant

C → 195
 diffuser C klik
 klosz C klik
 Abdeckung C einclipsbar
 diffuseur C clic

			
white painted biały malowany weiß lackiert peint en blanc	anodized anodowany eloxiert surface anodisée	black anodized czarny anodowany schwarz eloxiert noir anodisé	raw aluminium surowe aluminium Rohaluminium aluminium brut
1000 mm K5000101	K5000120	K5000121	K5000100
2000 mm K5000201	K5000220	K5000221	K5000200
3000 mm K5000301	K5000320	K5000321	K5000300
4050 mm K5000401	K5000420	K5000421	K5000400

end cap GROOVE10.v2 with hole
 zaślepka GROOVE10.v2 z otworem
 Endkappe GROOVE10.v2 mit Öffnung
 embout GROOVE10.v2 avec un trou



white biały weiß blanc	silver srebrny silbern argent
K5999901	K5999940
black czarny schwarz noir	grey szary grau gris
K5999902	K5999922



GROOVE14 EE7F/TY



- used mainly in furniture
- many accessories available

- głównie do zastosowania
meblowego
- wiele akcesoriów do wyboru

- hauptsächlich für
Möbelanwendung
- viele Systemzubehörteile
zur Auswahl

- principalement pour les mobiliers
- de nombreux accessoires
au choix



more
information



więcej
szczegółów



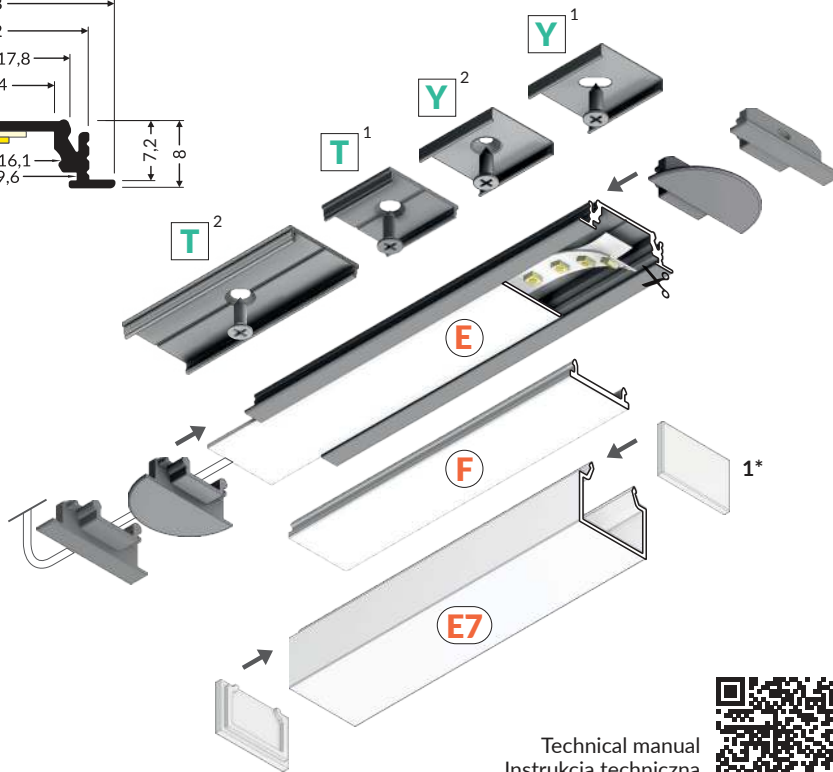
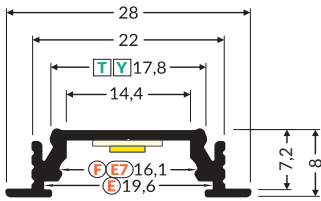

Technical manual
Instrukcja techniczna
Technische Anleitung
Manuel technique



Y¹ → 208

mounting plate Y
uchwyt Y
Halter Y
fixation Y

Y² → 208

mounting plate Y cone
uchwyt Y cone
Halter Y cone
fixation Y cône

T¹ → 204

mounting plate T
uchwyt T
Halter T
fixation T

T² → 204

connector T 180 deg
łącznik T 180 st
Verbinder T 180 Grad
connecteur T 180 degrés

E → 198

diffuser E slide
klosz E wsuwany
Abdeckung E einziehbar
diffuseur E coulissant

F → 199

diffuser F click
klosz F klik
Abdeckung F einclipsbar
diffuseur F clic

E7 → 198

diffuser E7 click
klosz E7 klik
Abdeckung E7 einclipsbar
diffuseur E7 clic

1* → 198

end cap E7
zaślepka E7
Endkappe E7
embout E7



white painted
biały malowany
weiß lackiert
peint en blanc



anodized
anodowany
eloxiert
surface anodisée



black anodized
czarny anodowany
schwarz eloxiert
noir anodisé



raw aluminium
surowe aluminium
Rohaluminium
aluminium brut

1000 mm	A3010001	A3010020	A3010021	A3010000
2000 mm	A3020001	A3020020	A3020021	A3020000
3000 mm	A3090001	A3090020	A3090021	A3090000
4050 mm	A3120001	A3120020	A3120021	A3120000

end cap GROOVE14 gen2 with hole
zaślepka GROOVE14 gen2 z otworem
Endkappe GROOVE14 gen2 mit Öffnung
embout GROOVE14 gen2 avec un trou



white biały weiß blanc	silver srebrny silbern argent
A3970001	A3970040

black czarny schwarz noir	grey szary grau gris
A3970002	A3970022

end cap GROOVE14 gen2 SQ with hole
zaślepka GROOVE14 gen2 SQ z otworem
Endkappe GROOVE14 gen2 SQ mit Öffnung
embout GROOVE14 gen2 SQ avec un trou



white biały weiß blanc	silver srebrny silbern argent
A3980001	A3980040

black czarny schwarz noir	grey szary grau gris
A3980002	A3980022

connector GROOVE14 90 deg
łącznik GROOVE14 90 st
Verbinder GROOVE14 90 Grad
connecteur GROOVE14 90 degrés

material: aluminium
materiał: aluminium
Material: Aluminium
matériel: aluminium

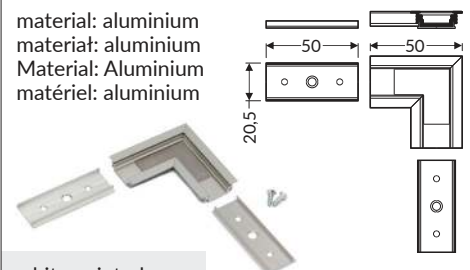

white painted
biały malowany
weiß lackiert
peint en blanc
A3990001

anodized
anodowany
eloxiert
surface anodisée
A3990020

black anodized
czarny anodowany
schwarz eloxiert
noir anodisé
A3990021

GROOVE14.v2 BC3/Y



max 14 mm



recessed
wpustowy
Einbauprofile
encastrés



furniture
meblowe
Möbel-
mobilier

- a new generation of recessed profiles
- basic and aesthetically pleasing furniture profile
- shallow mounting hole depth

- nowa generacja profili wpustowych
- podstawowy i estetyczny profil meblowy
- niewielka głębokość otworu montażowego

- neue Generation der Einbauprofile
- einfaches und ästhetisches Möbelprofil
- geringe Tiefe des Montagelochs

- nouvelle génération de profilés à encastrer
- profilé de mobilier basique et esthétique
- faible profondeur du trou de montage



more
information



więcej
szczegółów



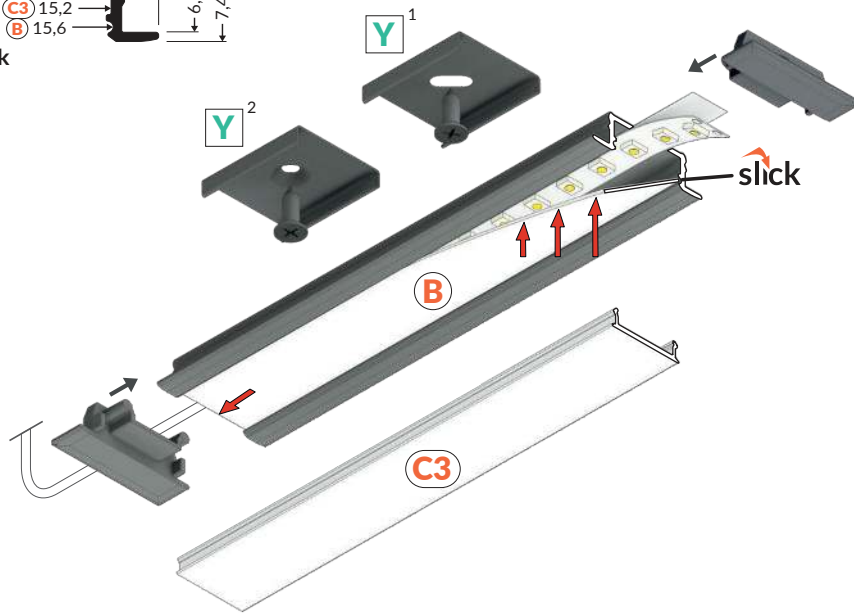
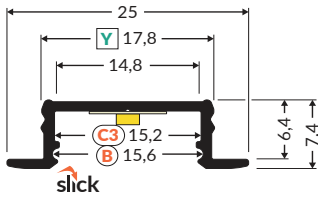

Y¹ → 208

mounting plate Y
uchwyt Y
Halter Y
fixation Y

Y² → 208

mounting plate Y cone
uchwyt Y cone
Halter Y cone
fixation Y cône

B → 194

diffuser B slide
klosz B wsuwany
Abdeckung B einschiebbar
diffuseur B coulissant

C3 → 196

diffuser C3 click
klosz C3 klik
Abdeckung C3 einclipsbar
diffuseur C3 clic



white painted
biały malowany
weiß lackiert
peint en blanc



anodized
anodowany
eloxiert
surface anodisée

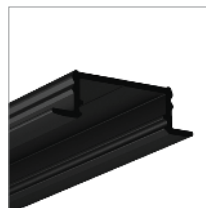

black anodized
czarny anodowany
schwarz eloxiert
noir anodisé



raw aluminium
surowe aluminium
Rohaluminium
aluminium brut

1000 mm	K6000101	K6000120	K6000121	K6000100
2000 mm	K6000201	K6000220	K6000221	K6000200
3000 mm	K6000301	K6000320	K6000321	K6000300
4050 mm	K6000401	K6000420	K6000421	K6000400

end cap GROOVE14.v2 with hole
zaślepka GROOVE14.v2 z otworem
Endkappe GROOVE14.v2 mit Öffnung
embout GROOVE14.v2 avec un trou



white
biały
weiß
blanc
K6999901

silver
srebrny
silbern
argent
K6999940

black
czarny
schwarz
noir
K6999902

grey
szary
grau
gris
K6999922



DIAGONAL14 F/TY



max 14 mm



recessed
wpustowy
Einbauprofile
encastrés



furniture
meblowe
Möbel-
mobilier

- reduced glare effect
- best for furniture applications

- zmniejszony efekt ośnienia
- głównie do zastosowania meblowego

- reduzierter Blendeffekt
- hauptsächlich für Möbelanwendung

- effet d'éblouissement réduit
- principalement pour le mobilier



more
information



więcej
szczegółów



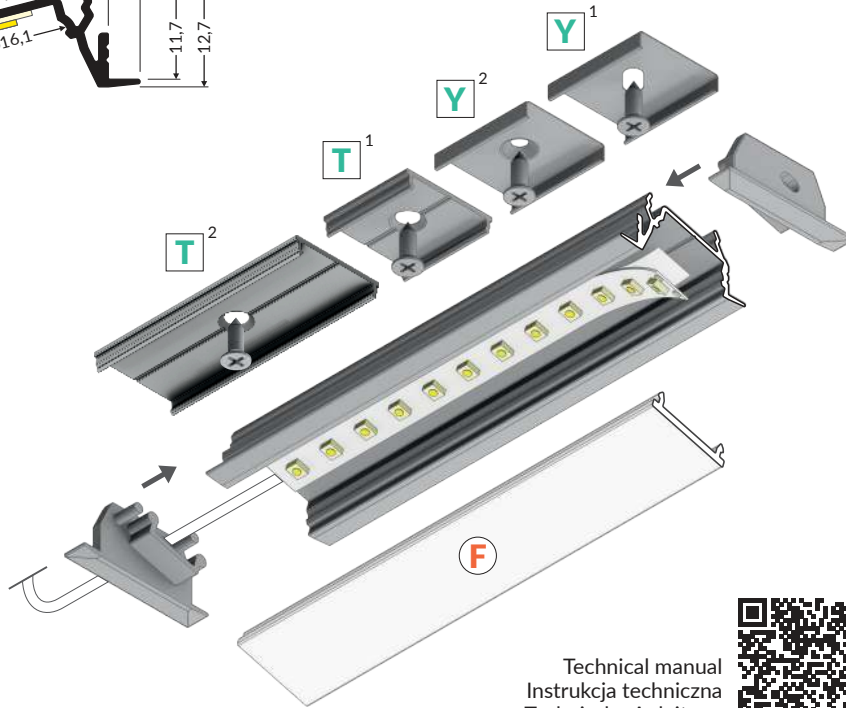
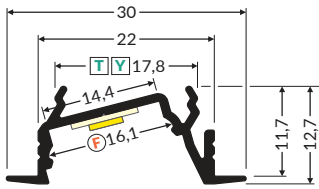

Technical manual
Instrukcja techniczna
Technische Anleitung
Manuel technique



Y¹ → 208

mounting plate Y
uchwyt Y
Halter Y
fixation Y

Y² → 208

mounting plate Y cone
uchwyt Y cone
Halter Y cone
fixation Y cône

T¹ → 204

mounting plate T
uchwyt T
Halter T
fixation T

T² → 204

connector T 180 deg
łącznik T 180 st
Verbinder T 180 Grad
connecteur T 180 degrés

F → 199

diffuser F click
klosz F klik
Abdeckung F einclipsbar
diffuseur F clic



white painted
biały malowany
weiß lackiert
peint en blanc



anodized
anodowany
eloxiert
surface anodisée



black anodized
czarny anodowany
schwarz eloxiert
noir anodisé



raw aluminium
surowe aluminium
Rohaluminium
aluminium brut

1000 mm	H5010001	H5010020	H5010021	H5010000
2000 mm	H5020001	H5020020	H5020021	H5020000
3000 mm	H5090001	H5090020	H5090021	H5090000
4050 mm	H5120001	H5120020	H5120021	H5120000

end cap DIAGONAL14 with hole
zaślepka DIAGONAL14 z otworem
Endkappe DIAGONAL14 mit Öffnung
embout DIAGONAL14 avec un trou



white
biały
weiß
blanc
H5999901

silver
srebrny
silbern
argent
H5999940

black
czarny
schwarz
noir
H5999902

grey
szary
grau
gris
H5999922

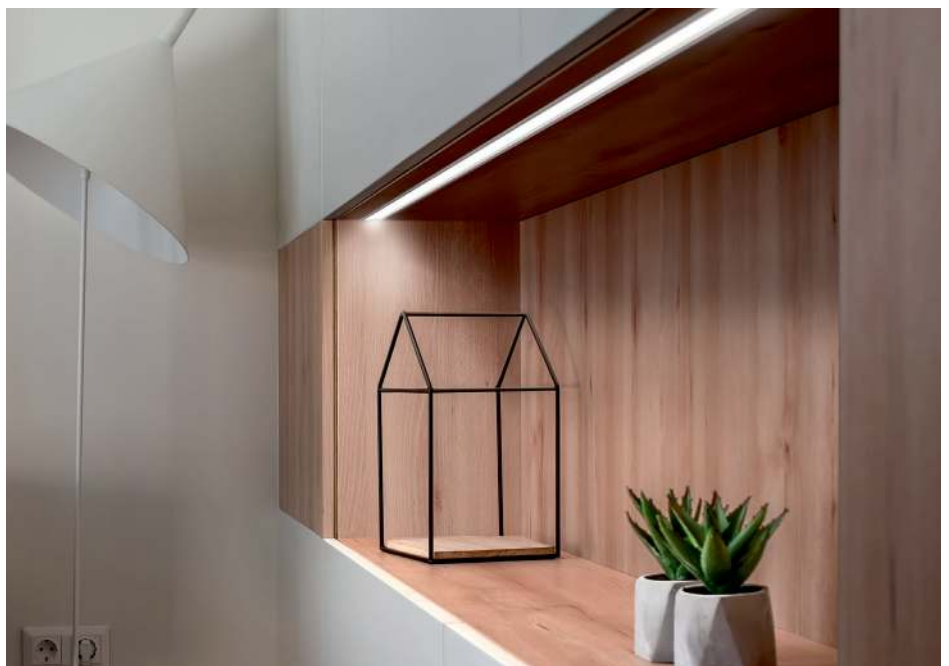

DEEP10 BC/UX



max 10 mm



recessed
wpustowy
Einbauprofile
encastrés



architectural
architektoniczne
architektonisch
architecture

- mainly used in furniture or plasterboard
- continuous line of light (when using LED strip 120 P/m and opal diffuser)
- angled profile sides are designed for better light reflection

- zastosowanie głównie meblowe lub w płycie karton-gips
- ciągła linia światła przy użyciu taśmy 120 P/m i klosza mlecznego
- ścianki profilu ustawione pod kątem działające jak odbłyśnik

- Anwendung hauptsächlich in Möbeln oder in Rigipsplatten
- eine homogene Lichtlinie unter Benutzung des LED Streifens mit 120 leds/m und einer opalen Abdeckung
- die Wänden des LED Profils unter einem Winkel eingestellt, die als Reflektor wirken

- principalement utilisé dans les meubles ou dans les plaques de plâtre
- une ligne de lumière continue à l'aide d'un ruban 120 P/m et d'un diffuseur opaque
- parois des profilés inclinés faisant office de réflecteur



more
information



więcej
szczegółów

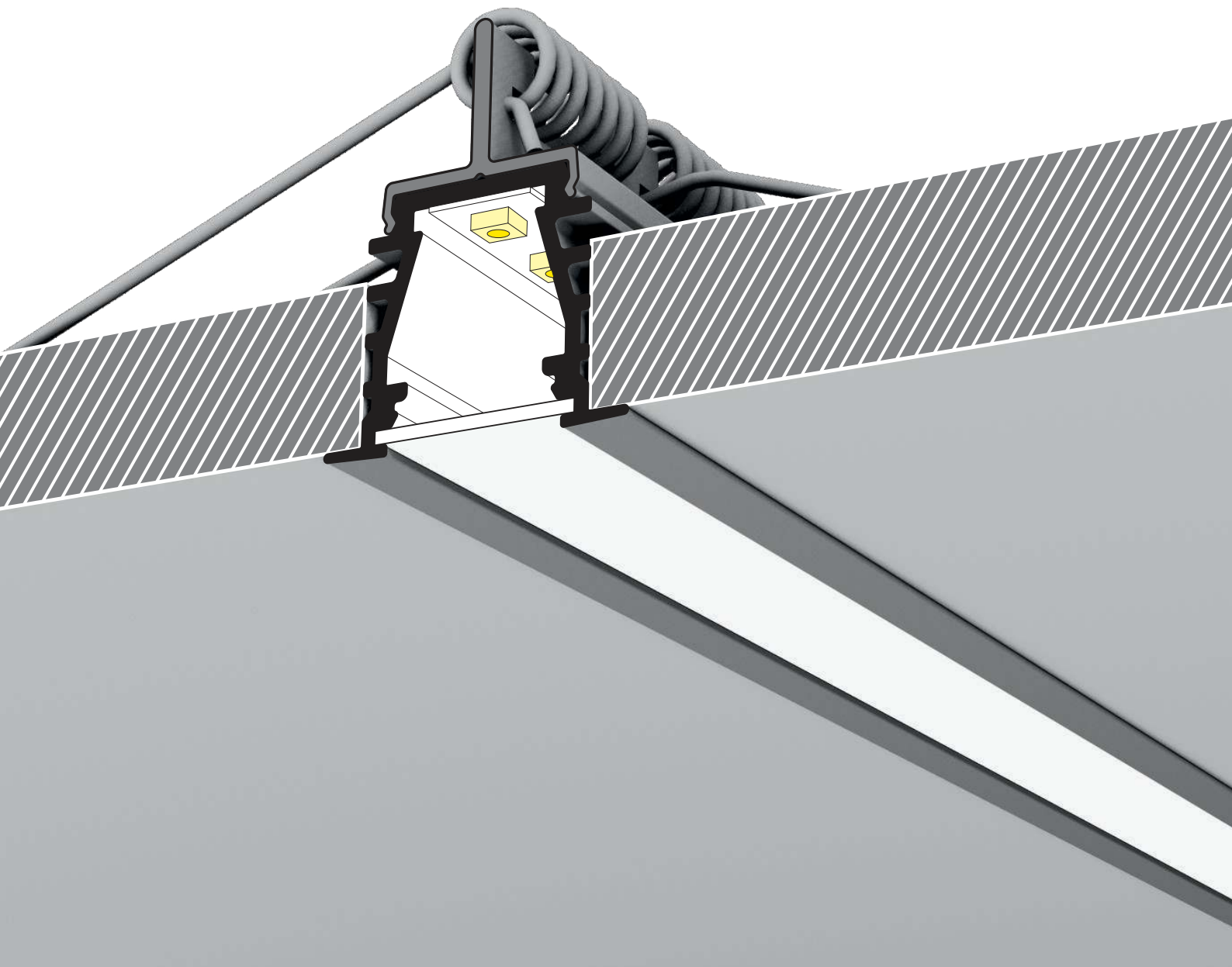

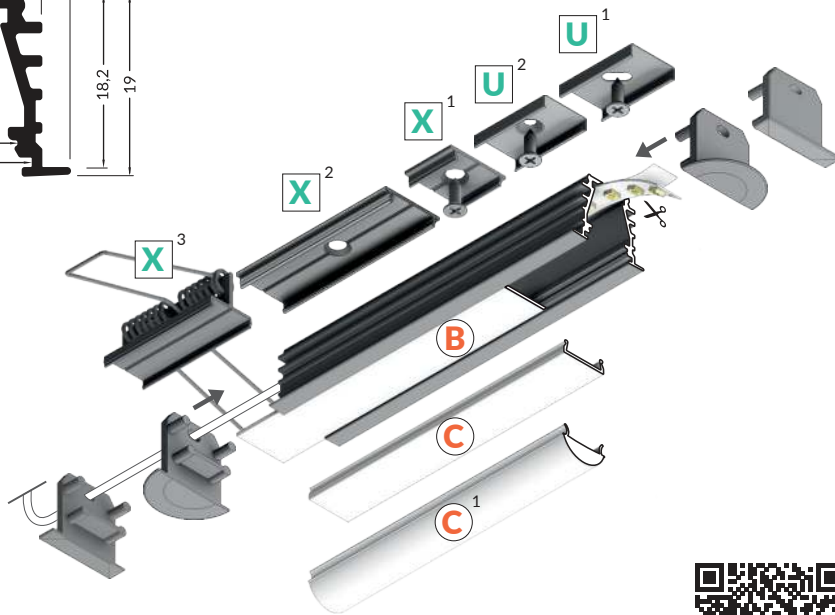
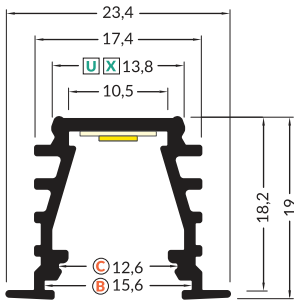

Technical manual
Instrukcja techniczna
Technische Anleitung
Manuel technique



U¹ → 204

mounting plate U
uchwyt U
Halter U
fixation U

U² → 204

mounting plate U cone
uchwyt U cone
Halter U cone
fixation U cône

X¹ → 207

mounting plate X
uchwyt X
Halter X
fixation X

X² → 207

connector X 180 deg
łącznik X 180 st
Verbinder X 180 Grad
connecteur X 180 degrés

X³ → 208

mounting plate X spring
uchwyt X sprężyna
Halter X Feder
fixation X ressort

B → 194

diffuser B slide
klosz B wsuwany
Abdeckung B einschiebbar
diffuseur B coulissant

C → 195

diffuser C click
klosz C klik
Abdeckung C einclipsbar
diffuseur C clic

C¹ → 195

diffuser C click lens gen2
klosz C klik soczewka gen2
Abdeckung C einclipsbar Linse gen2
diffuseur C clic lentille gen2



white painted
biały malowany
weiß lackiert
peint en blanc



anodized
anodowany
eloxiert
surface anodisée



black anodized
czarny anodowany
schwarz eloxiert
noir anodisé



raw aluminium
surowe aluminium
Rohaluminium
aluminium brut

1000 mm	96020001	96020020	96020021	96020000
2000 mm	96030001	96030020	96030021	96030000
3000 mm	96040001	96040020	96040021	96040000
4050 mm	96050001	96050020	96050021	96050000

end cap DEEP10 gen2 with hole
zaślepka DEEP10 gen2 z otworem
Endkappe DEEP10 gen2 mit Öffnung
embout DEEP10 gen2 avec un trou



white	silver
biały	srebrny
weiß	silbern
blanc	argent
96980001	96980040

black	grey
czarny	szary
schwarz	grau
noir	gris
96980002	96980022

end cap DEEP10 gen2 SQ with hole
zaślepka DEEP10 gen2 SQ z otworem
Endkappe DEEP10 gen2 SQ mit Öffnung
embout DEEP10 gen2 SQ avec un trou



white	silver
biały	srebrny
weiß	silbern
blanc	argent
96990001	96990040

black	grey
czarny	szary
schwarz	grau
noir	gris
96990002	96990022



SMART-IN16 BC3/U4



max 16 mm



recessed
wpustowy
Einbauprofile
encastrés



furniture
mebłowe
Möbel-
mobilier

- used mainly in furniture
- ceiling installation possible
- 6 types of diffusers

- głównie do zastosowania meblowego
- możliwe zastosowanie sufitowe
- 6 rodzajów kloszy

- auch für die Möbelanwendung
- Deckenmontage möglich
- 6 Abdeckungen zur Wahl

- principalement pour l'ameublement
- application au plafond possible
- 6 types de diffuseurs



more
information



więcej
szczegółów



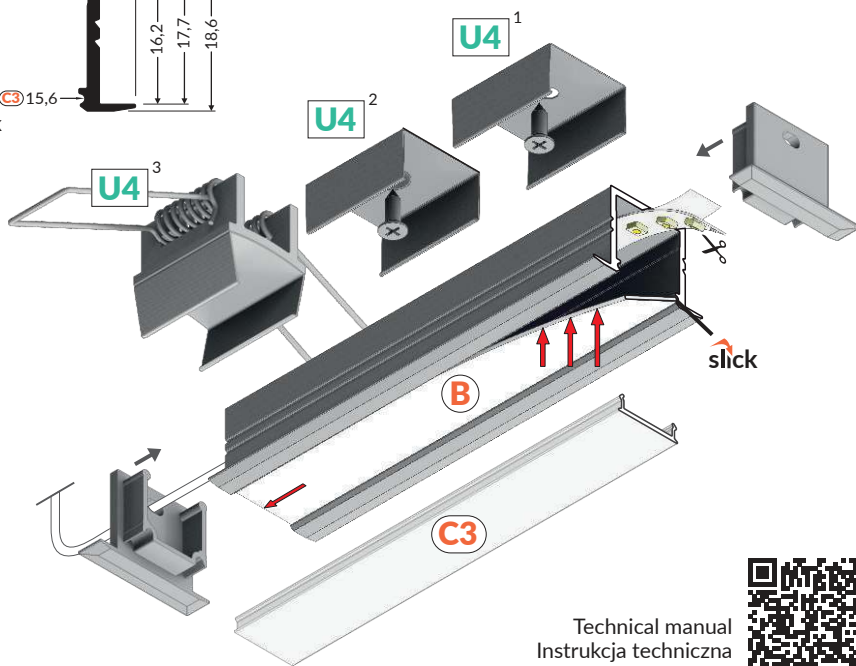
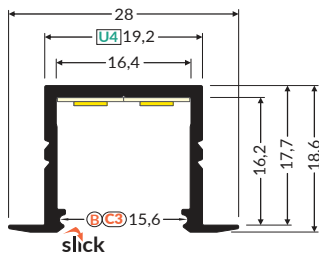

Technical manual
Instrukcja techniczna
Technische Anleitung
Manuel technique

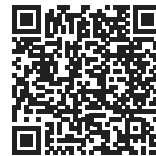

U4¹ → 205

mounting plate U4
uchwyt U4
Halter U4
fixation U4

U4² → 205

mounting plate U4 cone
uchwyt U4 cone
Halter U4 cone
fixation U4 cône

U4³ → 205

mounting plate U4 spring
uchwyt U4 sprężyna
Halter U4 Feder
fixation U4 ressort

B → 194

diffuser B slide
klosz B wsuwany
Abdeckung B einschiebbar
diffuseur B coulissant

C3 → 196

diffuser C3 click
klosz C3 klik
Abdeckung C3 einclipsbar
diffuseur C3 clic



white painted
biały malowany
weiß lackiert
peint en blanc



anodized
anodowany
eloxiert
surface anodisée



raw aluminium
surowe aluminium
Rohaluminium
aluminium brut

1000 mm	F6000101	F6000120	F6000100
2000 mm	F6000201	F6000220	F6000200
3000 mm	F6000301	F6000320	F6000300
4050 mm	F6000401	F6000420	F6000400

end cap SMART-IN16-BC3 with hole
zaślepka SMART-IN16-BC3 z otworem
Endkappe SMART-IN16-BC3 mit Öffnung
embout SMART-IN16-BC3 avec un trou



white
biały
weiß
blanc
F6999901

silver
srebrny
silbern
argent
F6999940

grey
szary
grau
gris
F6999922

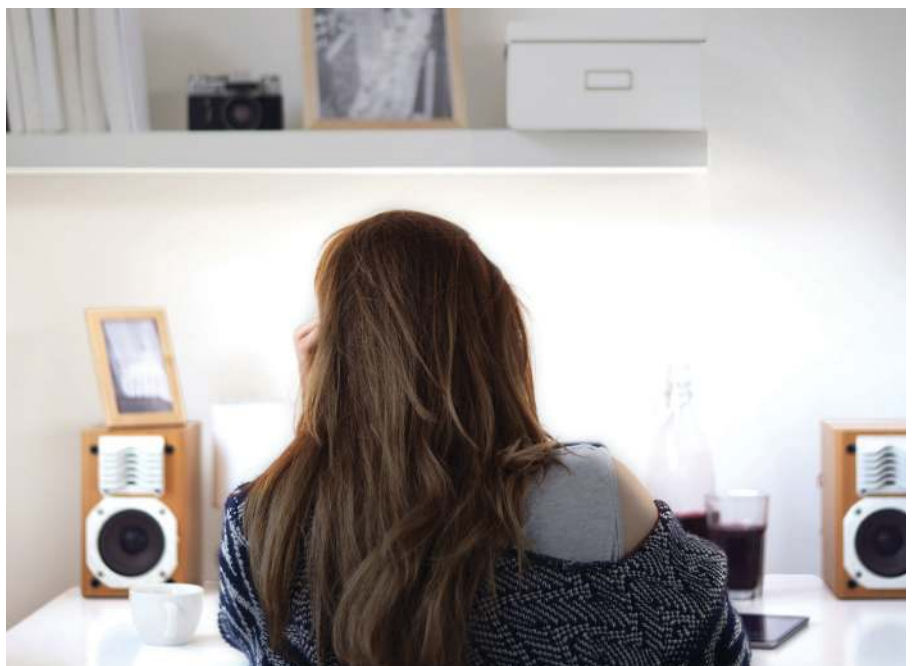

LINEA-IN20 EE7F/U7



max 20 mm



recessed
wpustowy
Einbauprofile
encastrés



architectural
architektoniczne
architektonisch
architecture



lighting
oświetleniowe
Beleuchtungs-
éclairage d'ambiance

- continuous line of light (when using LED strip 120 P/m and opal diffuser)
- angled connections illuminated
- over 20 accessories available

- ciągła linia światła (przy użyciu taśm 120 P/m oraz klosza mlecznego)
- świecące połączenia kątowe
- ponad 20 akcesoriów

- eine homogene Lichtlinie unter Anwendung des LED Streifens mit 120 leds/m und einer opalen Abdeckung
- leuchtende Eckverbindungen
- mehr als 20 Zubehörteile

- ligne continue de lumière (en utilisant le ruban 120 P/M. et un diffuseur)
- connecteurs d'angles éclairés
- plus de 20 accessoires



more
information



więcej
szczegółów



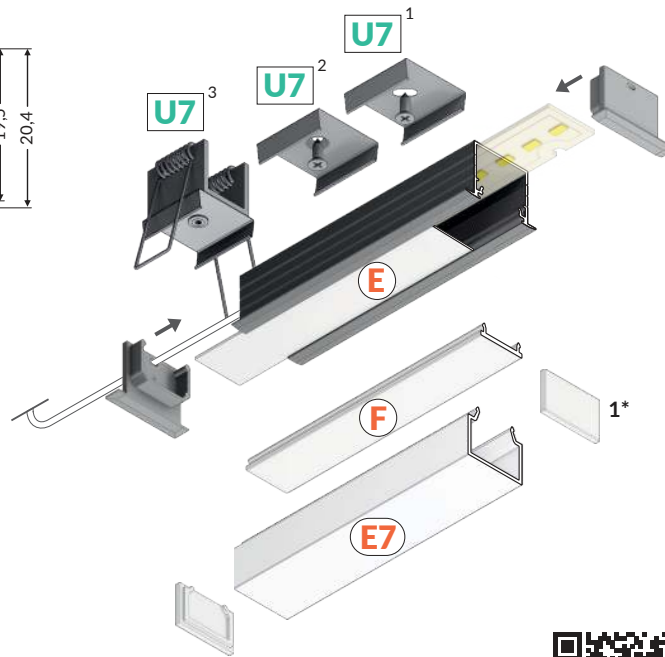
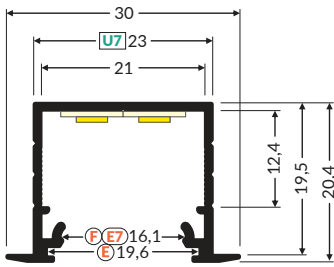

Technical manual
Instrukcja techniczna
Technische Anleitung
Manuel technique



U7¹ → 206

mounting plate U7
uchwyt U7
Halter U7
fixation U7

U7² → 206

mounting plate U7 cone
uchwyt U7 cone
Halter U7 cone
fixation U7 cône

U7³ → 206

mounting plate U7 spring
uchwyt U7 sprężyna
Halter U7 Feder
fixation U7 ressort

E → 198

diffuser E slide
klosz E wsuwany
Abdeckung E einschiebbar
diffuseur E coulissant

F → 199

diffuser F click
klosz F klik
Abdeckung F einclipsbar
diffuseur F clic

E7 → 198

diffuser E7 click
klosz E7 klik
Abdeckung E7 einclipsbar
diffuseur E7 clic

1* → 198

end cap E7
zaślepka E7
Endkappe E7
embout E7



white painted
biały malowany
weiß lackiert
peint en blanc



anodized
anodowany
eloxiert
surface anodisée



black anodized
czarny anodowany
schwarz eloxiert
noir anodisé



raw aluminium
surowe aluminium
Rohaluminium
aluminium brut

1000 mm	E4010001	E4010020	E4010021	E4010000
2000 mm	E4020001	E4020020	E4020021	E4020000
3000 mm	E4030001	E4030020	E4030021	E4030000
4050 mm	E4040001	E4040020	E4040021	E4040000

end cap LINEA-IN20 with hole
zaślepka LINEA-IN20 z otworem
Endkappe LINEA-IN20 mit Öffnung
embout LINEA-IN20 avec un trou



white biały weiß blanc	silver srebrny silbern argent
E4990001	E4990040

black czarny schwarz noir	grey szary grau gris
E4990002	E4990022

end cap LINEA-IN20-E7 with hole
zaślepka LINEA-IN20-E7 z otworem
Endkappe LINEA-IN20-E7 mit Öffnung
embout LINEA-IN20-E7 avec un trou



white biały weiß blanc	silver srebrny silbern argent
E4999901	E4999940

black czarny schwarz noir	grey szary grau gris
E4999902	E4999922

CONNECTION POSSIBILITY MOŻLIWOŚCI ŁĄCZENIA VERBINDUNGSMÖGLICHKEITEN COMBINAISON POSSIBLE

ANGULAR CONNECTORS

Thanks to five different angle connectors (60° / 90° / 120° / 135° / 180°)
it is possible to create many various lighting systems – with no need to cut the profile at an angle.
Bent connectors allows to connect profiles in two planes,
at two angles: 90° on the inside and 270° on the outside.

ŁĄCZNIKI KĄTOWE

Dzięki łącznikom o pięciu różnych kątach (60° / 90° / 120° / 135° / 180°)
możliwe jest tworzenie wielu różnych układów oświetlenia bez konieczności cięcia profilu pod skosem.
Łączniki gięte umożliwiają łączenie profili w dwóch płaszczyznach, pod dwoma kątami:
wewnętrznym 90° i zewnętrznym 270°.

ECKVERBINDER

Dank den Eckverbindern mit fünf unterschiedlichen Winkeln (60° / 90° / 120° / 135° / 180°)
ist es möglich die Bildung von vielen unterschiedlichen Lichtvarianten, ohne das Profil auf Gehrung zuschneiden müssen.
Gebogene Verbindungsstücke ermöglichen das Verbinden von zwei Profilen in zwei Ebenen, unter zwei Winkeln;
dem inneren Winkel von 90° und dem äußeren Winkel von 270°.

CONNECTEURS D'ANGLES

Grâce à des connecteurs avec cinq angles différents (60° / 90° / 120° / 135° / 180°),
il est possible de créer de nombreux systèmes d'éclairage différents sans qu'il soit nécessaire de couper le profilé en angle.
Les connecteurs pliables vous permettent de connecter des profilés dans deux plans, à deux angles:
90° interne et 270° externe.

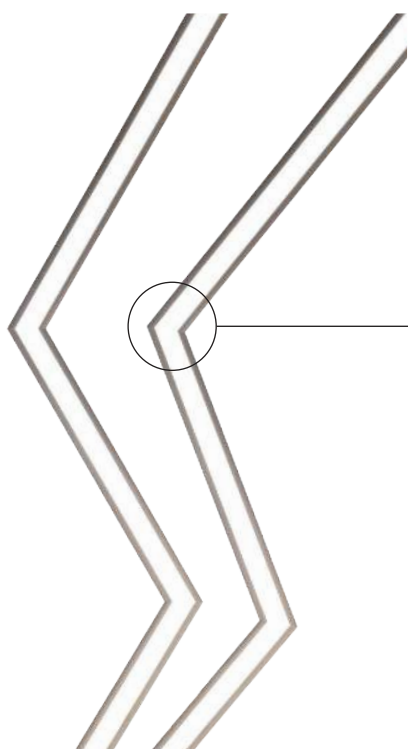
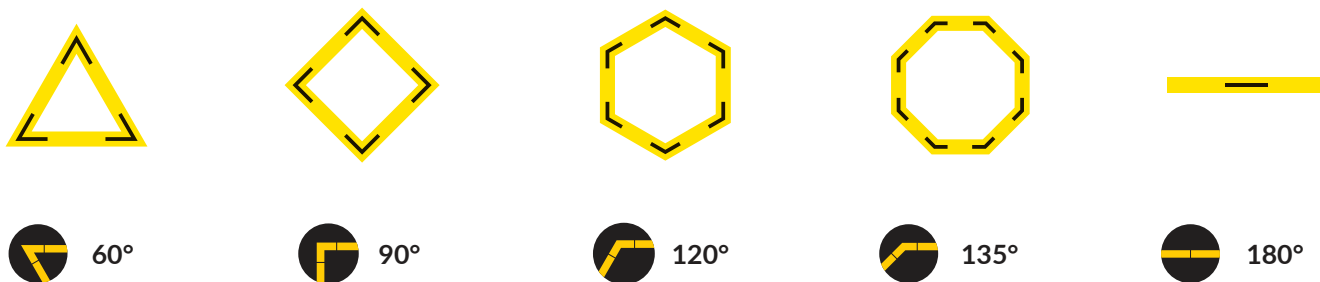

The component made of clear fabric provides secure connection, letting light through at the same time. Thanks to that, the luminaire can illuminate on the entire surface of the diffuser – even in the corners.

Element z przezroczystego tworzywa zapewnia stabilizację łączenia, jednocześnie przepuszczając światło. Dzięki temu oprawa może świecić na całej powierzchni klosza - również w rogach.

Ein Element aus durchsichtigem Kunststoff sichert die Stabilisierung der Verbindung und gleichzeitig lässt das Licht durch. Dadurch kann die Leuchte auf der ganzen Abdeckungsfläche leuchten - auch in den Ecken.

Un élément en matériau transparent assure la stabilisation de la connexion, tout en laissant passer la lumière. Grâce à cela, le luminaire peut briller sur toute la surface du diffuseur – également dans les angles.

CONNECTORS ŁĄCZNIKI VERBINDER CONNECTEURS

material: aluminium, polycarbonate
materiał: aluminium, poliwęglan
Material: Aluminium, Polycarbonat
matériel: aluminium, polycarbonate

connector LINEA-IN20 60 deg
łącznik LINEA-IN20 60 st
Verbinder LINEA-IN20 60 Grad
connecteur LINEA-IN20 degrés

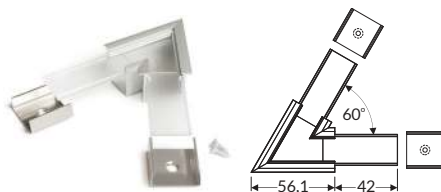

white painted
biały malowany
weiß lackiert
peint en blanc
E4890001S

anodized
anodowany
eloxiert
surface anodisée
E4890020S

black anodized
czarny anodowany
schwarz eloxiert
noir anodisé
E4890021S

connector LINEA-IN20 90 deg
łącznik LINEA-IN20 90 st
Verbinder LINEA-IN20 90 Grad
connecteur LINEA-IN20 degrés



white painted
biały malowany
weiß lackiert
peint en blanc
E4900001S

anodized
anodowany
eloxiert
surface anodisée
E4900020S

black anodized
czarny anodowany
schwarz eloxiert
noir anodisé
E4900021S

connector LINEA-IN20 90 deg bent
łącznik LINEA-IN20 90 st gięty
Verbinder LINEA-IN20 90 Grad gebogen
connecteur LINEA-IN20 90 degrés plié

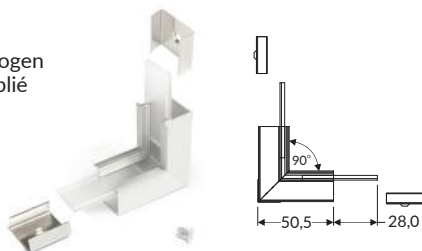

white painted
biały malowany
weiß lackiert
peint en blanc
E4910001S

anodized
anodowany
eloxiert
surface anodisée
E4910020S

black anodized
czarny anodowany
schwarz eloxiert
noir anodisé
E4910021S

connector LINEA-IN20 120 deg
łącznik LINEA-IN20 120 st
Verbinder LINEA-IN20 120 Grad
connecteur LINEA-IN20 120 degrés



white painted
biały malowany
weiß lackiert
peint en blanc
E4930001S

anodized
anodowany
eloxiert
surface anodisée
E4920020S

black anodized
czarny anodowany
schwarz eloxiert
noir anodisé
E4920021S

connector LINEA-IN20 135 deg
łącznik LINEA-IN20 135 st
Verbinder LINEA-IN20 135 Grad
connecteur LINEA-IN20 135 degrés

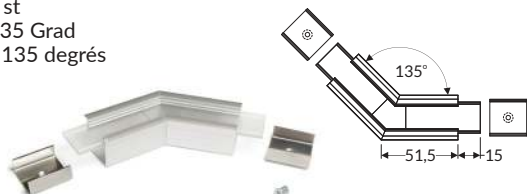

white painted
biały malowany
weiß lackiert
peint en blanc
E4920021S

anodized
anodowany
eloxiert
surface anodisée
E4930020S

black anodized
czarny anodowany
schwarz eloxiert
noir anodisé
E4930021S

connector LINEA-IN20 180 deg
łącznik LINEA-IN20 180 st
Verbinder LINEA-IN20 180 Grad
connecteur LINEA-IN20 180 degrés



E4940000S

connector LINEA-IN20 270 deg bent
łącznik LINEA-IN20 270 st gięty
Verbinder 270 LINEA-IN20 Grad gebogen
connecteur LINEA-IN20 270 degrés plié

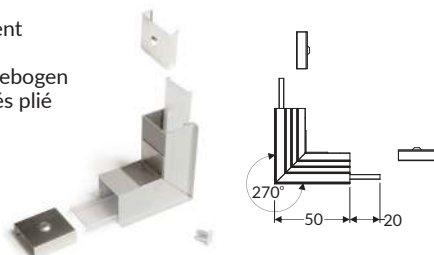

white painted
biały malowany
weiß lackiert
peint en blanc
E4950001S

anodized
anodowany
eloxiert
surface anodisée
E4950020S

black anodized
czarny anodowany
schwarz eloxiert
noir anodisé
E4950021S

VARIO30-06, 07



max 30 mm



recessed
wpustowy
Einbauprofile
encastrés



architectural
architektoniczne
Architectur
architecture

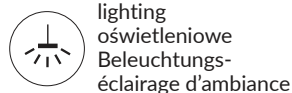

lighting
oświetleniowe
Beleuchtungs-
éclairage d'ambiance

- part of a larger system for luminaire construction
- multiple installation methods
- continuous line of light in angled connections
- unlimited possibilities for light creation

- część większego systemu do budowy opraw oświetleniowych
- wiele sposobów montażu
- ciągła linia światła w połączeniach kątowych
- nieograniczone możliwości kreowania światła

- Teil eines größeren Systems für den Leuchtenbau
- mehrere Montagemethoden
- homogene Lichtlinie in Winkelverbindungen
- unbegrenzte Möglichkeiten der Lichtgestaltung

- un élément d'un très vaste système pour la création de luminaires
- des plusieurs options de montage
- une ligne lumineuse permanente dans les connecteurs angulaires
- des possibilités illimitées concernant la création de lumière



VARIO30-06
ACDE-9/U9

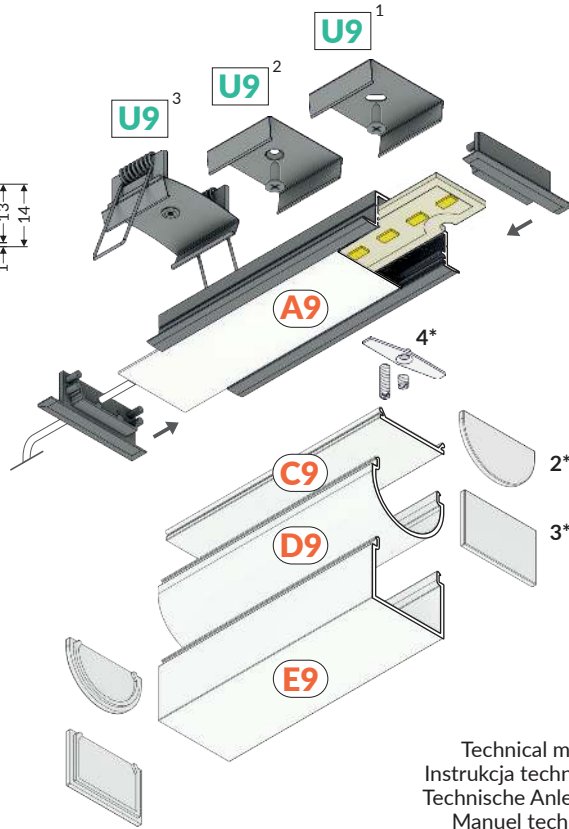
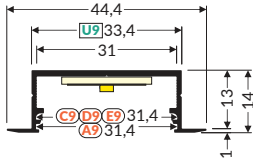

Technical manual
Instrukcja techniczna
Technische Anleitung
Manuel technique



U9¹ → 207

mounting plate U9
uchwyt U9
Halter U9
fixation U9

U9² → 207

mounting plate U9 cone
uchwyt U9 cone
Halter U9 cone
fixation U9 cône

U9³ → 207

mounting plate U9 spring
uchwyt U9 sprężyna
Halter U9 Feder
fixation U9 ressort

A9 → 194

diffuser A9 slide
klosz A9 wsuwany
Abdeckung A9 einschiebbar
diffuseur A9 coulissant

C9 → 197

diffuser C9 click
klosz C9 klik
Abdeckung C9 einclipsbar
diffuseur C9 clic

D9 → 198

diffuser D9 click
klosz D9 klik
Abdeckung D9 einclipsbar
diffuseur D9

E9 → 199

diffuser E9 click
klosz E9 klik
Abdeckung E9 einclipsbar
diffuseur E9 clic

2* → 198

end cap D9
zaślepka D9
Endkappe D9
embout D9

3* → 199

end cap E9
zaślepka E9
Endkappe E9
embout E9

4* → 210

LED clamp VARIO30
docisk LED VARIO30
LED Klemme VARIO30
clip de fixation LED VARIO30

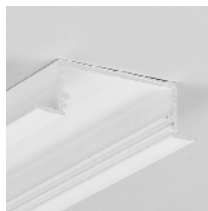

white painted
biały malowany
weiß lackiert
peint en blanc



anodized
anodowany
eloxiert
surface anodisée



black anodized
czarny anodowany
schwarz eloxiert
noir anodisé

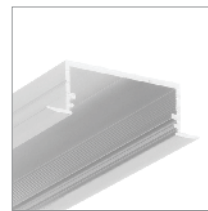

raw aluminium
surowe aluminium
Rohaluminium
aluminium brut

1000 mm	V3210001	V3210020	V3210021	V3210000
2000 mm	V3220001	V3220020	V3220021	V3220000
3000 mm	V3230001	V3230020	V3230021	V3230000
4050 mm	V3240001	V3240020	V3240021	V3240000

end cap VARIO30-06
zaślepka VARIO30-06
Endkappe VARIO30-06
embout VARIO30-06



white silver
biały srebrny
weiß silbern
blanc argent
V4920001 **V4920040**

black grey
czarny szary
schwarz grau
noir gris
V4920002 **V4920022**

VARIO30-07
ACDE-9/U9

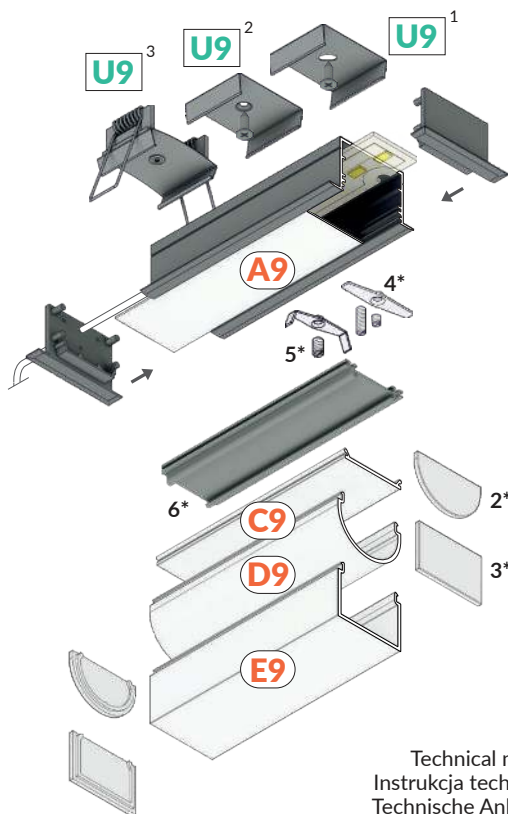
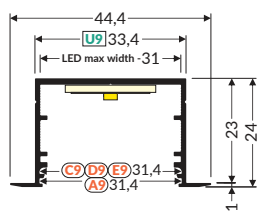

Technical manual
Instrukcja techniczna
Technische Anleitung
Manuel technique



more
information



więcej
szczegółów



U9¹ → 207

mounting plate U9
uchwyt U9
Halter U9
fixation U9

U9² → 207

mounting plate U9 cone
uchwyt U9 cone
Halter U9 cone
fixation U9 cône

U9³ → 207

mounting plate U9 spring
uchwyt U9 sprężyna
Halter U9 Feder
fixation U9 ressort

A9 → 194

diffuser A9 slide
klosz A9 wsuwany
Abdeckung A9 einschiebbar
diffuseur A9 coulissant

C9 → 197

diffuser C9 click
klosz C9 klik
Abdeckung C9 einclipsbar
diffuseur C9 clic

D9 → 198

diffuser D9 click
klosz D9 klik
Abdeckung D9 einclipsbar
diffuseur D9 clic

E9 → 199

diffuser E9 click
klosz E9 klik
Abdeckung E9 einclipsbar
diffuseur E9 clic

2* → 198

end cap D9
zaślepka D9
Endkappe D9
embout D9

3* → 199

end cap E9
zaślepka E9
Endkappe E9
embout E9

4* → 210

LED clamp VARIO30
docisk LED VARIO30
LED Klemme VARIO30
clip de fixation LED VARIO30

5* → 210

LED clamp VARIO30-1
docisk LED VARIO30-1
LED Klemme VARIO30-1
clip de fixation LED VARIO30 1

6* → 210

LED mounting VARIO30
mocowanie LED VARIO30
LED Montagetil VARIO30
fixation LED VARIO30



white painted
biały malowany
weiß lackiert
peint en blanc



anodized
anodowany
eloxiert
surface anodisée



black anodized
czarny anodowany
schwarz eloxiert
noir anodisé

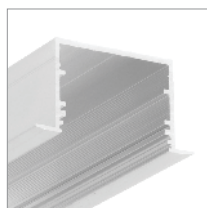

raw aluminium
surowe aluminium
Rohaluminium
aluminium brut

1000 mm
2000 mm
3000 mm
4050 mm

V3250001
V3260001
V3270001
V3280001

V3250020
V3260020
V3270020
V3280020

V3250021
V3260021
V3270021
V3280021

V3250000
V3260000
V3270000
V3280000

end cap VARIO30-07
zaślepka VARIO30-07
Endkappe VARIO30-07
embout VARIO30-07

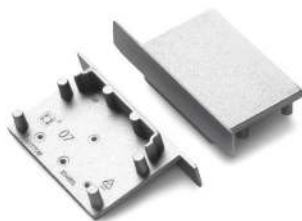

white
biały
weiß
blanc
V4930001

silver
srebrny
silbern
argent
V4930040

black
czarny
schwarz
noir
V4930002

grey
szary
grau
gris
V4930022

CONNECTORS ŁĄCZNIKI VERBINDER CONNECTEURS

material: aluminium, polycarbonate
materiał: aluminium, poliwęglan
Material: Aluminium, Polycarbonat
matériel: aluminium, polycarbonate

connector VARIO30-07 60 deg
łącznik VARIO30-07 60 st
Verbinder VARIO30-07 60 Grad
connecteur VARIO30-07 60 degrés

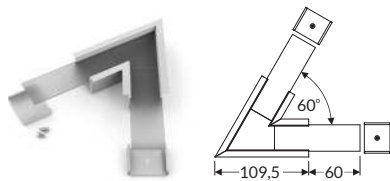

white painted
biały malowany
weiß lackiert
peint en blanc
V4780001S

anodized
anodowany
eloxiert
surface anodisée
V4780020S

black anodized
czarny anodowany
schwarz eloxiert
noir anodisé
V4780021S

connector VARIO30-07 90 deg
łącznik VARIO30-07 90 st
Verbinder VARIO30-07 90 Grad
connecteur VARIO30-07 90 degrés

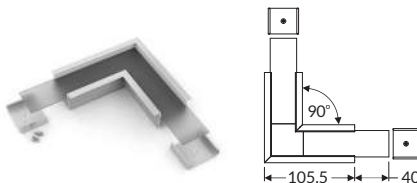

white painted
biały malowany
weiß lackiert
peint en blanc
V4790001S

anodized
anodowany
eloxiert
surface anodisée
V4790020S

black anodized
czarny anodowany
schwarz eloxiert
noir anodisé
V4790021S

connector VARIO30-07 90 deg bent
łącznik VARIO30-07 90 st gięty
Verbinder VARIO30-07 90 Grad gebogen
connecteur VARIO30-07 90 degrés plié

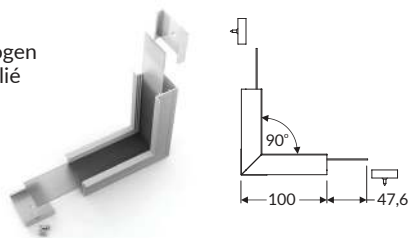

white painted
biały malowany
weiß lackiert
peint en blanc
V4800001S

anodized
anodowany
eloxiert
surface anodisée
V4800020S

black anodized
czarny anodowany
schwarz eloxiert
noir anodisé
V4800021S

connector VARIO30-07 120 deg
łącznik VARIO30-07 120 st
Verbinder VARIO30-07 120 Grad
connecteur VARIO30-07 120 degrés

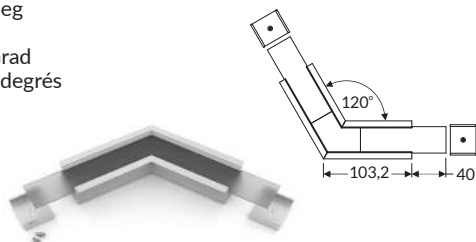

white painted
biały malowany
weiß lackiert
peint en blanc
V4810001S

anodized
anodowany
eloxiert
surface anodisée
V4810020S

black anodized
czarny anodowany
schwarz eloxiert
noir anodisé
V4810021S

connector VARIO30-07 135 deg
łącznik VARIO30-07 135 st
Verbinder VARIO30-07 135 Grad
connecteur VARIO30-07 135 degrés

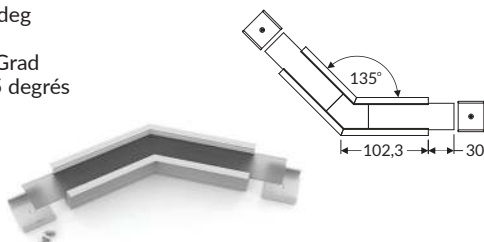

white painted
biały malowany
weiß lackiert
peint en blanc
V4820001S

anodized
anodowany
eloxiert
surface anodisée
V4820020S

black anodized
czarny anodowany
schwarz eloxiert
noir anodisé
V4820021S

connector VARIO30-07 180 deg
łącznik VARIO30-07 180 st
Verbinder VARIO30-07 180 Grad
connecteur VARIO30-07 180 degrés



V4610000S

connector VARIO30-07 270 deg bent
łącznik VARIO30-07 270 st gięty
Verbinder VARIO30-07 270 Grad gebogen
connecteur VARIO30-07 270 degrés plié

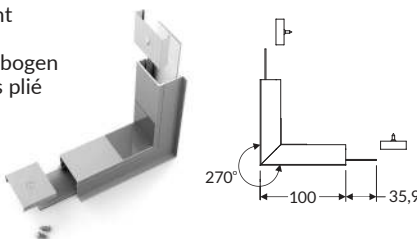

white painted
biały malowany
weiß lackiert
peint en blanc
V4830001S

anodized
anodowany
eloxiert
surface anodisée
V4830020S

black anodized
czarny anodowany
schwarz eloxiert
noir anodisé
V4830021S

FLAT8 H/UX



max 8 mm



recessed
wpustowy
Einbauprofile
encastrés



architectural
architektoniczne
architektonisch
architecture

- flat recessed profile emitting diffused light glow
- decorative illumination
- a parabolic, reflecting element – even, smooth, diffused light
- a flat profile, designed to fit into plasterboards – installation without interference in the frame construction
- mounted to furniture, walls, pedestals with holders (click-in) or directly (with screws, adhesive tape or glue)

- płaski, wpustowy profil emitujący rozproszoną łunę światła
- oświetlenie dekoracyjne
- paraboliczny odbłyśnik
- równomierne, gładkie, rozproszone światło
- płaski profil mieszczący się w grubości płyty karton-gips, montaż bez ingerencji w stelaż zabudowy
- montaż do mebli, ścian, cokołów za pomocą uchwytów (wklikując) lub bezpośrednio (przykręcając lub wklejając)

- flaches Einbauprofil, das den zerstreuten Lichtschein emittiert
- dekorative Beleuchtung
- ein parabelförmiger Reflektor - gleichmäßiges, glattes und zerstreutes Licht
- ein flaches Profil, dass in die Dicke der Rigipsplatte passt, die Montage gelingt ohne in den Bebauungsständer einzugreifen
- die Montage an den Möbeln, Wänden, an den Sockeln mit Hilfe von Haltern (durch Einclippen) oder direkt (durch das Zuschrauben oder Einkleben)

- éclairage décoratif
- réflecteur parabolique – lumière uniforme, douce et diffuse
- profilé plat d'une épaisseur de la plaque de plâtre, installation sans interférer avec la charpente du bâtiment
- montage dans les meubles, murs, plinthes avec fixations (par clic) ou directement (par vissage ou collage)



more
information



więcej
szczegółów

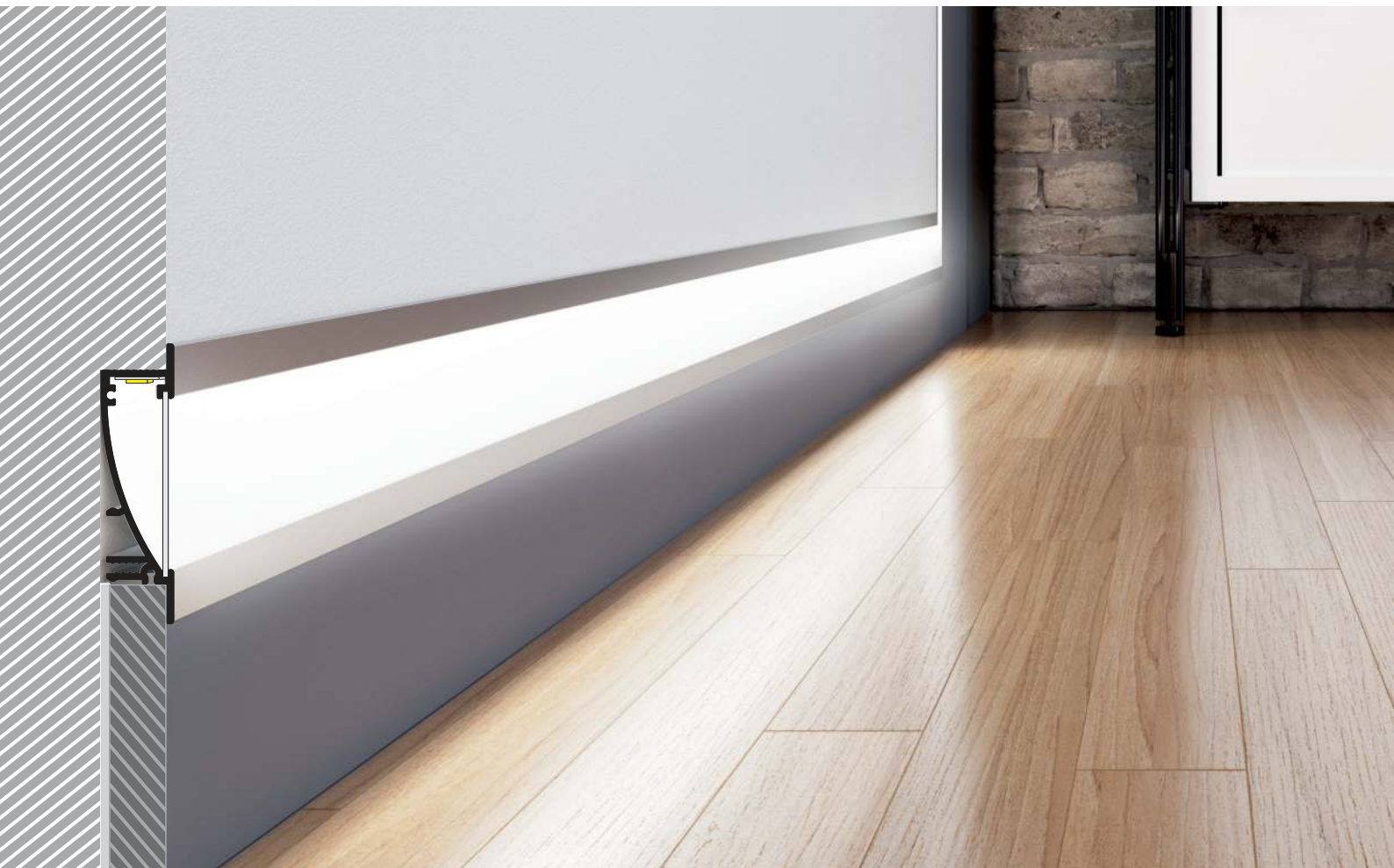

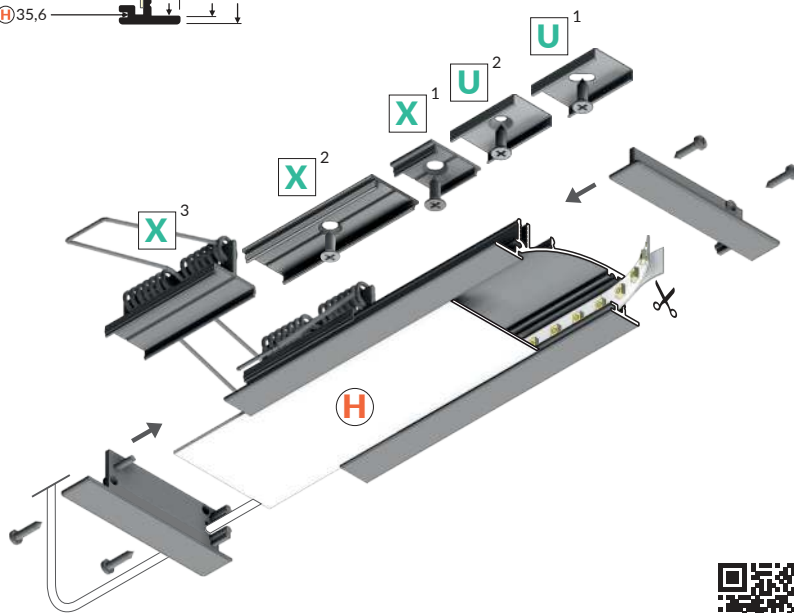
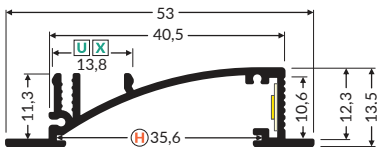

Technical manual
Instrukcja techniczna
Technische Anleitung
Manuel technique



U¹ → 204

mounting plate U
uchwyt U
Halter U
fixation U

U² → 204

mounting plate U cone
uchwyt U cone
Halter U cone
fixation U cône

X¹ → 207

mounting plate X
uchwyt X
Halter X
fixation X

X² → 207

connector X 180 deg
łącznik X 180 st
Verbinder X 180 Grad
connecteur X 180 degrés

X³ → 208

mounting plate X spring
uchwyt X sprężyna
Halter X Feder
fixation X ressort

H → 200

diffuser H slide
klosz H wsuwany
Abdeckung H einschiebbar
diffuseur H coulissant



white painted
biały malowany
weiß lackiert
peint en blanc



anodized
anodowany
eloxiert
surface anodisée



black anodized
czarny anodowany
schwarz eloxiert
noir anodisé



raw aluminium
surowe aluminium
Rohaluminium
aluminium brut

1000 mm	23040001	23040020	23040021	23040000
2000 mm	23050001	23050020	23050021	23050000
3000 mm	23200001	23200020	23200021	23200000
4050 mm	23210001	23210020	23210021	23210000

end cap FLAT8 with hole
zaślepka FLAT8 z otworem
Endkappe FLAT8 mit Öffnung
embout FLAT8 avec un trou



white
biały
weiß
blanc
23110001

silver
srebrny
silbern
argent
23110040

black
czarny
schwarz
noir
23110002

grey
szary
grau
gris
23110022



PHIL C10

RECESSED / WPUST / EINBAU / A ENCASTRER



max 46 mm



recessed
wpustowy
Einbauprofile
encastrés



architectural
architektoniczne
architektonisch
architecture



lighting
oświetleniowe
Beleuchtungs-
éclairage d'ambiance

- profile for creating LED luminaires
- perfect as main lighting
- 3 types of covers available with different light distributions

- profil do tworzenia opraw oświetleniowych
- doskonały jako oświetlenie główne
- dostępne 3 rodzaje kloszy o różnych rozsyłach światła

- Profil für die Erstellung von LED Leuchten
- perfekt als Hauptbeleuchtung
- 3 Arten von Abdeckungen mit unterschiedlichen Lichtverteilungen verfügbar

- profilés pour la création de luminaires LED
- un éclairage principal optimal
- 3 types de diffuseurs sont proposés avec des diffusion de la lumière différentes



more
information



więcej
szczegółów



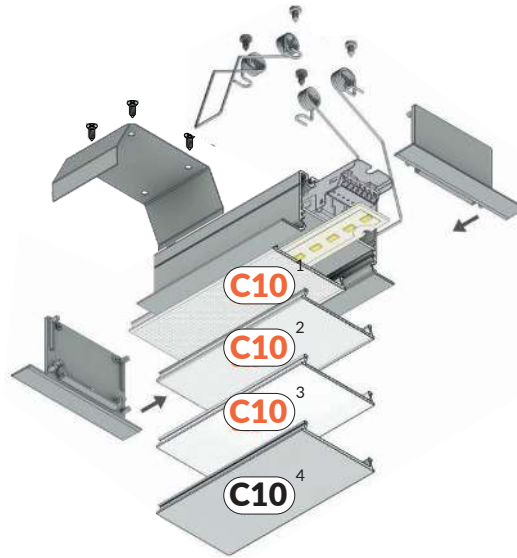
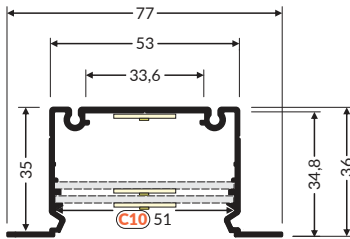

C10¹ → 197

diffuser C10 click OPAL
klosz C10 klik OPAL
Abdeckung C10
einclipsbar OPAL
diffuseur C10 clic OPAL

C10² → 197

diffuser C10 click NARROW
klosz C10 klik NARROW
Abdeckung C10
einclipsbar NARROW
diffuseur C10 clic NARROW

C10³ → 197

diffuser C10 click WIDE
klosz C10 klik WIDE
Abdeckung C10
einclipsbar WIDE
diffuseur C10 clic WIDE

white painted biały malowany weiß lackiert peint en blanc	anodized anodowany eloxiert surface anodisée	black painted czarny malowany schwarz lackiert peint en noir	raw aluminium surowe aluminium Rohaluminium aluminium brut
1000 mm 97090001	97090020	97090002	97090000
2000 mm 97100001	97100020	97100002	97100000
3000 mm 97110001	97110020	97110002	97110000
4050 mm 97370001	97370020	97370002	97370000

end cap PHIL RECESSED
zaślepka PHIL WPUST
Endkappe PHIL EINBAU
embout PHIL ENTRÉE



C10⁴

cover C10
osłona C10
Abdeckplatte C10
cache C10

white painted biały malowany weiß lackiert peint en blanc	anodized anodowany eloxiert surface anodisée	black painted czarny malowany schwarz lackiert peint en noir	raw aluminium surowe aluminium Rohaluminium aluminium brut
1000 mm 63550001	63550020	63550002	63550000
2000 mm 63560001	63560020	63560002	63560000
3000 mm 63740001	63740020	63740002	63740000
4050 mm 63750001	63750020	63750002	63750000

white
biały
weiß
blanc

silver
srebrny
silbern
argent

97990001S 97990040S

black
czarny
schwarz
noir

grey
szary
grau
gris

97990002S 97990022S

end cap PHIL RECESSED metal
zaślepka PHIL WPUST metal
Endkappe PHIL EINBAU Metall
embout PHIL ENTRÉE acier



white
biały
weiß
blanc

silver
srebrny
silbern
argent

97120001 97120022

black
czarny
schwarz
noir

97120002

holder PHIL RECESSED
uchwyt PHIL WPUST
Halter PHIL EINBAU
fixation PHIL ENTRÉE



material: stainless steel
materiał: stal nierdzewna
Material: Rostfreier Stahl
matériel: inox

97510019

holder PHIL RECESSED spring
uchwyt PHIL WPUST sprężyna
Halter PHIL EINBAU Feder
fixation PHIL ENTRÉE ressort



material: zinc coated steel
materiał: stal ocynkowana
Material: Verzinkter Stahl
matériel: acier galvanisé

97520030



**CORNER
KĄTOWE
ECKPROFILE
D'ANGLES**



QUARTER10 BD/U6



max 10 mm



corner
kątowy
Eckprofile
d'angles



furniture
meblowe
Möbel-
mobilier

- full circle quadrant illumination
- LED strip aligned to 45° angle
- Slick socket

- pełne oświetlenie ćwiartki koła
- taśma ustawiona pod kątem 45 stopni
- gniazdo Slick

- volle Beleuchtung eines Quadrants
- der Streifen unter dem Winkel von 45 Grad eingestellt
- Sockel mit Slick Funktion

- éclairage complet du quart de cercle
- installation de ruban à un angle de 45 degrés
- prise avec fonction Slick



more
information



więcej
szczegółów



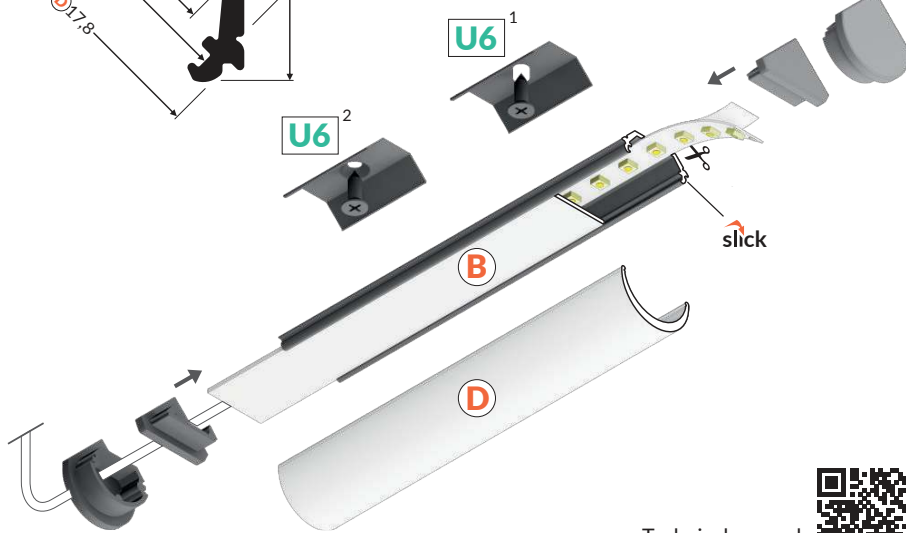
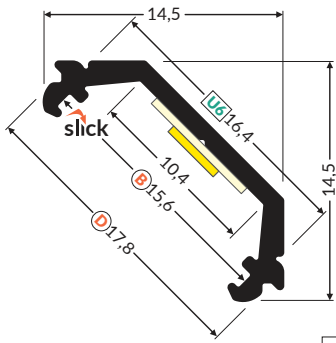

Technical manual
Instrukcja techniczna
Technische Anleitung
Manuel technique



U6¹ → 206

mounting plate U6
uchwyt U6
Halter U6
fixation U6

U6² → 206

mounting plate U6 cone
uchwyt U6 cone
Halter U6 cone
fixation U6 cône

B → 194

diffuser B slide
klosz B wsuwany
Abdeckung B einschiebbar
diffuseur B coulissant

D → 198

diffuser D click
klosz D klik
Abdeckung D einclipsbar
diffuseur D clic



anodized
anodowany
eloxiert
surface anodisée

1000 mm	D3010020
2000 mm	D3020020
3000 mm	D3030020
4050 mm	D3040020

end cap QUARTER10
zaślepka QUARTER10
Endkappe QUARTER10
embout QUARTER10



silver
srebrny
silbern
argent
D3980040

grey
szary
grau
gris
D3980022

end cap QUARTER10 D
zaślepka QUARTER10 D
Endkappe QUARTER10 D
embout QUARTER10 D



silver
srebrny
silbern
argent
D3990040

grey
szary
grau
gris
D3990022





max 12 mm



corner
kątowy
Eckprofile
d'angles



furniture
mebłowe
Möbel-
mobilier

- two lighting angles: 30°/60°
- small sizes, no holders and a channel for hiding cables
- minimum interference in glass show case's look
- Slick socket

- dwa kąty świecenia: 30°/60°
- niewielkie gabaryty, brak uchwytów oraz kanał do schowania przewodów
- minimalna ingerencja w wygląd szklanej gabloty
- gniazdo z funkcją Slick

- zwei Beleuchtungswinkel 30° und 60°
- Miniaturbaumasse, keine Halter und ein Kanal zum Leitungsverstecken
- minimaler Eingriff in das Aussehen der Glasvitrine
- Sockel mit Slick Funktion

- deux angles d'éclairage : 30°/60°
- petites dimensions, pas de fixations et un canal pour cacher les câbles
- profilé discret qui se fond dans la vitrine
- prise avec fonction Slick



more
information



więcej
szczegółów



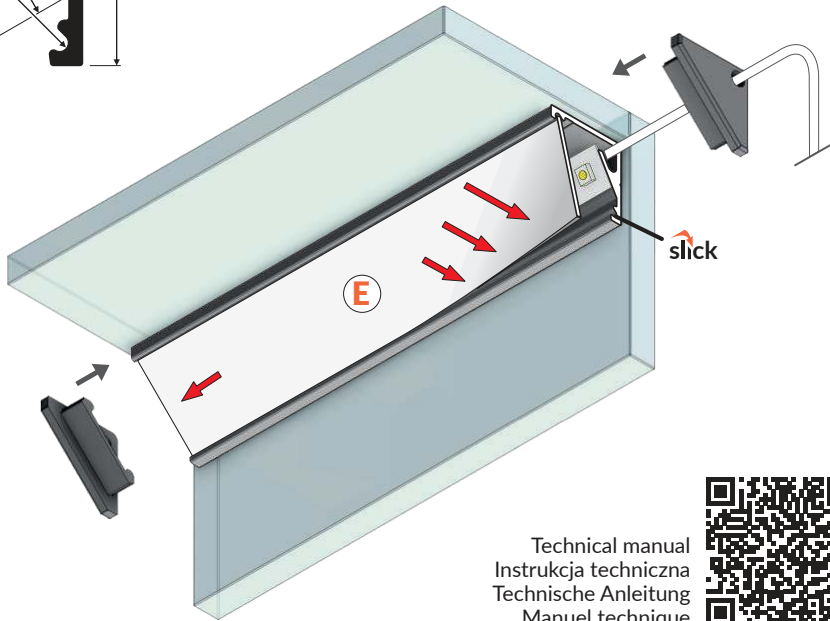
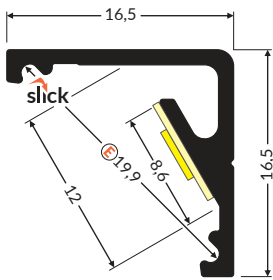

Technical manual
Instrukcja techniczna
Technische Anleitung
Manuel technique



E → 198

diffuser E slide
klosz E wsuwany
Abdeckung E einschiebbar
diffuseur E coulissant



white painted
biały malowany
weiß lackiert
peint en blanc



anodized
anodowany
eloxiert
surface anodisée



black anodized
czarny anodowany
schwarz eloxiert
noir anodisé



raw aluminium
surowe aluminium
Rohaluminium
aluminium brut

1000 mm	C9010001	C9010020	C9010021	C9010000
2000 mm	C9020001	C9020020	C9020021	C9020000
3000 mm	C9030001	C9020020	C9030021	C9030000
4050 mm	C9040001	C9040020	C9040021	C9040000

end cap CABI12
zaślepka CABI12
Endkappe CABI12
embout CABI12



white
biały
weiß
blanc
C9980001

silver
srebrny
silbern
argent
C9980040

black
czarny
schwarz
noir
C9980002

grey
szary
grau
gris
C9980022



max 12 mm



corner
kątowy
Eckprofile
d'angles



furniture
meblowe
Möbel-
mobilier

- designed for displaying products in glass cases
- two places to insert the LED strip
- minimalist, unobtrusive
- much lighter than the original

- zaprojektowany do ekspozycji produktów w szklanych gablotach
- dwa miejsca na wklejenie taśmy LED
- minimalistyczny, dyskretny
- dużo lżejszy od pierwowzoru

- entwickelt für die Präsentation von Waren in Glasvitrinen
- zwei Plätze fürs Einkleben von LED-Streifen
- minimalistisch, diskret
- viel leichter als der Prototyp

- conçu pour présenter les produits dans les vitrines
- deux endroits pour coller le ruban LED
- minimaliste, discret
- beaucoup plus léger que l'original



more
information



więcej
szczegółów



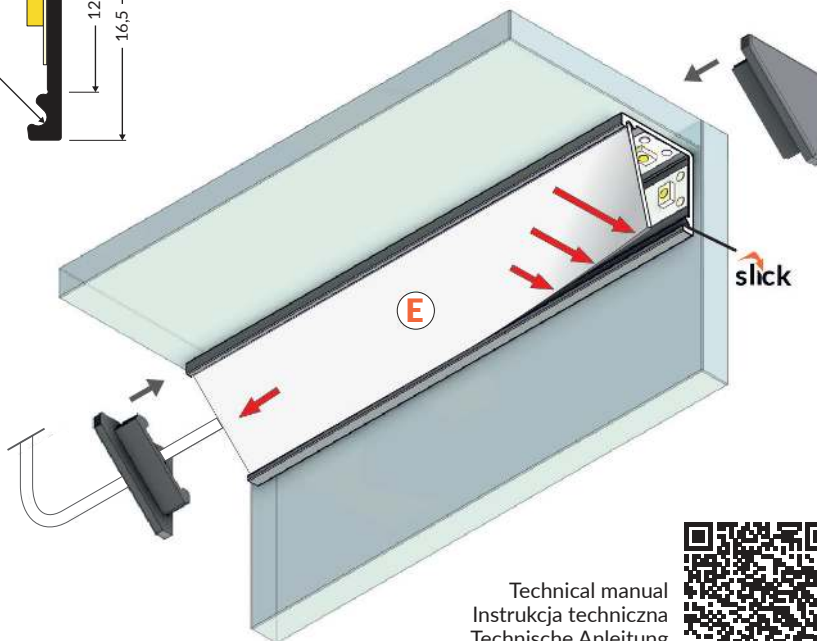
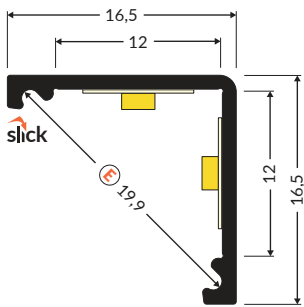

Technical manual
Instrukcja techniczna
Technische Anleitung
Manuel technique



E → 198

diffuser E slide
klosz E wsuwany
Abdeckung E einschiebbar
diffuseur E coulissant



white painted
biały malowany
weiß lackiert
peint en blanc



anodized
anodowany
eloxiert
surface anodisée



black anodized
czarny anodowany
schwarz eloxiert
noir anodisé



raw aluminium
surowe aluminium
Rohaluminium
aluminium brut

1000 mm	K2000101	K2000120	K2000121	K2000100
2000 mm	K2000201	K2000220	K2000221	K2000200
3000 mm	K2000301	K2000320	K2000321	K2000300
4050 mm	K2000401	K2000420	K2000421	K2000400

end cap CABI12
zaślepka CABI12
Endkappe CABI12
embout CABI12



white
biały
weiß
blanc
C9980001

silver
srebrny
silbern
argent
C9980040

black
czarny
schwarz
noir
C9980002

grey
szary
grau
gris
C9980022



CORNER10 BC/UX



max 10 mm



corner
kątowy
Eckprofile
d'angles



furniture
meblowe
Möbel-
mobilier

- lighting directions: 30° or 60°
- hidden mounting
- wide range of accessories,
7 types of diffusers

- dwa kąty świecenia: 30° i 60°
- ukryte mocowanie
- szeroki wybór akcesoriów,
7 rodzajów kloszy

- zwei Beleuchtungswinkel
30° und 60°
- eine versteckte Befestigung
- eine breite Zubehörwahl,
7 Arten der Abdeckungen

- deux angles
d'éclairage : 30 ° et 60 °
- fixation cachée
- large gamme d'accessoires,
7 types de diffuseurs



more
information



więcej
szczegółów



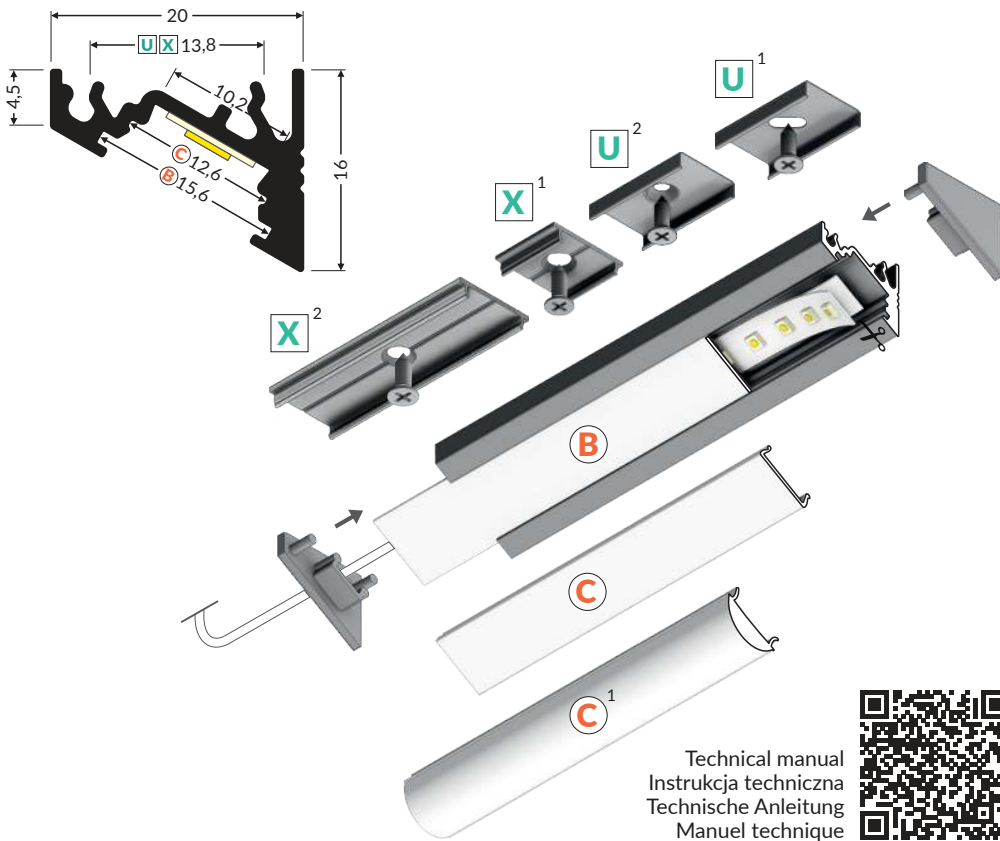

U¹ → 204

mounting plate U
uchwyt U
Halter U
fixation U

U² → 204

mounting plate U cone
uchwyt U cone
Halter U cone
fixation U cône

X¹ → 207

mounting plate X
uchwyt X
Halter X
fixation X

X² → 207

connector X 180 deg
łącznik X 180 st
Verbinder X 180 Grad
connecteur X 180 degrés

B → 194

diffuser B slide
klosz B wsuwany
Abdeckung B einziehbar
diffuseur B coulissant

C → 195

diffuser C click
klosz C klik
Abdeckung C einclipsbar
diffuseur C clic

C¹ → 195

diffuser C click lens gen2
klosz C klik soczewka gen2
Abdeckung C einclipsbar Linse gen2
diffuseur C clic lentille gen 2

white painted biały malowany weiß lackiert peint en blanc	anodized anodowany eloxiert surface anodisée	black anodized czarny anodowany schwarz eloxiert noir anodisé	raw aluminium surowe aluminium Rohaluminium aluminium brut
1000 mm 83040001	83040020	83040021	83040000
2000 mm 83050001	83050020	83050021	83050000
3000 mm 83180001	83180020	83170021	83180000
4050 mm 83190001	83190020	83190021	83190000

end cap CORNER10 gen2
zaślepka CORNER10 gen2
Endkappe CORNER10 gen2
embout CORNER10 gen2



white biały weiß blanc	silver srebrny silbern argent
83990001	83990040

black czarny schwarz noir	grey szary grau gris
83990002	83990022

end cap CORNER10 gen2 with hole
zaślepka CORNER10 gen2 z otworem
Endkappe CORNER10 gen2 mit Öffnung
embout CORNER10 gen2 avec un trou



white biały weiß blanc	silver srebrny silbern argent
83980001	83980040

black czarny schwarz noir	grey szary grau gris
83980002	83980022

connector CORNER10 90 deg
łącznik CORNER10 90 st
Verbinder CORNER10 90 Grad
connecteur CORNER10 90 degrés

material: aluminium
material: aluminium
Material: Aluminium
matériel: aluminium

white painted
biały malowany
weiß lackiert
peint en blanc
83110001

anodized
anodowany
eloxiert
surface anodisée
83110020

black anodized
czarny anodowany
schwarz eloxiert
noir anodisé
83110021

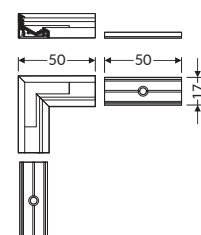

CORNER10.v2 A1C/U1



max 10 mm



corner
kątowy
Eckprofile
d'angles



furniture
meblowe
Möbel-
mobilier

- a new generation of corner profiles
- effective design
- reduced weight (30% lighter than predecessor)
- updated design

- nowa generacja profili kątowych
- efektywna konstrukcja
- zredukowana waga (30% lżejszy od poprzednika)
- odświeżony design

- neue Generation von Eckprofilen
- effektive Konstruktion
- reduziertes Gewicht (30% leichter als Vorgänger)
- aufgefrishtes Design

- nouvelle génération de profilés d'angle
- construction efficace
- poids réduit (30% plus léger de son prédécesseur)
- design rafraîchi



more
information



więcej
szczegółów

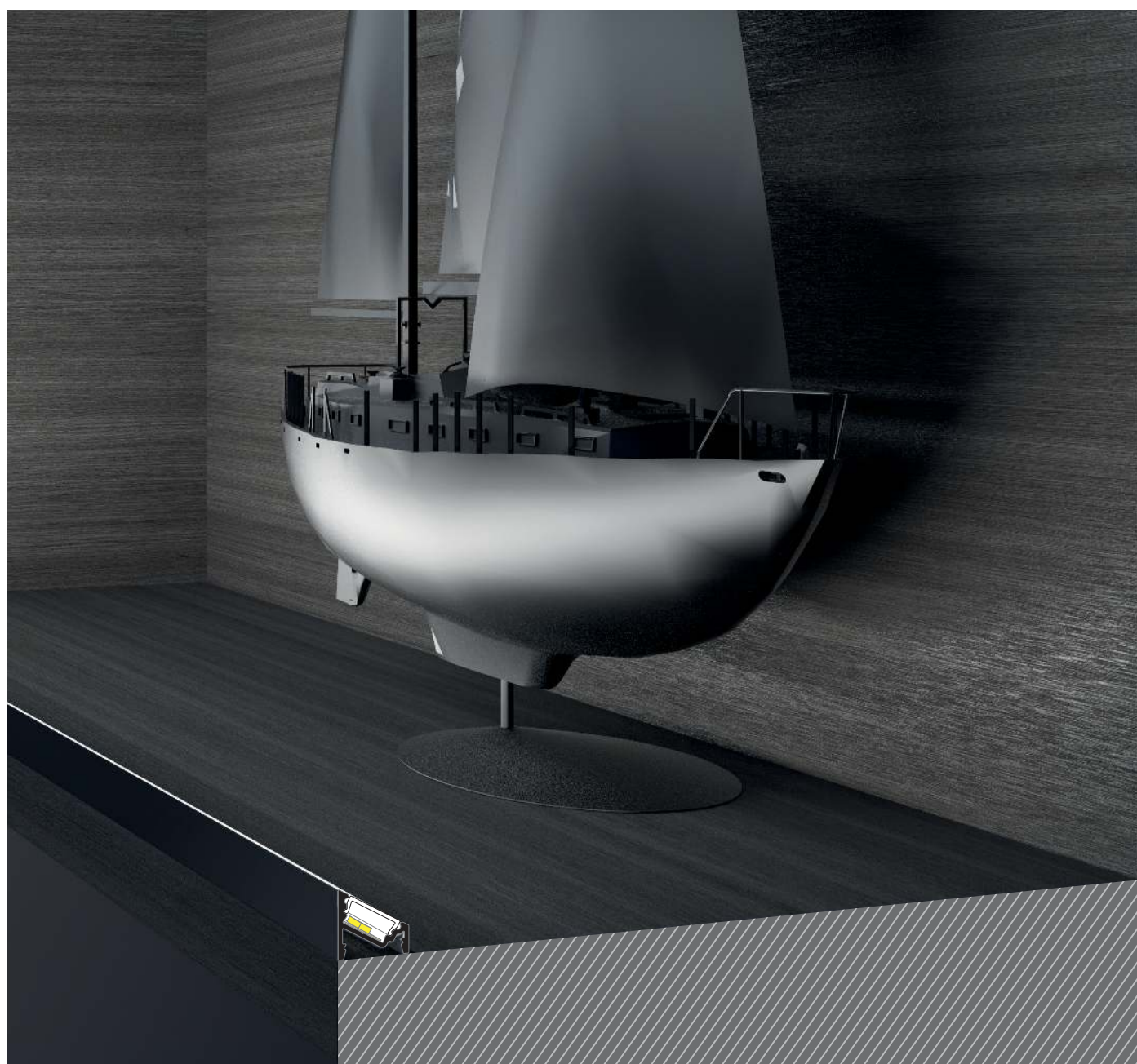

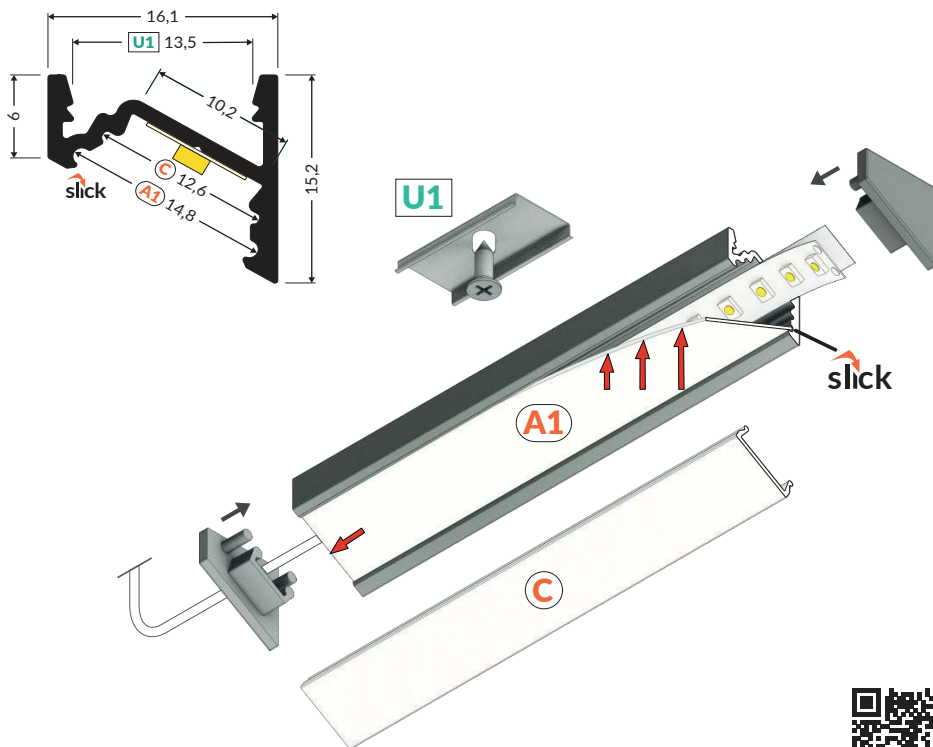

Technical manual
Instrukcja techniczna
Technische Anleitung
Manuel technique

U1 → 205





mounting plate U1
uchwyt U1
Halter U1
fixation U1

A1 → 194

diffuser A1 slide
klosz A1 wsuwany
Abdeckung A1 einschiebbar
diffuseur A1 coulissant

C → 195

diffuser C click
klosz C klik
Abdeckung C einclipsbar
diffuseur C clic

			
white painted biały malowany weiß lackiert peint en blanc	anodized anodowany eloxiert surface anodisée	black anodized czarny anodowany schwarz eloxiert noir anodisé	raw aluminium surowe aluminium Rohaluminium aluminium brut
1000 mm	J6000101	J6000120	J6000100
2000 mm	J6000201	J6000220	J6000200
3000 mm	J6000301	J6000320	J6000300
4050 mm	J6000401	J6000420	J6000400

end cap CORNER10.v2
zaślepka CORNER10.v2
Endkappe CORNER10.v2
embout CORNER10.v2



white biały weiß blanc	silver srebrny silbern argent
J6999901	J6999940

black czarny schwarz noir	grey szary grau gris
J6999902	J6999922

CORNER14 EE7F/TY



max 14mm



corner
kątowy
Eckprofile
d'angles



furniture
meblowe
Möbel-
mobilier

- hidden mounting
- two lighting angles: 30°/60°

- ukryte mocowanie
- dwa kąty świecenia: 30°/60°

- eine versteckte Befestigung
- zwei Beleuchtungswinkel
30° und 60°

- fixation cachée
- deux angles d'éclairage:
30° / 60°



more
information



więcej
szczegółów

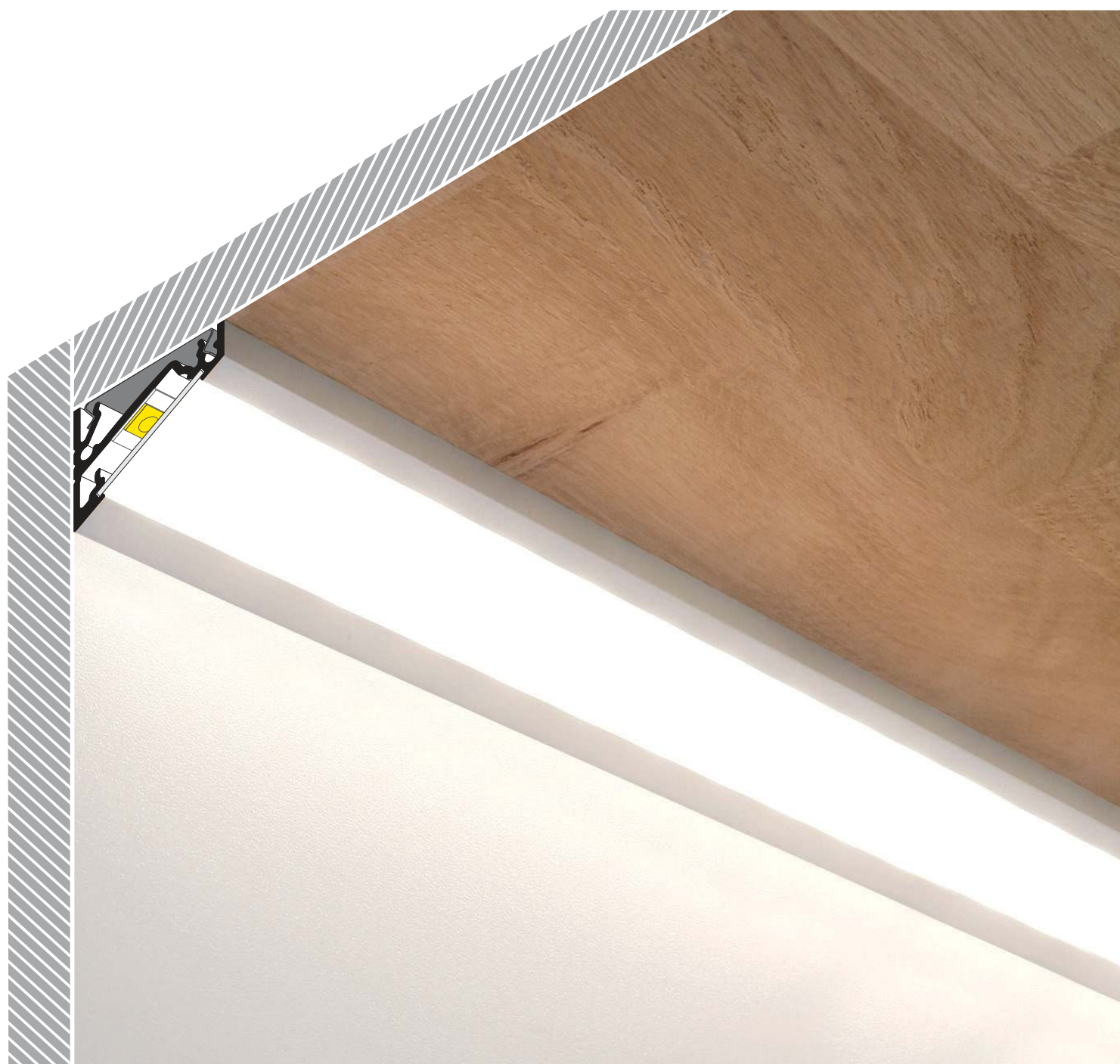

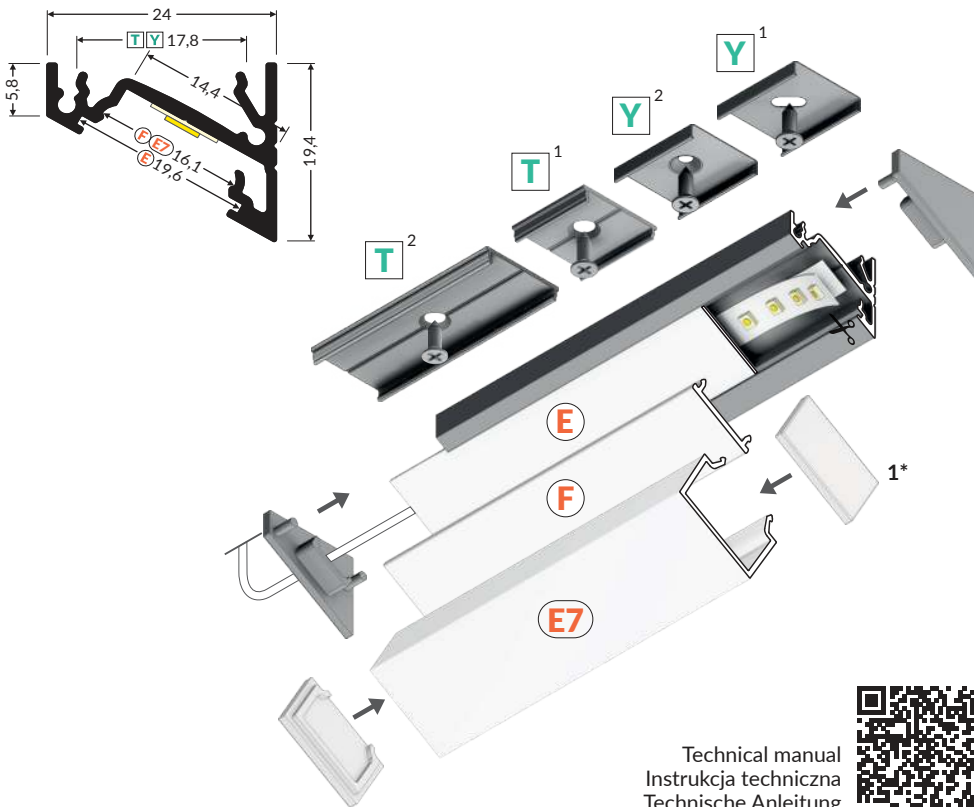

Technical manual
Instrukcja techniczna
Technische Anleitung
Manuel technique



Y¹ → 208

mounting plate Y
uchwyt Y
Halter Y
fixation Y

Y² → 208

mounting plate Y cone
uchwyt Y cone
Halter Y cone
fixation Y cône

T¹ → 204

mounting plate T
uchwyt T
Halter T
fixation T

T² → 204

connector T 180 deg
łącznik T 180 st
Verbinder T 180 Grad
connecteur T 180 degrés

E → 198

diffuser E slide
klosz E wsuwany
Abdeckung E einziehbar
diffuseur E coulissant

F → 199

diffuser F click
klosz F klik
Abdeckung F einclipsbar
diffuseur F clic

E7 → 198

diffuser E7 click
klosz E7 klik
Abdeckung E7 einclipsbar
diffuseur E7 clic

1* → 198

end cap E7
zaślepka E7
Endkappe E7
embout E7

white painted biały malowany weiß lackiert peint en blanc	anodized anodowany eloxiert surface anodisée	black anodized czarny anodowany schwarz eloxiert noir anodisé	raw aluminium surowe aluminium Rohaluminium aluminium brut
1000 mm A4010001	A4010020	A4010021	A4010000
2000 mm A4020001	A4020020	A4020021	A4020000
3000 mm A4100001	A4100020	A4100021	A4100000
4050 mm A4110001	A4110020	A4110021	A4110000

end cap CORNER14 gen2
zaślepka CORNER14 gen2
Endkappe CORNER14 gen2
embout CORNER14 gen2



white
biały
weiß
blanc
A4980001

black
czarny
schwarz
noir
A4980002

silver
srebrny
silbern
argent
A4980040

grey
szary
grau
gris
A4980022

end cap CORNER14 gen2 with hole
zaślepka CORNER14 gen2 z otworem
Endkappe CORNER14 gen2 mit Öffnung
embout CORNER14 gen2 avec un trou



white
biały
weiß
blanc
A4970001

black
czarny
schwarz
noir
A4970002

silver
srebrny
silbern
argent
A4970040

grey
szary
grau
gris
A4970022

connector CORNER14 90 deg
łącznik CORNER14 90 st
Verbinder CORNER14 90 Grad
connecteur CORNER14 90 degrés

white painted
biały malowany
weiß lackiert
peint en blanc
A4990001

anodized
anodowany
eloxiert
surface anodisée
A4990020

black anodized
czarny anodowany
schwarz eloxiert
noir anodisé
A4990021

material: aluminium
material: aluminium
Material: Aluminium
matériel: aluminium

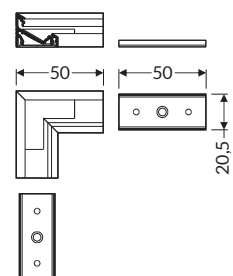

CORNER 12.v2 EF/U



max 12 mm



corner
kątowy
Eckprofile
d'angles



furniture
meblowe
Möbel-
mobilier

- a new generation of angle profiles
- effective design
- reduced weight
- updated design

- nowa generacja profili kątowych
- efektywna konstrukcja
- zredukowana waga
- odświeżony design

- neue Generation von Eckprofilen
- effektive Konstruktion
- reduziertes Gewicht
- aufgefrishtes Design

- nouvelle génération de profilés d'angle
- construction efficace
- poids réduit
- design rafraîchi



more
information



więcej
szczegółów



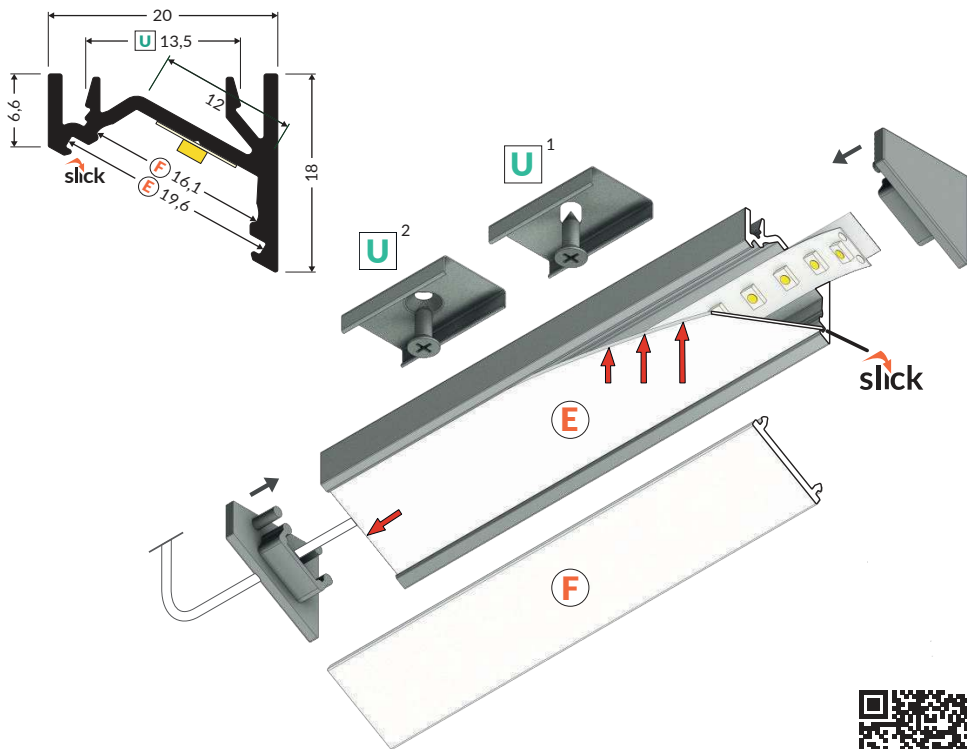

U¹ → 204

mounting plate U
uchwył U
Halter U
fixation U

U² → 204

mounting plate U cone
uchwył U cone
Halter U cone
fixation U cône

E → 198





diffuser E slide
klosz E wsuwany
Abdeckung E einschiebbar
diffuseur E coulissant

F → 199

diffuser F click
klosz F klik
Abdeckung F einclipsbar
diffuseur F clic

Technical manual
Instrukcja techniczna
Technische Anleitung
Manuel technique



			
white painted biały malowany weiß lackiert peint en blanc	anodized anodowany eloxiert surface anodisée	black anodized czarny anodowany schwarz eloxiert noir anodisé	raw aluminium surowe aluminium Rohaluminium aluminium brut
1000 mm	J7000101	J7000120	J7000100
2000 mm	J7000201	J7000220	J7000200
3000 mm	J7000301	J7000320	J7000300
4050 mm	J7000401	J7000420	J7000400

end cap CORNER12.v2
zaślepka CORNER12.v2
Endkappe CORNER12.v2
embout CORNER12.v2

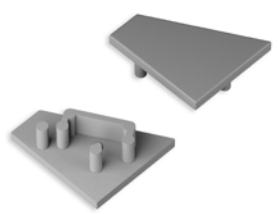

white biały weiß blanc	silver srebrny silbern argent
J7999901	J7999940
black czarny schwarz noir	grey szary grau gris
J7999902	J7999922







**PLASTER-IN
DO SZPACHLOWANIA
ZUM SPACHTELN
POUR LE REMPLISSAGE**





max 10 mm



plaster-in
do szpachlowania
zum Spachteln
pour le remplissage



architectural
architektoniczne
architektonisch
architecture

- decorative lighting, invisible profile and diffuser
- profile for finishing of plasterboards with a minimum thickness of 12,5 mm
- many possible arrangements
- Slick socket

- oświetlenie dekoracyjne, niewidoczny profil i klosz
- profil do wykończenia płyty kartonowo-gipsowej o minimalnej grubości 12,5 mm
- wiele możliwych aranżacji
- gniazdo Slick

- dekorative Beleuchtung, unsichtbares Profil und Abdeckung
- Profil für die Endbearbeitung von Gipskartonplatten mit einer Mindestdicke von 12,5 mm
- viele Gestaltungsmöglichkeiten
- Slick Socket

- éclairage décoratif, profilé et diffuseur invisibles
- profilé pour la finition des cloisons sèches d'une épaisseur minimale de 12,5 mm
- de nombreux aménagements possibles
- prise avec fonction Slick



more information



więcej szczegółów

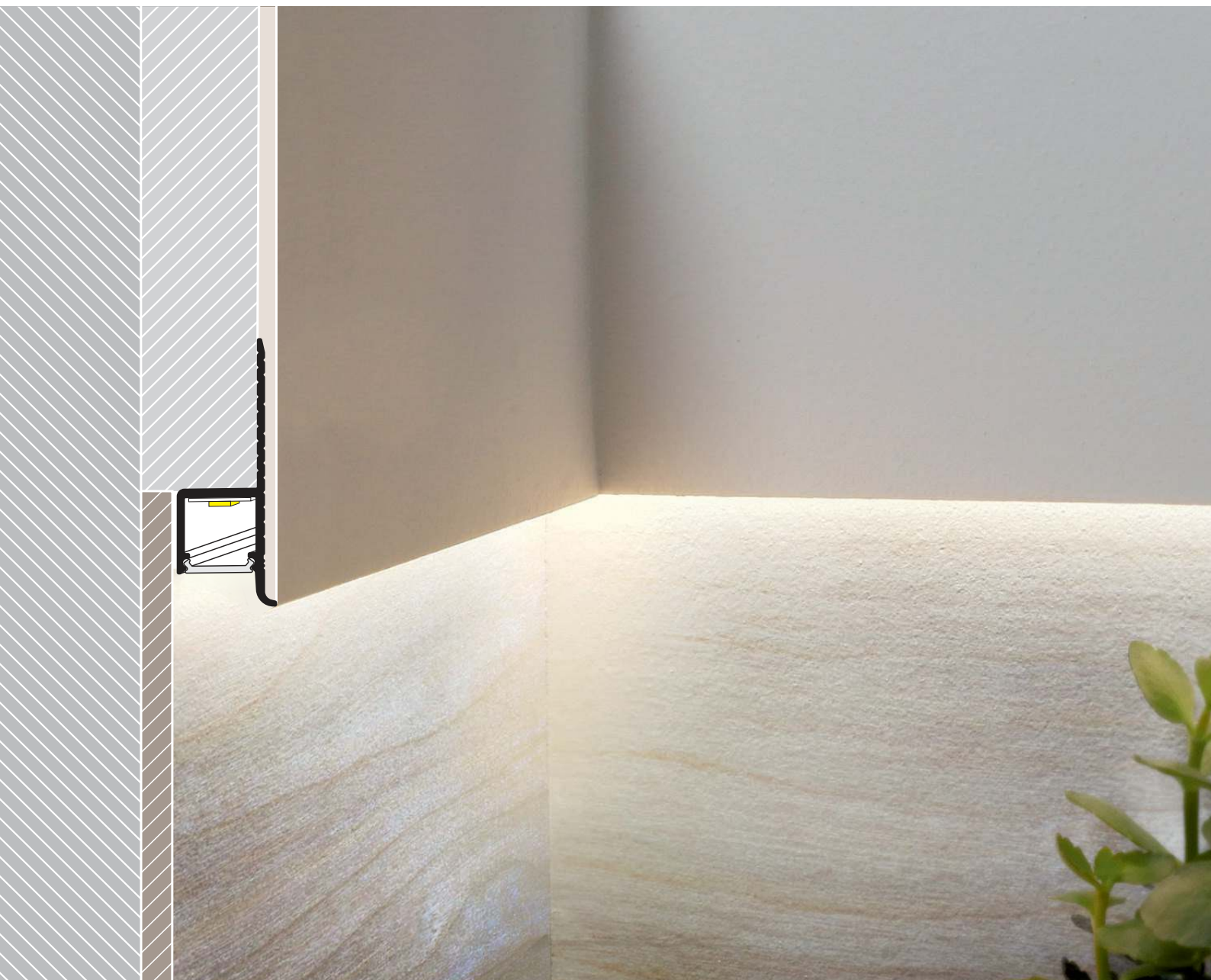

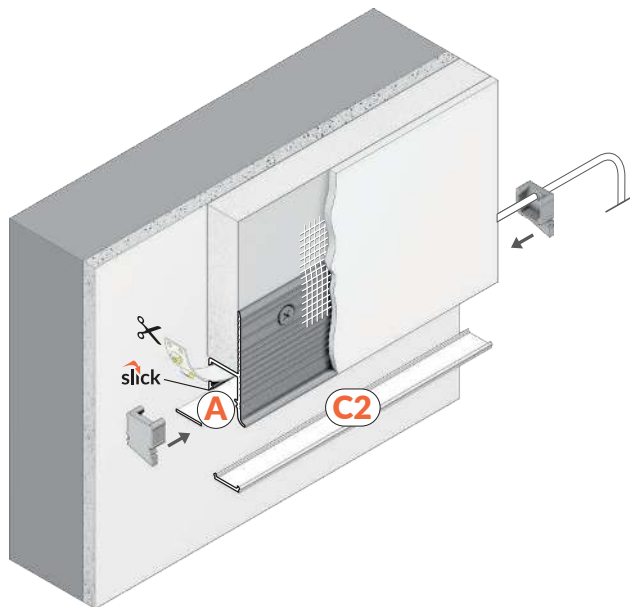
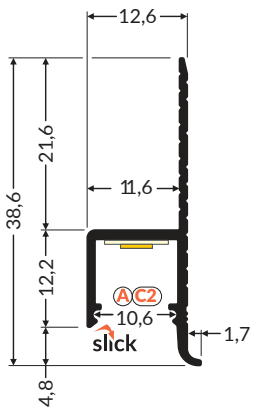

A → 194

diffuser A slide
klosz A wsuwany
Abdeckung A einschiebbar
diffuseur A coulissant

C2 → 196

diffuser C2 click
klosz C2 klik
Abdeckung C2 einclipsbar
diffuseur C2 clic

Technical manual
Instrukcja techniczna
Technische Anleitung
Manuel technique

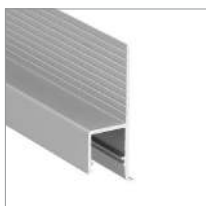

anodized
anodowany
eloxiert
surface anodisée



raw aluminium
surowe aluminium
Rohaluminium
aluminium brut

1000 mm	H4000120	H4000100
2000 mm	H4000220	H4000200
3000 mm	H4000320	H4000300
4050 mm	H4000420	H4000400

end cap OMNI10
zaślepka OMNI10
Endkappe OMNI10
embout OMNI10



grey
szary
grau
gris
H4999922



OMNI10 AC2

EXAMPLES OF POSSIBILITIES
PRZYKŁADOWE MOŻLIWOŚCI
BEISPIELSMÖGLICHKEITEN
EXEMPLES DE POSSIBILITÉS

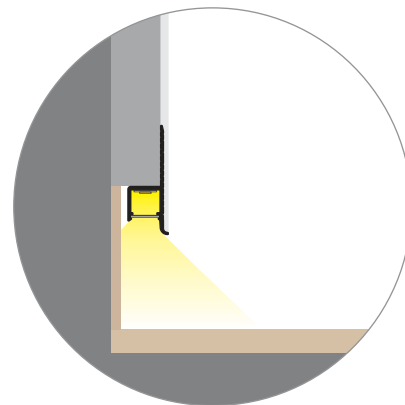
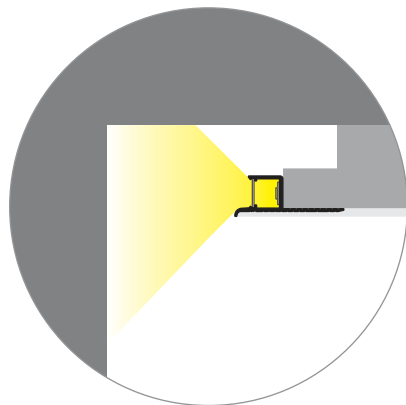
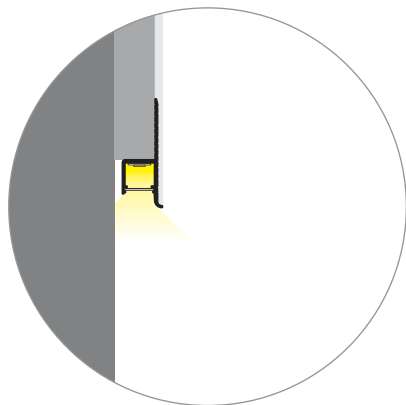

The OMNI10 LED profile can be used in a variety of contexts and it illuminates surfaces with a variety of materials: whether it's a plain painted wall, wallpaper or wooden surfaces.

Profil LED OMNI10 można użyć w różnych kontekstach i oświetlić nim powierzchnie wykończone różnymi materiałami: zarówno gładko pomalowaną ścianę, jak i tapetę czy powierzchnie drewniane.

Das OMNI10 LED Profil kann man in verschiedenen Kontexten einsetzen und damit Oberflächen, die mit unterschiedlichen Materialien fertiggestellt sind, beleuchten: Sowohl glatt gestrichene Wand als auch eine Tapete oder Holzoberflächen.

Le profilé LED OMNI10 peut être utilisé dans divers contextes et illumine les surfaces finies avec divers matériaux; à la fois un mur peint et un papier peint ou des surfaces en bois.

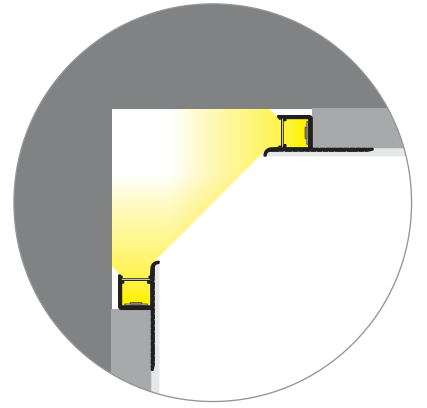
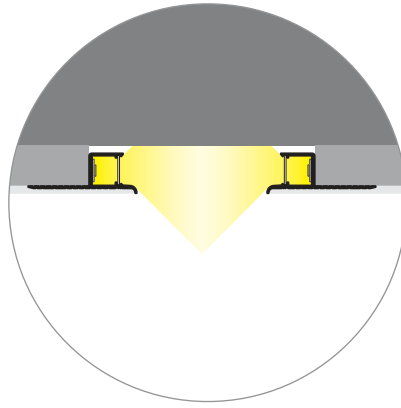
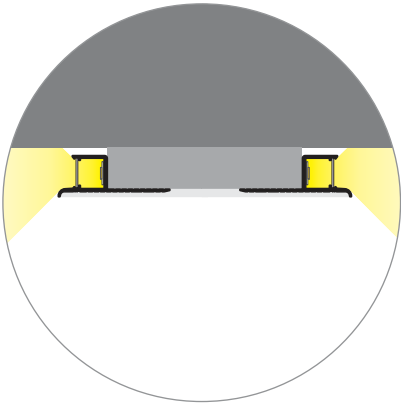

GLOW12 UP A1C



max 12 mm



plaster-in
do szpachlowania
zum Spachteln
pour le remplissage



architectural
architektoniczne
architektonisch
architecture

- for finishing suspended ceilings
- a gentle glow of light on the actual ceiling
- easy and aesthetically pleasing finish to the edges

- do wykańczania sufitów podwieszanych
- delikatna łuna światła na sufit właściwy
- łatwe i estetyczne wykończenie krawędzi sufitu podwieszanego
- do płyty gk o grubości 12,5 mm

- für Fertigstellung von Hängedecken
- sanfter Lichtschimmer auf die eigentliche Decke
- einfache und ästhetische Fertigstellung der Kante von Hängedecke
- für Gipskartonplatten mit einer Dicke von 12,5 mm

- pour la finition des faux plafonds
- douce lueur sur le plafond
- finition facile et esthétique du bord du faux plafond
- pour une plaque de plâtre d'une épaisseur de 12,5 mm

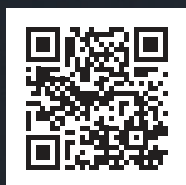
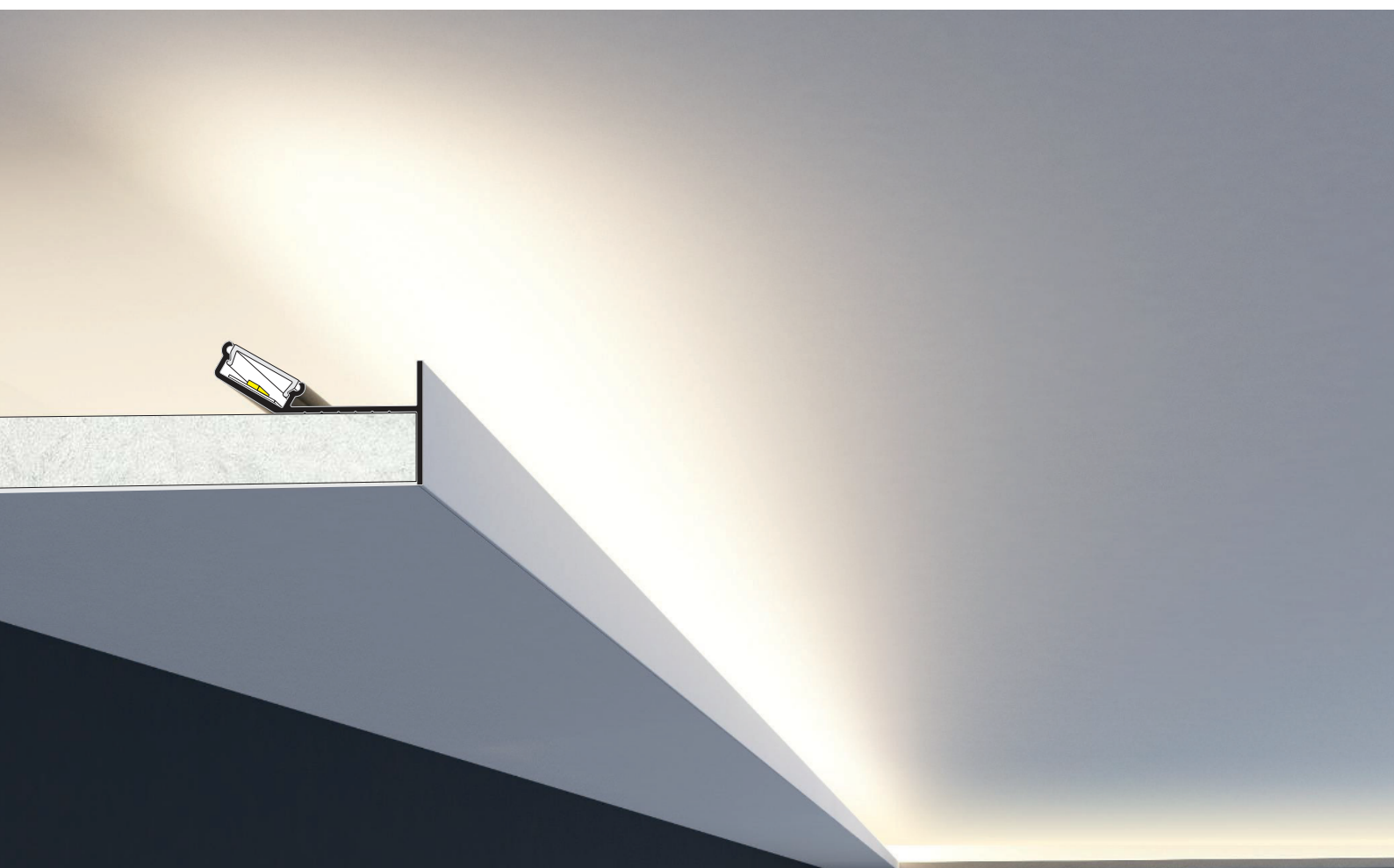

more information

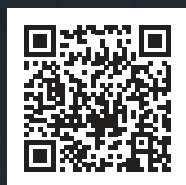

więcej szczegółów

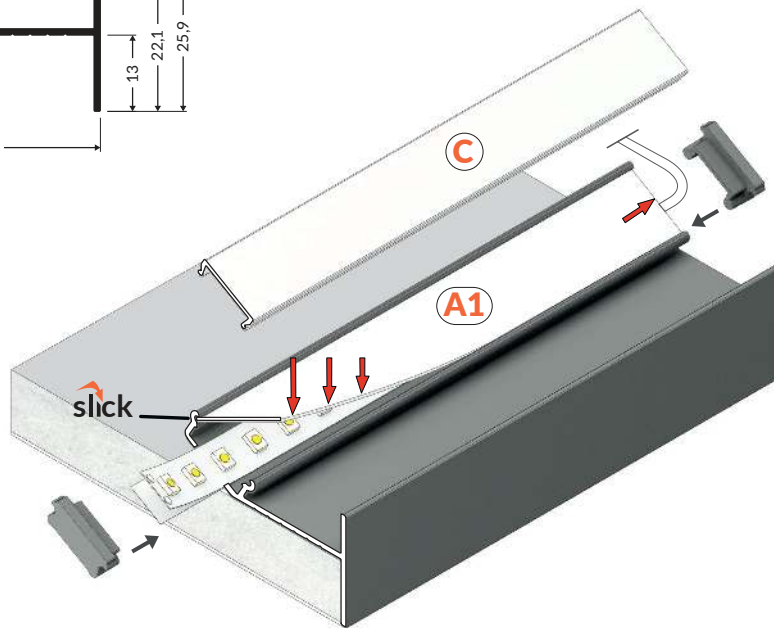
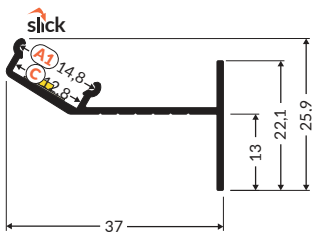

A1 → 194

diffuser A1 slide
klosz A1 wsuwany
Abdeckung A1 einschiebbar
diffuseur A1 coulissant

C → 195

diffuser C click
klosz C klik
Abdeckung C einclipsbar
diffuseur C clic



white painted
biały malowany
weiß lackiert
peint en blanc



anodized
anodowany
eloxiert
surface anodisée



raw aluminium
surowe aluminium
Rohaluminium
aluminium brut

1000 mm	K8000101	K8000120	K8000100
2000 mm	K8000201	K8000220	K8000200
3000 mm	K8000301	K8000320	K8000300
4050 mm	K8000401	K8000420	K8000400

end cap GLOW12
zaślepka GLOW12
Endkappe GLOW12
embout GLOW12

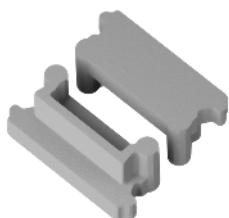

grey
szary
grau
gris
K7999922

GLOW12 DOWN A1C



max 12 mm



plaster-in
do szpachlowania
zum Spachteln
pour le remplissage



architectural
architektoniczne
architektonisch
architecture

- for finishing suspended ceilings
- a gentle glow of light on the wall
- easy and aesthetically pleasing finish to the edges of a suspended ceiling
- for 12.5 mm thick plasterboard

- do wykańczania sufitów podwieszanych
- delikatna łuna światła na ścianę
- łatwe i estetyczne wykończenie krawędzi sufitu podwieszanego
- do płyty gk o grubości 12,5 mm

- für Fertigstellung von Hängedecken
- sanfter Lichtschimmer an der Wand
- einfache und ästhetische Fertigstellung der Kante von Hängedecke
- für Gipskartonplatten mit einer Dicke von 12,5 mm

- pour la finition des faux plafonds
- douce lueur sur le mur
- finition facile et esthétique du bord du faux plafond
- pour une plaque de plâtre d'une épaisseur de 12,5 mm



more information



więcej szczegółów

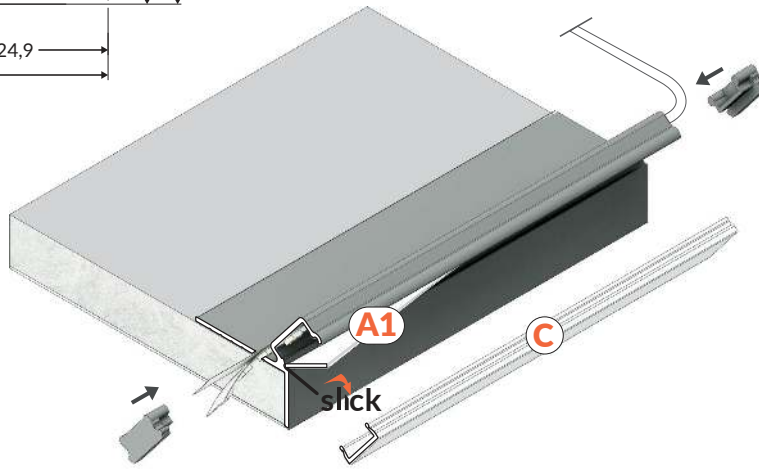
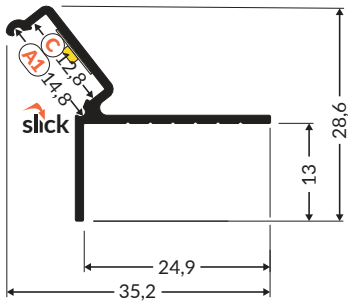

A1 → 194

diffuser A1 slide
klosz A1 wsuwany
Abdeckung A1 einschiebbar
diffuseur A1 coulissant

C → 195

diffuser C click
klosz C klik
Abdeckung C einclipsbar
diffuseur C clic



anodized
anodowany
eloxiert
surface anodisée



raw aluminium
surowe aluminium
Rohaluminium
aluminium brut

1000 mm	K7000120	K7000100
2000 mm	K7000220	K7000200
3000 mm	K7000320	K7000300
4050 mm	K7000420	K7000400

end cap GLOW12
zaślepka GLOW12
Endkappe GLOW12
embout GLOW12

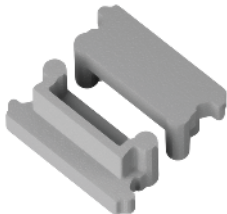

grey
szary
grau
gris
K7999922

FRAME14 BC/Q



max 14 mm



plaster-in
do szpachlowania
zum Spachteln
pour le remplissage



architectural
architektoniczne
architektonisch
architecture

- dedicated for plasterboards - decorative construction finish
- continuous line of light (when using LED strip 120 P/m and opal diffuser)
- multiple arrangements through a variety of connectors

- dedykowany do płyt kartonowo-gipsowych - dekoracyjne wykończenie konstrukcji
- ciągła linia światła (przy zastosowaniu taśmy 120 P/m i klosza mlecznego)
- wiele możliwości aranżacyjnych dzięki różnorodnym łącznikom

- vorgesehen für Rigipsplatten - eine dekorative Ausführung der Konstruktion
- eine homogene Lichtlinie (unter Verwendung von LED Streifen mit 120 leds/m und einer opalen Abdeckung)
- viele Anwendungsmöglichkeiten mit Hilfe von unterschiedlichen Verbindern

- dédié aux plaques de plâtre - finition décorative de la structure
- une ligne continue de lumière (en utilisant un strip 120 P/m et un diffuseur opaque)
- de nombreuses possibilités d'agencement grâce à différents modèles de connecteurs



more
information



więcej
szczegółów

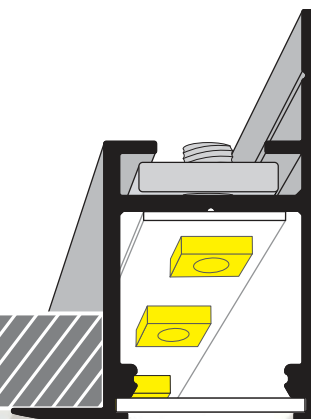

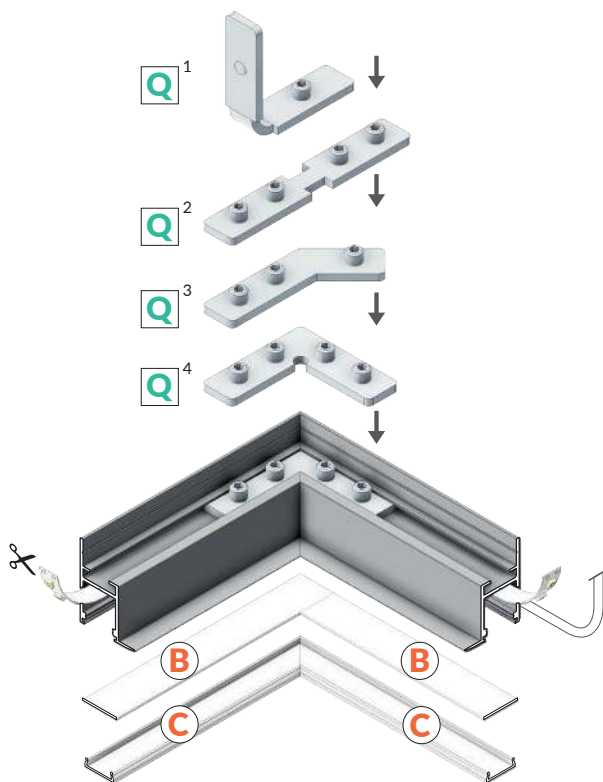
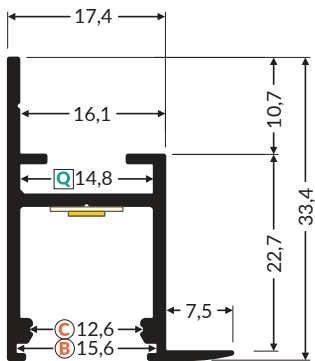

Technical manual
Instrukcja techniczna
Technische Anleitung
Manuel technique

Q¹ → 202

connector Q 90 deg bent
łącznik Q 90 st gięty
Verbinder Q 90 Grad gebogen
connecteur Q 90 degrés plié

Q² → 202

connector Q 180 deg
łącznik Q 180 st
Verbinder Q 180 Grad
connecteur Q 80 degrés

Q³ → 202

connector Q 135 deg
łącznik Q 135 st
Verbinder Q 135 Grad
connecteur Q 135 degrés

Q⁴ → 202

connector Q 90 deg
łącznik Q 90 st
Verbinder Q 90 Grad
connecteur Q 90 degrés

B → 194

diffuser B slide
klosz B wsuwany
Abdeckung B einschiebbar
diffuseur B coulissant

C → 195

diffuser C click
klosz C klik
Abdeckung C einclippsbar
diffuseur C clic



white painted
biały malowany
weiß lackiert
peint en blanc



anodized
anodowany
eloxiert
surface anodisée



raw aluminium
surowe aluminium
Rohaluminium
aluminium brut

1000 mm	C3010001	C3010020	C3010000
2000 mm	C3020001	C3020020	C3020000
3000 mm	C3030001	C3030020	C3030000
4050 mm	C3040001	C3040020	C3040000



SMOOTH12 BC/Q9

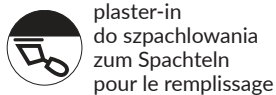

- installation to the wall without a drywall system
- invisible profile, atmospheric light
- accentuating of the room outline

- montaż do zastanej ściany, bez konieczności tworzenia suchej zabudowy
- niewidoczny profil, nastrojowe światło
- akcentowanie obrysów pomieszczenia

- Installation an einer bestehenden Wand ohne Trockenbauarbeiten
- unsichtbares Profil, stimmungsvolles Licht
- Hervorhebung der Raumkontur

- installation sur un mur existant, sans avoir besoin de créer des cloisons sèches
- profilé invisible, lumière ambiante
- accentuant les contours de la pièce



more
information



więcej
szczegółów

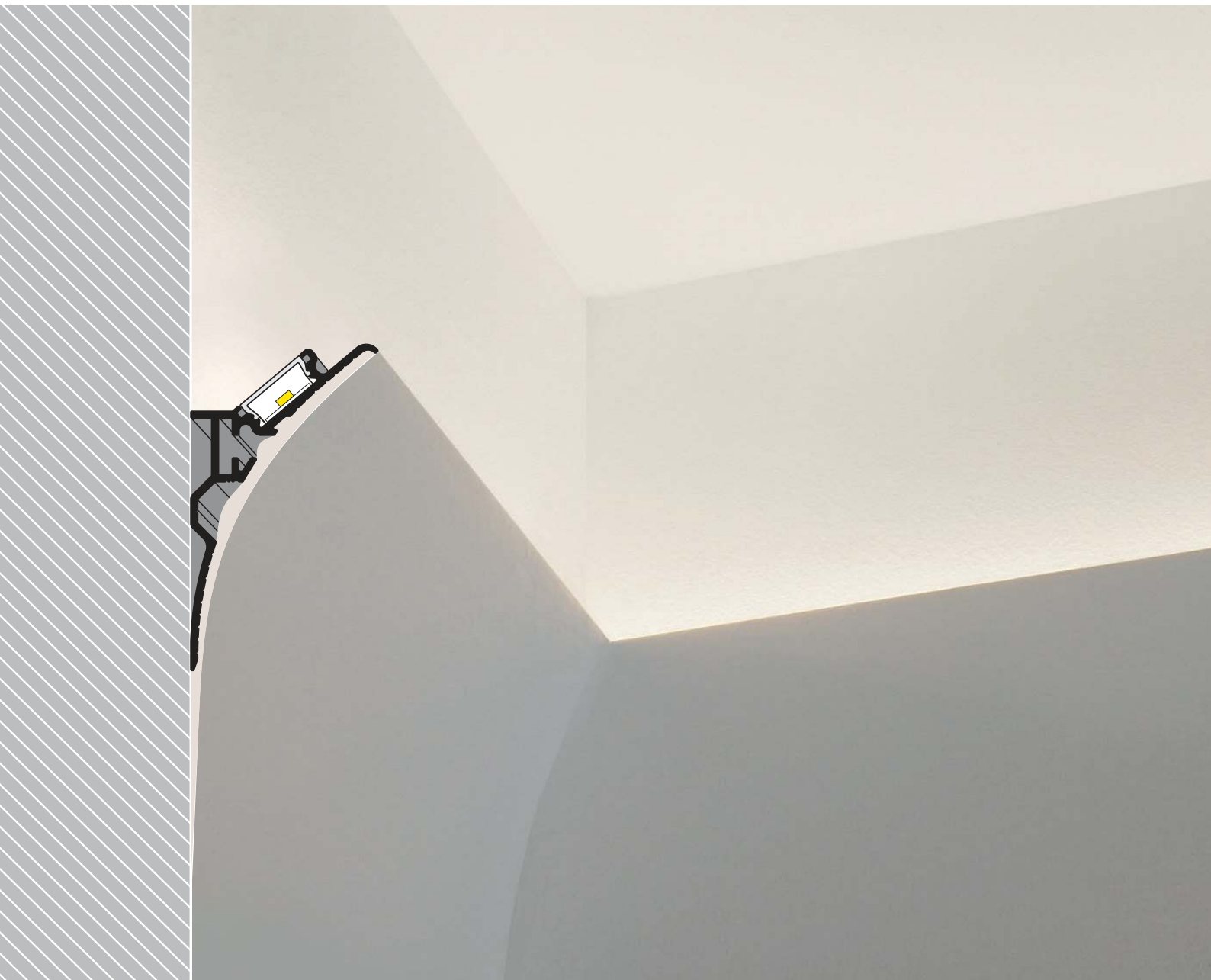

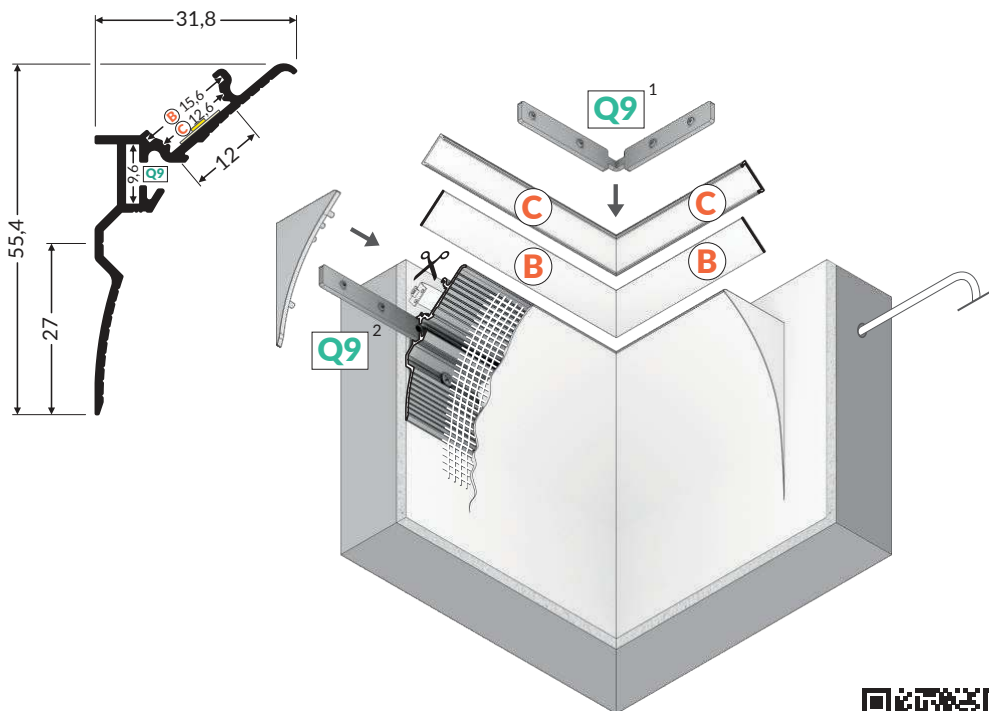

Technical manual
Instrukcja techniczna
Technische Anleitung
Manuel technique



raw aluminium
surowe aluminium
Rohaluminium
aluminium brut

1000 mm	H9000100
2000 mm	H9000200
3000 mm	H9000300
4050 mm	H9000400

end cap SMOOTH12
zaślepka SMOOTH12
Endkappe SMOOTH12
embout SMOOTH12

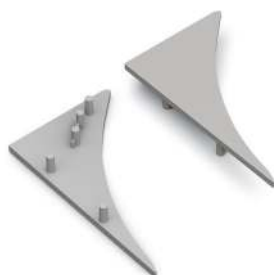

grey
szary
grau
gris
H9999922



Q9¹ → 203

connector Q9 90 deg bent
łącznik Q9 90 st gięty
Verbinder Q9 90 Grad gebogen
connecteur Q9 90 degrés plié

Q9² → 203

connector Q9 180 deg
łącznik Q9 180 st
Verbinder Q9 180 Grad
connecteur Q9 180 degrés

Q9³ → 203

connector Q9 135 deg
łącznik Q9 135 st
Verbinder Q9 135 Grad
connecteur Q9 135 degrés

Q9⁴ → 203

connector Q9 120 deg
łącznik Q9 120 st
Verbinder Q9 120 Grad
connecteur Q9 120 degrés

Q9⁵ → 203

connector Q9 90 deg
łącznik Q9 90 st
Verbinder Q9 90 Grad
connecteur Q9 90 degrés

Q9⁶ → 203

connector Q9 60 deg
łącznik Q9 60 st
Verbinder Q9 60 Grad
connecteur Q9 60 degrés

Q9⁷ → 203

connector Q9 45 deg
łącznik Q9 45 st
Verbinder Q9 45 Grad
connecteur Q9 45 degrés

B → 194

diffuser B slide
klosz B wsuwany
Abdeckung B einziehbar
diffuseur B coulissant

C → 195

diffuser C click
klosz C klik
Abdeckung C einclippsbar
diffuseur C clic

HIDE10 C4

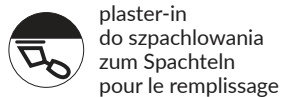

- profile that fits into the thickness of a standard plasterboard (12,5 mm)
- continuous line of light when using LED strip 120 P/m

- profil mieszczący się w grubości standardowej płyty kartonowo-gipsowej (12,5 mm)
- ciągła linia światła przy użyciu taśmy 120 P/m

- Profil, das in die Dicke einer Standard-Rigipsplatte passt (12,5 mm)
- homogene Lichtlinie unter Verwendung vom 120 P/m Band

- le profil correspond à l'épaisseur d'une cloison sèche standard (12,5 mm)
- ligne continue de lumière utilisant un ruban LED 120 P/M.



more
information



więcej
szczegółów



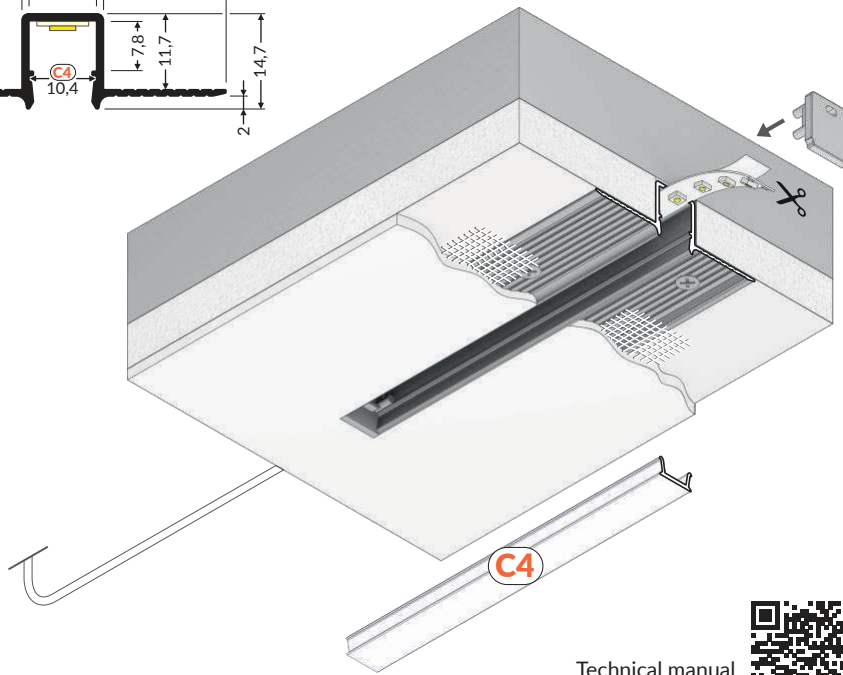
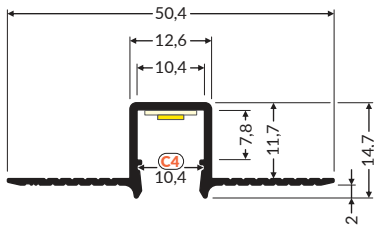

Technical manual
Instrukcja techniczna
Technische Anleitung
Manuel technique



C4 → 196

diffuser C4 click
klosz C4 klik
Abdeckung C4 einclipsbar
diffuseur C4 clic

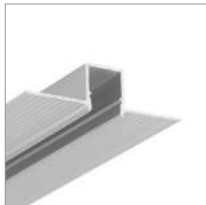

anodized
anodowany
eloxiert
surface anodisée

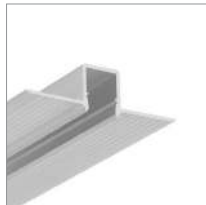

raw aluminium
surowe aluminium
Rohaluminium
aluminium brut

1000 mm	H7000120	H7000100
2000 mm	H7000220	H7000200
3000 mm	H7000320	H7000300
4050 mm	H7000420	H7000400

end cap HIDE10 with hole
zaślepka HIDE10 z otworem
Endkappe HIDE10 mit Öffnung
embout HIDE10 avec un trou



grey
szary
grau
gris
H7999922



LINEA-IN20 TRIMLESS EE7F

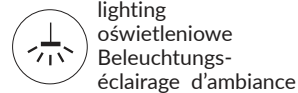
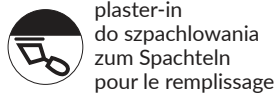

- for spackle flange mounting
- Slick socket - easy assembly technology
- continuous line of light (when using LED strip 120 P/m and opal diffuser)

- do zabudowy szpachlowej
- gniazdo Slick - prosty montaż klosza
- ciągła linia światła (przy użyciu taśmy 120 P/m oraz klosza mlecznego)

- für Spachteltechnik
- Slick Socket - einfache Montage der Abdeckung
- eine homogene Lichtlinie (beim Gebrauch eines LED Streifens mit 120 P/m und einer opalen Abdeckung)

- pour le plâtrage
- Prise avec fonction Slick - installation simple de diffuseur
- une ligne continue de lumière (à l'aide de strip 120 P/m et de diffuseur opaque)



more information



więcej szczegółów

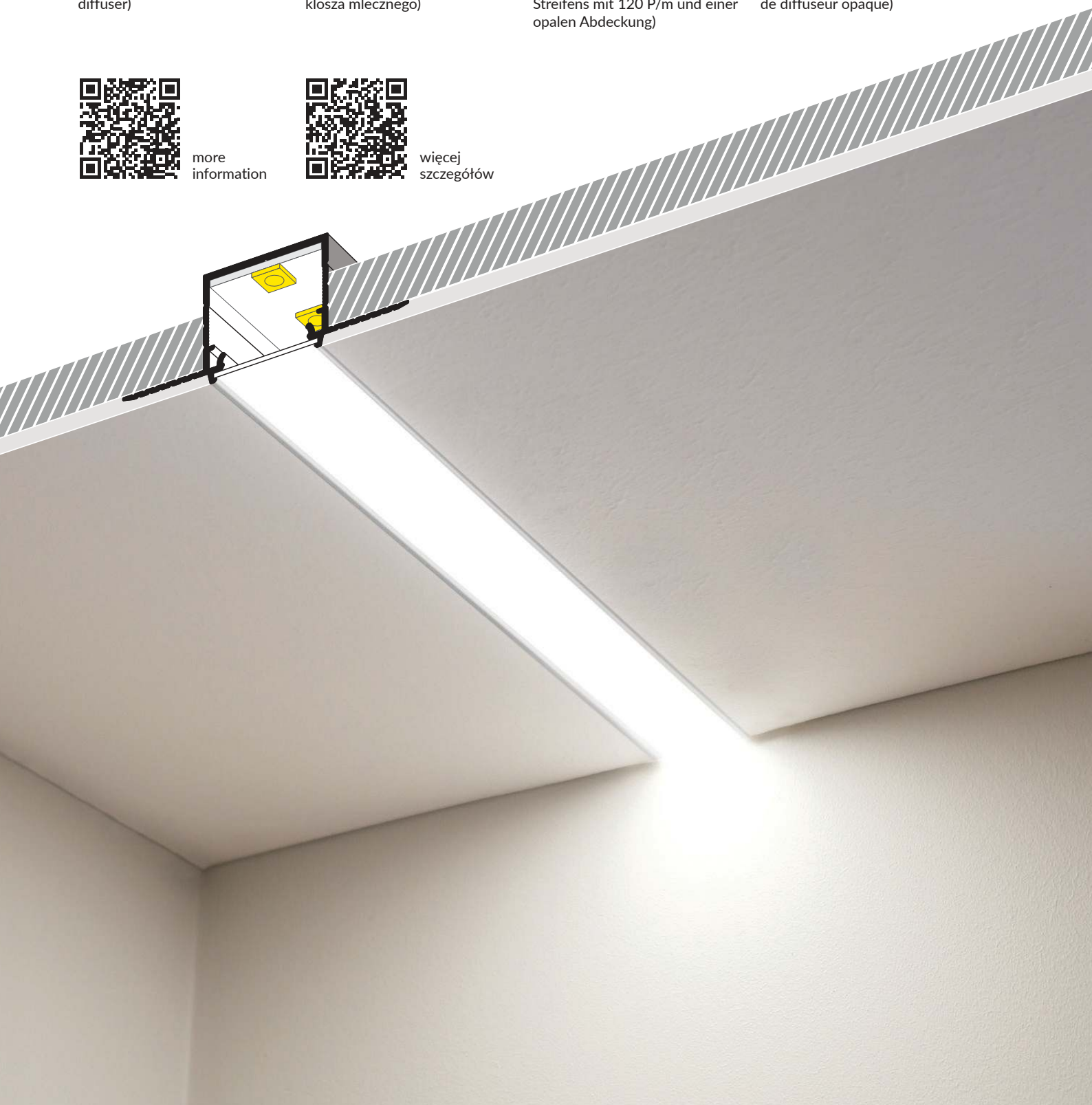

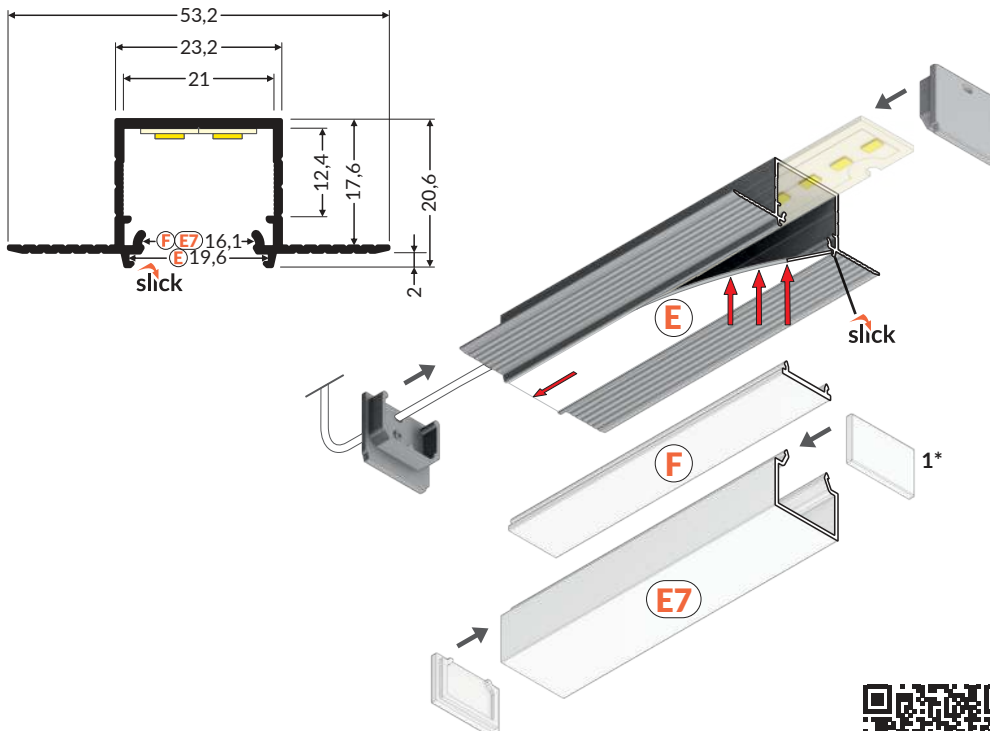

E → 198

diffuser E slide
klosz E wsuwany
Abdeckung E einschiebbar
diffuseur E coulissant

F → 199

diffuser F click
klosz F klik
Abdeckung F einclipsbar
diffuseur F clic

E7 → 198

diffuser E7 click
klosz E7 klik
Abdeckung E7 einclipsbar
diffuseur E7 clic

1* → 198

end cap E7
zaślepka E7
Endkappe E7
embout E7

Technical manual
Instrukcja techniczna
Technische Anleitung
Manuel technique

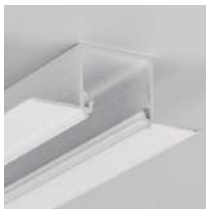

white painted
biały malowany
weiß lackiert
peint en blanc



anodized
anodowany
eloxiert
surface anodisée



raw aluminium
surowe aluminium
Rohaluminium
aluminium brut

1000 mm	G1000101	G1000120	G1000100
2000 mm	G1000201	G1000220	G1000200
3000 mm	G1000301	G1000320	G1000300
4050 mm	G1000401	G1000420	G1000400

end cap LINEA-IN20 TRIMLESS with hole
zaślepka LINEA-IN20 TRIMLESS z otworem
Endkappe LINEA-IN20 TRIMLESS mit Öffnung
embout LINEA-IN20 TRIMLESS avec un trou



white silver
biały srebrny
weiß silbern
blanc argent
G1000501 **G1000540**

grey
szary
grau
gris
G1000522

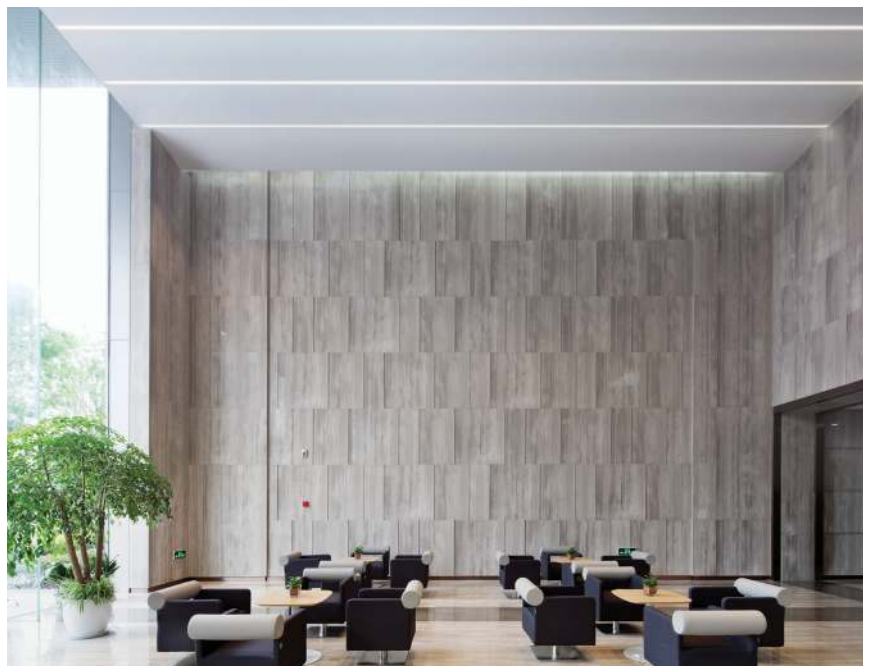

VARIO30-04, 05 ACDE-9



max 30 mm



plaster-in
do szpachlowania
zum Spachteln
pour le remplissage



architectural
architektoniczne
architektonisch
architecture



lighting
oświetleniowe
Beleuchtungs-
éclairage d'ambiance

- part of a larger system for luminaire construction
- continuous line of light in angled connections
- unlimited possibilities for light creation

- system do tworzenia różnorodnych kombinacji
- ciągła linia światła w połączeniach kątowych
- nieograniczone możliwości kreowania światła

- System für die Bildung verschiedener Kombinationen
- homogene Lichtlinie in Eckverbindungen
- unbegrenzte Möglichkeiten der Lichtgestaltung

- un élément d'un très vaste système pour la construction de luminaires
- une ligne lumineuse permanente dans les connecteurs angulaires
- des possibilités illimitées concernant la création de lumière

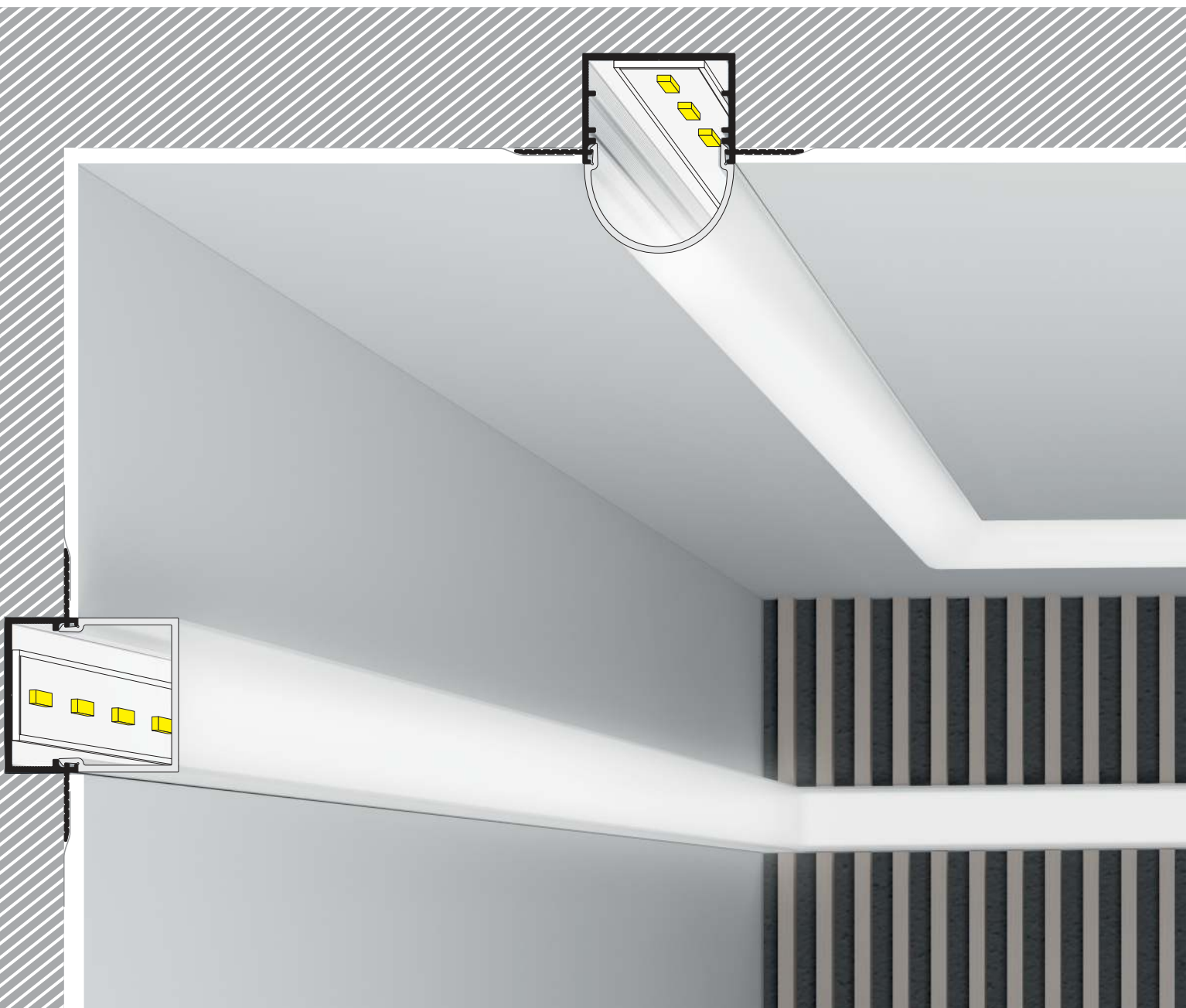

VARIO30-04
ACDE-9

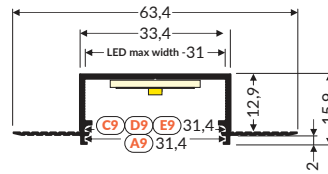
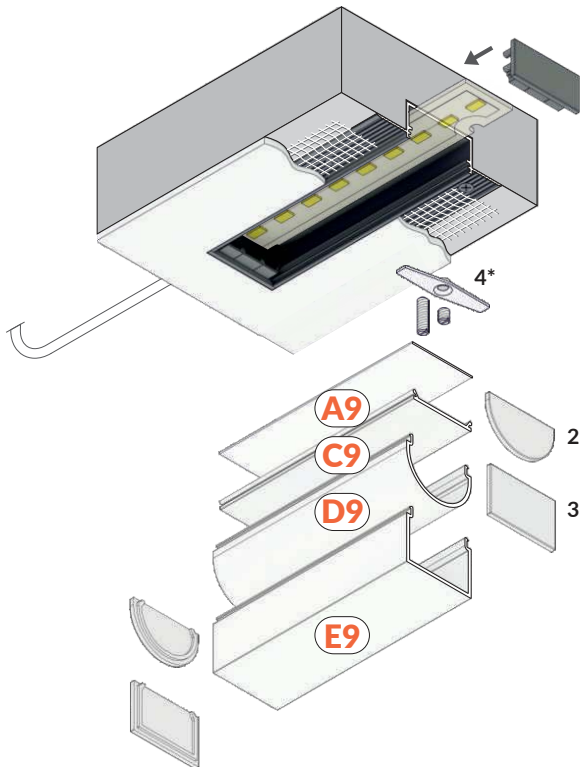

A9 → 194

diffuser A9 slide
klosz A9 wsuwany
Abdeckung A9 einschiebbar
diffuseur A9 coulissant

C9 → 197

diffuser C9 click
klosz C9 klik
Abdeckung C9 einclipsbar
diffuseur C9 clic

D9 → 198

diffuser D9 click
klosz D9 klik
Abdeckung D9 einclipsbar
diffuseur D9 clic

E9 → 199

diffuser E9 click
klosz E9 klik
Abdeckung E9 einclipsbar
diffuseur E9 clic



more information



więcej szczegółów



Technical manual
Instrukcja techniczna
Technische Anleitung
Manuel technique

2* → 198

end cap D9
zaślepka D9
Endkappe D9
embout D9

3* → 199

end cap E9
zaślepka E9
Endkappe E9
embout E9

4* → 210

LED clamp VARIO30
docisk LED VARIO30
LED Klemme VARIO30
clip de fixation LED VARIO30



white painted
biały malowany
weiß lackiert
peint en blanc



anodized
anodowany
eloxiert
surface anodisée



raw aluminium
surowe aluminium
Rohaluminium
aluminium brut

1000 mm	V3130001	V3130020	V3130000
2000 mm	V3140001	V3140020	V3140000
3000 mm	V3150001	V3150020	V3150000
4050 mm	V3160001	V3160020	V3160000

end cap VARIO30-04
zaślepka VARIO30-04
Endkappe VARIO30-04
embout VARIO30-04



white
biały
weiß
blanc
V4900001

silver
srebrny
silbern
argent
V4900040

grey
szary
grau
gris
V4900022



VARIO30-05
ACDE-9

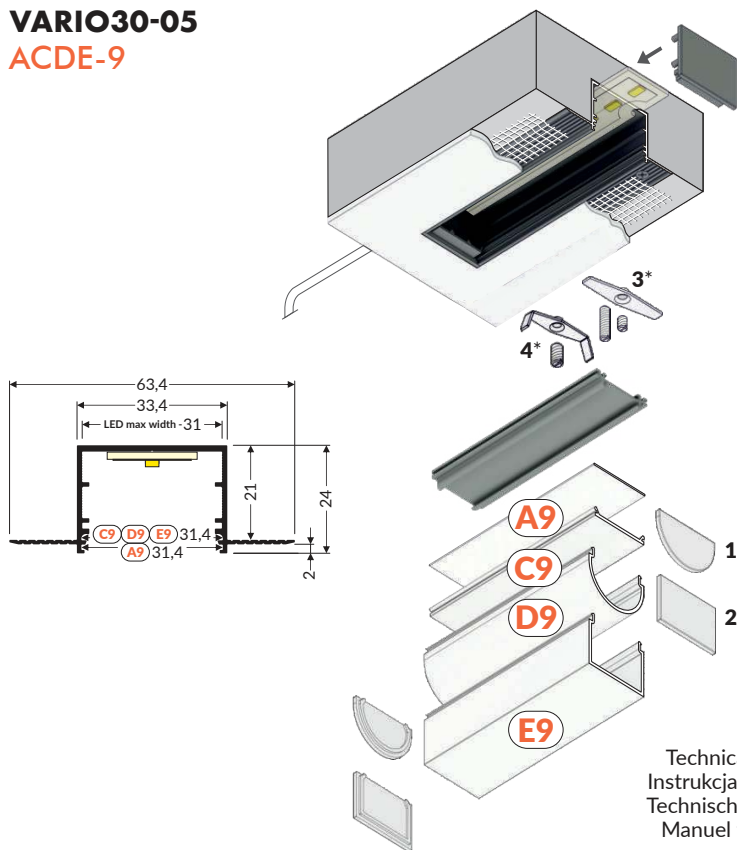

Technical manual
Instrukcja techniczna
Technische Anleitung
Manuel technique



more
information



więcej
szczegółów



A9 → 194

diffuser A9 slide
klosz A9 wsuwany
Abdeckung A9 einschiebbar
diffuseur A9 coulissant

C9 → 197

diffuser C9 click
klosz C9 klik
Abdeckung C9 einclipsbar
diffuseur C9 clic

D9 → 198

diffuser D9 click
klosz D9 klik
Abdeckung D9 einclipsbar
diffuseur D9 clic

E9 → 199

diffuser E9 click
klosz E9 klik
Abdeckung E9 einclipsbar
diffuseur E9 clic

1* → 198

end cap D9
zaślepka D9
Endkappe D9
embout D9

2* → 199



end cap E9
zaślepka E9
Endkappe E9
embout E9

3* → 210

LED clamp VARIO30
docisk LED VARIO30
LED Klemme VARIO30
clip de fixation LED VARIO30

4* → 210

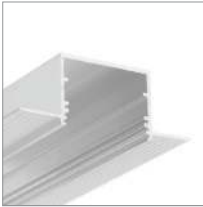
LED clamp VARIO30-1
docisk LED VARIO30-1
LED Klemme VARIO30-1
clip de fixation LED VARIO30-1

			
	white painted biały malowany weiß lackiert peint en blanc	anodized anodowany eloxiert surface anodisée	raw aluminium surowe aluminium Rohaluminium aluminium brut
1000 mm	V3170001	V3170020	V3170000
2000 mm	V3180001	V3180020	V3180000
3000 mm	V3190001	V3190020	V3190000
4050 mm	V3200001	V3200020	V3200000

end cap VARIO30-05
zaślepka VARIO30-05
Endkappe VARIO30-05
embout VARIO30-05

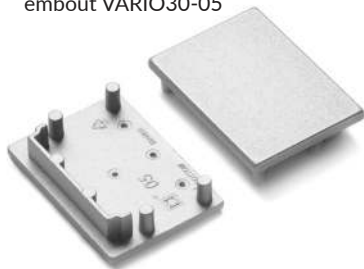

white biały weiß blanc	silver srebrny silbern argent
V4910001	V4910040

grey
szary
grau
gris
V4910022

CONNECTORS ŁĄCZNIKI VERBINDER CONNECTEURS

material: aluminium, polycarbonate
 materiał: aluminium, poliwęglan
 Material: Aluminium, Polycarbonat
 matériel: aluminium, polycarbonate

connector VARIO30-05 60 deg
 łącznik VARIO30-05 60 st
 Verbinder VARIO30-05 60 Grad
 connecteur VARIO30-05 60 degrés

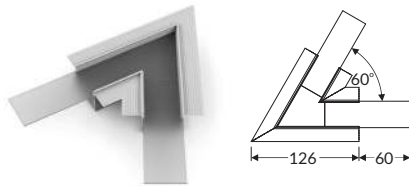

white painted
 biały malowany
 weiß lackiert
 peint en blanc
V4720001S

anodized
 anodowany
 eloxiert
 surface anodisée
V4720020S

connector VARIO30-05 90 deg
 łącznik VARIO30-05 90 st
 Verbinder VARIO30-05 90 Grad
 connecteur VARIO30-05 90 degrés

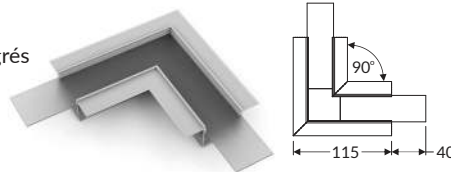

white painted
 biały malowany
 weiß lackiert
 peint en blanc
V4730001S

anodized
 anodowany
 eloxiert
 surface anodisée
V4730020S

connector VARIO30-05 90 deg bent
 łącznik VARIO30-05 90 st gięty
 Verbinder VARIO30-05 90 Grad gebogen
 connecteur VARIO30-05 90 degrés plié

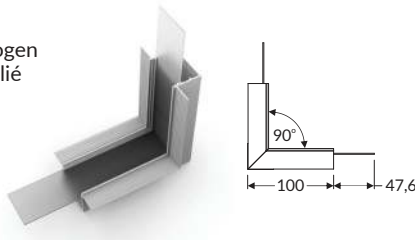

white painted
 biały malowany
 weiß lackiert
 peint en blanc
V4740001S

anodized
 anodowany
 eloxiert
 surface anodisée
V4740020S

connector VARIO30-05 120 deg
 łącznik VARIO30-05 120 st
 Verbinder VARIO30-05 120 Grad
 connecteur VARIO30-05 120 degrés

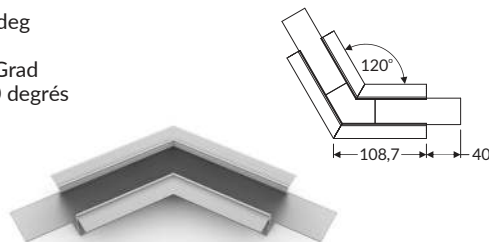

white painted
 biały malowany
 weiß lackiert
 peint en blanc
V4750001S

anodized
 anodowany
 eloxiert
 surface anodisée
V4750020S

connector VARIO30-05 135 deg
 łącznik VARIO30-05 135 st
 Verbinder VARIO30-05 135 Grad
 connecteur VARIO30-05 135 degrés

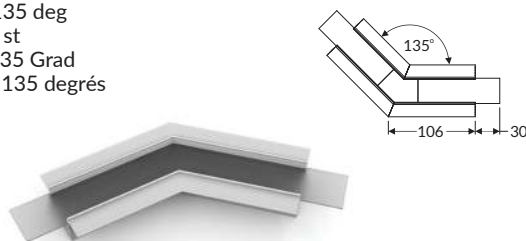

white painted
 biały malowany
 weiß lackiert
 peint en blanc
V4760001S

anodized
 anodowany
 eloxiert
 surface anodisée
V4760020S

connector VARIO30-05 180 deg
 łącznik VARIO30-05 180 st
 Verbinder VARIO30-05 180 Grad
 connecteur VARIO30-05 180 degrés



V4610000S

connector VARIO30-05 270 deg bent
 łącznik VARIO30-05 270 st gięty
 Verbinder VARIO30-05 270 Grad gebogen
 connecteur VARIO30-05 270 degrés plié

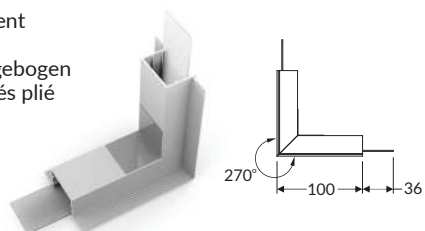

white painted
 biały malowany
 weiß lackiert
 peint en blanc
V4770001S

anodized
 anodowany
 eloxiert
 surface anodisée
V4770020S



**TILE-IN
DO PŁYTEK
FÜR FLIESEN
POUR LES CARREAUX**



FLOOR8 K



max 8 mm



tile-in
do płytek
für Fliesen
pour les carreaux



architectural
architektoniczne
architektonisch
pour le batiment



240
P/m

for continuous line of light
dla ciągłej linii światła
für homogenes Licht
pour une ligne de lumière continue

- recessed floor profile
- high abrasion resistance, resistant diffuser
- possibility of waterproof
- with high humidity, please use waterproof tape outline
- optimal height for installation in standard tiles or floor panels

- profil wpustowy do podłóg
- wysoka odporność na ścieranie, wytrzymały klosz
- możliwość uzyskania wodoszczelności
- przy podwyższonej wilgotności stosować taśmę wodoodporną
- optymalna wysokość do montażu w standardowych płytkach lub panelach podłogowych

- Einbauprofile für Böden
- eine hohe Beständigkeit gegen Abwischbarkeit, eine widerstandsfähige Abdeckung
- Möglichkeit des Erreichens von Wasserbeständigkeit
- bei einer erhöhten Feuchtigkeit soll man einen wasserdichten LED Streifen verwenden
- optimale Höhe für den Einbau in Standardfliesen oder Fussbodenpanelen

- profilés à encastrer pour les sols
- haute résistance à l'abrasion, diffuseur durable
- la possibilité d'obtenir une étanchéité
- en cas d'humidité accrue, utilisez un ruban LED étanche
- hauteur optimale pour l'installation dans des carreaux ou des panneaux de sol standard



more
information



więcej
szczegółów



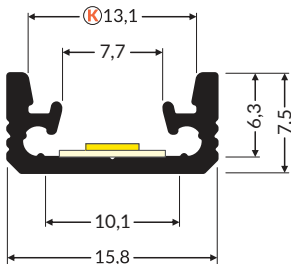

In high humidity conditions
use waterproof LED strip and silicone seal
Przy podwyższonej wilgotności
zaleca się użycie zestawu uszczelniającego
i wodoodpornej taśmy
Bei hoher Feuchtigkeit wasserdichtes Band
und Silikondichtung verwenden
Dans des conditions d'humidité élevée
il faut utiliser un ruban LED étanche et un joint
en silicone

K → 200

diffuser K click
klosz K klik
Abdeckung K einclipsbar
diffuseur K clic

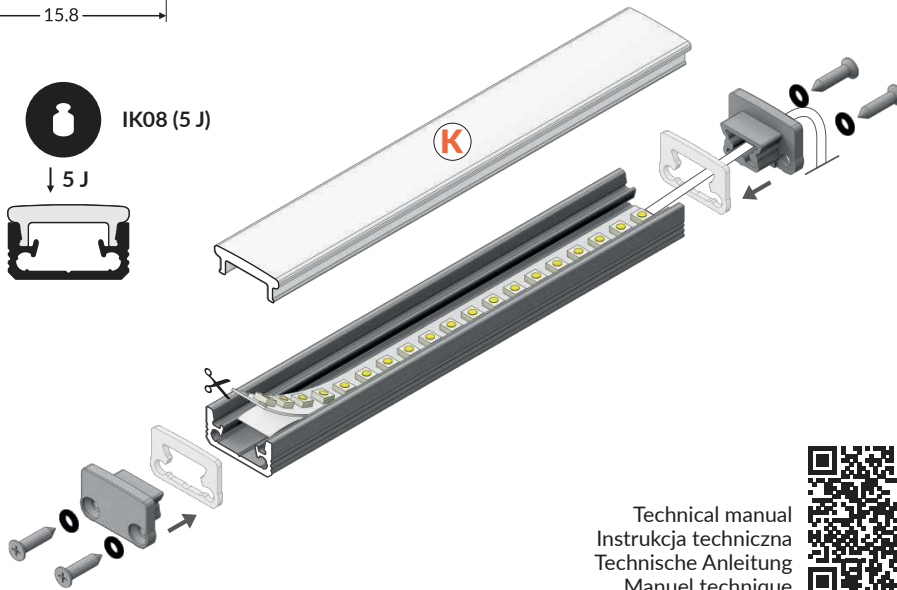
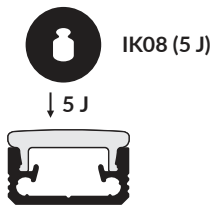

Technical manual
Instrukcja techniczna
Technische Anleitung
Manuel technique



anodized
anodowany
eloxiert
surface anodisée

1000 mm	G6000120
2000 mm	G6000220
3000 mm	G6000320
4050 mm	G6000420

end cap FLOOR8
zaślepka FLOOR8
Endkappe FLOOR8
embout FLOOR8



sealings for FLOOR8 end caps
2x silicone sealings,
4x rubber o-ring
uszczelki do zaślepki FLOOR8
2x silikonowa uszczelka
4x gumowa uszczelka o-ring
Dichtungen für Endkappe
2x Silikon-Dichtungen
4x Gummi O-Ring
joints pour le embout
2x joint en silicone
4x joint torique en caoutchouc

silver
srebrny
silbern
argent
G6999940

grey
szary
grau
gris
G6999922



G69998005



FLOOR12 K/U



max 12 mm



tile-in
do płytek
für Fliesen
pour les carreaux



architectural
architektoniczne
architektonische
pour le bâtiment



120
P/m

for continuous line of light
dla ciągłej linii światła
für homogenes Licht
pour une ligne de lumière continue

- recessed floor profile
- high abrasion resistance, resistant diffuser
- possibility of waterproof
- with high humidity, please use waterproof tape outline
- the perfect solution for application in thicker floor materials

- profil wpustowy do podłóg
- wysoka odporność na ścieranie, wytrzymały klosz
- możliwość uzyskania wodoszczelności
- przy podwyższonej wilgotności stosować taśmę wodoodporną
- rozwiązanie idealne do stosowania w grubszych materiałach podłogowych

- Einbauprofil für Böden
- eine hohe Beständigkeit gegen Abwischbarkeit, eine widerstandsfähige Abdeckung
- Möglichkeit des Erreichens von Wasserbeständigkeit
- bei einer erhöhten Feuchtigkeit soll man einen wasserdichten LED Streifen verwenden
- Die ideale Lösung zur Verwendung in dickeren Fussbodenmaterialien

- profilés à encastrer pour les sols
- haute résistance à l'abrasion, diffuseur durable
- la possibilité d'obtenir une étanchéité
- en cas d'humidité accrue, utilisez un ruban LED étanche
- idéal pour une utilisation dans des matériaux de revêtement de sol plus épais



more
information



więcej
szczegółów

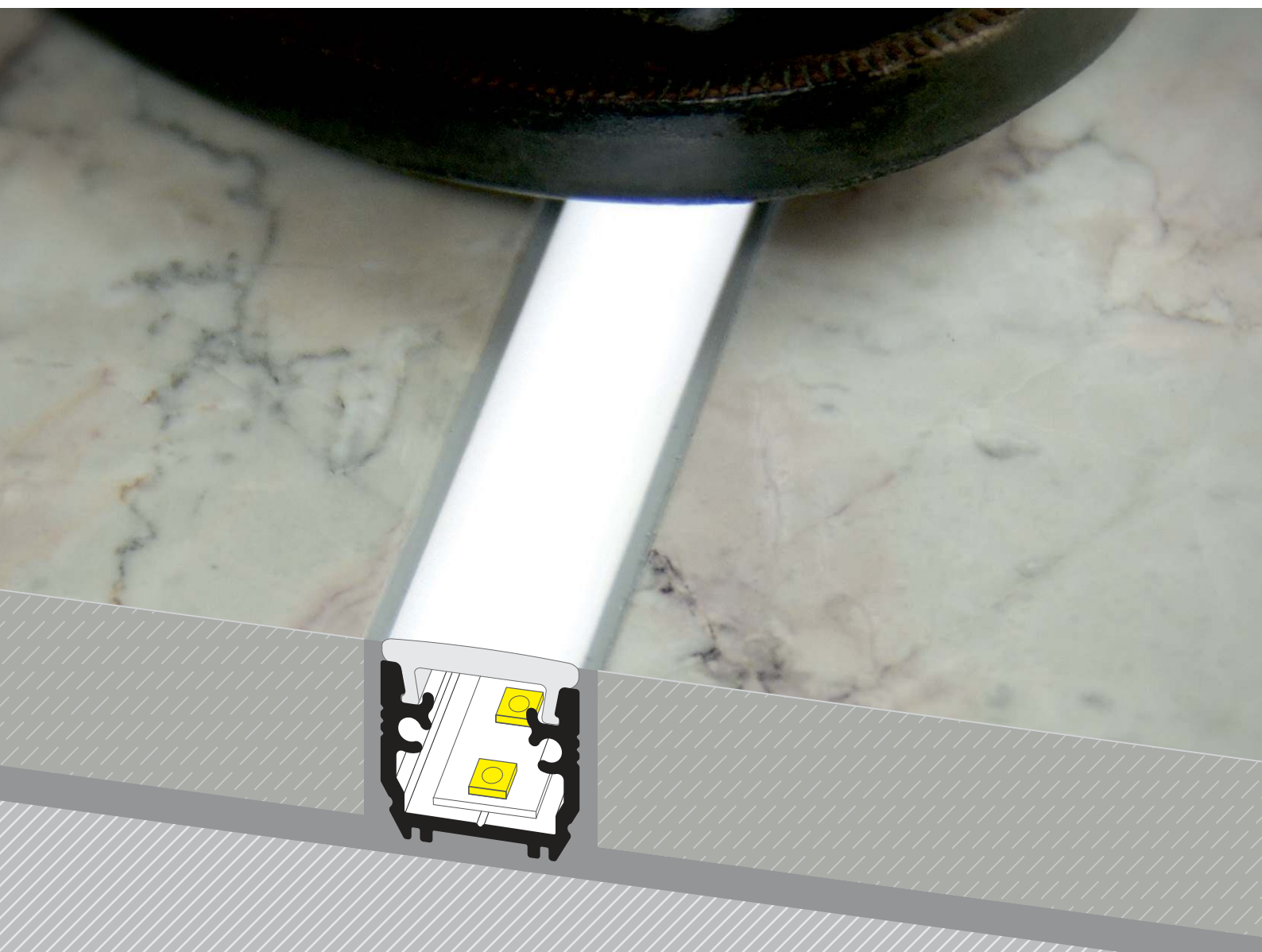

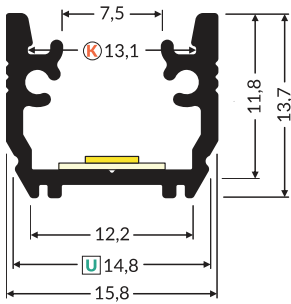

In high humidity conditions
use waterproof LED strip and silicone seal
Przy podwyższonej wilgotności
zaleca się użycie zestawu uszczelniającego
i wodoodpornej taśmy
Bei hoher Feuchtigkeit wasserdichtes Band
und Silikondichtung verwenden
Dans des conditions d'humidité élevée
il faut utiliser un ruban LED étanche et un joint
en silicone

K → 200

diffuser K click
klosz K klik
Abdeckung K einclipsbar
diffuseur K clic

U¹ → 204

mounting plate U
uchwyt U
Halter U
fixation U

U² → 204

mounting plate U cone
uchwyt U cone
Halter U cone
fixation U cône

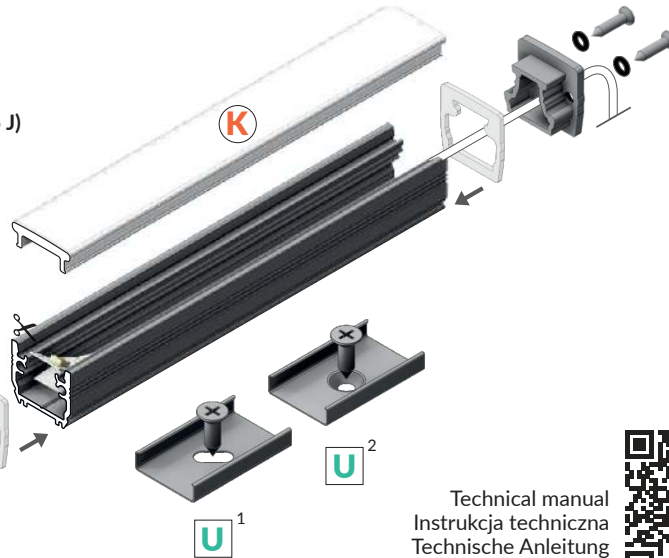
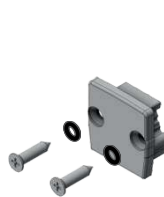
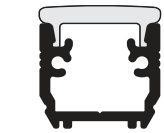

Technical manual
Instrukcja techniczna
Technische Anleitung
Manuel technique

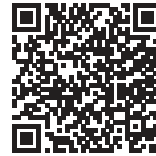

anodized
anodowany
eloxiert
surface anodisée

1000 mm	B1010020
2000 mm	B1020020
3000 mm	B1080020
4050 mm	B1090020



end cap FLOOR12
zaślepka FLOOR12
Endkappe FLOOR12
embout FLOOR12



silver
srebrny
silbern
argent
B1940040

grey
szary
grau
gris
B1940022

end cap FLOOR12 with hole
zaślepka FLOOR12 z otworem
Endkappe FLOOR12 mit Öffnung
embout FLOOR12 avec un trou



silver
srebrny
silbern
argent
B1960040

grey
szary
grau
gris
B1960022

sealings for FLOOR12 end caps
2x silicone sealings,
4x rubber o-ring
uszczelki do zaślepki FLOOR12
2x silikonowa uszczelka
4x gumowa uszczelka o-ring
Dichtungen für Endkappe FLOOR12
2x Silikon-Dichtungen
4x Gummi O-Ring
joints pour le embout FLOOR12
2x joint en silicone
4x joint torique en caoutchouc



B1830000



max 10 mm



tile-in
do płytek
für Fliesen
pour les carreaux



architectural
architektoniczne
architektonische
pour le bâtiment

- for the illumination of steps and their edges
- mounting in tiles
- elegant and compact (one-piece)
- without any glare effect
- versatile – for places with different levels of movement
- socket with Slick function

- do oświetlania stopni i wykończenia ich krawędzi
- montaż w płytkach
- elegancki i kompaktowy (jednoelementowy)
- bez efektu olśnienia
- uniwersalny – do miejsc o różnym natężeniu ruchu
- gniazdo z funkcją Slick

- zur Beleuchtung von Stufen und Treppenkanten
- Montage in den Fliesen
- elegant und kompakt (Einzelement)
- ohne Blendeffekt
- universell – für Stellen mit verschiedener Verkehrsdichte
- Steckplatz mit Slick-Funktion

- pour éclairer les marches et finir leurs bords
- installation dans le carrelage
- élégant et compact en 1 pièce
- sans effet d'éblouissement
- universel – pour les endroits avec intensité de circulation diverse
- prise avec fonction Slick



more
information



więcej
szczegółów



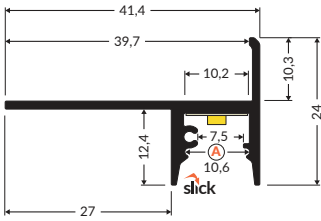

A → 194

diffuser A slide
klosz A wsuwany
Abdeckung A einschiebbar
diffuseur A coulissant

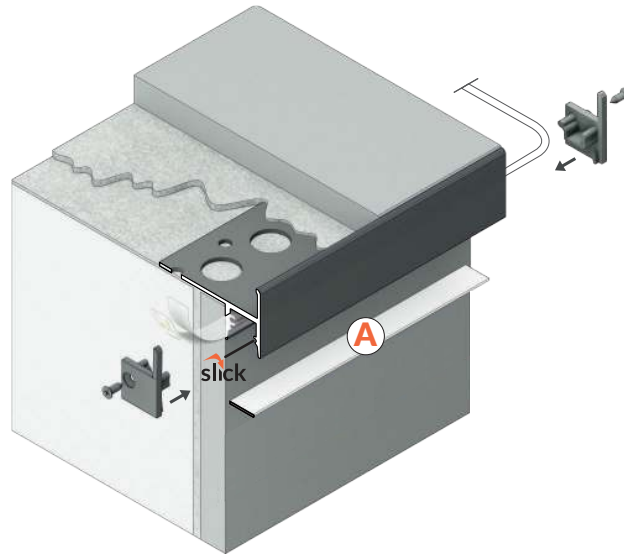

anodized
anodowany
eloxiert
surface anodisée

1000 mm	J8000120
2000 mm	J8000220
3000 mm	J8000320
4050 mm	J8000420

end cap UP-TILE10
zaślepka UP-TILE10
Endkappe UP-TILE10
embout UP-TILE10



silver
srebrny
silbern
argent
J8999940

grey
szary
grau
gris
J8999922

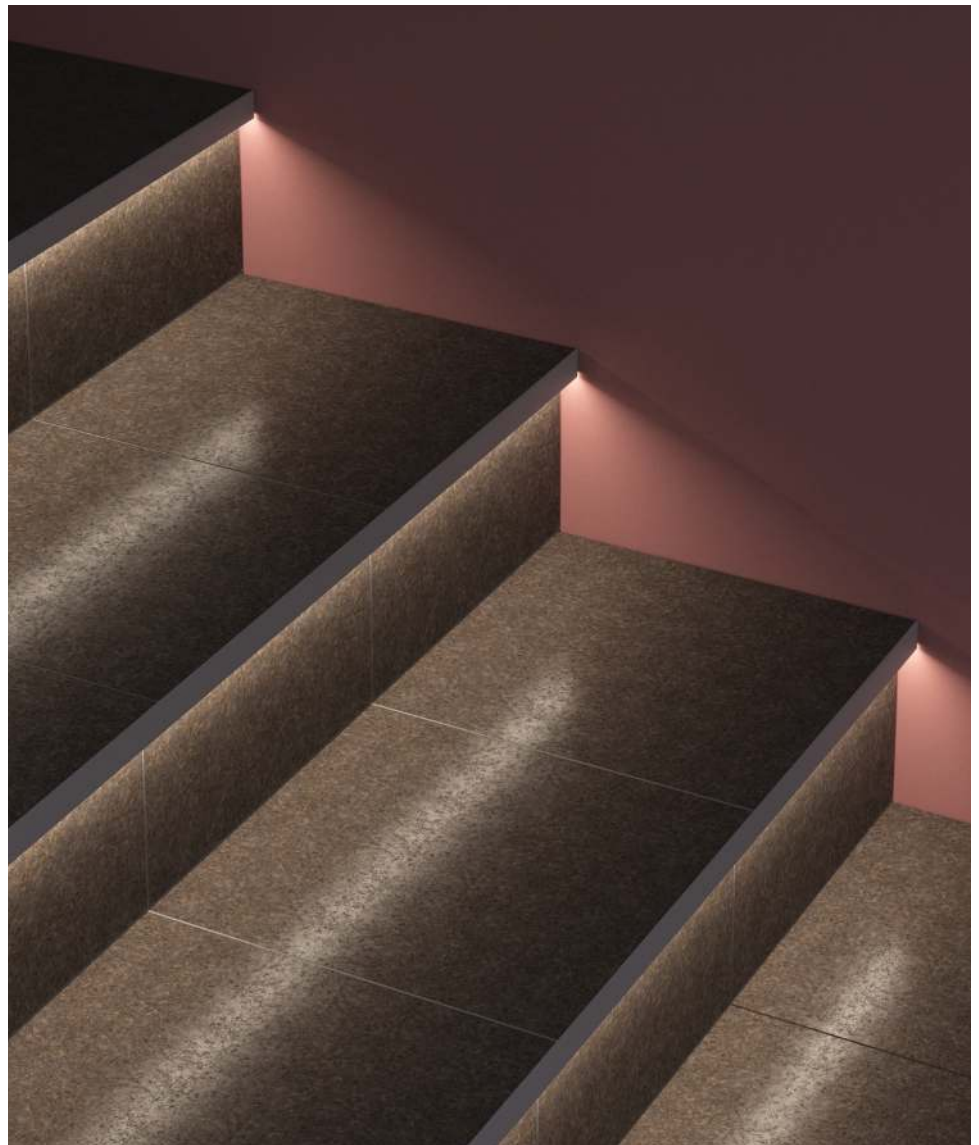

UNI-TILE12 C



max 12 mm



tile-in
do płytek
für Fliesen
pour les carreaux



architectural
architektoniczne
architektonische
pour le bâtiment

- family of profiles for under-tile mounting
- three mounting angles available: 90, 180, 270 degrees
- for 10 mm tiles
- perforated mounting holes

- rodzina profili do montażu podpłytkowego
- dostępne trzy kąty montażu: 90 / 180 / 270 st
- do płytek o grubości do 10 mm
- gotowe otworowanie montażowe

- eine Familie der Profile zur Unterfliesenmontage
- drei Montagewinkel zugänglich: 90 / 180 / 270 Grad
- für Fliesen bis 10 mm Dicke
- fertiges Montageloch

- une famille de profilés de montage dans le carrelage
- trois angles de montage disponibles : 90 / 180 / 270 degrés
- pour carreaux jusqu'à 10 mm d'épaisseur
- version disponible avec trous de montage prêts à l'emploi



UNI-TILE12 90 deg / st / grad / degrés C plus

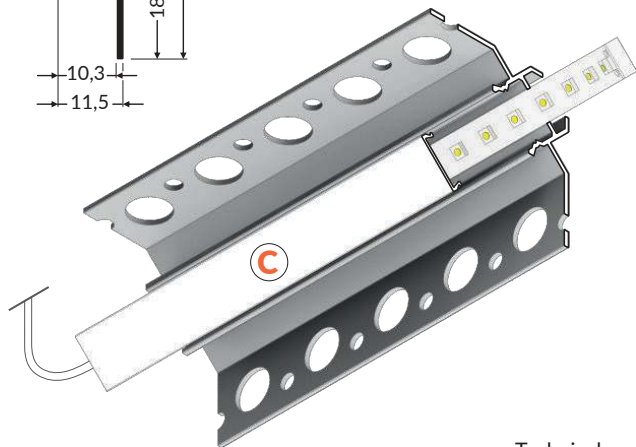
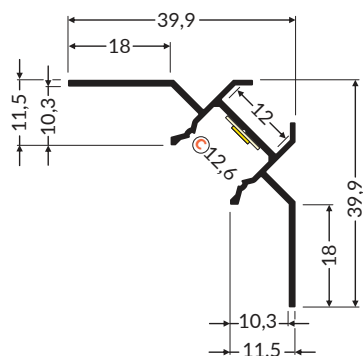

Technical manual
Instrukcja techniczna
Technische Anleitung
Manuel technique



more information



więcej szczegółów



C → 195

diffuser C click
klosz C klik
Abdeckung C einclipsbar
diffuseur C clic



anodized
anodowany
eloxiert
surface anodisée

1000 mm	G4000520
2000 mm	G4000620
3000 mm	G4000820
4050 mm	G4000920

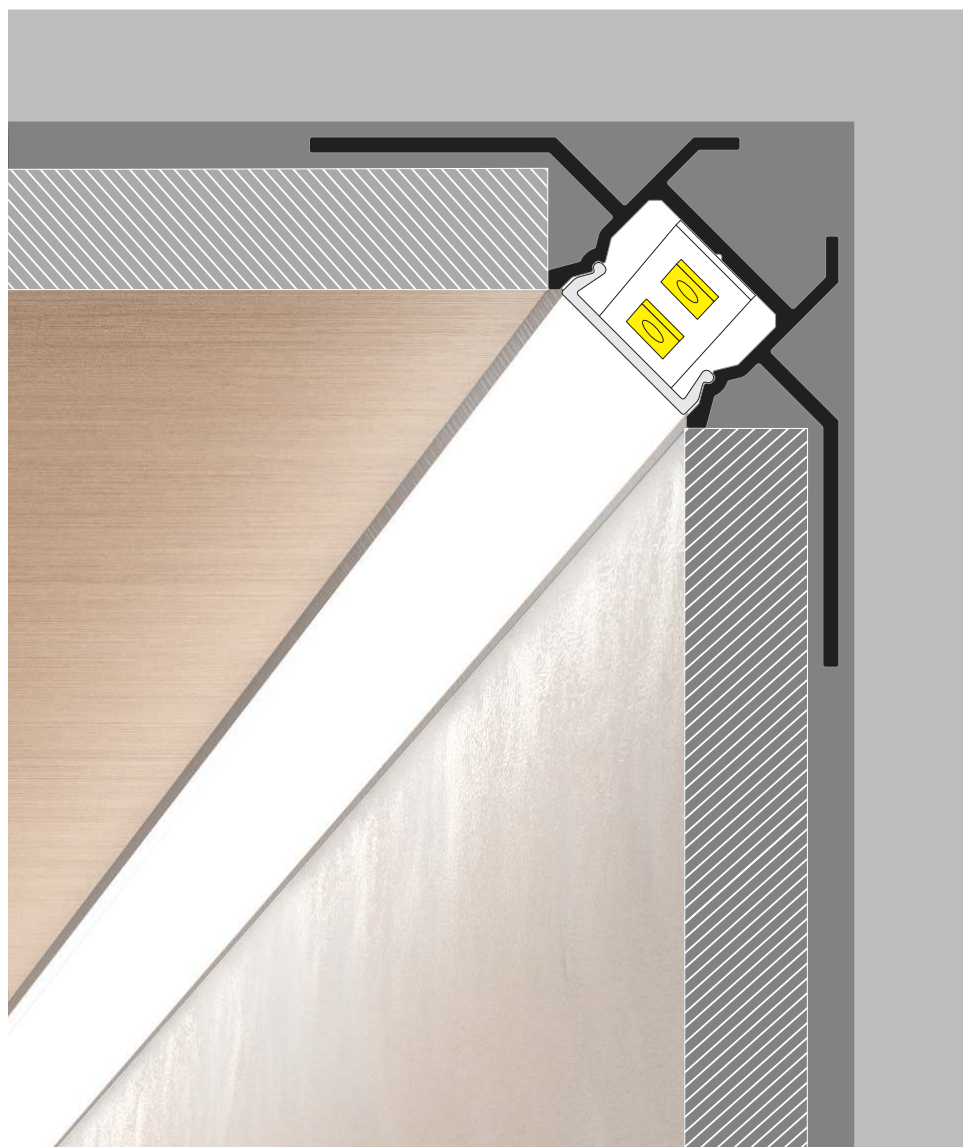

UNI-TILE12 180 deg / st / grad / degrés C plus

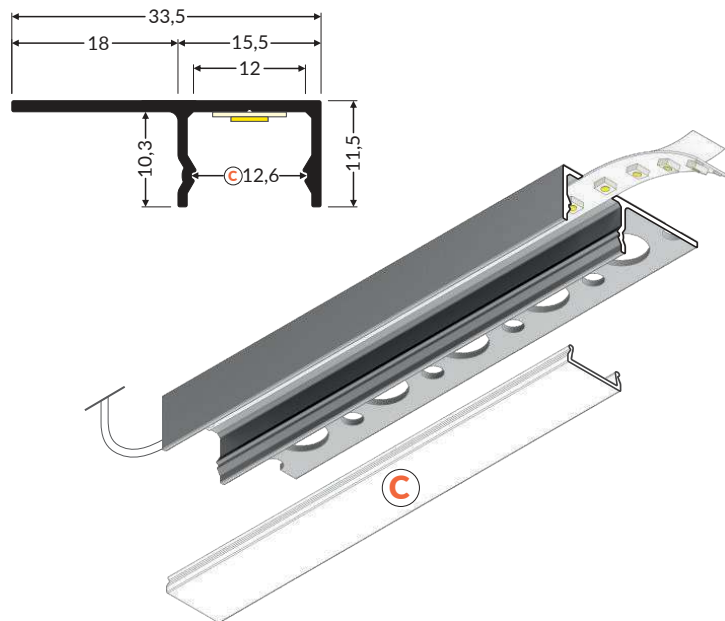

C → 195

diffuser C click
klosz C klik
Abdeckung C einclipsbar
diffuseur C clic



more
information



więcej
szczegółów



Technical manual
Instrukcja techniczna
Technische Anleitung
Manuel technique



anodized
anodowany
eloxiert
surface anodisée

1000 mm	G2000520
2000 mm	G2000620
3000 mm	G2000820
4050 mm	G2000920

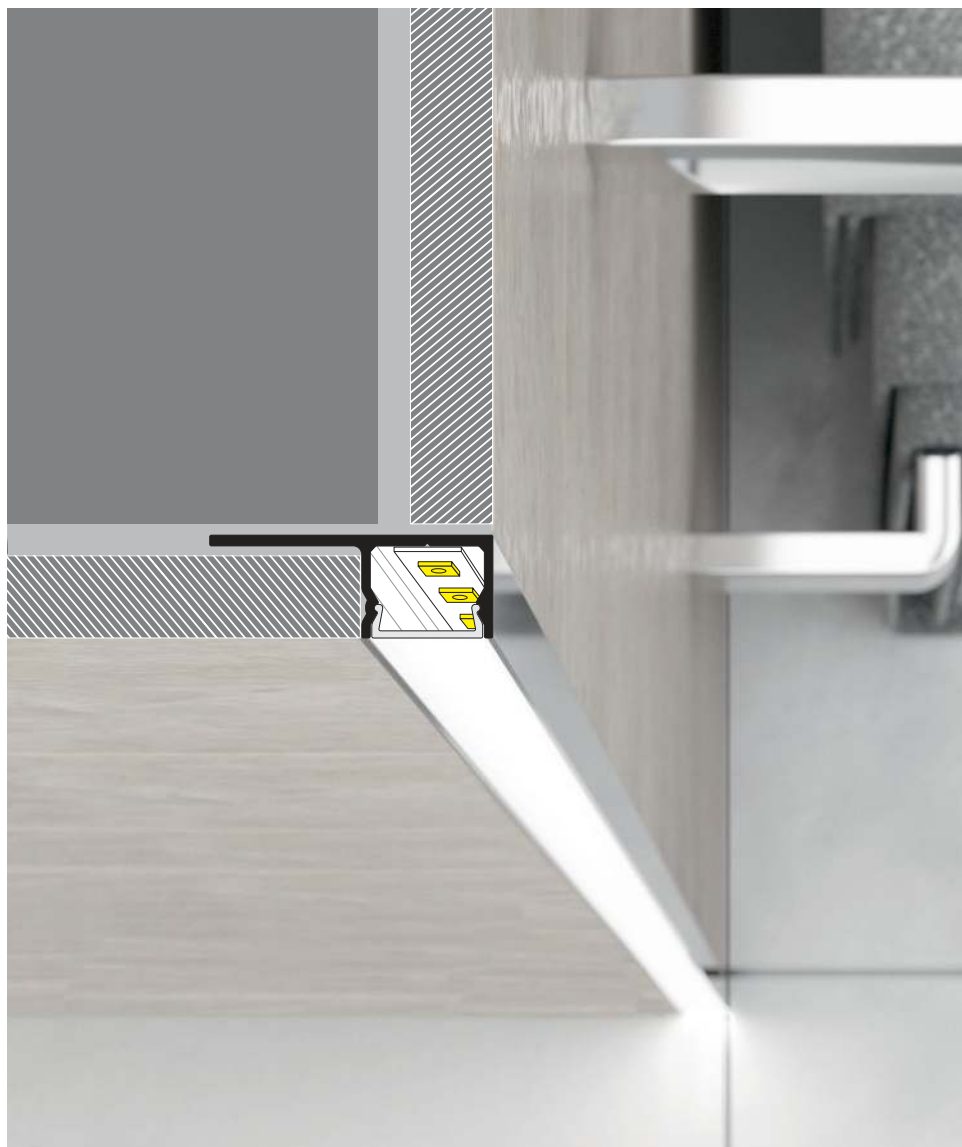

UNI-TILE12 270 deg / st / grad / degrés C plus

C → 195

diffuser C click
klosz C klik
Abdeckung C einclipsbar
diffuseur C clic

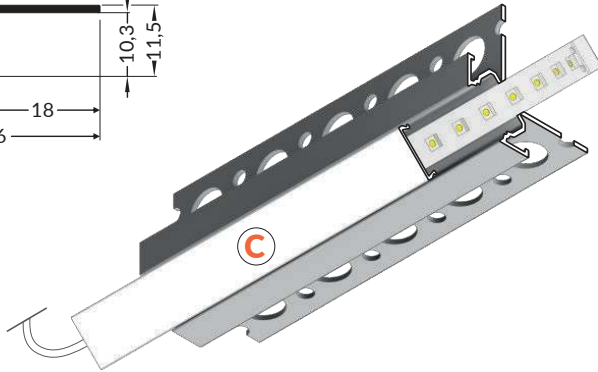
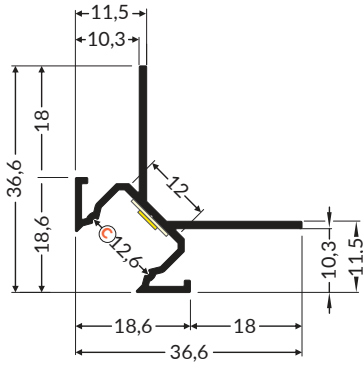

more information



więcej szczegółów



Technical manual
Instrukcja techniczna
Technische Anleitung
Manuel technique



anodized
anodowany
eloxiert
surface anodisée

1000 mm	G3000520
2000 mm	G3000620
3000 mm	G3000820
4050 mm	G3000920

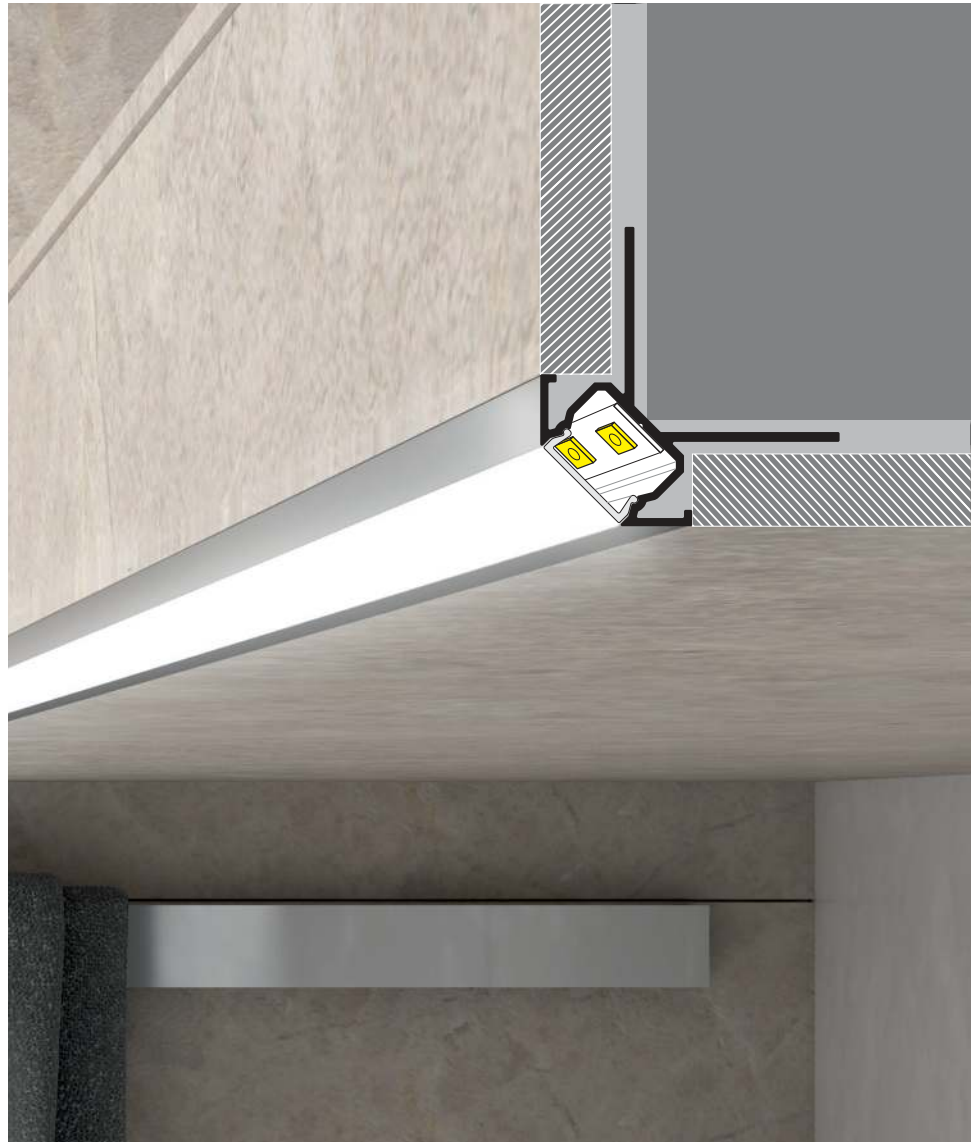

VED VANDET

AT THE WATER'S EDGE

AM WASSER

OM SOMMEREN LEVER VI PÅ STRANDEN.
HER ER LIVET DET SAMME
SOM ALTID.

HER FISKER VI OG JAGER KYSTENS FUGLE.
MEN HAVET ER EN LUNEFULD NABO.
VI MÅ OFRE TIL GUDERNE,
SÅ DE FORMILDES
OG FYLDER VORES RUSER MED FISK.

WE LIVE ALONG THE COAST IN THE SUMMER.
THIS IS WHERE WE LIVE LIFE
AS ALWAYS.
THIS IS WHERE WE FISH AND HUNT COASTAL BIRDS.
BUT THE SEA IS A FICKLE NEIGHBOUR.
WE MUST MAKE SACRIFICES TO THE GODS
TO PACIFY THEM
SO THEY FILL OUR TRAPS WITH FISH.

IM SOMMER LEBEN WIR AM STRAND.
HIER IST DAS LEBEN
DASSELBE WIE IMMER.
HIER FISCHEN WIR UND JAGEN DIE KÜSTENVÖGEL.
DOCH DAS MEER IST EIN LAUNISCHER NACHBAR.
WIR MÜSSEN DEN GÖTTERN OPFER BRINGEN,
DAMIT SIE UNS MILDE GESTIMMT SIND
UND UNSERE REUSEN MIT FISCHEN FÜLLEN.

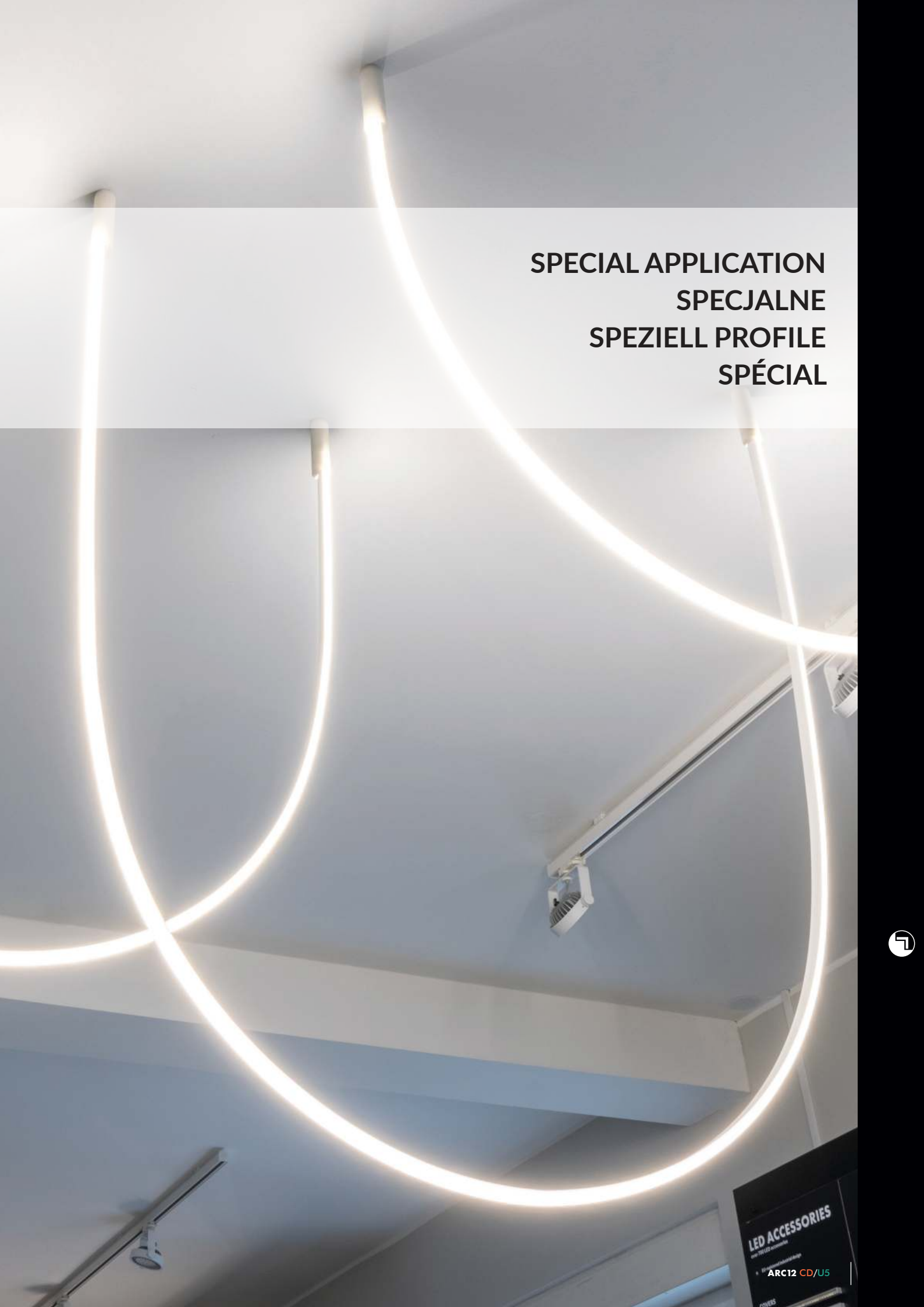

**SPECIAL APPLICATION
SPECJALNE
SPEZIELL PROFILE
SPÉCIAL**



LED ACCESSORIES
with 10000h lifetime
#1 in the industry
ARC12 CD/U5

ARC12 CD/U5



max 12 mm



special application
specjalny
speziell
spécial



furniture
meblowe
Möbel-
mobilier

- flexible aluminium profile
- possibility of bending in two directions
- the profile keeps the shape of the bend
- minimum bending radius: 50 cm
- decorative and illuminating purpose of the profile
- possibility of using two diffusers - better light scattering
- possible outside installation (with D diffuser and waterproof LED strip used)

- aluminiowy profil do zastosowań giętych w dwóch kierunkach jednej płaszczyzny
- profil zachowujący kształt wygięcia
- minimalny promień gięcia: 50 cm
- profil dekoracyjno-oświetleniowy
- możliwość założenia dwóch kloszy - lepsze rozproszenie światła
- możliwość montażu zewnętrznego (przy zastosowaniu klosza D oraz taśmy wodoodpornej)

- ein Aluminiumprofil für Biegen in zwei Richtungen einer Ebene
- das Profil behält die Biegeform
- minimaler Biegungsradius: 50 cm
- Dekor- und Beleuchtungsprofil
- die Möglichkeit zwei Abdeckung anzuwenden - bessere Diffusion
- Montage im Außenbereich möglich (bei dem Anwenden einer D einclipsbaren Abdeckung und eines wasserdichten LED Streifens)

- profilé en aluminium pour applications pliables dans deux directions sur un même plan
- profilé qui maintient la forme du pli
- rayon de pli minimum : 50 cm
- profilé décoratif et lumineux
- possibilité d'installer deux diffuseurs - meilleure dispersion de la lumière
- possibilité d'installation externe (avec l'utilisation du diffuseur D et de ruban étanche)



more
information

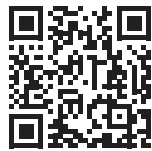

więcej
szczegółów



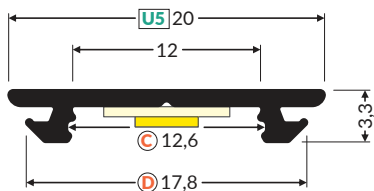

sling
zawiesie
Abhängung
suspension
→ 209

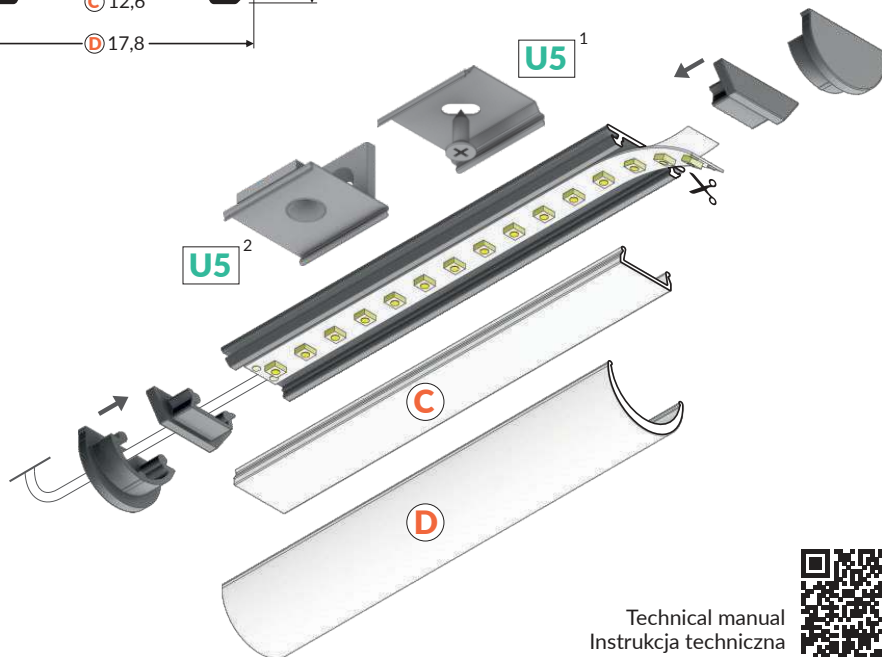

Technical manual
Instrukcja techniczna
Technische Anleitung
Manuel technique



U5¹ → 205

mounting plate U5 cone
uchwyt U5 cone
Halter U5 cone
fixation U5 cône

U5² → 205

mounting plate U5 side
uchwyt U5 boczny
Halter U5 seitlich
fixation U5 latérale

C → 195

diffuser C click
klosz C klik
Abdeckung C einclipsbar
diffuseur C clic

D → 198

diffuser D click
klosz D klik
Abdeckung D einclipsbar
diffuseur D clic



white painted
biały malowany
weiß lackiert
peint en blanc



anodized
anodowany
eloxiert
surface anodisée



black painted
czarny malowany
schwarz lackiert
peint en noir



raw aluminium
surowe aluminium
Rohaluminium
aluminium brut

1000 mm	B2000001	B2000020	B2000002	B2000000
2000 mm	B2010001	B2010020	B2010002	B2010000
3000 mm	B2060001	B2060020	B2060002	B2060000
4050 mm	B2070001	B2070020	B2070002	B2070000

end cap ARC12
zaślepka ARC12
Endkappe ARC12
embout ARC12



white
biały
weiß
blanc
B2960001

silver
srebrny
silbern
argent
B2960040

black
czarny
schwarz
noir
B2960002

grey
szary
grau
gris
B2960022

end cap ARC12 D
zaślepka ARC12 D
Endkappe ARC12 D
embout ARC12 D



white
biały
weiß
blanc
B2980001

silver
srebrny
silbern
argent
B2980040

black
czarny
schwarz
noir
B2980002

grey
szary
grau
gris
B2980022



PEN8 |



max 8 mm



special application
specjalny
speziell
spécial



furniture
meblowe
Möbel-
mobilier

- decorative and lighting
profile, eg. for glass cabinets
- possibility of mounting
between the walls of a cabinet

- profil dekoracyjno-
oświetleniowy, np. do
szklanych gablot
- możliwość mocowania
pomiędzy ściankami

- ein dekorativ-beleuchtendes
Profil, z.B. für die Glasvitrinen
- die Möglichkeit der Montage
zwischen den Wänden

- profilé décoratif et lumineux,
par ex. pour vitrines en verre
- possibilité de montage entre
deux murs



more
information



więcej
szczegółów



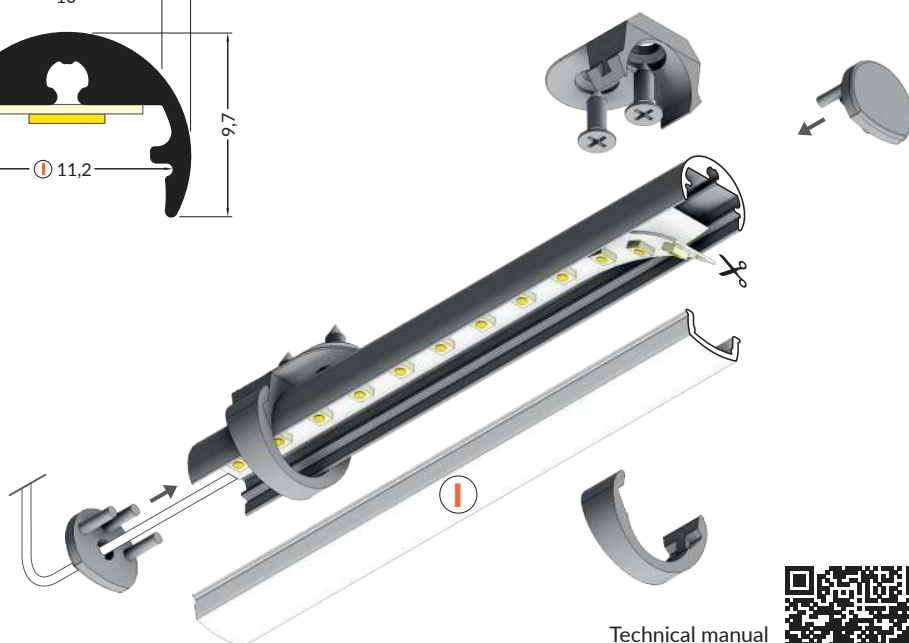
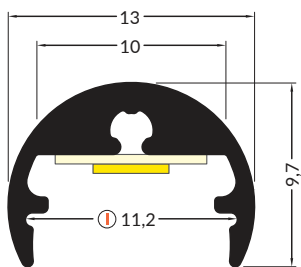

Technical manual
Instrukcja techniczna
Technische Anleitung
Manuel technique



→ 200

diffuser I click
klosz I klik
Abdeckung I einclipsbar
diffuseur I clic



anodized
anodowany
eloxiert
surface anodisée

1000 mm	86020020
2000 mm	86030020
3000 mm	86530020
4050 mm	86540020

end cap PEN8
zaślepka PEN8
Endkappe PEN8
embout PEN8



silver
srebrny
silbern
argent
86490040
grey
szary
grau
gris
86490022

end cap PEN8 with hole
zaślepka PEN8 z otworem
Endkappe PEN8 mit Öffnung
embout PEN8 avec un trou



silver
srebrny
silbern
argent
86470040
grey
szary
grau
gris
86070022

holder PEN8 flat
uchwyt PEN8 płaski
Halter PEN8 flach
fixation PEN8 plat



material: ABS
materiał: ABS
Material: ABS
matériel: ABS

grey
szary
grau
gris
86070022

holder PEN8 simple
uchwyt PEN8 prosty
Halter PEN8 einfach
fixation PEN8 simple



material: zinc coated steel
materiał: stal ocynkowana
Material: verzinkter Stahl
matériel: acier galvanisé

zinc coated steel
stal ocynkowana
verzinkter Stahl
acier galvanisé
86370030

holder PEN8 ring
uchwyt PEN8 ring
Halter PEN8 Ring
fixation PEN8 ring



material: brass
materiał: mosiądz
Material: Messing
matériel: laiton

chrome
chrom
Chrom
chrome
86440003

material: aluminium
materiał: aluminium
Material: Aluminium
matériel: aluminium

raw aluminium
surowe aluminium
Rohaluminium
aluminium brut
86440000

PEN12 CJ



max 12mm



special application
specjalny
speziell
spécial



furniture
meblowe
Möbel-
mobilier

- wall and furniture application
- rotation allows you to direct
the light

- ścienny i meblowy
- obrotowość umożliwia
ukierunkowanie światła

- für Wände und Möbel
- Drehung ermöglicht es, das
Licht zu lenken

- pour les murs et le mobilier
- pivotant pour diriger la lumière



more
information



więcej
szczegółów



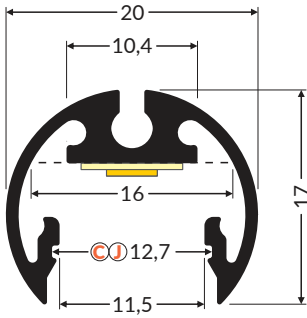

Technical manual
Instrukcja techniczna
Technische Anleitung
Manuel technique



J → 200

diffuser J slide
klosz J wsuwany
Abdeckung J einschiebbar
diffuseur J coulissant

C → 195

diffuser C click
klosz C klik
Abdeckung C einclipsbar
diffuseur C clic

C¹ → 195

diffuser C click lens gen2
klosz C klik soczewka gen2
Abdeckung C einclipsbar Linse gen2
diffuseur C clic lentille gen 2



white painted
biały malowany
weiß lackiert
peint en blanc



anodized
anodowany
eloxiert
surface anodisée



black painted
czarny malowany
schwarz lackiert
peint en noir

1000 mm	F7000101	F7000120	F7000102
2000 mm	F7000201	F7000220	F7000202
3000 mm	F7000301	F7000320	F7000302
4050 mm	F7000401	F7000420	F7000402

end cap PEN12
zaślepka PEN12
Endkappe PEN12
embout PEN12



white
biały
weiß
blanc
F7009901

silver
srebrny
silbern
argent
F7009940

black
czarny
schwarz
noir
F7009902

grey
szary
grau
gris
F7009922

holder PEN12 flat
uchwyt PEN12 płaski
Halter PEN12 flach
fixation PEN12 plat

material: stainless steel
materiał: stal nierdzewna
Material: rostfreier Stahl
matériel: acier inoxydable

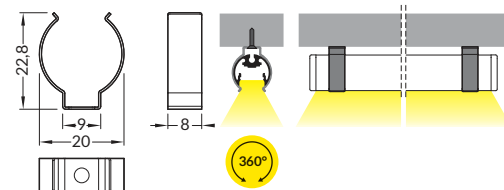

inox
F7009019

holder PEN12 ring
uchwyt PEN12 ring
Halter PEN12 Ring
fixation PEN12 ring

material: brass
materiał: mosiądz
Material: Messing
matériel: laiton

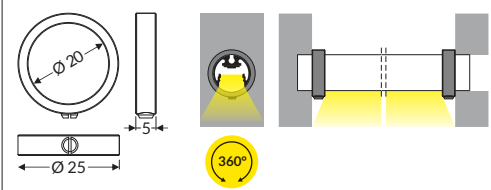

chrome
chrom
Chrom
chrome
F7009203

BACK10 A/UX



max 10 mm



special application
specjalny
speziell
spécial



furniture
meblowe
Möbel-
mobilier

- decorative illumination
- the T-shaped structure makes possible to direct the light beam in two directions (up/down, left/right)
- mounting with two dedicated holders (to the wall) or directly to the piece of furniture, using screws
- optionally, the A diffuser can be used

- oświetlenie dekoracyjne
- konstrukcja w kształcie litery "T" pozwala na skierowanie strumienia świetlnego w dwóch kierunkach (góra/dół, lewo/prawo)
- mocowanie za pomocą dedykowanych uchwytów (do ściany) lub bezpośrednio przy pomocy wkrętów (do mebla)
- opcjonalne użycie klosza A

- dekorative Beleuchtung
- Konstruktion in der Form des Buchstabens "T" ermöglicht den Lichtstrom in zwei Richtungen zu richten (oben/unten, links/rechts)
- Befestigung mit Hilfe von gewidmeten Haltern (an der Wand) oder direkt mit Hilfe der Schrauben (am Möbel)
- eine optionale Anwendung der Abdeckung A

- éclairage décoratif
- la conception en forme de «T» permet au faisceau lumineux d'être dirigé dans deux directions (haut/bas, gauche/droite)
- montage avec des fixations dédiées (au mur) ou directement avec des vis (au meuble)
- utilisation optionnelle du diffuseur A



more
information



więcej
szczegółów



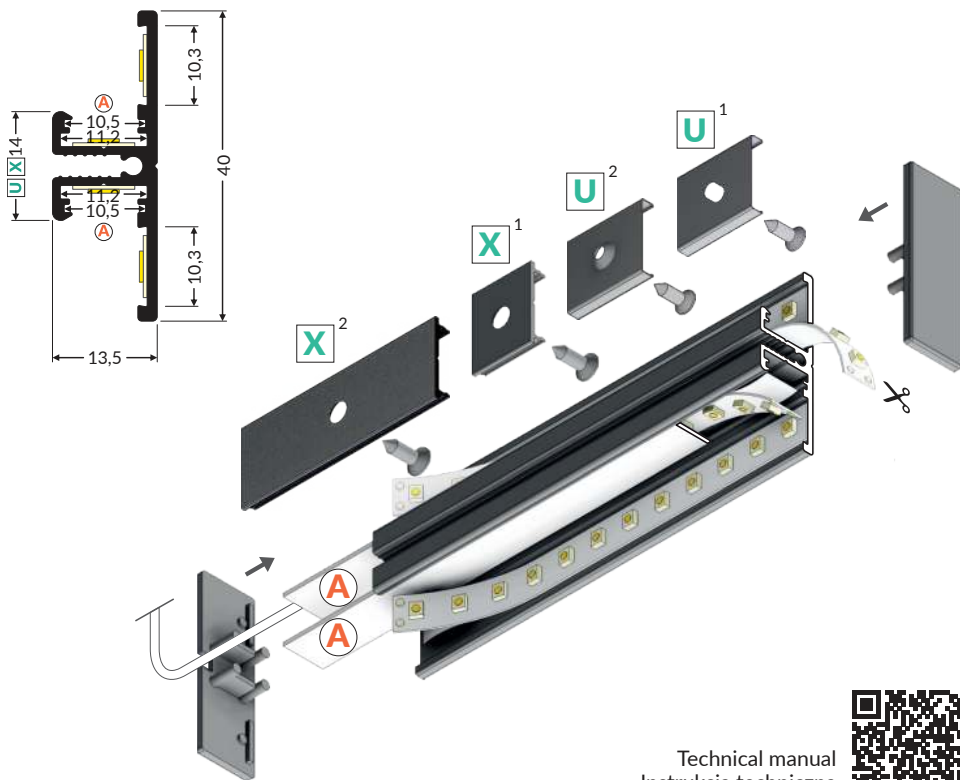

Technical manual
Instrukcja techniczna
Technische Anleitung
Manuel technique



U¹ → 204

mounting plate U
uchwyt U
Halter U
fixation U

U² → 204

mounting plate U cone
uchwyt U cone
Halter U cone
fixation U cône

X¹ → 207

mounting plate X
uchwyt X
Halter X
fixation X

X² → 207

connector X 180 deg
łącznik X 180 st
Verbinder X 180 Grad
connecteur X 180 degrés

A → 194

diffuser A slide
klosz A wsuwany
Abdeckung A einschiebbar
diffuseur A coulissant



white painted
biały malowany
weiß lackiert
peint en blanc



anodized
anodowany
eloxiert
surface anodisée



black painted
czarny malowany
schwarz lackiert
peint en noir



raw aluminium
surowe aluminium
Rohaluminium
aluminium brut

1000 mm	90020001	90020020	90020002	90020000
2000 mm	90030001	90030020	90030002	90030000
3000 mm	90170001	90170020	90170002	90170000
4050 mm	90180001	90180020	90180002	90180000

end cap BACK10
zaślepka BACK10
Endkappe BACK10
embout BACK10



white biały weiß blanc	silver srebrny silbern argent
90100001	90100040

black czarny schwarz noir	grey szary grau gris
90100002	90100022

end cap BACK10 with hole
zaślepka BACK10 z otworem
Endkappe BACK10 mit Öffnung
embout BACK10 avec un trou



white biały weiß blanc	silver srebrny silbern argent
90150001	90150040

black czarny schwarz noir	grey szary grau gris
90150002	90150022



WAY10 C

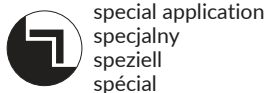

- strip for illuminating passageways
- dedicated for wall mounting
- hidden mounting and wiring
- curved shape

- listwa do podświetlania ciągów komunikacyjnych
- dedykowany do montażu ściennego
- ukryte mocowanie i przewody
- obta forma

- Sockelleiste zur Beleuchtung von Durchgängen
- speziell für die Wandmontage
- verdeckte Befestigung und Verkabelung
- abgerundete Form

- plinthe pour éclairer les passages de circulation
- dédié au montage mural
- fixation et câblage cachés
- forme arrondie



more
information



więcej
szczegółów



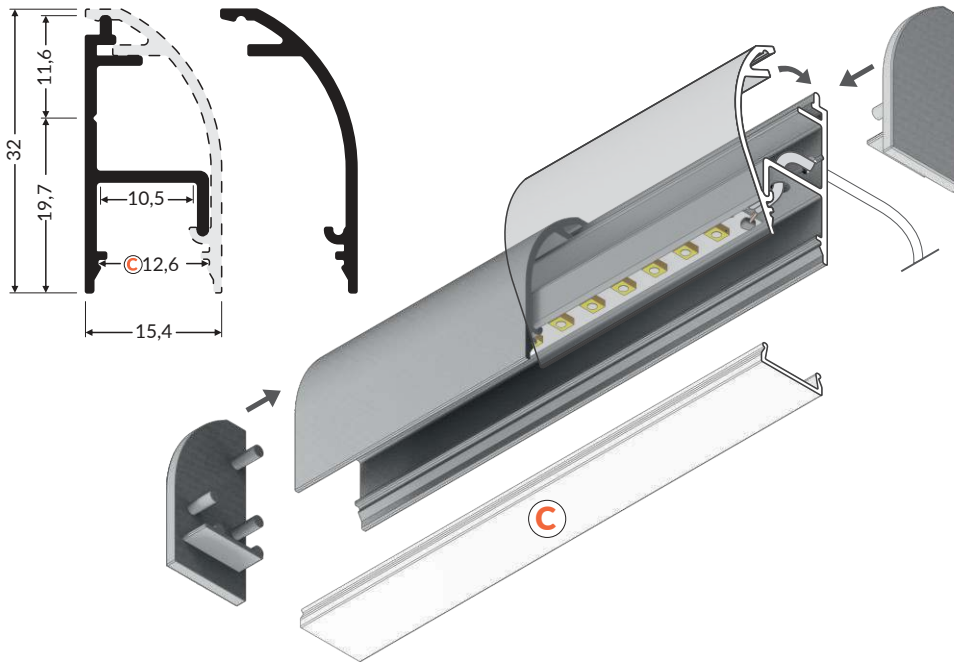

C → 195

diffuser C click
klosz C klik
Abdeckung C einclipsbar
diffuseur C clic

Technical manual
Instrukcja techniczna
Technische Anleitung
Manuel technique



LED profile WAY10
profil LED WAY10
LED Profil WAY10
profilé LED WAY10

cover WAY10
osłona WAY10
Abdeckplatte WAY10
cache WAY10



anodized
anodowany
eloxiert
surface anodisée

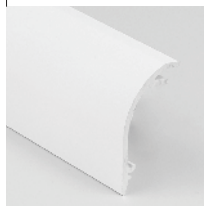

white painted
biały malowany
weiß lackiert
peint en blanc



anodized
anodowany
eloxiert
surface anodisée



black painted
czarny malowany
schwarz lackiert
peint en noir



raw aluminium
surowe aluminium
Rohaluminium
aluminium brut

1000 mm	F9000120	F9000501	F9000520	F9000502	F9000500
2000 mm	F9000220	F9000601	F9000620	F9000602	F9000600
3000 mm	F9000320	F9000701	F9000720	F9000702	F9000700
4050 mm	F9000420	F9000801	F9000820	F9000802	F9000800

end cap WAY10
zaślepka WAY10
Endkappe WAY10
embout WAY10



white
biały
weiß
blanc
F9009901

silver
srebrny
silbern
argent
F9009940

black
czarny
schwarz
noir
90100002

grey
szary
grau
gris
F9009922



WALLE12 BCD



max 12 mm



special application
specjalny
speziell
spécial



architectural
architektoniczne
architektonische
pour le batiment

- mounted directly to a wall or ceiling
- 7 types of matching diffusers
- possibility of outdoor using (with D diffuser and waterproof LED strip)

- montowany bezpośrednio do ściany lub sufitu
- 7 rodzajów pasujących kloszy
- możliwość zastosowania zewnętrznego (przy użyciu klosza D i taśmy wodoodpornej)

- direkt an der Wand oder Decke montiert
- 7 Abdeckungen zur Wahl
- Montage im Außenbereich möglich (bei dem Anwenden einer D einclipsbaren Abdeckung und eines wasserdichten LED Streifens)

- monté directement au mur ou au plafond
- 7 types de diffuseurs assortis
- possibilité d'utilisation externe (à l'aide du diffuseur D et de ruban étanche)



more
information



więcej
szczegółów

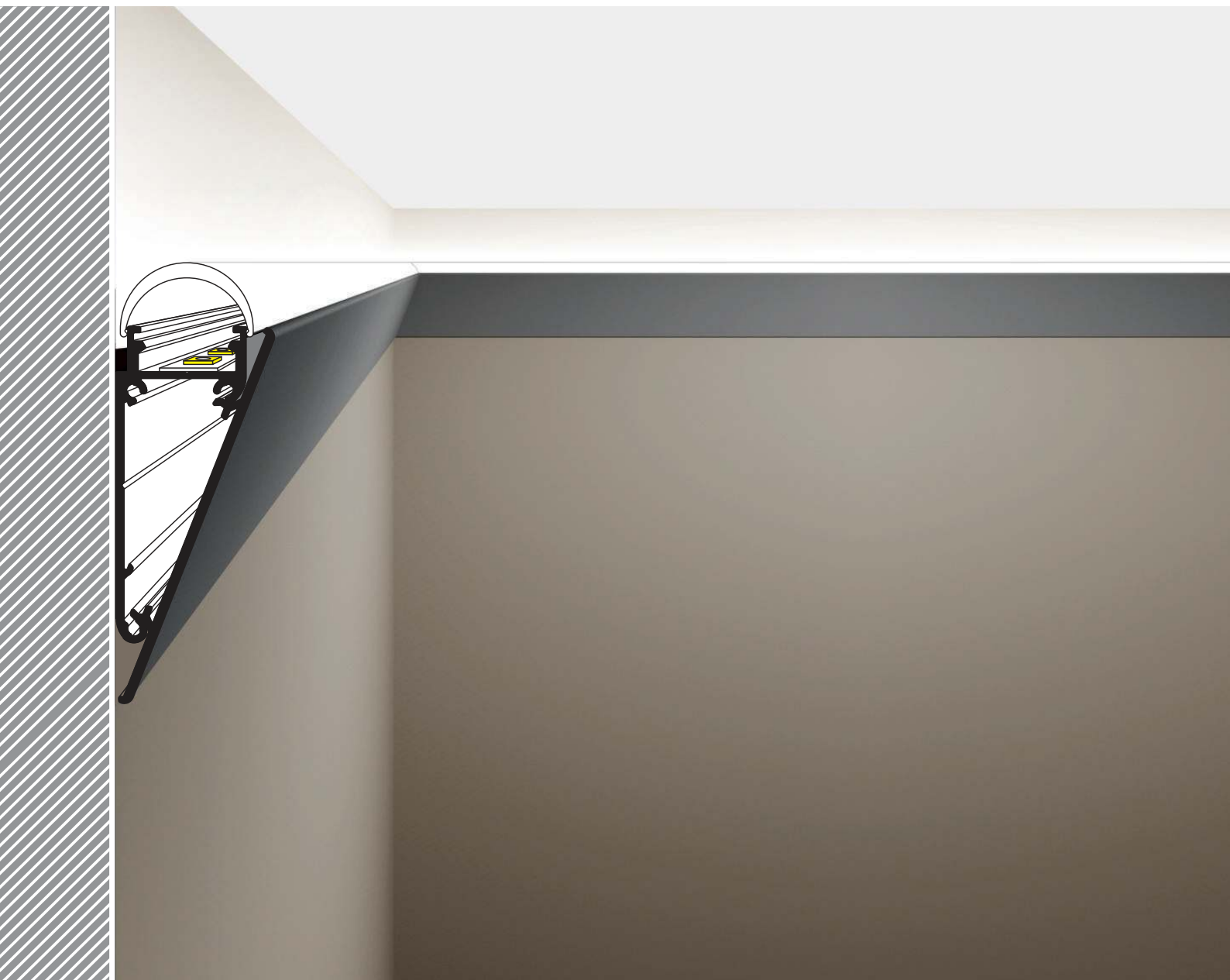

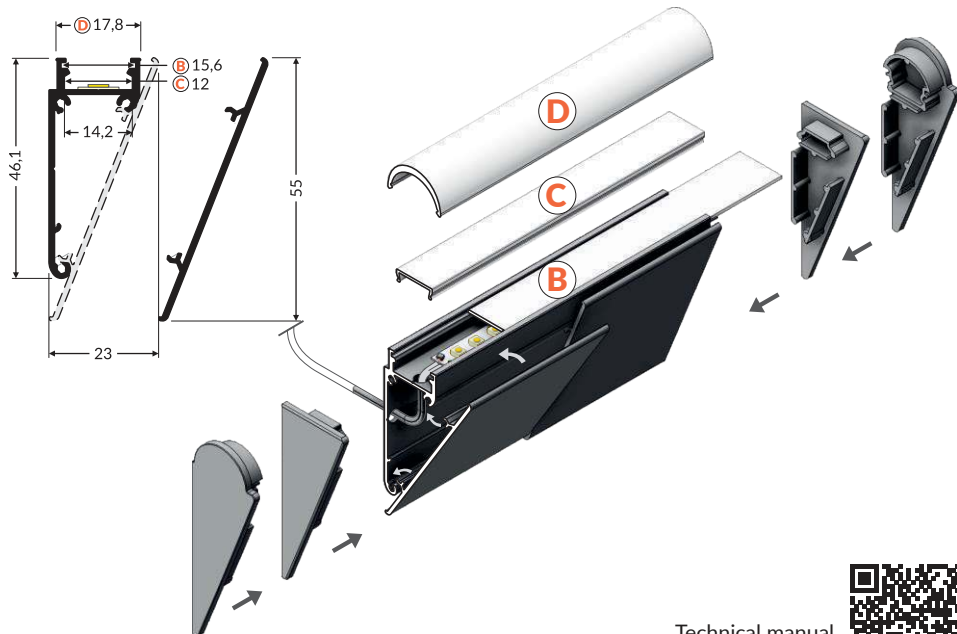

D → 198

diffuser D click
klosz D klik
Abdeckung D einclipsbar
diffuseur D clic

C → 195

diffuser C click
klosz C klik
Abdeckung C einclipsbar
diffuseur C clic

B → 194

diffuser B slide
klosz B wsuwany
Abdeckung B einschiebbar
diffuseur B coulissant

Technical manual
Instrukcja techniczna
Technische Anleitung
Manuel technique



LED profile WALLE12
profil LED WALLE12
LED Profil WALLE12
profilé LED WALLE12



white painted
biały malowany
weiß lackiert
peint en blanc

1000 mm **B8050001**
2000 mm **B8060001**
3000 mm **B8090001**
4050 mm **B8100001**



anodized
anodowany
eloxiert
surface anodisée

B8010020
B8020020
B8090020
B8100020



raw aluminium
surowe aluminium
Rohaluminium
aluminium brut

B8010000
B8020000
B8090000
B8100000

cover WALLE12
osłona WALLE12
Abdeckplatte WALLE12
cache WALLE12



white painted
biały malowany
weiß lackiert
peint en blanc

B8070001
B8080001
B8110001
B8120001



anodized
anodowany
eloxiert
surface anodisée

B8030020
B8040020
B8110020
B8120020

end cap WALLE12
zaślepka WALLE12
Endkappe WALLE12
embout WALLE12



white
biały
weiß
blanc

B8900001
B8900040

grey
szary
grau
gris
B8900022

silver
srebrny
silbern
argent

B8900040

end cap WALLE12 D
zaślepka WALLE12 D
Endkappe WALLE12 D
embout WALLE12 D



white
biały
weiß
blanc

B8890001
B8890040

grey
szary
grau
gris
B8890022

silver
srebrny
silbern
argent

B8890040

connector WALLE12 180 deg
łącznik WALLE12 180 st
Verbinder WALLE12 180 Grad
connecteur WALLE12 180 degrés

material: stainless steel
materiał: stal nierdzewna
Material: rostfreier Stahl
matériel: acier inoxydable

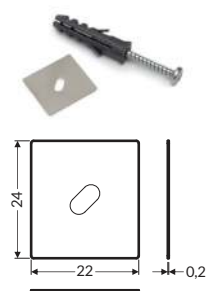

inox
B8950019

connector WALLE12 90 deg
łącznik WALLE12 90 st
Verbinder WALLE12 90 Grad
connecteur WALLE12 90 degrés

material: aluminium
materiał: aluminium
Material: Aluminium
matériel: aluminium



white painted
biały malowany
weiß lackiert
peint en blanc
B8910001

anodized
anodowany
eloxiert
surface anodisée
B8910020



max 10 mm



special application
specjalny
speziell
spécial



architectural
architektoniczne
architektonische
pour le batiment

- for the illumination of steps and their edges
- basic and compact (one-piece)
- without any glare effect
- anti-slip ribbing
- socket with Slick function outline

- do oświetlania stopni i wykończenia ich krawędzi
- podstawowy i kompaktowy (jednoelementowy)
- bez efektu olśnienia
- antypoślizgowe żebrowanie
- gniazdo z funkcją Slick

- zur Beleuchtung von Stufen und Treppenkanten
- einfach und kompakt (Einzelement)
- ohne Blendeffect
- rutschfeste Rippenfläche
- Sockel mit Slick-Funktion

- pour éclairer les marches et finir leurs bords
- basique et compact (en 1 seule pièce)
- sans effet d'éblouissement
- rainures antidérapantes
- prise avec fonction Slick



more
information



więcej
szczegółów



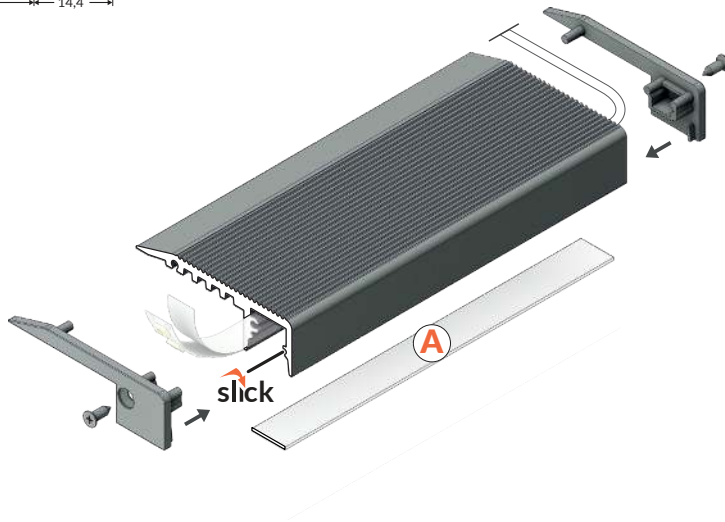
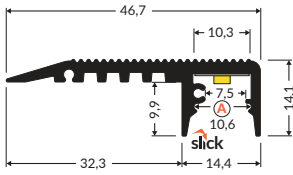

A → 194

diffuser A slide
klosz A wsuwany
Abdeckung A einschiebbar
diffuseur A coulissant



anodized
anodowany
eloxiert
surface anodisée

1000 mm	J9000120
2000 mm	J9000220
3000 mm	J9000320
4050 mm	J9000420

end cap UP-MINI10
zaślepka UP-MINI10
Endkappe UP-MINI10
embout UP-MINI10



silver
srebrny
silbern
argent
J9999940

grey
szary
grau
gris
J9999922

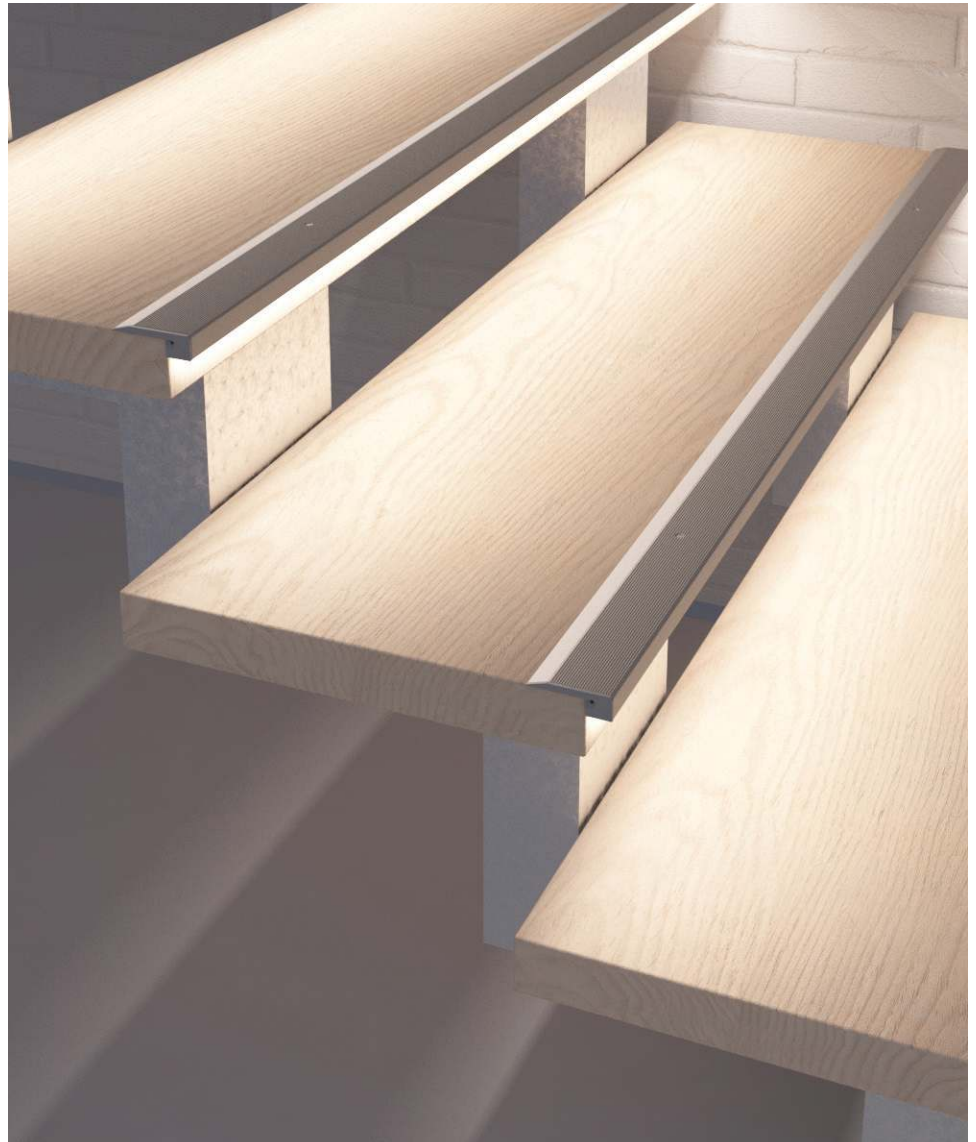

UP-BOLD12 K

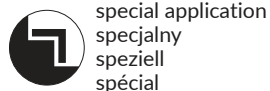

- for accentuating step edges
- simple, reinforced profile design (one-piece)
- reinforced K shade
- for use in areas with increased levels of movement (e.g. cinemas, theatres, etc.)
- good light diffusion (even with 60 P/m strip)
- anti-slip ribbing

- do akcentowania krawędzi stopni
- prosta, wzmocniona konstrukcja profilu (jednoelementowy)
- wzmocniony klosz K
- do stosowania przy zwiększonym natężeniu ruchu (np. kina, teatry itp.)
- dobre rozproszenie światła (nawet przy taśmie 60 P/m)

- zur Hervorhebung von Treppenkanten
- einfache, verstärkte Profilkonstruktion (Einzelement)
- verstärkte Abdeckung K
- zur Anwendung bei großer Verkehrsdichte (z.B. Kinos, Theater usw.)
- gute Lichtstreuung (auch beim Streifen 60 P/m)
- rutschfeste Rippenfläche

- pour accentuer les bords des marches
- construction de profilé simple et renforcée (en 1 seule pièce)
- cloche K renforcée
- pour utiliser avec circulation intense (p.ex. cinémas, théâtres etc.)
- bonne dispersion de la lumière (même avec une bande 60 P/m)



more
information



więcej
szczegółów



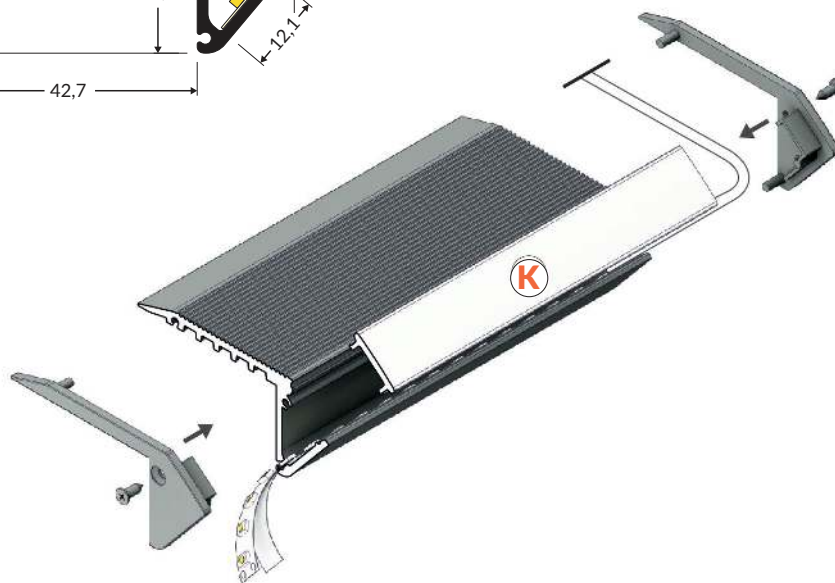
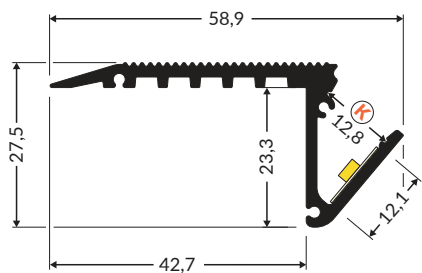

K → 200

diffuser K click
 kloz K klik
 Abdeckung K einclipsbar
 diffuseur K clic



anodized
 anodowany
 eloxiert
 surface anodisée



black painted
 czarny malowany
 schwarz lackiert
 peint en noir

1000 mm	J4000120	J4000102
2000 mm	J4000220	J4000202
3000 mm	J4000320	J4000302
4050 mm	J4000420	J4000402

end cap UP-BOLD12
 zaślepka UP-BOLD12
 Endkappe UP-BOLD12
 embout UP-BOLD12



silver srebrny silbern argent	black czarny schwarz noir
J4999940	J4999902

grey szary grau gris
J4999922

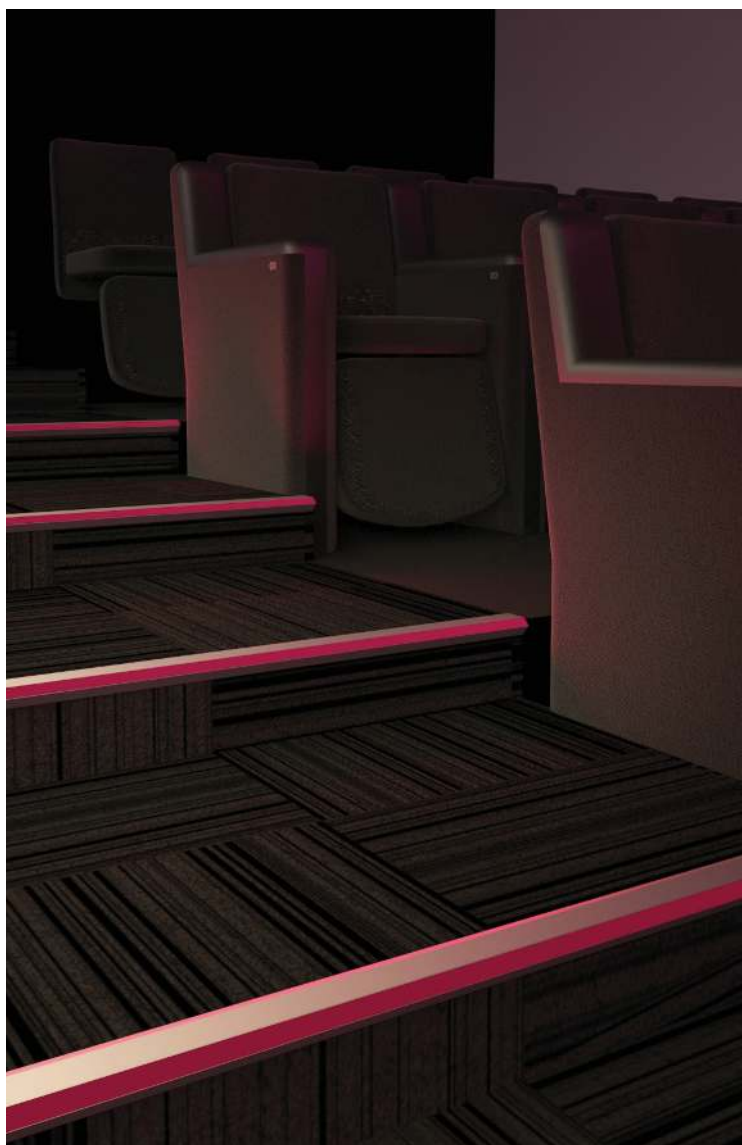

SKIRT10 AC2/Q9



max 10 mm



special application
specjalny
speziell
spécial



architectural
architektoniczne
architektonisch
pour le batiment

- elegant and robust skirting board for LED strips
- soft glow with a 60 P/m LED strip
- optimum light effect with a matt floor or carpet
- convenient installation
- space for concealing wires

- elegancka i solidna listwa przypodłogowa do taśm LED
- miękka łuna światła z taśmą LED 60 P/m
- optymalny efekt świetlny przy podłodze matowej, wykładzinie
- wygodny montaż
- miejsce na ukrycie przewodów

- elegante und robuste Sockelleiste für LED Streifen
- sanfter Lichtschein mit LED-Streifen 60 P/m
- optimaler Lichteffect mit mattem Fußboden oder Teppichboden
- komfortable Montage
- Platz zum Verstecken von Kabeln

- plinthe élégante et résistante pour les rubans LED
- effet lumineux doux avec le ruban LED 60 P/m
- effet de lumière optimal avec un sol mat ou une moquette
- installation pratique
- endroit pour cacher les fils



more
information



więcej
szczegółów



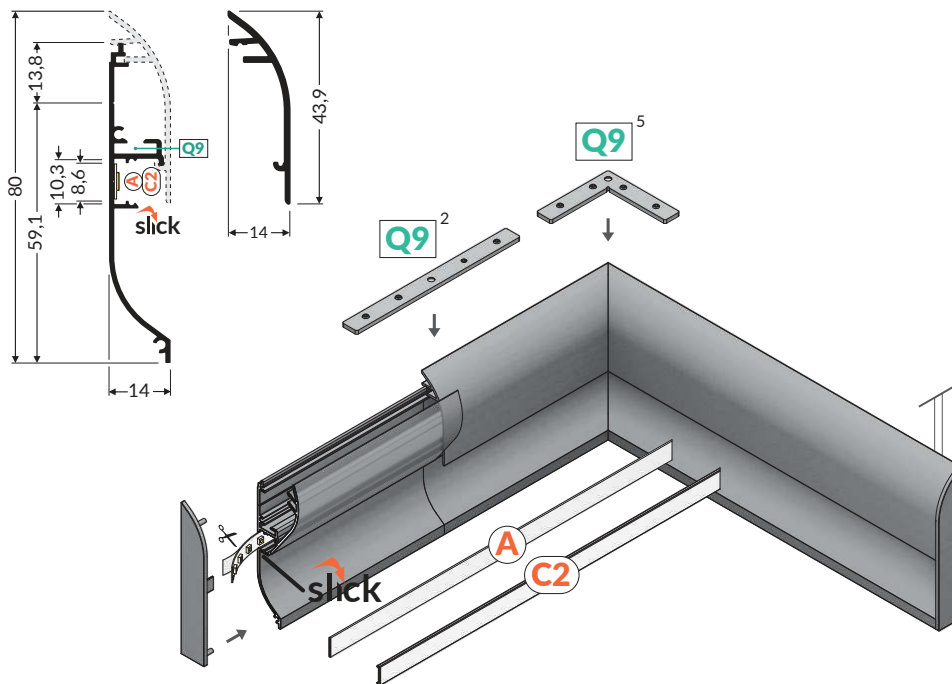

Technical manual
Instrukcja techniczna
Technische Anleitung
Manuel technique



LED profile SKIRT10
profil LED SKIRT10
LED Profil SKIRT10
profilé LED SKIRT10

	white painted biały malowany weiß lackiert peint en blanc	anodized anodowany eloxiert surface anodisée	raw aluminium surowe aluminium Rohaluminium aluminium brut
1000 mm	J2000101	J2000120	J2000100
2000 mm	J2000201	J2000220	J2000200
3000 mm	J2000301	J2000320	J2000300
4050 mm	J2000401	J2000420	J2000400

complementary profile SKIRT10
profil uzupełniający SKIRT10
Ergänzungsprofil SKIRT10
cache SKIRT10

	white painted biały malowany weiß lackiert peint en blanc	anodized anodowany eloxiert surface anodisée	raw aluminium surowe aluminium Rohaluminium aluminium brut
1000 mm	J2000501	J2000520	J2000500
2000 mm	J2000601	J2000620	J2000600
3000 mm	J2000701	J2000720	J2000700
4050 mm	J2000801	J2000820	J2000800

end cap SKIRT10
zaślepka SKIRT10
Endkappe SKIRT10
embout SKIRT10



white biały weiß blanc	silver srebrny silbern argent	grey szary grau gris
J2998901	J2998940	J2998922

Q9¹ → 203

connector Q9 90 deg bent
łącznik Q9 90 st gięty
Verbinder Q9 90 Grad gebogen
connecteur Q9 90 degrés pliable

Q9² → 203

connector Q9 180 deg
łącznik Q9 180 st
Verbinder Q9 180 Grad
connecteur Q9 180 degrés

Q9³ → 203

connector Q9 135 deg
łącznik Q9 135 st
Verbinder Q9 135 Grad
connecteur Q9 135 degrés

Q9⁴ → 203

connector Q9 120 deg
łącznik Q9 120 st
Verbinder Q9 120 Grad
connecteur Q9 120 degrés

Q9⁵ → 203

connector Q9 90 deg
łącznik Q9 90 st
Verbinder Q9 90 Grad
connecteur Q9 90 degrés

Q9⁶ → 203

connector Q9 60 deg
łącznik Q9 60 st
Verbinder Q9 60 Grad
connecteur Q9 60 degrés

Q9⁷ → 203

connector Q9 45 deg
łącznik Q9 45 st
Verbinder Q9 45 Grad
connecteur Q9 45 degrés

A → 194

diffuser A slide
klosz A wsuwany
Abdeckung A einziehbar
diffuseur A coulissant

C2 → 196

diffuser C2 click
klosz C2 klik
Abdeckung C2 einclipsbar
diffuseur C2 clic

BASE



special application
specjalny
speziell
spécial



architectural
architektoniczne
architektonisch
pour le bâtiment

- basic aluminium skirting board
- matches the SKIRT10 skirting board
- for all types of floors
- more durable and moisture-resistant (compared to MDF and wooden skirting boards)
- space for concealing wires

- podstawowa, aluminiowa listwa przypodłogowa
- stylistyczne uzupełnienie listwy przypodłogowej SKIRT10
- do wszystkich rodzajów podłóg
- wyższa trwałość i odporność na wilgoć (w porównaniu z listwami MDF i drewnianymi)
- miejsce na ukrycie przewodów

- Basis-Aluminium-Sockelleiste
- eine stilistische Ergänzung zur Sockelleiste SKIRT10
- für alle Arten von Fußboden
- höhere Haltbarkeit und Feuchtigkeitsbeständigkeit (im Vergleich zu MDF- und Holzleisten)
- Platz zum Verstecken von Leitungen

- plinthe en aluminium de base
- un complément stylistique à la plinthe SKIRT10
- pour tous les types de revêtements de sol
- meilleure durabilité et résistance à l'humidité (par rapport au MDF et aux plinthes en bois)
- endroit pour cacher les fils



more
information



więcej
szczegółów



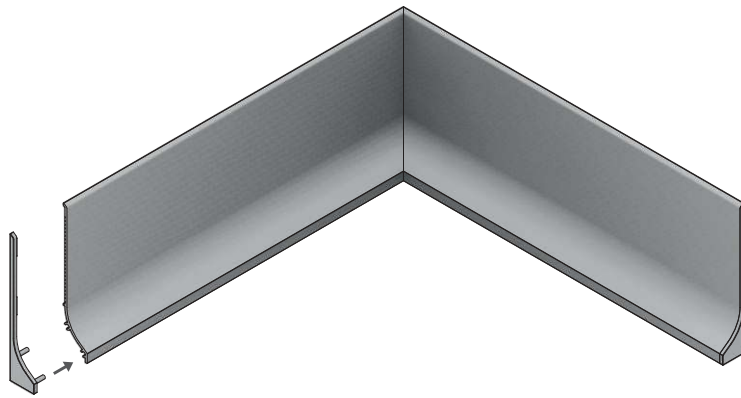
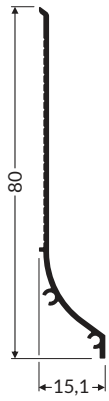

Technical manual
Instrukcja techniczna
Technische Anleitung
Manuel technique



white painted
biały malowany
weiß lackiert
peint en blanc



anodized
anodowany
eloxiert
surface anodisée



raw aluminium
surowe aluminium
Rohaluminium
aluminium brut

1000 mm	J1000101	J1000120	J1000100
2000 mm	J1000201	J1000220	J1000200
3000 mm	J1000301	J1000320	J1000300
4050 mm	J1000401	J1000420	J1000400

end cap BASE
zaślepka BASE
Endkappe BASE
embout BASE



white
biały
weiß
blanc
J1998901

silver
srebrny
silbern
argent
J1998940

grey
szary
grau
gris
J1998922



FIX12, FIX16



special application
specjalny
speziell
spécial



furniture
meblowe
Möbel-
mobilier

- the simplest installation of a LED strip
- function of radiator
- improves LED strip's adhesion
- minimal height of the profile
- budget profile, to be used without a diffuser
- maximum width of LED strip: 12 mm (FIX12) and 16 mm (FIX16)
- it can also function as a mounting profile:
FIX12 for profiles with X socket
FIX16 for profiles with T socket
outline

- najprostsze mocowanie taśmy LED
- funkcja radiatora
- trwalsze przyleganie taśmy LED
- minimalna wysokość profilu
- profil budżetowy, do użycia bez klosza
- maksymalna szerokość taśmy LED: 12 mm (FIX12) oraz 16 mm (FIX16)
- może pełnić również funkcję montażową:
FIX12 dla profili z gniazdem X
FIX16 dla profili z gniazdem T

- die einfachste Installation eines LED Streifens
- Wärmeabfuhrfunktion
- festeres Haften des LED Streifens
- die minimale Höhe des Profils
- ein Budget-Profil für die Anwendung ohne Abdeckung
- maximale Breite des LED Streifens: 12 mm (FIX12) und 16 mm (FIX16)
- es kann auch die Montagefunktion erfüllen:
FIX12 für die Profile mit Socket X
FIX16 für die Profile mit Socket T

- la plus simple installation de ruban LED
- fonction de dissipateur
- meilleure adhérence de ruban LED
- profilé d'une hauteur minimale
- profilé économique, à utiliser sans diffuseur
- largeur maximale de ruban LED : 12 mm (FIX12) et 16 mm (FIX16)
- il peut également effectuer une fonction d'assemblage:
FIX12 pour les profilés avec fixation X
FIX16 pour les profilés avec fixation T



FIX12



special application
specjalny
speziell
spécial

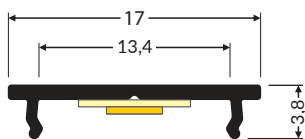

anodized
anodowany
eloxiert
surface anodisée



raw aluminium
surowe aluminium
Rohaluminium
aluminium brut

1000 mm	87020020	87020000
2000 mm	87030020	87030000
3000 mm	87040020	87040000
4050 mm	87050020	87050000



more
information



więcej
szczegółów

FIX16



special application
specjalny
speziell
spécial

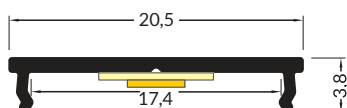

white painted
biały malowany
weiß lackiert
peint en blanc



anodized
anodowany
eloxiert
surface anodisée



black anodized
czarny anodowany
schwarz eloxiert
noir anodisé



raw aluminium
surowe aluminium
Rohaluminium
aluminium brut

1000 mm	C6010001	C6010020	C6010021	C6010000
2000 mm	C6020001	C6020020	C6020021	C6020000
3000 mm	C6030001	C6030020	C6030021	C6030000
4050 mm	C6040001	C6040020	C6040021	C6040000



more
information



więcej
szczegółów



ACCESSORIES
AKCESORIA
ZUBEHÖR
ACCESSOIRES

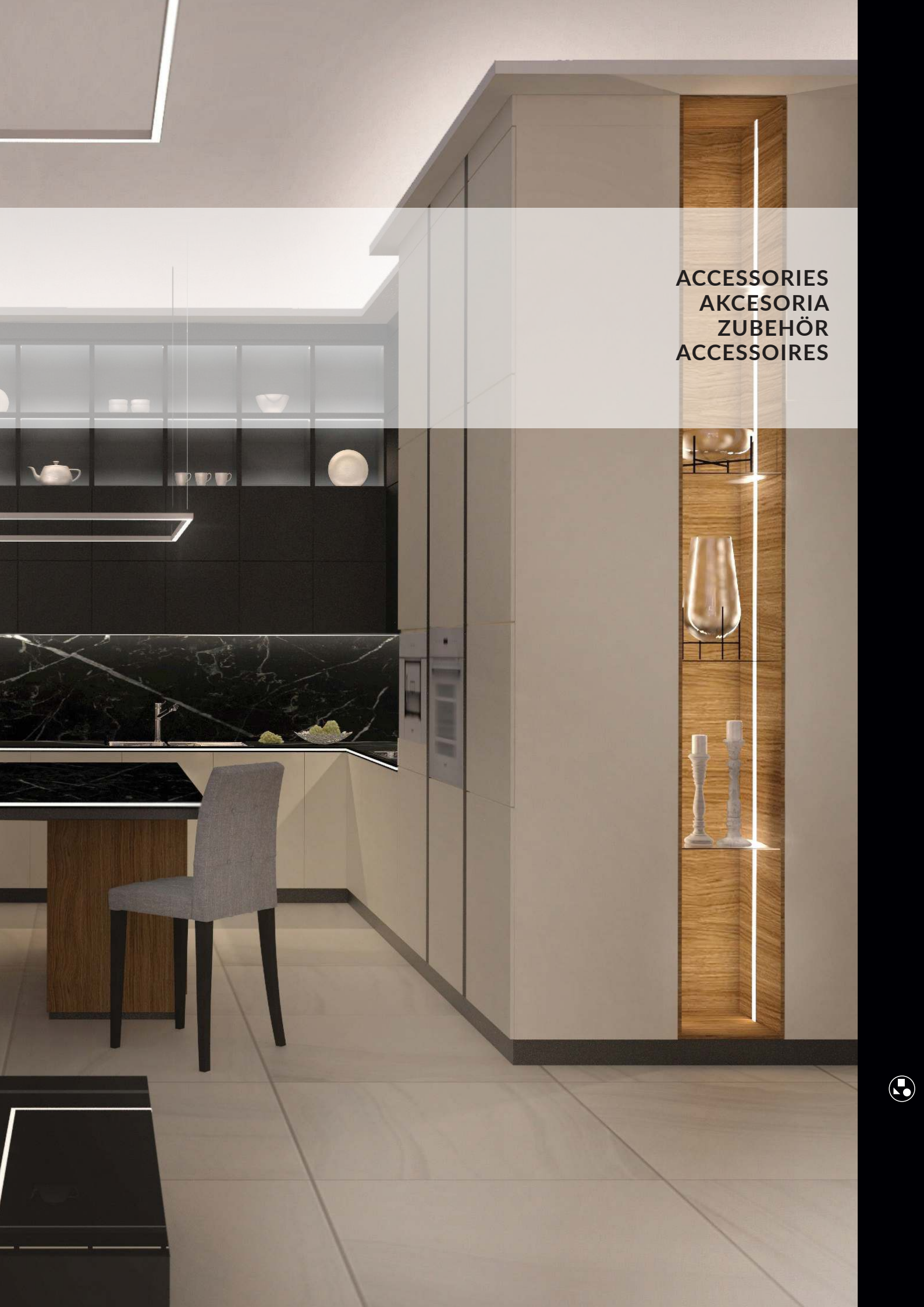

DIFFUSERS KLOSZE ABDECKUNG DIFFUSEURS

A

diffuser A slide
klosz A wsuwany
Abdeckung A einschiebbar
diffuseur A coulissant

SLIM8 AC2/Z → 32 UP-TILE10 A → 162
SMART10 AC2/Z → 34 BACK10 A/UX → 176
SMART-IN10 AC2/Z → 88 UP-MINI10 A → 182
OMNI10 AC2 → 136 SKIRT10 AC2/Q9 → 186

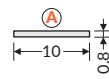

material / material / Material / matériel:

	PC	PP	PP
	transparent transparentny transparent transparent	frosted szron satiniert givré	opal mleczny opal opaque
1000 mm	89000616	89000639	89000638
2000 mm	89000716	89000739	89000738
3000 mm	-	89000839	-

A1

NEW

diffuser A1 slide
klosz A1 wsuwany
Abdeckung A1 einschiebbar
diffuseur A1 coulissant

GROOVE10.v2 A1C/U → 94
CORNER10.v2 A1C/U1 → 128
GLOW12 UP A1C → 140
GLOW12 DOWN A1C → 142

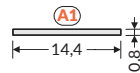

material / material / Material / matériel:

	PC	PP	PP
	transparent transparentny transparent transparent	frosted szron satiniert givré	opal mleczny opal opaque
1000 mm	J6000816	J6000839	J6000838
2000 mm	J6000916	J6000939	J6000938
3000 mm	-	J6001039	-

A9

diffuser A9 slide
klosz A9 wsuwany
Abdeckung A9 einschiebbar
diffuseur A9 coulissant

VARIO30-01 ACDE-9/TY → 59
VARIO30-02 ACDE-9/TY → 60
VARIO30-03 ACDE-9/TY → 63
COMBO30-01 ACDE-9 → 71
VARIO30-06 ACDE-9/U9 → 111
VARIO30-07 ACDE-9/U9 → 112
VARIO30-04 ACDE-9 → 153
VARIO30-05 ACDE-9 → 154

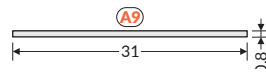

material / material / Material / matériel:

	PC	PP	PP
	transparent transparentny transparent transparent	frosted szron satiniert givré	opal mleczny opal opaque
1000 mm	V3000116	V3000139	V3000138
2000 mm	V3000216	V3000239	V3000238
3000 mm	-	V3000339	-

B

diffuser B slide
klosz B wsuwany
Abdeckung B einschiebbar
diffuseur B coulissant

UNI12 BCD/U → 38
SURFACE10 BC/UX → 40
SURFACE10.v2 BC/U → 42
SMART16 BC3/U4 → 48
GROOVE10 BC/UX → 92
GROOVE14.v2 BC3/Y → 98
DEEP10 BC/UX → 102
SMART-IN16 BC3/U4 → 104
QUARTER10 BD/U6 → 120
CORNER10 BC/UX → 126
FRAME14 BC/Q → 144
SMOOTH12 BC/Q9 → 146
WALLE12 BCD → 180

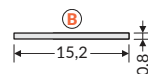

material / material / Material / matériel:

	PC	PP	PP
	transparent transparentny transparent transparent	frosted szron satiniert givré	opal mleczny opal opaque
1000 mm	76000116	76000139	76000138
2000 mm	76000216	76000239	76000238
3000 mm	-	76000339	-



diffuser C click
klosz C klik
Abdeckung C einclipsbar
diffuseur C clic

BEGTON12 J/S → 36
UNI12 BCD/U → 38
SURFACE10 BC/UX → 40
SURFACE10.v2 BC/U → 42
GROOVE10 BC/UX → 92
GROOVE10.v2 A1C/U → 94
DEEP10 BC/UX → 102
CORNER10 BC/UX → 126
CORNER10.v2 A1C/U1 → 128
GLOW12 UP A1C → 140
GLOW12 DOWN A1C → 142

FRAME14 BC/Q → 144
SMOOTH12 BC/Q9 → 146
UNI-TILE12 C → 164
ARC12 CD/U5 → 170
PEN12 CJ → 174
WAY10 C → 178
WALLE12 BCD → 180

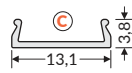

material / materiał / Material / matériel:

	PMMA	PMMA	PMMA
	transparent transparentny transparent transparent	opal mleczny opal opaque	black czarny schwarz noir
1000 mm	76320000	76320038	76320041
2000 mm	76330000	76330038	76330041
3000 mm	76650000	76650038	76650041
4100 mm	76660000	76660038	76660041

scissors for cutting diffusers
nożyce do cięcia kloszy
Schere zum Schneiden
von Abdeckungen
ciseaux pour couper
les diffuseurs



73046028

reel
rolka
Rolle
rouleau

length:
długość
Länge:
longeur:
20 000 mm (20 m)

material / materiał / Material / matériel:

PMMA



opal
mleczny
opal
opaque
763600385



diffuser C click lens gen2
klosz C klik soczewka gen2
Abdeckung C einclipsbar Linse gen2
diffuseur C clic lentille gen2

UNI12 BCD/U → 38
SURFACE10 BC/UX → 40
SURFACE10.v2 BC/U → 42
GROOVE10 BC/UX → 92
GROOVE10.v2 A1C/U → 94
DEEP10 BC/UX → 102
CORNER10 BC/UX → 126
CORNER10.v2 A1C/U1 → 128

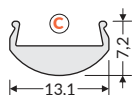

material / materiał / Material / matériel:

PC



2000 mm 76810016

transparent
transparentny
transparent
transparent



diffuser C1 click
klosz C1 klik
Abdeckung C1 einclipsbar
diffuseur C1 clic

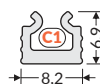

material / materiał / Material / matériel:

PMMA



1000 mm H8050038
2000 mm H8060038
3000 mm H8070038
4000 mm H8080038

opal
mleczny
opal
opaque

HI8 C1 → 86

C2

diffuser C2 click
klosz C2 klik
Abdeckung C2 einclipsbar
diffuseur C2 clic

SLIM8 AC2/Z → 32
SMART10 AC2/Z → 34
SMART-IN10 AC2/Z → 88
OMNI10 AC2 → 136
SKIRT10 AC2/Q9 → 186

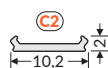

material / materiał / Material / matériel:

	PMMA	PMMA	PMMA
	transparent transparentny transparent transparent	opal mleczny opal opaque	black czarny schwarz noir
1000 mm	89000116	89000138	-
2000 mm	89000216	89000238	89000241
3000 mm	89000316	89000338	-
4100 mm	89000416	89000438	-

scissors for cutting diffusers
nożyce do cięcia kloszy
Schere zum Schneiden
von Abdeckungen
ciseaux pour couper
les diffuseurs



reel
rolka
Rolle
rouleau

length:
długość
Länge:
longueur:
20 000 mm (20 m)

material / materiał / Material / matériel:

	PMMA	PMMA
	opal mleczny opal opaque	black czarny schwarz noir
	89000538S	89000541S

73046028

C3

diffuser C3 click
klosz C3 klik
Abdeckung C3 einclipsbar
diffuseur C3 clic

SMART16 BC3/U4 → 48
GROOVE14.v2 BC3/Y → 98
SMART-IN16 BC3/U4 → 104



material / materiał / Material / matériel:

	PMMA	PMMA	PMMA
	transparent transparentny transparent transparent	opal mleczny opal opaque	black czarny schwarz noir
1000 mm	F1000116	F1000138	F1000141
2000 mm	F1000216	F1000238	F1000241
3000 mm	F1000316	F1000338	F1000341
4000 mm	F1000416	F1000438	F1000441

C4

diffuser C4 click
klosz C4 klik
Abdeckung C4 einclipsbar
diffuseur C4 clic

COMBO30-03 C4/Q9 → 73
HIDE10 C4 → 148

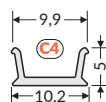

material / materiał / Material / matériel:

	PC
	opal mleczny opal opaque
1000 mm	H7000538
2000 mm	H7000638
3000 mm	H7000738
4000 mm	H7000838

C9

diffuser C9 click
klosz C9 klik
Abdeckung C9 einclipsbar
diffuseur C9 clic

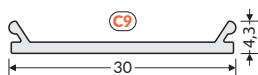

material / materiał / Material / matériel:

PMMA

PMMA

PMMA

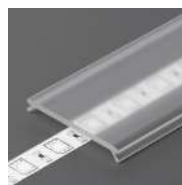

transparent
transparentny
transparent
transparent

opal
mleczny
opal
opaque

black
czarny
schwarz
noir

1000 mm	V3450016
2000 mm	V3460016
3000 mm	V3470016
4100 mm	V3480016

V3450038
V3460038
V3470038
V3480038

V3450041
V3460041
V3470041
V3480041

C10¹

diffuser C10 click OPAL
klosz C10 klik OPAL
Abdeckung C10 einclipsbar OPAL
diffuseur C10 clic OPAL

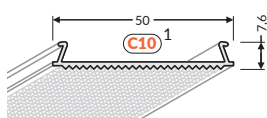

material / materiał / Material / matériel:

PMMA

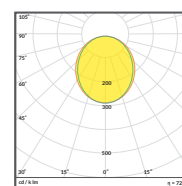
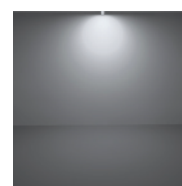
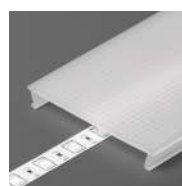

OPAL

LOWI C10 → 78
PHIL53 C10 → 80
PHIL
RECESSED / WPUST / EINBAU / À ENCASTRER C10 → 116

1000 mm	63680038
2000 mm	63690038
3000 mm	63760038
4000 mm	63700038

C10²

diffuser C10 click NARROW
klosz C10 klik NARROW
Abdeckung C10 einclipsbar NARROW
diffuseur C10 clic NARROW

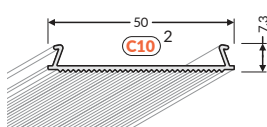

material / materiał / Material / matériel:

PC

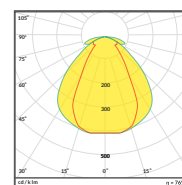
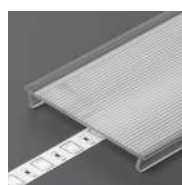

NARROW

LOWI C10 → 78
PHIL53 C10 → 80
PHIL
RECESSED / WPUST / EINBAU / À ENCASTRER C10 → 116

1000 mm	63610038
2000 mm	63620000
3000 mm	63790000
4050 mm	63800000

C10³

diffuser C10 click WIDE
klosz C10 klik WIDE
Abdeckung C10 einclipsbar WIDE
diffuseur C10 clic WIDE

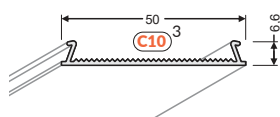

material / materiał / Material / matériel:

PC

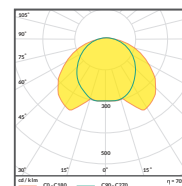
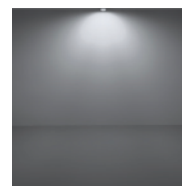
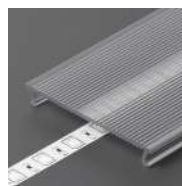

WIDE

LOWI C10 → 78
PHIL53 C10 → 80
PHIL
RECESSED / WPUST / EINBAU / À ENCASTRER C10 → 116

1000 mm	63580000
2000 mm	63590000
3000 mm	63770000
4000 mm	63780000

D

diffuser D click
klosz D klik
Abdeckung D einclipsbar
diffuseur D clic

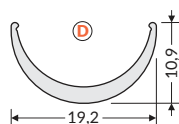

material / materiał / Material / matériel:

PMMA



opal
mleczny
opal
opaque

1000 mm	A1130038
2000 mm	A1140038
3000 mm	A1150038
4100 mm	A1160038

UNI12 BCD/U → 38
QUARTER10 BD/U6 → 120
ARC12 CD/U5 → 170
WALLE12 BCD → 180

D9

diffuser D9 click
klosz D9 klik
Abdeckung D9 einclipsbar
diffuseur D9 clic

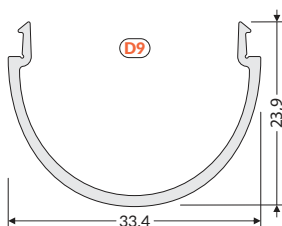

material / materiał / Material / matériel:

PMMA



opal
mleczny
opal
opaque

1000 mm	V3490038
2000 mm	V3500038
3000 mm	V3510038
4100 mm	V3520038

VARIO30-01 ACDE-9/TY → 59
VARIO30-02 ACDE-9/TY → 60
VARIO30-03 ACDE-9/TY → 63
COMBO30-01 ACDE-9 → 70
NAMI23 CD-9 → 76
VARIO30-06 ACDE-9/U9 → 111
VARIO30-07 ACDE-9/U9 → 112
VARIO30-04 ACDE-9 → 153
VARIO30-05 ACDE-9 → 154

PMMA

end cap D9
zaślepka D9
Endkappe D9
embout D9



opal
mleczny
opal
opaque

V4980038

E

diffuser E slide
klosz E wsuwany
Abdeckung E einschiebbar
diffuseur E coulissant

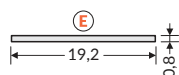

material / materiał / Material / matériel:

PC



transparent
transparentny
transparent
transparent

1000 mm	A2000116
2000 mm	A2000216
3000 mm	-

SURFACE14 EE7F/TY → 44
SURFACE14.v2 EE7F/Y → 46
LINEA20 EE7F/TY → 50
GROOVE14 EE7F/TY → 96
LINEA-IN20 EE7F/U7 → 106
CABI12 E → 122
CABI12 DUO E → 124
CORNER14 EE7F/TY → 130
CORNER12.v2 EF/U → 132
LINEA-IN20 TRIMLESS EE7F → 150

PP



frosted
szron
satiniert
givré

1000 mm	A2000139
2000 mm	A2000239
3000 mm	A2000339

PP



opal
mleczny
opal
opaque

1000 mm	A2000138
2000 mm	A2000238
3000 mm	-

E7

diffuser E7 click
klosz E7 klik
Abdeckung E7 einclipsbar
diffuseur E7 clic

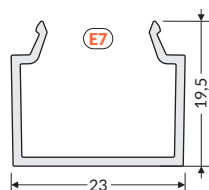

material / materiał / Material / matériel:

PMMA

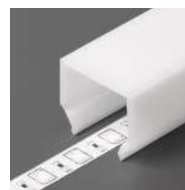

opal
mleczny
opal
opaque

1000 mm	C1070038
2000 mm	C1080038
3000 mm	C1090038
4050 mm	C1100038

SURFACE14 EE7F/TY → 44
SURFACE14.v2 EE7F/Y → 46
LINEA20 EE7F/TY → 50
GROOVE14 EE7F/TY → 96
LINEA-IN20 EE7F/U7 → 106
CORNER14 EE7F/TY → 130
LINEA-IN20 TRIMLESS EE7F → 150

PMMA

end cap E7
zaślepka E7
Endkappe E7
embout E7



opal
mleczny
opal
opaque

C1840038

E9

diffuser E9 click
klosz E9 klik
Abdeckung E9 einclipsbar
diffuseur E9 clic

VARIO30-01 ACDE-9/TY → 59
VARIO30-02 ACDE-9/TY → 60
VARIO30-03 ACDE-9/TY → 63
COMBO30-01 ACDE-9 → 70
NAMI23 CD-9 → 76
VARIO30-06 ACDE-9/U9 → 111
VARIO30-07 ACDE-9/U9 → 112
VARIO30-04 ACDE-9 → 153
VARIO30-05 ACDE-9 → 154

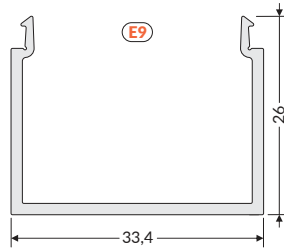

1000 mm	V3530038
2000 mm	V3540038
3000 mm	V3550038
4100 mm	V3560038

material / materiał / Material / matériel:
PC

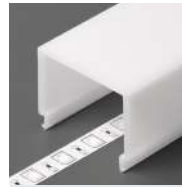

opal
mleczny
opal
opaque

end cap E9
zaślepka E9
Endkappe E9
embout E9

PMMA



opal
mleczny
opal
opaque

V4990038

F

diffuser F click
klosz F klik
Abdeckung F einclipsbar
diffuseur F clic

SURFACE14 EE7F/TY → 44
SURFACE14.v2 EE7F/Y → 46
LINEA20 EE7F/TY → 50
GROOVE14 EE7F/TY → 96
DIAGONAL14 F/TY → 100
LINEA-IN20 EE7F/U7 → 106
CORNER14 EE7F/TY → 130
CORNER12.v2 EF/U → 132
LINEA-IN20 TRIMLESS EE7F → 150



1000 mm	A2050016
2000 mm	A2060016
3000 mm	A2150016
4100 mm	A2160016

material / materiał / Material / matériel:

PMMA



transparent
transparentny
transparent
transparent

PMMA

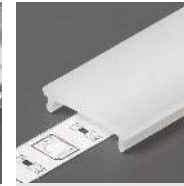

opal
mleczny
opal
opaque

PMMA



black
czarny
schwarz
noir

1000 mm	A2050016	A2050038	A2050041
2000 mm	A2060016	A2060038	A2060041
3000 mm	A2150016	A2150038	A2150041
4100 mm	A2160016	A2160038	A2160041

material / materiał / Material / matériel:

PMMA

scissors for cutting diffusers
nożyce do cięcia kloszy
Schere zum Schneiden
von Abdeckungen
ciseaux pour couper
les diffuseurs

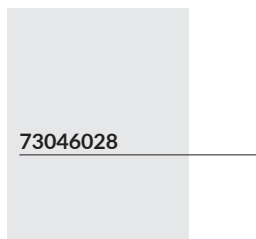

73046028



reel
rolka
Rolle
rouleau

length:
długość
Länge:
longueur:
20 000 mm (20 m)



opal
mleczny
opal
opaque

A2210038S

NEW
20 m

G

diffuser G slide
klosz G wsuwany
Abdeckung G einschiebbar
diffuseur G coulissant



1000 mm	84000116
2000 mm	84000216
3000 mm	-

material / materiał / Material / matériel:

PC



transparent
transparentny
transparent
transparent

PP

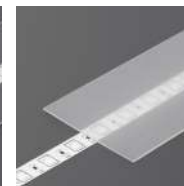

frosted
szron
satinert
givré

PP



opal
mleczny
opal
opaque

1000 mm	84000116	84000139	84000138
2000 mm	84000216	84000239	84000238
3000 mm	-	84000339	-

WIDE24 G/W → 56

H

diffuser H slide
klosz H wsuwany
Abdeckung H einschiebbar
diffuseur H coulissant

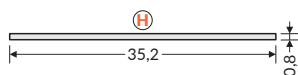

material / materiał / Material / matériel:

	PC	PP	PP
	transparent transparentny transparent transparent	frosted szron satiniert givré	opal mleczny opal opaque
1000 mm	23000116	23000139	23000138
2000 mm	23000216	23000239	23000238
3000 mm	-	23000339	-

FLAT8 H/UX → 114

I

diffuser I click
klosz I klik
Abdeckung I einclipsbar
diffuseur I clic

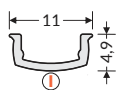

material / materiał / Material / matériel:

	PC	PC
	frosted szron satiniert givré	opal mleczny opal opaque
1000 mm	86050000	86050038
2000 mm	86060000	86060038
3000 mm	86510000	86510038
4100 mm	86520000	86520038

PEN8 I → 172

J

diffuser J slide
klosz J wsuwany
Abdeckung J einschiebbar
diffuseur J coulissant



material / materiał / Material / matériel:

	PC	PP	PP
	transparent transparentny transparent transparent	frosted szron satiniert givré	opal mleczny opal opaque
1000 mm	70000116	70000139	70000138
2000 mm	70000216	70000239	70999238
3000 mm	-	70000339	-

BEGTON12 J/S → 36

BEGTIN12 J/S → 90

PEN12 CJ → 174

K

diffuser K click
klosz K klik
Abdeckung K einclipsbar
diffuseur K clic

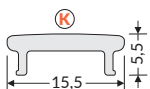

material / materiał / Material / matériel:

	PC
	opal mleczny opal opaque
1000 mm	B1030038
2000 mm	B1040038
3000 mm	B1050038
4100 mm	B1060038

FLOOR8 K → 158

FLOOR12 K/U → 160

UP-BOLD12 K → 184



MOUNTINGS MOCOWANIA HALTER FIXATIONS

Q¹

connector Q 90 deg bent
łącznik Q 90 st gięty
Verbinder Q 90 Grad gebogen
connecteur Q 90 degrés plié

FRAME14 BC/Q → 144

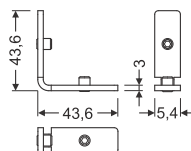

material: zinc coated steel
materiał: stal ocynkowana
Material: verzinkter Stahl
matériau: acier galvanisé

C3960030

Q²

connector Q 180 deg
łącznik Q 180 st
Verbinder Q 180 Grad
connecteur Q 80 degrés

FRAME14 BC/Q → 144

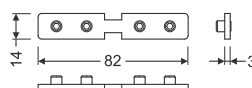

material: zinc coated steel
materiał: stal ocynkowana
Material: verzinkter Stahl
matériau: acier galvanisé

C3990030

Q³

connector Q 135 deg
łącznik Q 135 st
Verbinder Q 135 Grad
connecteur Q 135 degrés

FRAME14 BC/Q → 144

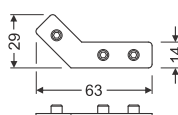

material: zinc coated steel
materiał: stal ocynkowana
Material: verzinkter Stahl
matériau: acier galvanisé

C3980030

Q⁴

connector Q 90 deg
łącznik Q 90 st
Verbinder Q 90 Grad
connecteur Q 90 degrés

FRAME14 BC/Q → 144

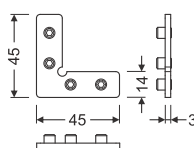

material: zinc coated steel
materiał: stal ocynkowana
Material: verzinkter Stahl
matériau: acier galvanisé

C3970030

Q9¹

connector Q9 90 deg bent
 łącznik Q9 90 st gięty
 Verbinder Q9 90 Grad gebogen
 connecteur Q9 90 degrés pliable

COMBO30-02 **Q9** → 73
 COMBO30-03 **C4/Q9** → 73
 SMOOTH12 **BC/Q9** → 146
 SKIRT10 **AC2/Q9** → 186

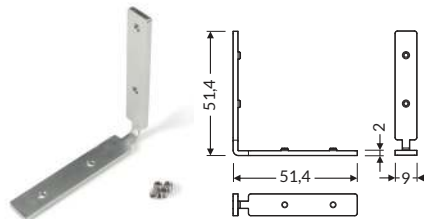

material: zinc coated steel
 materiał: stal ocynkowana
 Material: verzinkter Stahl
 matériel: acier galvanisé

V5999519S**Q9**²

connector Q9 180 deg
 łącznik Q9 180 st
 Verbinder Q9 180 Grad
 connecteur Q9 180 degrés

COMBO30-02 **Q9** → 73
 COMBO30-03 **C4/Q9** → 73
 SMOOTH12 **BC/Q9** → 146
 SKIRT10 **AC2/Q9** → 186

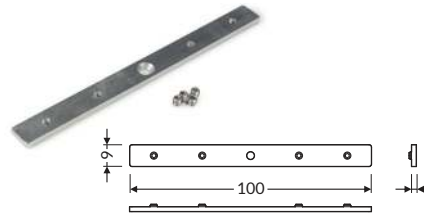

material: zinc coated steel
 materiał: stal ocynkowana
 Material: verzinkter Stahl
 matériel: acier galvanisé

V5999819S**Q9**³

connector Q9 135 deg
 łącznik Q9 135 st
 Verbinder Q9 135 Grad
 connecteur Q9 135 degrés

COMBO30-02 **Q9** → 73
 COMBO30-03 **C4/Q9** → 73
 SMOOTH12 **BC/Q9** → 146
 SKIRT10 **AC2/Q9** → 186

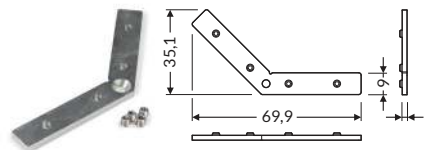

material: zinc coated steel
 materiał: stal ocynkowana
 Material: verzinkter Stahl
 matériel: acier galvanisé

V5999719S**Q9**⁴

connector Q9 120 deg
 łącznik Q9 120 st
 Verbinder Q9 120 Grad
 connecteur Q9 120 degrés

COMBO30-02 **Q9** → 73
 COMBO30-03 **C4/Q9** → 73
 SMOOTH12 **BC/Q9** → 146
 SKIRT10 **AC2/Q9** → 186

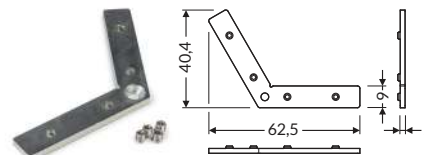

material: zinc coated steel
 materiał: stal ocynkowana
 Material: verzinkter Stahl
 matériel: acier galvanisé

V5999619S**Q9**⁵

connector Q9 90 deg
 łącznik Q9 90 st
 Verbinder Q9 90 Grad
 connecteur Q9 90 degrés

COMBO30-02 **Q9** → 73
 COMBO30-03 **C4/Q9** → 73
 SMOOTH12 **BC/Q9** → 146
 SKIRT10 **AC2/Q9** → 186

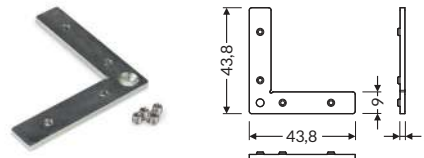

material: zinc coated steel
 materiał: stal ocynkowana
 Material: verzinkter Stahl
 matériel: acier galvanisé

V5999419S**Q9**⁶

connector Q9 60 deg
 łącznik Q9 60 st
 Verbinder Q9 60 Grad
 connecteur Q9 60 degrés

COMBO30-02 **Q9** → 73
 COMBO30-03 **C4/Q9** → 73
 SMOOTH12 **BC/Q9** → 146
 SKIRT10 **AC2/Q9** → 186

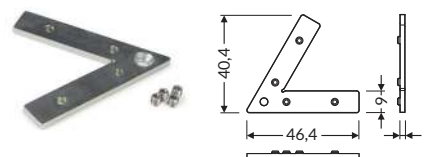

material: zinc coated steel
 materiał: stal ocynkowana
 Material: verzinkter Stahl
 matériel: acier galvanisé

V5999319S**Q9**⁷

connector Q9 45 deg
 łącznik Q9 45 st
 Verbinder Q9 45 Grad
 connecteur Q9 45 degrés

COMBO30-02 **Q9** → 73
 COMBO30-03 **C4/Q9** → 73
 SMOOTH12 **BC/Q9** → 146
 SKIRT10 **AC2/Q9** → 186

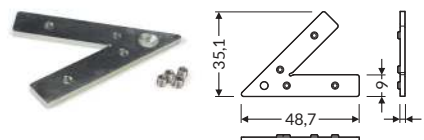

material: zinc coated steel
 materiał: stal ocynkowana
 Material: verzinkter Stahl
 matériel: acier galvanisé

V5999219S

holder Q9 for sling
 uchwyt Q9 do zawiesia
 Halter Q9 für Abhängung
 fixation Q9 pour suspension

material: zinc coated steel
 materiał: stal ocynkowana
 Material: verzinkter Stahl
 matériel: acier galvanisé

**V5999919S**

screw for Q9 connector
 wkręt do łącznika Q9
 Schraube für Verbinder Q9
 vis pour connecteur Q9

COMBO30-02 **Q9** → 73

**V5999830**

S¹

mounting plate S
uchwył S
Halter S
fixation S

BEGTON12 J/S → 36
BEGTIN12 J/S → 90

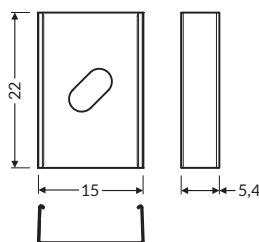

material: stainless steel
materiał: stal nierdzewna
Material: rostfreier Stahl
matériau: acier inoxydable

white		black
biały		czarny
weiß		schwarz
blanc	inox	noir
C7980001	C7980019	C7980002

S²

mounting plate S cone
uchwył S cone
Halter S cone
fixation S cône

BEGTON12 J/S → 36
BEGTIN12 J/S → 90

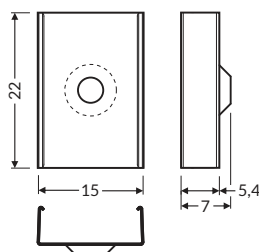

material: stainless steel
materiał: stal nierdzewna
Material: rostfreier Stahl
matériau: acier inoxydable

white		black
biały		czarny
weiß		schwarz
blanc	inox	noir
C7950001	C7950019	C7950002

T¹

mounting plate T
uchwył T
Halter T
fixation T

SURFACE14 EE7F/TY → 44
LINEA20 EE7F/TY → 50
VARIO30-01 ACDE-9/TY → 59
VARIO30-02 ACDE-9/TY → 60
VARIO30-03 ACDE-9/TY → 63

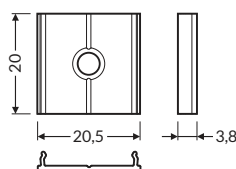

GROOVE14 EE7F/TY → 96
DIAGONAL14 F/TY → 100
CORNER14 EE7F/TY → 130

material: aluminium
materiał: aluminium
Material: Aluminium
matériau: aluminium

raw aluminium
surowe aluminium
Rohaluminium
aluminium brut
C6960000

T²

connector T 180 deg
łącznik T 180 st
Verbinder T 180 Grad
connecteur T 180 degrés

SURFACE14 EE7F/TY → 44
LINEA20 EE7F/TY → 50
VARIO30-01 ACDE-9/TY → 59
VARIO30-02 ACDE-9/TY → 60
VARIO30-03 ACDE-9/TY → 63

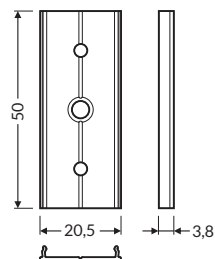

GROOVE14 EE7F/TY → 96
DIAGONAL14 F/TY → 100
CORNER14 EE7F/TY → 130

material: aluminium
materiał: aluminium
Material: Aluminium
matériau: aluminium

raw aluminium
surowe aluminium
Rohaluminium
aluminium brut
C6990000

U¹

mounting plate U
uchwył U
Halter U
fixation U

UNI12 BCD/U → 38
SURFACE10 BC/UX → 40
SURFACE10.v2 BC/U → 42
GROOVE10 BC/UX → 92
GROOVE10.v2 A1C/U → 94

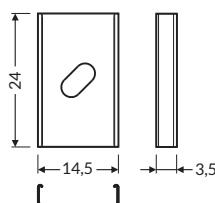

DEEP10 BC/UX → 102
FLAT8 H/UX → 114
CORNER10 BC/UX → 126
CORNER12.v2 EF/U → 132
FLOOR12 K/U → 160

BACK10 A/UX → 176

material: stainless steel
materiał: stal nierdzewna
Material: rostfreier Stahl
matériau: acier inoxydable

inox
76380000

U²

mounting plate U cone
uchwył U cone
Halter U cone
fixation U cône

UNI12 BCD/U → 38
SURFACE10 BC/UX → 40
SURFACE10.v2 BC/U → 42
GROOVE10 BC/UX → 92
GROOVE10.v2 A1C/U → 94

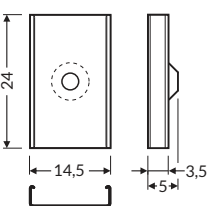

DEEP10 BC/UX → 102
FLAT8 H/UX → 114
CORNER10 BC/UX → 126
CORNER12.v2 EF/U → 132
FLOOR12 K/U → 160

BACK10 A/UX → 176

material: stainless steel
materiał: stal nierdzewna
Material: rostfreier Stahl
matériau: acier inoxydable

inox
76620000

U1¹

mounting plate U1
uchwyt U1
Halter U1
fixation U1

CORNER10.v2 A1C/U1 → 128

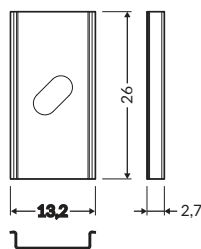

material: stainless steel
materiał: stal nierdzewna
Material: rostfreier Stahl
matériel: acier inoxydable

inox
A2090019

U4¹

mounting plate U4
uchwyt U4
Halter U4
fixation U4

SMART16 BC3/U4 → 48
SMART-IN16 BC3/U4 → 104

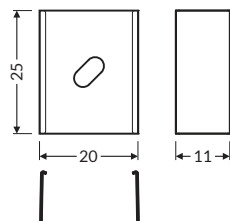

material: stainless steel
materiał: stal nierdzewna
Material: rostfreier Stahl
matériel: acier inoxydable

white		black
biały		czarny
weiß		schwarz
blanc	inox	noir
F1970001	F1970019	F1970002

U4²

mounting plate U4 cone
uchwyt U4 cone
Halter U4 cone
fixation U4 cône

SMART16 BC3/U4 → 48
SMART-IN16 BC3/U4 → 104

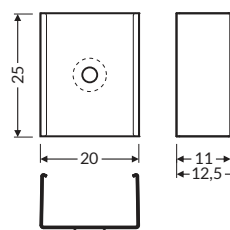

material: stainless steel
materiał: stal nierdzewna
Material: rostfreier Stahl
matériel: acier inoxydable

white		black
biały		czarny
weiß		schwarz
blanc	inox	noir
F1980001	F1980019	F1980002

U4³

mounting plate U4 spring
uchwyt U4 sprężyna
Halter U4 Feder
fixation U4 ressort

SMART-IN16 BC3/U4 → 104

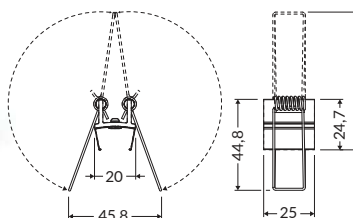

material: stainless steel, aluminium
materiał: stal nierdzewna, aluminium
Material: rostfreier Stahl, Aluminium
matériel: acier inoxydable, aluminium

inox
F6009819S

U5¹

mounting plate U5 cone
uchwyt U5 cone
Halter U5 cone
fixation U5 cône

ARC12 CD/U5 → 170

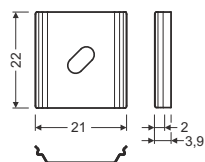

material: stainless steel
materiał: stal nierdzewna
Material: rostfreier Stahl
matériel: acier inoxydable

inox
B2940019

U5²

mounting plate U5 side
uchwyt U5 boczny
Halter U5 seitlich
fixation U5 latérale

ARC12 CD/U5 → 170

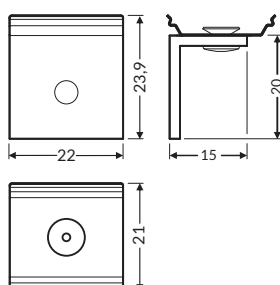

material: stainless steel
materiał: stal nierdzewna
Material: rostfreier Stahl
matériel: acier inoxydable

white	raw aluminium	black
biały	surowe aluminium	czarny
weiß	Rohaluminium	schwarz
blanc	aluminium brut	noir
B2920001	B2920000	B2920002

U6¹

mounting plate U6
uchwyt U6
Halter U6
fixation U6

QUARTER10 BD/U6 → 120

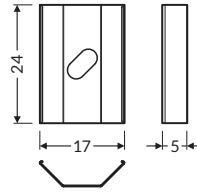

material: stainless steel
materiał: stal nierdzewna
Material: rostfreier Stahl
matériel: acier inoxydable

inox
D3960019

U6²

mounting plate U6 cone
uchwyt U6 cone
Halter U6 cone
fixation U6 cône

QUARTER10 BD/U6 → 120

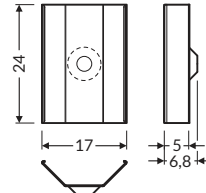

material: stainless steel
materiał: stal nierdzewna
Material: rostfreier Stahl
matériel: acier inoxydable

inox
D3970019

U7¹

mounting plate U7
uchwyt U7
Halter U7
fixation U7

LINEA-IN20 EE7F/U7 → 106

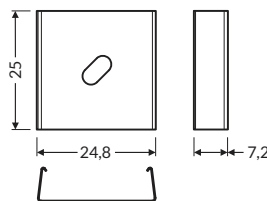

material: stainless steel
materiał: stal nierdzewna
Material: rostfreier Stahl
matériel: acier inoxydable

inox
E4960019

U7²

mounting plate U7 cone
uchwyt U7 cone
Halter U7 cone
fixation U7 cône

LINEA-IN20 EE7F/U7 → 106

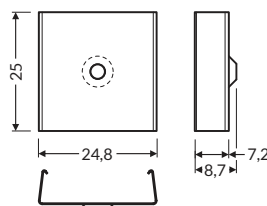

material: stainless steel
materiał: stal nierdzewna
Material: rostfreier Stahl
matériel: acier inoxydable

inox
E4970019

U7³

mounting plate U7 spring
uchwyt U7 sprężyna
Halter U7 Feder
fixation U7 ressort

LINEA-IN20 EE7F/U7 → 106

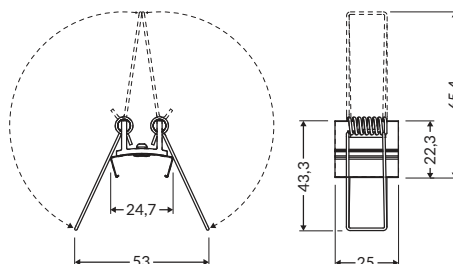

material: stainless steel
materiał: stal nierdzewna
Material: rostfreier Stahl
matériel: acier inoxydable

inox
E4880019S

U9¹

mounting plate U9
uchwyt U9
Halter U9
fixation U9

VARIO30-06 ACDE-9/U9 → 111
VARIO30-07 ACDE-9/U9 → 112

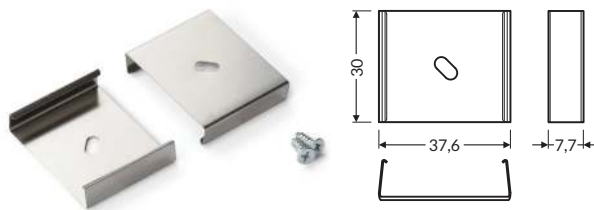

material: stainless steel
materiał: stal nierdzewna
Material: rostfreier Stahl
matériel: acier inoxydable

inox
V4840019

U9²

mounting plate U9 cone
uchwyt U9 cone
Halter U9 cone
fixation U9 cône

VARIO30-06 ACDE-9/U9 → 111
VARIO30-07 ACDE-9/U9 → 112

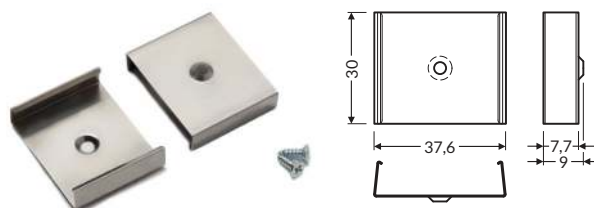

material: stainless steel
materiał: stal nierdzewna
Material: rostfreier Stahl
matériel: acier inoxydable

inox
V4850019

U9³

mounting plate U9 spring
uchwyt U9 sprężyna
Halter U9 Feder
fixation U9 ressort

VARIO30-06 ACDE-9/U9 → 111
VARIO30-07 ACDE-9/U9 → 112

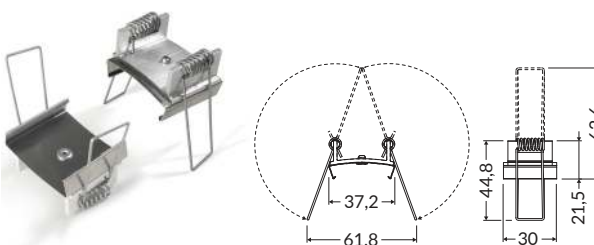

material: stainless steel
materiał: stal nierdzewna
Material: rostfreier Stahl
matériel: acier inoxydable

inox
V4860019S

W

mounting plate W cone
uchwyt W cone
Halter W cone
fixation W cône

WIDE24 G/W → 56

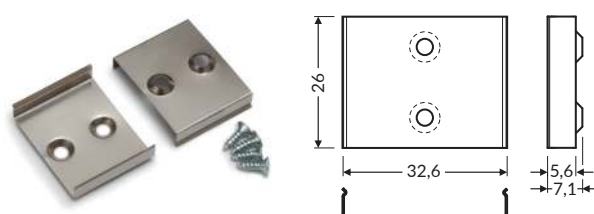

material: stainless steel
materiał: stal nierdzewna
Material: rostfreier Stahl
matériel: acier inoxydable

white		black
biały		czarny
weiß		schwarz
blanc	inox	noir
84510001	84510019	84510002

X¹

mounting plate X
uchwyt X
Halter X
fixation X
SURFACE10 BC/UX → 40
GROOVE10 BC/UX → 92
DEEP10 BC/UX → 102
FLAT8 H/UX → 114
CORNER10 BC/UX → 126
BACK10 A/UX → 176

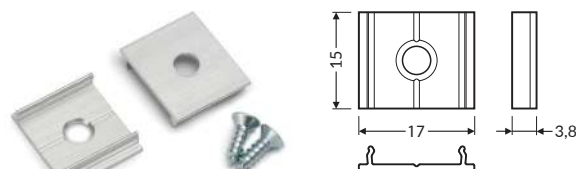

material: aluminium
materiał: aluminium
Material: Aluminium
matériel: aluminium

raw aluminium
surowe aluminium
Rohaluminium
aluminium brut
76260000

X²

connector X 180 deg
łącznik X 180 st
Verbinder X 180 Grad
connecteur X 180 degrés
SURFACE10 BC/UX → 40
GROOVE10 BC/UX → 92
DEEP10 BC/UX → 102
FLAT8 H/UX → 114
CORNER10 BC/UX → 126
BACK10 A/UX → 176

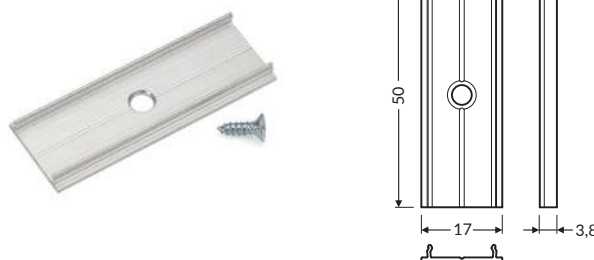

material: aluminium
materiał: aluminium
Material: Aluminium
matériel: aluminium

raw aluminium
surowe aluminium
Rohaluminium
aluminium brut
76350000

X³

mounting plate X spring
uchwyt X sprężyna
Halter X Feder
fixation X ressort

GROOVE10 BC/UX → 92
DEEP10 BC/UX → 102
FLAT8 H/UX → 114

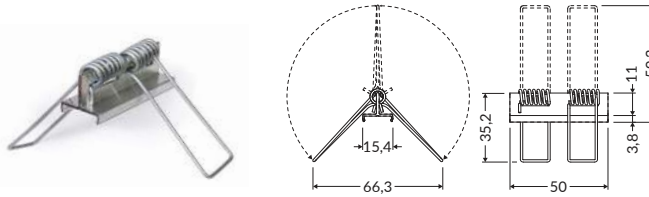

material: aluminium
materiał: aluminium
Material: Aluminium
matériau: aluminium

raw aluminium
surowe aluminium
Rohaluminium
aluminium brut
23130000

Y¹

mounting plate Y
uchwyt Y
Halter Y
fixation Y

SURFACE14 EE7F/TY → 44
SURFACE14.v2 EE7F/Y → 46
LINEA20 EE7F/TY → 50
VARIO30-01 ACDE-9/TY → 59
VARIO30-02 ACDE-9/TY → 60
VARIO30-03 ACDE-9/TY → 63



GROOVE14 EE7F/TY → 96
GROOVE14.v2 EE7F/Y → 98
DIAGONAL14 F/TY → 100
CORNER14 EE7F/TY → 130

material: stainless steel
materiał: stal nierdzewna
Material: rostfreier Stahl
matériau: inox

inox
A2090019

Y²

mounting plate Y cone
uchwyt Y cone
Halter Y cone
fixation Y cone /cône

SURFACE14 EE7F/TY → 44
SURFACE14.v2 EE7F/Y → 46
LINEA20 EE7F/TY → 50
VARIO30-01 ACDE-9/TY → 59
VARIO30-02 ACDE-9/TY → 60
VARIO30-03 ACDE-9/TY → 63



GROOVE14 EE7F/TY → 96
GROOVE14.v2 EE7F/Y → 98
DIAGONAL14 F/TY → 100
CORNER14 EE7F/TY → 130

material: stainless steel
materiał: stal nierdzewna
Material: rostfreier Stahl
matériau: inox

inox
A2130019

Z¹

mounting plate Z
uchwyt Z
Halter Z
fixation Z

SLIM8 AC2/Z → 32
SMART10 AC2/Z → 34
SMART-IN10 AC2/Z → 88



material: stainless steel
materiał: stal nierdzewna
Material: rostfreier Stahl
matériau: acier inoxydable

white		black
biały		czarny
weiß		schwarz
blanc	inox	noir
89270001	89270019	89270002

Z²

mounting plate Z cone
uchwyt Z cone
Halter Z cone
fixation Z cone/cône

SLIM8 AC2/Z → 32
SMART10 AC2/Z → 34
SMART-IN10 AC2/Z → 88



material: stainless steel
materiał: stal nierdzewna
Material: rostfreier Stahl
matériau: inox

white		black
biały		czarny
weiß		schwarz
blanc	inox	noir
89980001	89980019	89980002

LED PROFILE SLINGS ZAWIESIA DO PROFILI LED ABHÄNGUNGEN FÜR LED-PROFILE SUSPENSION POUR PROFILÉS LED

sling SELV
zawiesie SELV
Abhängung SELV
suspension SELV
50 V; 1500



1 kg per 1 set
1 kg na 1 komplet
1 kg für 1 Satz
1 kg par 1 kit

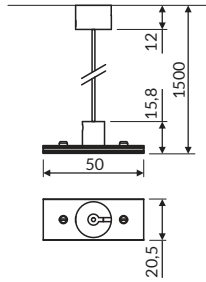

1500 mm	1500 mm	1500 mm
white	silver	black
biały	srebrny	czarny
weiß	silbern	schwarz
blanc	argent	noir
67120001	67120022	67120002

sling for mounting
zawiesie do uchwytu
Abhängung für den Halter
suspension compatibles
avec clips de fixation



10 kg per 1 set
10 kg na 1 komplet
10 kg für 1 Satz
10 kg par 1 kit

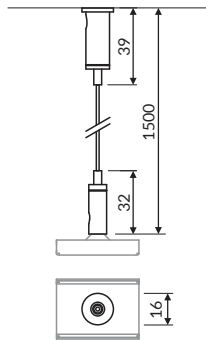

1500 mm
chrome
chrom
Chrom
chrom
67140003

sling large
zawiesie duże
Abhängung groß
suspension grand



10 kg per 1 set
10 kg na 1 komplet
10 kg für 1 Satz
10 kg par 1 kit

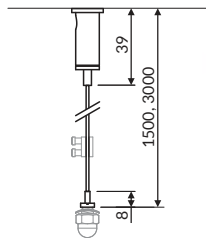

1500 mm	3000 mm
chrome	chrome
chrom	chrom
Chrom	Chrom
chrom	chrom
43100003	43110003

SLINGS ZAWIESIA ABHÄNGUNG SUSPENSION

They enable creating pendant luminaires.
They are especially recommended for
the LED LINEA20, VARIO30-01, VARIO30-02,
COMBO30, PHIL53 profile but are also compatible
with most of the profiles.

Umożliwiają tworzenie opraw wiszących.
Szczególnie polecane są do profilu LED LINEA20,
VARIO30-01, VARIO30-02, COMBO30, PHIL53,
ale kompatybilne są także z większością profili.

Sie ermöglichen den Bau von Hängeleuchten.
Besonders empfohlen sind sie für das LED Profil
LINEA20, VARIO30-01, VARIO30-02, COMBO30,
PHIL53, aber sie sind auch mit der Mehrheit
der Profile kompatibel.

Ils permettent la création de luminaires suspendus.
Ils sont particulièrement recommandés pour le profilé
LED LINEA20, VARIO30-01, VARIO30-02,
COMBO30, PHIL53, mais ils sont également
compatibles avec la plupart des profilés.

MAX
50 V

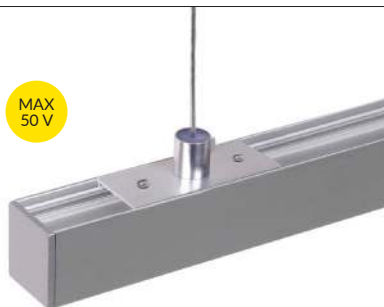

sling SELV 50 V 1500
zawiesie SELV 50 V 1500
Abhängung SELV 50 V 1500
suspension SELV 50 V 1500



sling for mounting
zawiesie do uchwytu
Abhängung für den Halter
suspension compatible
avec clips de fixation



VARIO30 LED ACCESSORIES

AKCESORIA LED DO VARIO30

VARIO30 LED ZUBEHÖR

ACCESSOIRES POUR PROFILÉS LED VARIO30

LED clamp VARIO30
 docisk LED VARIO30
 LED Klemme VARIO30
 clip de fixation LED VARIO30

VARIO30-02 ACDE-9/TY → 60
 VARIO30-03 ACDE-9/TY → 63
 VARIO30-06 ACDE-9/TY → 111
 VARIO30-07 ACDE-9/TY → 112
 VARIO30-04 ACDE-9/TY → 153
 VARIO30-05 ACDE-9/TY → 154

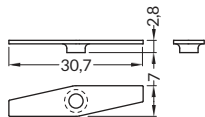

material: steel, plastic
 materiał: stal, tworzywo
 Material: Stahl, Kunststoff
 matériel: acier, plastique

white painted
 biały malowany
 weiß lackiert
 peint en blanc

V4630001

LED clamp VARIO30-1
 docisk LED VARIO30-1
 LED Klemme VARIO30-1
 clip de fixation LED VARIO30 1

VARIO30-02 ACDE-9/TY → 60
 VARIO30-03 ACDE-9/TY → 63
 VARIO30-07 ACDE-9/TY → 112
 VARIO30-05 ACDE-9/TY → 154

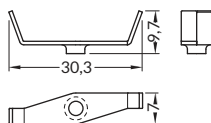

material: steel, plastic
 materiał: stal, tworzywo
 Material: Stahl, Kunststoff
 matériel: acier, plastique

white painted
 biały malowany
 weiß lackiert
 peint en blanc

V4520001

LED mounting VARIO30
 mocowanie LED VARIO30
 LED Montageteil VARIO30
 fixation LED VARIO30

VARIO30-02 ACDE-9/TY → 60
 VARIO30-03 ACDE-9/TY → 63
 VARIO30-07 ACDE-9/TY → 112
 VARIO30-05 ACDE-9/TY → 154

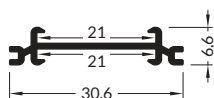

raw aluminium
 surowe aluminium
 Rohaluminium
 aluminium brut

1000 mm	V3570000
2000 mm	V3580000
3000 mm	V3590000
4050 mm	V3600000

OTHER ACCESSORIES POZOSTAŁE AKCESORIA SONSTIGES ZUBEHÖR AUTRES ACCESSOIRES

adhesive tape double-sided
thermally conductive 15 mm x 50 mm
taśma dwustronna
termoprzewodząca 15 mm x 50 m
doppelseitiges
wärmeleitendes Band 15 mm x 50 mm
ruban adhésif double face
thermiqument conducteur 15 mm x 50 m

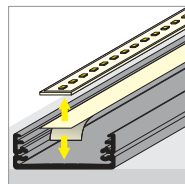

1 reel
1 rolka
1 Rolle
1 rouleau
67990000

adhesive tape double-sided
nonconductive 25 x 25 mm
taśma dwustronna
nieprzewodząca 25 x 25 mm
nicht leitendes
doppelseitiges Band 25 x 25 mm
ruban adhésif double face
non-conducteur 25 x 25 mm

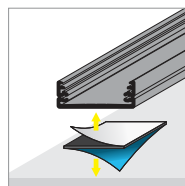
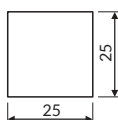

76340000

adhesive tape double-sided mounting
HPX 12mm x 5m
taśma dwustronna montażowa
HPX 12 mm x 5 m
doppelseitiges Montageband
HPX 12 mm x 5 m
ruban adhésif double face
HPX 12 mm x 5 m

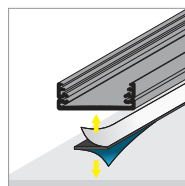

67960000

magnetic holder
M02 6 x 20 x 2 mm
uchwyt magnetyczny
M02 6 x 20 x 2 mm
Magnethalter
M02 6 x 20 x 2 mm
clip de fixation magnétique
M02 6 x 20 x 2 mm

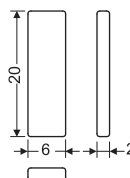

67260000

magnetic holder
M01 10 x 14 x 1,5 mm
uchwyt magnetyczny
M01 10 x 14 x 1,5 mm
Magnethalter
M01 10 x 14 x 1,5 mm
clip de fixation magnétique
M01 10 x 14 x 1,5 mm

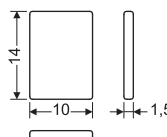

67250000

cleaning rubber
for anodized surfaces
gumka do czyszczenia
powierzchni anodowanych
Radiergummi für die Reinigung
eloxierter Oberflächen
gomme pour le nettoyage
des surfaces anodisées



25250000

SALES SUPPORT WSPARCIE SPRZEDAŻY VERTRIEBSUNTERSTÜTZUNG LE SOUTIEN AUX VENTES

TOPMET Light's e-showroom.
Wirtualny showroom TOPMET Light.
Virtueller TOPMET Light Raum.
Showroom virtuel TOPMET Light.



Get inspired by new products in TOPMET Light's e-showroom.
Zainspiruj się nowymi produktami w wirtualnym salonie TOPMET Light.
Lassen Sie sich von neuen Produkten im virtuellen Raum von TOPMET Light inspirieren.
Laissez-vous inspirer par les nouveaux produits dans le showroom virtuelle TOPMET Light

TOPMET Light's 360° Virtual Showroom
Wirtualny Showroom 360° TOPMET Light znajdziesz tu
ier finden Sie den 360° virtuellen Raum von TOPMET
Vous trouverez ici le showroom virtuel à 360° de TOPMET



Immerse yourself into TOPMET's website
Zanurz się w przestrzeni strony TOPMET
Tauchen Sie ein in die TOPMET-Website
Découvrez les possibilités offertes par le site TOPMET

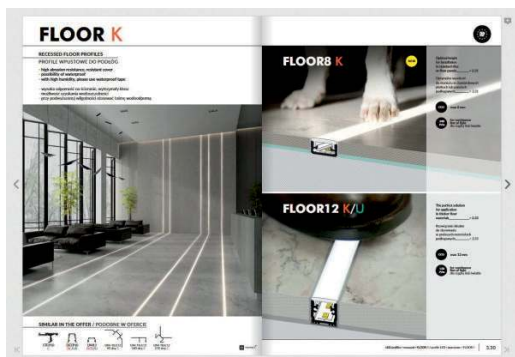

Find all informations about TOPMET's products in our e-catalogue
Znajdź wszystkie informacje o produktach TOPMET
w naszym e-katalogu
Alle Informationen über TOPMET-Produkte finden Sie
in unserem e-Katalog
Retrouvez toutes les informations sur les produits TOPMET



THREE TYPES OF LED PROFILES SAMPLE CASES
TRZY RODZAJE WALIZEK Z PRÓBKAMI PROFILI LED
DREI TYPEN VON KOFFERN MIT LED-PROFILPROBEN
TROIS TYPES DES MALLETTES DE PRESENTATION

FURNITURE	ARCHITECTURAL	LIGHTING
MEBLOWE	ARCHITEKTONICZNE	OŚWIETLENIOWE
MÖBEL-	ARCHITEKTONISCH	BELEUCHTUNGS-
MEUBLES	ARCHITECTURE	ÉCLAIRAGE

ACCESSORIES FOR LED SYSTEM - MOUNTINGS
 SYSTEMOWE AKCESORIA LED - MOCOWANIA
 ZUBEHÖR FÜR LED-SYSTEME - HALTER
 ACCESSOIRES POUR SYSTEMES LED - FIXATIONS

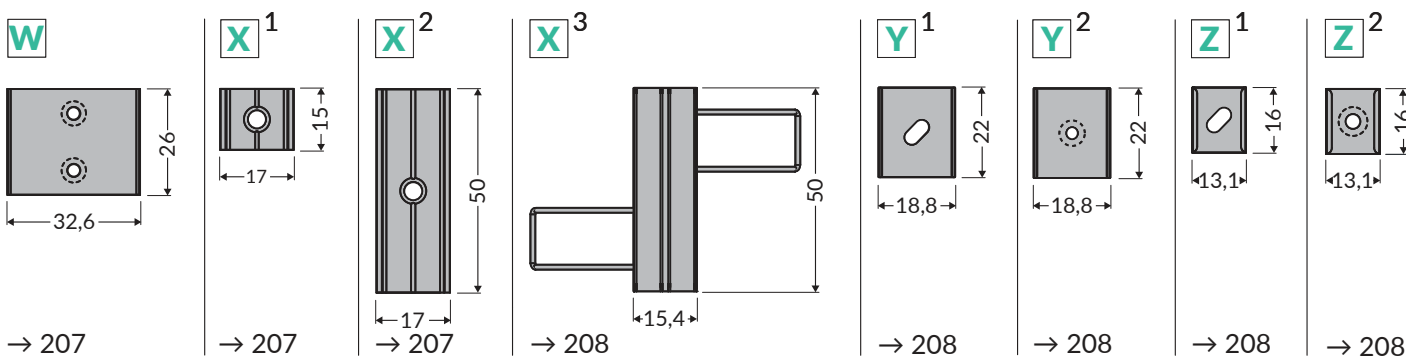
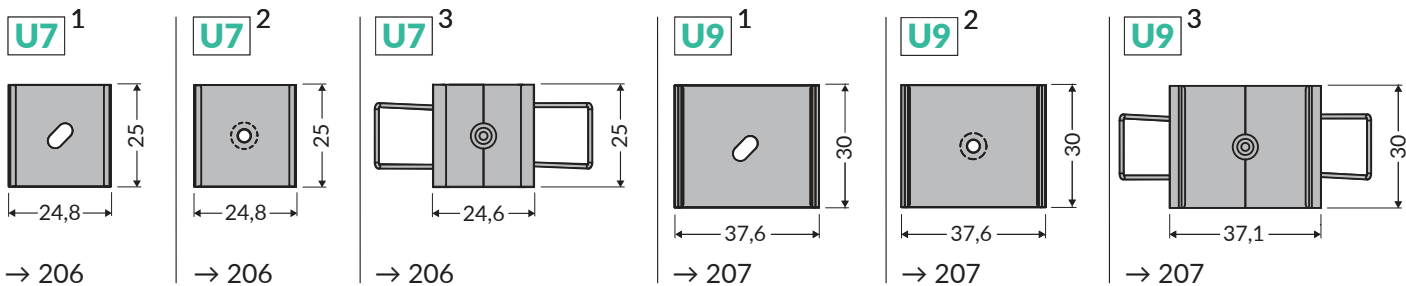
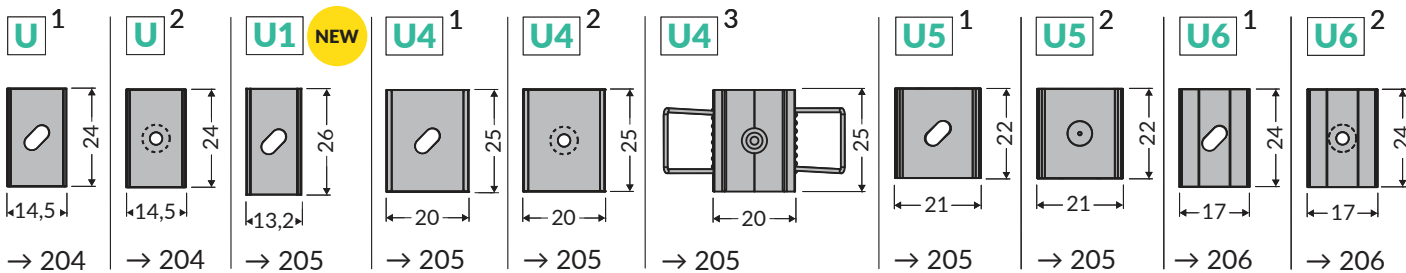
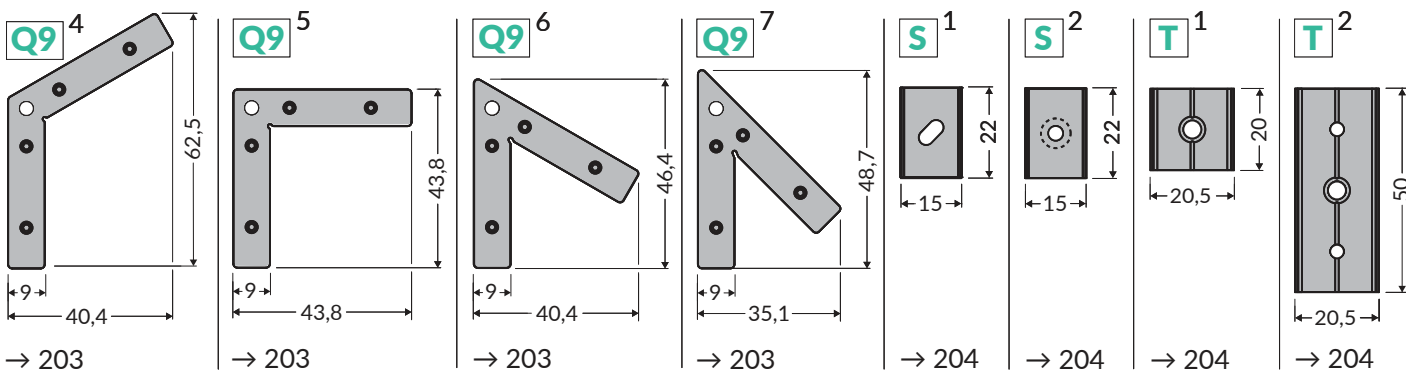
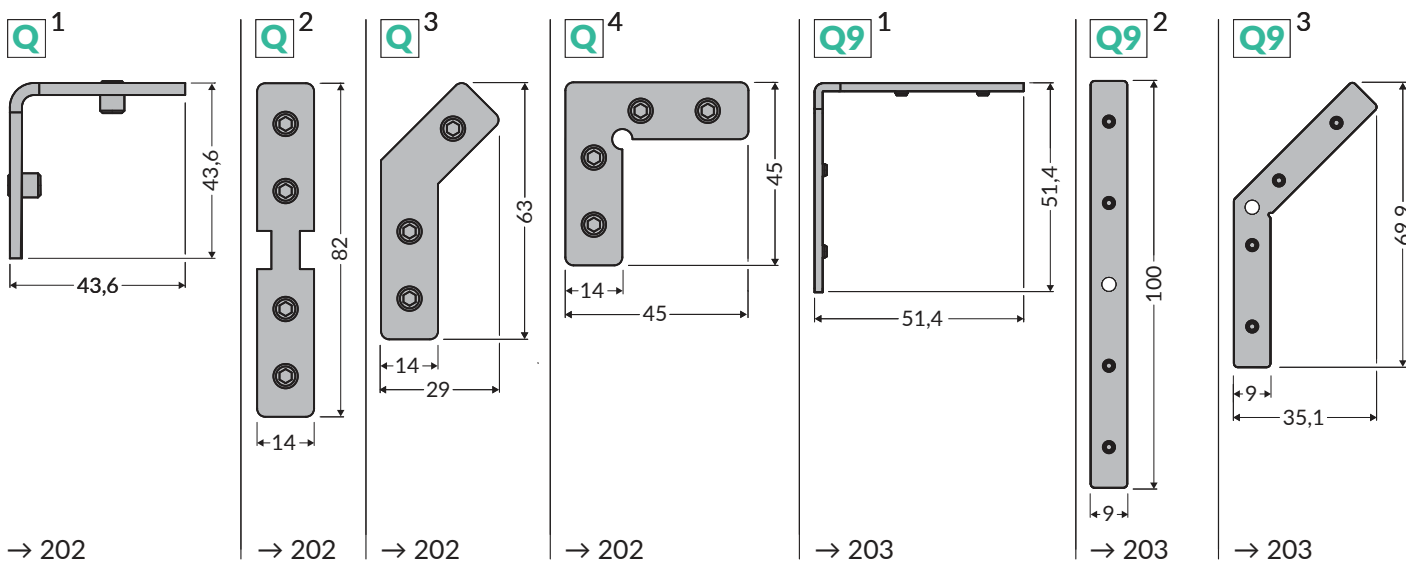



Made in Poland
Wyprodukowane w Polsce
In Polen hergestellt
Fabriqué en Pologne



EU-registered industrial design
Wzory przemysłowe EU
EU Industriemuster
Modèles industriels de l'UE

TOPMET Light Kłósowicz Wiśniewski sp. z o.o.

HEADQUARTERS | SIEDZIBA GŁÓWNA
HAUPTSITZ | SIĘGE SOCIAL
Ostrowska 354
61-312 Poznań, POLAND

FACTORY & WAREHOUSE | PRODUKCJA I MAGAZYN
PRODUKTION UND LAGER | PRODUCTION ET ENTREPOT
Ostrowska 532A
61-324 Poznań, POLAND

RECEPTION OFFICE | SEKRETARIAT
SEKRETARIAT | SEKRÉTARIAT
info@topmet.pl
+48 61 872 75 00
+48 698 610 944

CUSTOMER SERVICE | BIURO OBSŁUGI KLIENTA
KUNDENAUFTRAGSZENTRUM | SERVICE CLIENT
orders@topmet.pl
+48 880 345 292
+48 607 190 334
+48 607 205 107
+48 538 246 716

The catalogue is not an offer under Polish Civil Code regulations. Colours of particular products may vary slightly from colours shown in pictures. The dimensions given are approximate and can not be a reason for complaint. TOPMET Company reserves the right to make technical changes.

Katalog nie stanowi oferty w myśl przepisów Kodeksu Cywilnego. Aktualną ofertę firmy stanowi cennik. Kolory poszczególnych produktów mogą się nieznacznie różnić od kolorów prezentowanych na zdjęciach. Podane wymiary są wymiarami orientacyjnymi i nie mogą stanowić podstawy reklamacji. Firma TOPMET zastrzega sobie prawo do wprowadzania zmian technicznych.

Der Katalog bildet kein Angebot im Sinne der Vorschriften des Zivilgesetzbuches. Das aktuelle Angebot bildet die Preisliste. Die Farben der jeweiligen Produkten können sich leicht von den auf den Bildern dargestellten Farben unterscheiden. Die angegebenen Abmessungen sind nur Orientierungsabmessungen und bilden keine Grundlage für eine Reklamation. Das Unternehmen TOPMET behält sich das Recht zur Einführung von technischen Änderungen vor.

Le catalogue ne constitue pas une offre au sens des dispositions du Code civil. La liste de prix constitue l'offre actuelle de l'entreprise. Les couleurs des produits individuels peuvent légèrement différer des couleurs présentées sur les photos. Les dimensions fournies sont approximatives et ne peuvent constituer la base d'une réclamation. TOPMET se réserve le droit d'apporter des modifications techniques.

catalogue designer • projekt folderu • Katalogdesigner • conception de dossier: M. Kędziora 08.2022.
photo • fotografia • fotografie • photo: A. Szafran, S. Wawrzyn, L. Wesołowski, B. Bieliński.
visualisations • wizualizacje • Visualisierungen • visualisations: M. Kędziora, A. Szafran, P. Woś, B. Bieliński



www.topmet.pl

Distributor / Instrybutor / Distributor / Distributeur



5 901597 258704 >