

KATALOG
hrvatski

PLANA



PLANA



ESENCIJALNO UZ BRIO.

U službi energije, u znaku maksimalne linearnosti: strogost oblika asortimana Plana na prirodan način valorizira svaki prostor, primjenjujući se na inteligentne i intuitivne tehnologije. Uvijek aktualan dizajn, esencijalan i snažne osobnosti koji se otkriva u raznovrsnoj lepezi boja i materijala prilikom svakog uparivanja.

> Oblik: esencijalan, univerzalan, linearan.

Dizajn Plana ističe se geometrijom koja je stroga u kutovima i delikatna u dimenzijama. Rješenja naglašene oblikovne ravnoteže, idealna za ljubitelje minimalističke estetike.

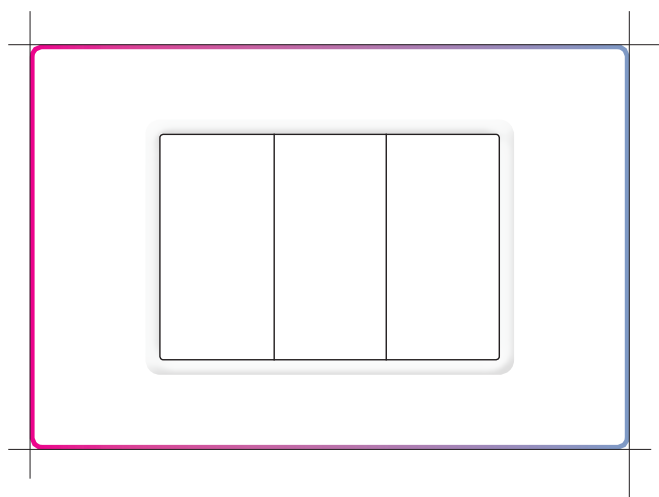

> Harmonija: koordinirana, elegantna, besprijeckorna.

Delikatne u bijeloj boji, elegantne u svjetlucavo srebrnoj, tipke Plana u savršenoj su koordinaciji s bilo kojom teksturom pokrovne maske prilagođavajući se kako svakom instalacijskom zahtjevu tako i raznim ambijentima za primjenu. Maksimum funkcionalnosti uparen s besprijeckornom estetikom.



Bijela Plana

Plana Silver



OTPORNI, FUNKCIONALNI I MODERNI MATERIJALI.

Elegancija metala, toplina drva, modernizam tehнопolimera i svježina sustava Reflex: svaki prostor ima svoj izgled koji Plana zna naglasiti i istaknuti. Prije svega materijalima, koji rasvjetnom mjestu daju odgovarajuću težinu i najprikladniju nijansu. A s bojama, moguće je birati neku od 37 varijanti: od klasične bijele i crne, do boja prirodnog drva javora i kruške, od sjajno zelene i metalno plave do ledenih boja cedra i metvice, jedini problem je izabrati.



> Metal.

Aluminij.

Četkani aluminij za prirodan efekt u koordinaciji s najnovijim tendencijama uređenja prostora.

Metal.

Lakirani metal: materijal koji je elegantan i otporan u isto vrijeme, u šest kromatskih deklinacija s metaliziranim ili sedefastim teksturama.



> Drvo.

Drvo.

Prirodni materijal koji prostorima daje toplinu bez premca. Za sustav Plana sveden je na tri esencije javora, kruške i prirodne trešnje.

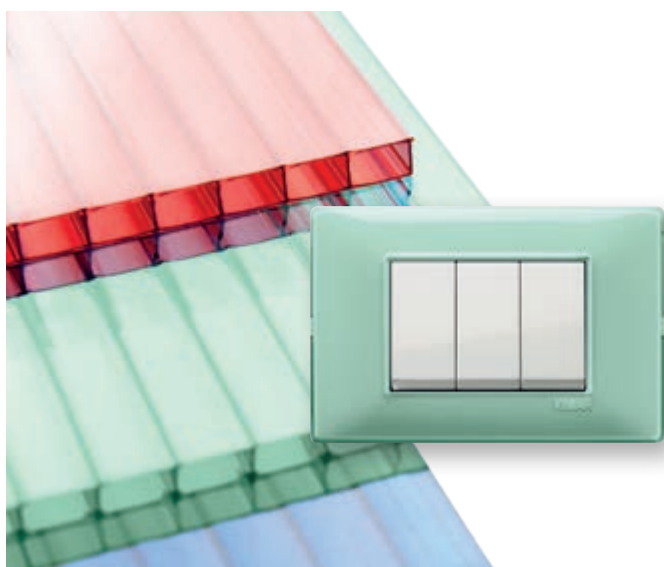

> Reflex.

Reflex.

Svjež moderan i eklektičan, ovaj materijal svojih dvanaest kromatskih varijacija obogaćuje osobitim ledenim efektom. Dvanaest tonaliteta, od najizdašnjih poput narančaste ili smaragdno zelene do najležernijih poput metvice ili zagasito žute.



> Plastika.

Plastika.

Vrhunske značajke esencijalnog izgleda za ovaj materijal koji se artikulira u petnaest kromatskih varijanti, od kojih je jedna i u antibakterijskoj verziji.

PLANA

MNOŠTVO IZNENAĐUJUĆIH BOJA.

Žarke, pastelne, sjajne, glatke, prigušene, metalizirane ili prirodne. Široka i iznenađujuća kromatska raznovrsnost pokrovnih maski Plana zadovoljit će doista svakoga - kako ljubitelje trezvenih boja tako i one kojima su draže žarkije boje - nudeći prirodno okruženje za svačiji ukus.



Metal.



Drvo.

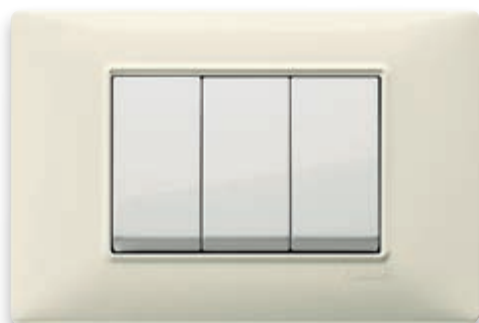

Plastika.



Reflex.



METAL

70 Metalik brončano



71 Metalik srebrno



72 Metalik zeleno



73 Metalik plavo



74 Biserno nikal



75.01 Biserno srebrno



76 Antikni mesing



81 Četkani aluminij

DRVO

61 Javor



62 Kruškino drvo



63 Trešnja

PLASTIKA

01 Bijelo



02 Slonova kost



03 Bež



04 Krema



05 Crno



06 Granit bijelo



20 Matirano srebrno



21 Matirano nikal



22 Matirano šampanj



23 Svjetlacavo smeđe



24 Polirano zlatno



25 Matirano zlatno



31 Jasen



32 Jela



33 Makoré

REFLEX

40 Reflex pepeljastosiva



41 Reflex sniježno-bijela

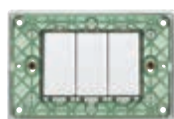

42 Reflex prozirnina



43 Reflex jantarno-žuta



44 Reflex menta-zelena



45 Reflex vodenasto-plava



46 Reflex cedar-žuta



47 Reflex smaragdno-zelena



48 Reflex narančasta



49 Reflex duhan-smeđa



50 Reflex safirno-plava



51 Reflex rubin-crvena



PLANA

KOMANDE.

Plana odgovara na svaki instalacijski i estetski zahtjev brojnim tipovima komandi: nagibnim, domotičkim i komandama s infracrvenim zrakama, radiofrekvencijskim i komandama osjetljivim na dodir. Sve njih odlikuje tehnološka preciznost za koju jamči Vimar. Dostupne su u bijeloj ili srebrnoj boji, komande asortimana Plana omogućavaju maksimalnu slobodu uparivanja s pokrovnim maskama uklapajući se do savršenstva u svaki stil stanovanja.

Dvije varijante boje i tri modularnosti.

Čistoća bjeline i modernizam srebra Silver. Komande s 1, 2 do 3 modula i velikom slobodom personalizacije s laserski urezanim simbolima. Plana odgovara na svaki instalacijski i estetski zahtjev.



Bijele tipke

Silver tipke

> Tradicionalne komande.

U slučaju bilo kakve potrebe za kontrolom energije, Plana nudi komande koje bilo kakav instalacijski i funkcionalni zahtjev zadovoljavaju tehnološkom preciznošću.

Nagibne komande precizne i tihe mehanike koja omogućava savršen dugotrajan rad i ergonomske tipke koje prate i pojednostavljuju geste upravljanja dok pozadinsko osvjetljenje osigurava stalnu i intuitivnu čitljivost pridruženih funkcija.

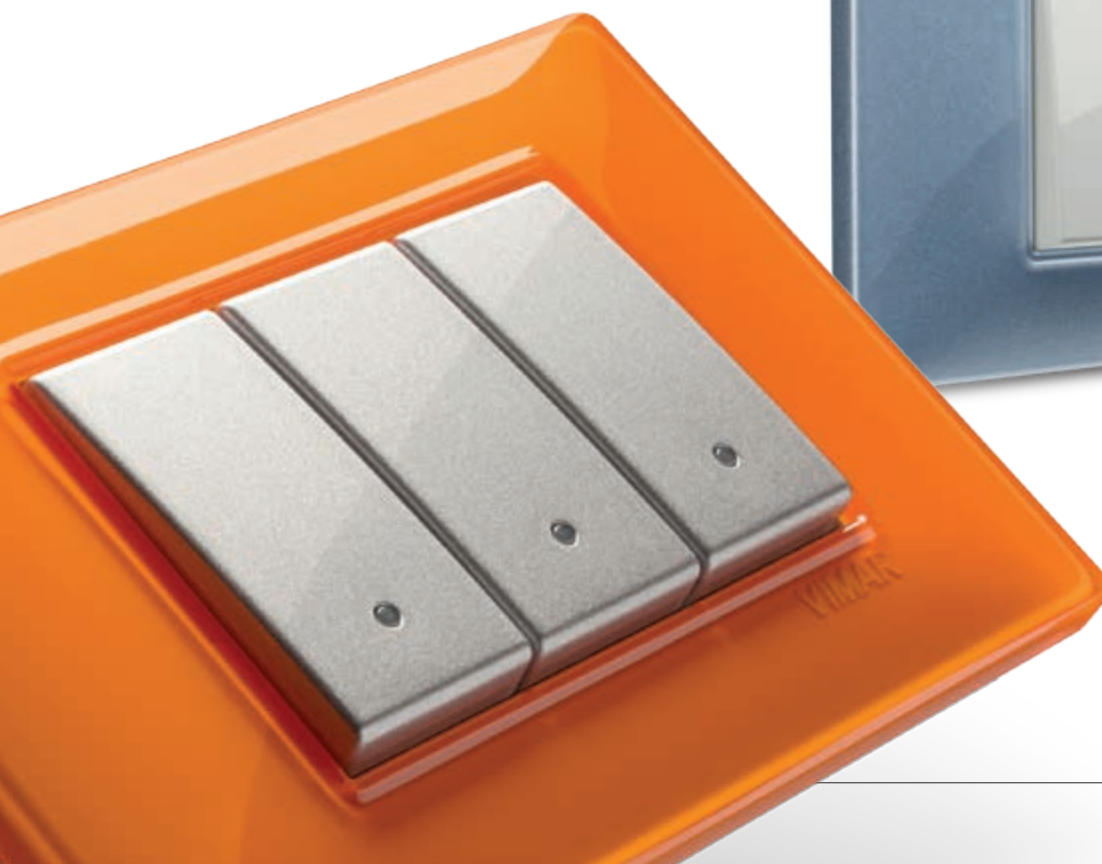

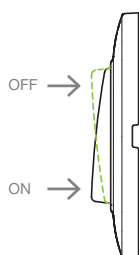

Preklopne komande.

Geometrija s oprugom pomičnog kontakta vrši prirodnu amortizirajuću funkciju, smanjujući električno odbijanje i trošenje, zahvaljujući i velikodušnom povećanju količine srebra u kontaktima.



Pozadinsko LED osvjetljenje.

Pozadinsko osvjetljenje s LED tehnologijom, učinkovito, male potrošnje i dostupno u raznim bojama čini komande vidljivima čak i u mraku, a prikazi simbola urezani laserom ili personalizirani tijekom rada uvijek jasno pokazuju funkcije.

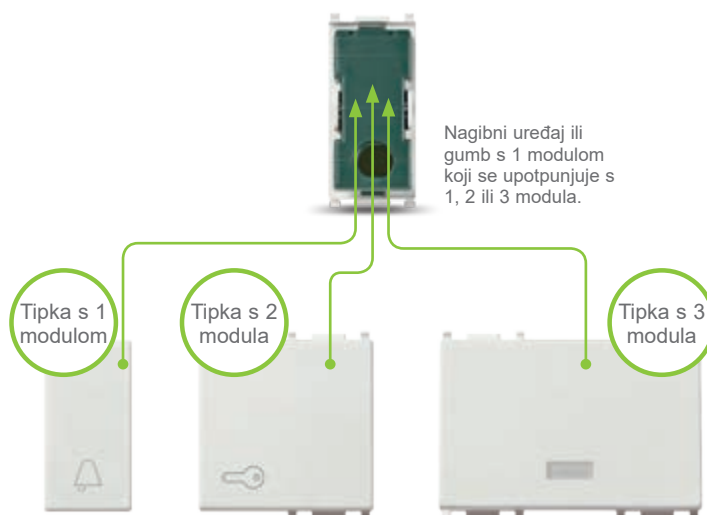

Mehanizam.

Komandni aparat sastoji se od 1 modula s nagibnim načinom rada može biti prekidač, diverter, inverter ili gumb i isporučuje se s neutralnom ili personaliziranom tipkom sa simbolom funkcije.

Mehanizam je moguće upariti s **1 tipkom s 1, 2 ili 3 modula** na temelju rasvjetnog mjesta koje se želi realizirati.



Tehnološko i fluidno svjetlo zelene boje, tipično za komande asortimana Plana dostupno je kao standardna boja pozadinskog osvjetljenja, savršeno se koordinira sa zaslonom elektroničkih uređaja.

PLANA

UREĐAJI ZA KOMANDU I KONTROLU.

Elektroničke i domotičke komande.

Osim tradicionalnim elektromehaničkim komandama, Plana raspolaže uređajima opremljenima naprednim tehnologijama, kao što su domotičke komande koje se mogu integrirati u sustav kućne automatizacije ili automatizacije zgrada radi reguliranja svjetala, roleta, radi upravljanja električnim opterećenjima ili za upravljanje scenarijima i događajima ili kao što su radiofrekvencijske komande kojima ne trebaju električno napajanje ili baterije.

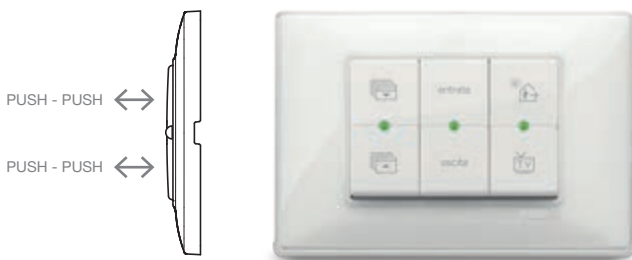

Domotičke komande By-me.

Svjetla, klima i automatizacija aktiviraju se pomoću samo jedne komande čak i u okviru personaliziranih scenarija. Za življenje u domu uz maksimalnu udobnost.

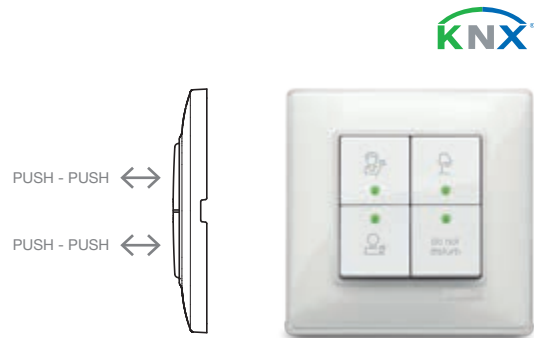

Domotičke komande KNX.

Pomoću 4 neovisna gumba omogućuju lokalno upravljanje scenarijima, svjetlima i automatizacijom. Za neprekidno ostvarivanje maksimalne funkcionalnosti.

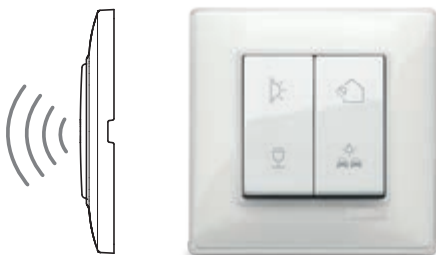

Radiofrekvencijske komande.

Bez električnog napajanja i bez baterija moguće ih je montirati na svaku površinu, čak i na drvo ili staklo. Prijenos signala provodi se putem radija u električni sustav posredstvom aktivatora s protokolima EnOcean, ZigBee Green Power i Bluetooth® wireless technology, bez žičnih spojeva ili zidarskih radova budući da ne postoji potreba za ugradbenim kutijama. Idealne su za restrukturiranja, promjenu namjene ili instalacije koje podliježu arhitektonskim/normativnim ograničenjima.



Komande na infracrvene zrake.

Za upravljanje svjetlima i roletama u potpunoj udobnosti koristeći odgovarajući daljinski upravljač.



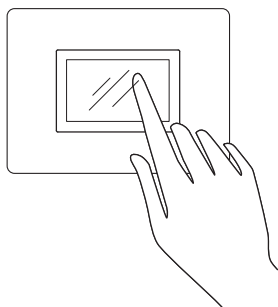

Komande sa zaslonom osjetljivim na dodir.

Dovoljan je jednostavan dodir i cijela kuća odgovara na komande. Ovi elegantni ugradni uređaji omogućuju kontrolu cijelog zdanja ili samo jedne prostorije i opremljeni su jednostavnim i intuitivnim grafičkim sučeljem.



> Posebne komande.

Niz komandi sa specifičnim i posebnim funkcijama koje odgovaraju svakoj potrebi, kako u kući tako i u hotelu.



Posebne komande.

Osim svoje funkcije, zvono je opremljeno s dvije svjetleće žaruljice Do Not Disturb i Please Clean koje izvan sobe priopćavaju zahtjeve klijenta.

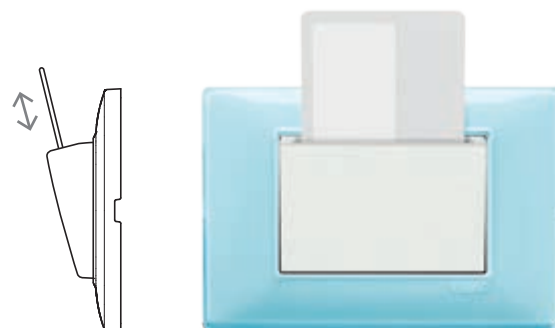

Elektronički čitač s utovorom NFC/RFID.

Razvijen u suradnji s tvrtkama Cisa i AGB, elektronički čitač NFC/RFID transponderskih kartica unutar soba za primjenu u hotelijerstvu kompatibilan je s elektroničkim rješenjima za hotele specijalističkih tvrtki u sustavima za nadzor ulaska na vrata (elektroničke brave).

To je idealno rješenje za tradicionalne i domotičke sustave zahvaljujući povezivanju sa sučeljima sustava By-me i KNX.

UREĐAJI ZA DISTRIBUCIJU ENERGIJE I PODATAKA.

Već godinama Vimar postiže suživot čovjeka i energije u potpunoj sigurnosti. Uz minucioznu brigu posvećenu detaljima, prema visokim standardima kvalitete, sigurnosti i dugotrajnosti. Krajnji rezultat je širok i raznovrstan spektar utičnica za svaki instalacijski zahtjev, od strujnih utičnica pa sve do multimedijских i signalnih.

> Strujne utičnice.

Sve strujne utičnice posjeduju zaštitni zatvarač Sicury (patent Vimar) koji sprječava slučajan kontakt s dijelovima pod naponom. Osim uobičajenih utičnica, dostupnih kako u skladu s talijanskim standardom tako i s onima za glavna inozemna tržišta, ponuda se upotpunjuje utičnicama s blokadom za zaštitu od preopterećenja i USB za brzu nadopunu pametnih telefona, reproduktora mp3 ili tableta, čak i velikih dimenzija.



Utičnice sa zaštitnim zatvaračem SICURY.

B utičnice, univerzalne utičnice i utičnice u bojama za uočljivo razlikovanje namjenskih linija; sve sa zaštitnim zatvaračem Sicury, za napajanje električnih kućanskih aparata ili električnih aparata u rezidencijalnom i tercijarnom okruženju.



Blokirana utičnica.

Prekida električno napajanje kada postoji preopterećenje napona, štiteći ljude.



Utičnice USB.

Omogućuju brzo punjenje sve korištenijih elektroničkih uređaja kao što su pametni telefoni, tableti, reproduktori MP3 i GPS navigatori. Uz to, utičnica High Power velikom brzinom puni najmoćnije uređaje kao što su tableti od 10".



Utičnice u skladu s inozemnim standardima.

Plana nudi široki spektar strujnih utičnica različitih inozemnih standarda kao odgovor na najrazličitije zahtjeve međunarodnog tržišta.

> Signalne i multimedijske utičnice.

Plana nudi mogućnost povezivanja elektroničkih uređaja i prijenosa digitalnog signala putem informatičkih utičnica s tehnološkim rješenjima od bakra i optičkih vlakana, telefonskih utičnica, podatkovnih USB utičnica, utičnica RCA i utičnica TV-RD-SAT; sve one jamče sigurno i brzo povezivanje uz poštovanje visokog standarda kvalitete.



Utičnice TV-RD-SAT.

Jedan jedini uređaj s utičnicama za priključivanje TV prijemnika, radija i satelitskog dekodera.



Multimedijske utičnice.

RCA i HDMI za priključivanje uređaja za kućnu zabavu i USB za podatkovnu mrežu te konektora za spajanje razglasa.



Podatkovne utičnice.

Povezivanje kat. 5 i 6 i 6A za razne vrste kabela UTP i FTP, za mreže od bakra i optičkih vlakana zahvaljujući širokoj ponudi utičnica **Netsafe**, ravnih ili onih pod nagibom od 45 stupnjeva.



Telefonske utičnice.

Višenamjenska rješenja, jednostavna za instalaciju i iznimnih performansi, zahvaljujući asortimanu utičnica **Netsafe**.

UREĐAJI ZA SIGURNOST I ENERGETSKU UČINKOVITOST.

Plana nudi uređaje koji jamče sigurnost ljudi, izbjegavanje oštećenja kućanskih aparata i očuvanje kućnih prostorija. Njima se pridružuju inovativne funkcije koje dozvoljavaju optimiziranje troškova, uz istovremeno zajamčene prednosti i komfor.

Uređaji za sigurnost.

Izvori svjetla visoke učinkovitosti, optimizirani za razna područja korištenja. Automatska modularna svjetla, stubišna rasvjeta, svjetleće žaruljice i prijenosne svjetiljke za nuždu, odmah aktivne u slučaju nestanka električne energije. Svaki uređaj koristi prozirne spekularne difuzore s LED tehnologijom najnovije generacije. Detektori koji signaliziraju i blokiraju gubitke plinova. Protuprovalni sustav By-alarm koji signalizira svaki pokušaj krađe. Videoportafonski uređaji Elvox za realizaciju raznovrsnog i djelotvornog videoportafonskog sustava. Čitači s transponderom na standardnom sustavu KNX za kontrolu ulaza u raznim područjima zgrade.



Svjetlo za slučaj nužde i detektor plina.

Svjetlo za nuždu aktivira se u slučaju nestanka električne energije za sigurno vođenje u mraku. Tehnologija super osjetljiva na istjecanje plina za detektor koji signalizira, blokira i dojavljuje anomaliju.



Protuprovalni sustav By-alarm.

Samostalan i proširiv pomoću širokog spektra uređaja, protuprovalni sustav By-alarm odlikuje se iznimnim performansama i velikom instalacijskom fleksibilnošću. Može upravljati s do 64 zone, instalira se jednostavno putem žičnog ili radiofrekvencijskog priključivanja, a njime se besplatnom aplikacijom By-phone može upravljati i na daljinu putem pametnog telefona i globalnog sustava za mobilne komunikacije (GSM) ili putem fiksne mreže posredstvom pozivanja putem javne telefonske mreže PSTN. Uz to se može integrirati s domotikom By-me.



Videoportafonija Due Fili Plus.

Elegantan zaslon osjetljiv na dodir sa zaslonom od 4,3", s funkcijom videoportafona, funkcionalan i jednostavan za korištenje, ovaj uređaj dozvoljava da se dočekuju gosti i da se uvijek zna tko vam je pred vratima: zaslon prikazuje unutrašnjost kuće, a komande na blagi dodir dozvoljavaju ulazak. Komunicira s ostalim uređajima videoportafonskog asortimana Elvox Videocitofonia.



Kontrola ulaza.

Transponderski čitač usklađen sa sustavom KNX omogućava pristup sobama, određenim područjima ili prostorijama u zgradi samo ovlaštenim osobama.

> Uređaji za energetska učinkovitost.

Maksimalan komfor i ušteda energije: uz sustav Plana, to je moguće postići. Univerzalni regulatori doziraju jačinu LED svjetala i štednih fluorescentnih žarulja (CFL) za stvaranje prave atmosfere. Kronotermostati i satovi za programiranje dozvoljavaju postavljanje, u automatskom ili ručnom načinu rada, idealne temperature i drugih funkcija da bi se izbjegla prekomjerna potrošnja. Funkcija Energy Guard zaslona osjetljivih na dodir Full Flat omogućava praćenje u realnom vremenu troškova cijelog stambenog prostora ili pojedinačnog trošila. Za veću energetska svjesnost.



Univerzalni regulatori i RGB.

Dozvoljavaju reguliranje jačinu svjetla LED svjetala i štednih fluorescentnih žarulja (CFL) i igru s bojama RGB svjetiljki. Na taj način štednja i pravo ozračje sjaje u istom trenutku.



Toplinska regulacija.

Termostati i kronotermostati sa zaslonom osjetljivim na dodir za optimalno upravljanje klimom, s plavim pozadinskim osvjetljenjem koordiniranim s komandama i sondama za očitavanje temperature i vlage.



Senzori pokreta.

Detektori sa senzorom na infracrvene zrake koji omogućuju da se svjetlo upali prilikom prolaska neke osobe nekim prostorom.

SAMOSTALNA RJEŠENJA.

Jednostavna rješenja kojima se na konkretan i jednostavan način odgovara na specifične zahtjeve udobnosti, energetske učinkovitosti i sigurnosti. S poboljšanim funkcijama za tradicionalne električne sustave.

> Kako upravljam energijom i klimom?

Kronotermostati sa zaslonom osjetljivim na dodir koje je moguće programirati putem aplikacije, funkcije centralizirane kontrole putem gumba, energetske nadzor i prikaz vanjske temperature. Spektar sonde temperature i vlage za integraciju u sustave za zagrijavanje tercijarnih objekata.



Uređaji za upotpunjenje sustava.



> Kako ću izraditi podatkovnu mrežu?

Pomoću sustava strukturiranog kablskog snopa Netsafe nudi višenamjenska rješenja, jednostavna za ugradnju i izvrsnih performansi, za mreže od bakra i optičkih vlakana, vrlo velikog djelokruga, a sve je estetski koordinirano putem rješenja Vimar.



Uređaji za upotpunjenje sustava.



> Kako mogu proširiti svoju WLAN mrežu?

Zahvaljujući Wi-Fi pristupnoj točki uz napon od 230 V~, uređaj koji omogućava proširenje WLAN mreže čak i u zonama zgrade koje nisu pokrivene Wi-Fi usmjernikom. Opremljen je prednjim gumbom za uključivanje i isključivanje Wi-Fi signala, stražnjim ulazom za eventualni daljinski gumb i stražnjim konektorom za kablско povezivanje s 2 porta koje je moguće koristiti kao prekidač.



Opcionalni uređaji za upotpunjenje sustava.



> Postoje li komande bez žica?

Bez žica i bez baterija: radiofrekvencijske komande za automatizaciju i upravljanje svjetlima koje je lako instalirati pomoću potpore na drvo, na staklo ili zid, pouzdane su zahvaljujući zelenim tehnologijama EnOcean, ZigBee Green Power i Bluetooth Low Energy koje za napajanje koriste energiju nastalu pritiskanjem tipaka.



Uređaji za upotpunjenje sustava.



Komanda s 4 gumba s radiofrekvencijskim predajnikom, međusobno zamjenjivim tipkama i aktivatorom EnOcean.



Komanda s 4 gumba s radiofrekvencijskim predajnikom i međusobno zamjenjivim tipkama.



Komanda s 4 gumba s radiofrekvencijskim predajnikom i međusobno zamjenjivim tipkama.

> Mogu li kontrolirati Philipsove svjetiljke Friends of Hue?

Zahvaljujući pristupanju programu Friends of Hue, tvrtka Vimar proizvela je radiofrekvencijsku komandu, prema standardu ZigBee Green Power, koja ostvaruje dijalog s mostom Philips Hue. Bez žica i bez energije za napajanje koristi energiju proizvedenu pritiskom na tipke.



Uređaji za upotpunjenje sustava.



Komanda s 4 gumba s radiofrekvencijskim predajnikom i međusobno zamjenjivim tipkama.



> Mogu li slušati glazbu s uređajima Bluetooth?

Zahvaljujući prijammiku Bluetooth ugrađenom u pojačalo od 4+4 W, moguće je iskoristiti Bluetooth tehnologiju vlastitog pametnog telefona za brzo povezivanje s kućnim audio sustavom, a na godišnjem odmoru s onim u vlastitoj hotelskoj sobi.



Uređaji za upotpunjenje sustava.



Stereo pojačalo s ugrađenim prijammikom Bluetooth.

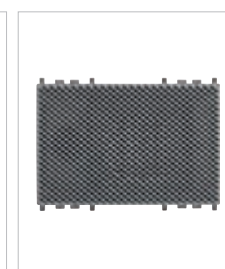

Zvučnici s 3 modula od 3 W i 4+4 modula od 10 W.



➤ Kako na jednostavan način centraliziram svjetla i rolete?

Zahvaljujući unaprijed konfiguriranim uređajima kojima nije potrebno nikakvo specifično programiranje i koji dozvoljavaju realizaciju ili transformaciju klasičnog sustava u mali centralizirani sustav namijenjen upravljanju svjetlima i roletama; idealni za primjene na području stanovanja ili malih tercijarnih djelatnosti, mogu se integrirati u najnapredniji domotički sustav By-me radi proširivanja osnovnih funkcija putem programiranja.



Uređaji za upotpunjenje sustava.



Modul s 9 ulaza i 8 unaprijed programiranih izlaza za rolete i svjetla.

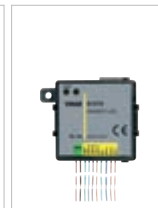

Modul s 3 programabilna digitalna ulaza za rolete i svjetla.



Modul s 2 programabilna digitalna ulaza za rolete.



Modul s 2 programabilna digitalna ulaza za svjetla.



Domotičke komande s 4 gumba (01480), s 4 gumba s aktivatorom (01481) i s 4 gumba s aktivatorom i usmjeravanjem lamela (01482), 2 modula.

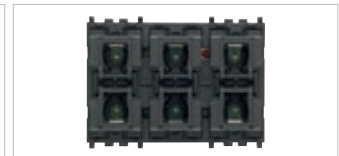

Domotičke komande s 6 gumba (01485), s 6 gumba s aktivatorom (01486) i s 6 gumba s aktivatorom i usmjeravanjem lamela (01487), 3 modula.

➤ Mogu li upravljati roletama primjenom centraliziranog rješenja koje je jednostavno i brzo se ugrađuje?

Komplet za upravljanje roletama omogućava upravljanje s do 5 roleta, tenda ili žaluzina, sa scenarijem potpunog centraliziranog otvaranja ili zatvaranja kojim se može upravljati svakom komandom.

Svi su uređaji unaprijed konfigurirani i potrebno im je samo pravilno ožičenje, nije im potrebno nikakvo konfiguriranje i instalira ih se velikom lakoćom čak i u postojeće sustave.



Uređaji koji sačinjavaju komplet.

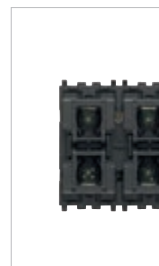

Komandni aparat s 4 gumba.



Komandni aparat za roletu s usmjeravanjem lamela.



Napojna jedinica.

> Kako kontroliram ulaze?

Pomoću elegantnih uređaja koji omogućavaju ulazanje u razne prostorije samo ovlaštenim osobama, jamčeći na taj način punu sigurnost cijeloj strukturi.



Opcionalni uređaji za upotpunjenje sustava.



Čitač/programator pametne kartice.



Čitač za transponderske RFID kartice, kompatibilan s rješenjima za hotele AGB i CISA.

> Kako koordiniram videoportafonski sustav s uređajima Plana?

S video zaslonom osjetljivim na dodir od 4,3" s funkcijom videoportafona, ugradbenim portafonom i pozivnim gumbom koji sjedinjuju napredne radne karakteristike i veliku jednostavnost instalacije i korištenja.



Uređaji za upotpunjenje sustava.



Hands-free portafon.



Tipkalo poziva.

HOME AUTOMATION: ENERGETSKA UČINKOVITOST, SIGURNOST I UDOBNOST RADE ZAJEDNO.

Unutar domotičkog zdanja odvija se potpun i stalan međusobni dijalog raznih funkcija olakšavajući kako velike tako i male svakodnevne radnje čime se jamči veća energetska učinkovitost, sigurnost, udobnost i kontrola.

Mnoštvo rješenja, no sve ih je moguće kontrolirati iz jedne jedine točke. Centralizirano nadgledanje putem elegantnih zaslona osjetljivih na dodir kako bi se optimizirala potrošnja energije, kontroliralo tko vam zvoni na vratima, prilagodila klima i rasvjeta, pomicanje roleta, kako bi se uključio ili deaktivirao protuprovalni sustav, pregledavale snimke telekamera videonadzora ili kako bi se upravljalo širenjem zvuka. Zato što vam želimo omogućiti da u svojem domu živite na najbolji način.

SIGURNOST

UČINKOVITOST

UDOBNOST

NADZOR





Sigurnost.

Jednostavan i učinkovit protuprovalni sustav s vrhunskim radnim karakteristikama. Uređaji za aktiviranje ili isključivanje alarma, senzori za detektiranje ulaska osoba i vanjske signalizacijske jedinice.



Učinkovitost.

Praćenje i prikaz energije u cijeloj zgradi ili one koju troše pojedinačna trošila, učinkovita kontrola temperature radi veće energetske svjesnosti.



Udobnost.

Željena temperatura u cijeloj kući uz mogućnost kontroliranja i programiranja prema svakom pojedinom prostoru. Domotičke komande za pozivanje unaprijed postavljenih scenarija ovisno o vlastitim potrebama.



Nadzor.

Sve funkcije koje se nalaze u stambenom prostoru mogu se kontrolirati centralno iz jednog jedinog komandnog mjesta, lokalno putem pojedinačnih uređaja ili daljinski putem pametnog telefona ili tableta. Za najbolju personalizaciju vlastitog svakodnevnog življenja.



BUILDING AUTOMATION: KONTROLA, UDOBNOŠĆ, ENERGETSKA UČINKOVITOST I SIGURNOST ZGRADA.

Fleksibilan, interoperabilan i integrabilan, Well-contact Plus je sustav tvrtke Vimar, razvijen na standardu KNX, za potpuno upravljanje građevinama. Bilo da se radi o hotelskoj strukturi malih ili velikih dimenzija, ili uredu, nekom polivalentnom centru ili jednostavnoj teretani, Well-contact Plus je rješenje koje omogućava stalan nadzor nad nekretninom. Jedinstveni sustav automatizacije koji putem računala upravlja i svjetlima, temperaturom, sigurnošću, energijom i ulazima nudeći funkcionalnost i udobnost u svakom pojedinom ambijentu u duhu stila i tehnologije made in Italy.

SIGURNOST

UČINKOVITOST

UDOBNOŠĆ

NADZOR

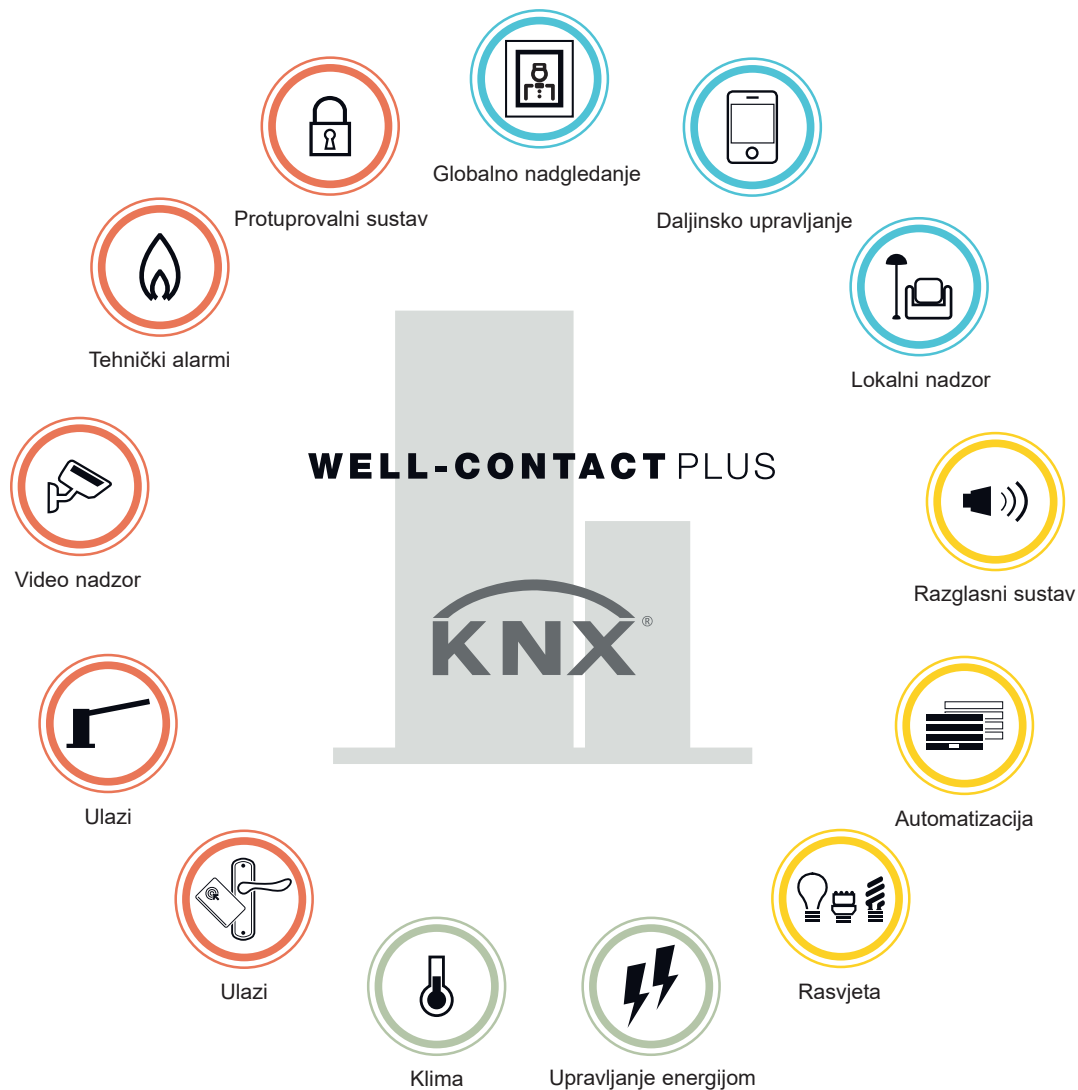



Sigurnost.

Transponderski čitač usklađen sa sustavom KNX omogućava pristup sobama, određenim područjima ili prostorijama u zgradi samo ovlaštenim osobama.



Udobnost.

Klimom u svakom prostoru upravlja se lokalno pomoću elegantnih elektroničkih termostata, opremljenih zaslonom s pozadinskim osvjetljenjem, razvijenih na temelju standarda KNX koje je moguće kontrolirati izravno putem središnjeg računala.



Učinkovitost.

Detektori sa senzorom pokreta s infracrvenim zrakama za paljenje svjetala samo kada je to potrebno.



Nadzor.

Komande KNX s četiri neovisna gumba omogućuju lokalno upravljanje scenarijima, svjetlima i automatizacijom. Tipke raznih dimenzija moguće je međusobno mijenjati, a opremljene su LED diodama za signaliziranje u mraku.

PLANA

RJEŠENJA ZA ZDRAVSTVENE STRUKTURE: TOČNA, SMIRUJUĆA, PRILAGODLJIVA.

Od malih klinika do najsloženijih zdravstvenih struktura, bitno je da uređaji za pozivanje uvijek jamče pravodobnu intervenciju i najpotpuniju skrb. Razvijen kako bi bio usklađen s normom VDE0834-1-2, pozivni sustav Call-way obogaćen je uređajima Plana u verziji **Antibacterial** zbog savršene integracije u te prostore s rješenjima koja pacijentima ulijevaju sigurnost i koja olakšavaju posao zdravstvenom osoblju.



✚ ANTIBACTERIAL

Kako bi se mogla zajamčiti uvijek maksimalna higijena, sustav Plana dostupan je i u antibakterijskoj verziji s pokrovnim maskama, uređajima i terminalima sustava Call-way tretiranim ionima srebra. To je poseban proizvodni postupak koji smanjuje množenje klica i bakterija smanjujući njihovu rasprostranjenost za više od 90% u roku 24 sata.



Pozivni gumb.

Intuitivan uređaj za brzo interveniranje bolničkog osoblja i koji zahvaljujući svjetlećoj žaruljici, pacijentu pruža sigurnost uspješno upućivanja poziva.



Gumb za poništavanje.

Poništava poziv i signalizira prisutnost osoblja u sobi. Zvučni signalizator javlja eventualne pozive koji dolaze iz drugih soba.



Zaslon u hodniku.

Instaliran na raznim odjelima, prikazuje događaje u sustavu poput poziva, dolazaka, kvarova, alarma i odjelnih poruka (čak i reklamnih).



Pozivna tipkovnica sa zaštitom od davljenja.

Ugrađena u svakoj sobi, omogućava da pacijenti upućuju pozive pomoću dvije svjetlosne komande. Proizvedena od antibakterijskog materijala, nudi i funkciju zaštite od davljenja s brzim otkvačivanjem.

PERSONALIZACIJA.

Pokrovne maske Plana mogu se personalizirati vlastitim logotipom uz pomoć korištenja laserske tehnologije koja omogućava reproduciranje visoke razlučivosti neizbrisivo s protokom vremena. Korištenjem iste tehnologije moguće je personalizirati i komande reproduciranjem bilo kojeg simbola na tipkama. Dostupna je i velika arhiva piktoograma koji prikazuju osnovne funkcije kako tradicionalnih tako i domotičkih komandi.

> Personalizacija tipaka.

Radi jasnog prikazivanja funkcije povezane s komandom, na tipke se laserski urezuju simboli odabrani iz našeg arhiva za personalizaciju ili oni koje je dostavio klijent.



Personalizirane tipke s laserskim urezivanjem.



Tipke za domotičke komande KNX personalizacije s laserskim urezivanjem.



Tipke za domotičke komande personalizacije s laserskim urezivanjem.



> Personalizacija pokrovnih maski.

Pokrovne maske Plana mogu se personalizirati vlastitim logotipom. Ovo je rješenje osobito prikladno za tercijarni sektor.

Osim standardnih boja dostupan je i širok spektar tonaliteta boja za dodatno personaliziranje pokrovne maske. Djelatnici naše prodajne službe stoje vam na raspolaganju za detaljno prikazivanje te mogućnosti.



Primjer personalizacije s logotipom tvrtke.

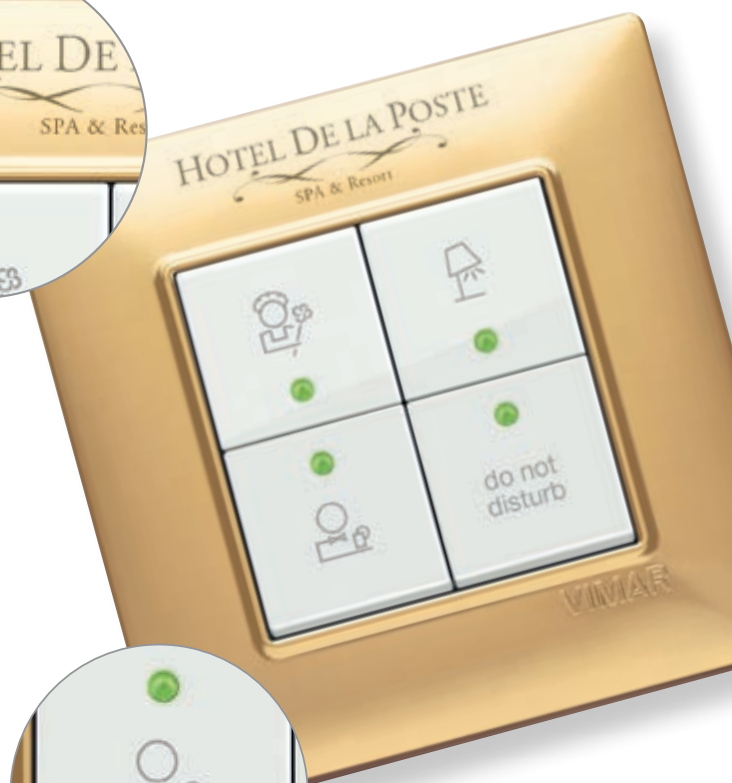

Primjer personalizacije sa simbolima funkcija.



INSTALACIJSKA FLEKSIBILNOST.

Zahvaljujući brojnim dostupnim nosačima koji obuhvaćaju **od 1 pa do maksimalno 21 modula**, **te komanda i utičnicama za 1, 2, 3 ili 4 modula**, moguće je naći rješenja za svaki instalacijski zahtjev. Kako bi se upotpunilo rasvjetno mjesto moguće je odabrati pokrovnu masku omiljenih boja i materijala uz istu modularnost nosača.

Mogućnosti instalacije doista ima mnogo: uređaji se pomoću odgovarajućih kutija mogu instalirati ugradno, na zidove ili na strukture od gips-kartona, ili u nepropusne zidne spremnike za primjene u kojima se traži visok stupanj zaštite, te još i u stolna kućišta kako bi se pristup komandama i utičnicama omogućio izravno na vlastitom radnom mjestu.

> Široka modularnost pokrovnih maski i nosača.

Pokrovne maske i nosači od 1 do 21 modula i uređaji od 1 do 4 modula.



> Modularni uređaji.

Kombinacije s uređajima s 1, 2 i 3 modula na nosaču 3 modula.

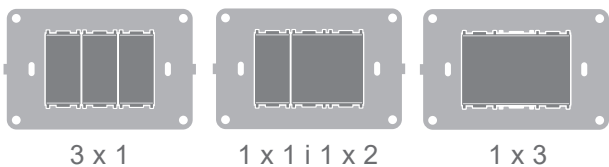

> Ugradne kutije ISOBOX.

Nedeformabilne i otporne za klasične zidove i tanke zidove od gips-kartona.



> Stolno postolje.

S 4, 7 ili 8 modula, za postavljanje rasvjetnog mjesta izravno na radno mjesto. Nagnuto stolno postolje osmišljeno je za ugradnju zaslona osjetljivih na dodir veličine 4,3 inča.

> Središnje upravljačke jedinice.

Dvije kromatske varijante i dizajn osmišljen do najsitnijih detalja za elegantna ugradna rješenja s okomitim razmještajem koja iskorištavaju čak i najskućenije prostore, kako za klasične zidove tako i za one od gips-kartona. Dostupne su i male zidne upravljačke jedinice, kao i široki asortiman dodatne opreme i nosača za vodilicu DIN.

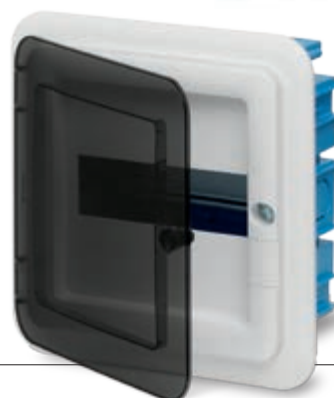

> Zidni spremnici ISOSET.

Spremnici **Isoset sa stupnjem zaštite IP40**, koje je moguće instalirati bilo vodoravno bilo okomito, te **IP55** (standardi EN 60529 CEI 70-1) s vratašcima koja su opremljena membranom za zaštitu od ultraljubičastog zračenja, zajednički oblikovanom ubrizgavanjem u jedan jedini komad zajedno s okvirom.



Spremnici Isoset IP40.

Široki spektar modularnosti omogućava prijam i zaštitu mnoštva uređaja uz pružanje maksimalnog stupnja zaštite čak i u manje zaštićenim prostorijama zgrade poput skladišta, podruma, kotlovnica, mehaničarske radionice.

Spremnik u modularnim sustavima s 2, 4, 6, 8, 10 i 14 modula moguće je instalirati bilo u okomitoj bilo u vodoravnoj bateriji, kako bi se odgovorilo na svaki prostorni zahtjev.



Spremnici Isoset IP55.

Kutije i kupole sa stupnjem zaštite IP55. Prozirna membrana štiti komandu od izravnog doticaja s vodom i prašinom. Poklopac **sa sustavom blokiranja** olakšava i jamči uspjeh operacija zatvaranja i otvaranja. Za sigurno korištenje i u prostorima u kojima postoji opasnost od eksplozije zbog prisutnosti eksploziva, zapaljivih tekućina ili prahova.



INSTALACIJA.

Instalacija je olakšana potporom koja na sebi ima zubiće za uglavljivanje s ciljem čvrstog i sigurnog pričvršćivanja uređaja i savršenog poravnavanja tipaka što ostavlja estetski dojam urednosti i vizualne ljepote. Uređaji se pričvršćuju na frontalnom dijelu nosača, omogućavajući interveniranje u sustav u svakom trenutku bez potrebe za uklanjanjem potpore iz kutije.

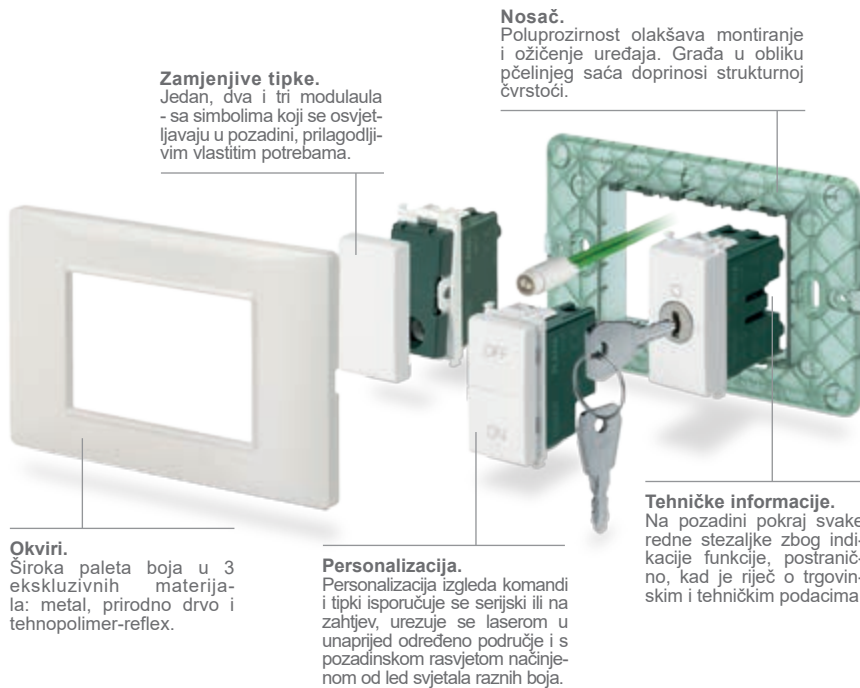

Zamjenjive tipke.

Jedan, dva i tri modulaula - sa simbolima koji se osvjetljavaju u pozadini, prilagodljivim vlastitim potrebama.

Nosač.

Poluprozirnost olakšava montiranje i ožičenje uređaja. Građa u obliku pčelinjeg sača doprinosi strukturnoj čvrstoći.

Tehničke informacije.

Na pozadini pokraj svake sredne stezaljke zbog indikacije funkcije, postranično, kad je riječ o trgovinskim i tehničkim podacima.

Personalizacija.

Personalizacija izgleda komandi i tipki isporučuje se serijski ili na zahtjev, urezuje se laserom u unaprijed određeno područje i s pozadinskom rasvjetom načinjenom od led svjetala raznih boja.

Okviri.

Široka paleta boja u 3 ekskluzivnih materijala: metal, prirodno drvo i tehnopolimer-reflex.

Sustav kvačenja plac-clack®.

Patent tvrtke Vimar koji omogućuje da se na pokrovnu masku prikvače komponente rasvjetnog mjesta (uređaje i potporu) na najlakši i najbrži način.

Kvačenje plac-clack je sustav s utorima koje karakterizira veća strukturna čvrstoća (zahvaljujući strukturi nosača u obliku košnice) i s iznimnom čvrstoćom koja pojednostavljuje frontalno umetanje i skidanje uređaja.

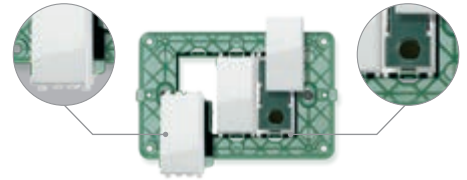

Frontalno pričvršćivanje uređaja na nosač.

Sustav utora za pričvršćivanja uređaja za nosač.



Polaganje kabela s vijčanim stezaljkama.

Svi uređaji Idea koriste tradicionalno polaganje kabela s vijčanim stezaljkama koji se sastoji od stezaljki sa zakrivljenom metalnom pločicom koja će stegnuti kabel uz pomoć vijka s križnom glavom prikladnom za savitljive ili polukrute kabele promjera od 0,5 mm² do 2,5 mm².



Vijčane stezaljke.

Sastoje se od stezaljki sa zakrivljenom metalnom pločicom koja će stegnuti kabel uz pomoć vijka s križnom glavom.



Korištenje kabela raznih promjera.

Polaganje kabela sa savitljivim ili polukrutim kabelom promjera od 0,5 mm² do 2,5 mm².



Tehničke informacije.

Na pozadini pokraj svake redne stezaljke zbog indikacije funkcije, postranično, kad je riječ o trgovinskim i tehničkim podacima.



Ležište namijenjeno signalizacijskoj jedinici.

Ležište namijenjeno signalizacijskoj jedinici, za pozadinsko osvjjetljenje i vidljivost komande čak i u mraku.

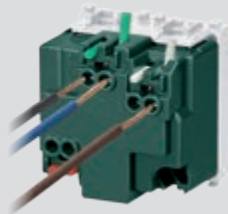

Brzo polaganje kabela Smartfix.

Brzo polaganje kabela Smartfix je patent tvrtke Vimar koji se sastoji od opružnih stezaljki s odvojenim priključcima i bistabilnim malim polugama. Kontaktna ručica omogućuje umetanje i/ili izvlačenje krutih, polukrutih i savitljivih kabela, čak i međusobno različitih veličina, a odvojeni priključci omogućuju neovisno upravljanje svakim pojedinim kabelom, olakšavajući na taj način namjenska održavanja ne ugrožavajući zadržavanje već položenih kabela.



Patent Smartfix.

Patent Smartfix sastoji od opružnih stezaljki od čelika AISI 301, koje karakterizira inovativan geometrijski oblik s odvojenim i nezavisnim priključcima. Ovo rješenje omogućava kako nezavisno upravljanje ulazima kabela tako i polaganjem kabela čiji je promjer i vrsta drukčija u istoj stezaljci, jamčeći u svakom slučaju maksimalno držanje.



Korištenje kabela raznih promjera.

Zahvaljujući opružnim stezaljkama s odvojenim priključcima (patent Smartfix) moguće je polagati kabele raznih promjera čak i istovremeno u dva ulaza u istu stezaljku. U stvari se jamči maksimalno dizanje kako na kabelima promjera 0,5-2,5 mm² za signalne strujne krugove, kao i na kabelima od 1,5-2,5 mm² za strujne krugove snage.



Bistabilne poluge stezaljke.

Na svakom ulazu kabela djeluje bistabilna mala poluga, ako se podigne, otvara kontakt na oprugu omogućujući umetanje polukrutih i savitljivih kabela ili izvlačenje već umetnutih kabela. Djelujući na pojedine kabelske ulaze, poluge olakšavaju aktivnosti održavanja ne ugrožavajući zadržavanje već položenih kabela.



Neovisno upravljanje ulazom kabela.

Opruga s odvojenim priključcima omogućuje da se na nezavisan način upravlja s dva kabelska ulaza iste stezaljke, putem polaganja ili izvlačenja kabela različite vrste i promjera iz jednog ulaza, ne ugrožavajući zadržavanje onih koji su već umetnuti u drugi.

Sastav	Prilog	Okvir	Modula	Ploče
<p>Za panelnu montažu</p>	<p>Za panelnu montažu</p>	<p>s vijcima</p>	<p>1 modul</p>	<p>1 modul*</p>
<p>3 modula</p>	<p>Podžbukna montaža od 3 do 7 modula</p> <p>Nadžbukna montaža</p>	<p>s vijcima</p>	<p>1 i 2 modula</p> <p>3 x 1 modula</p> <p>1 x 3 modula</p>	<p>Od 3 do 7 modula*</p>
<p>8 modula</p>	<p>Podžbukna montaža 4 + 4 modula</p>	<p>s vijcima</p>	<p>Zaslon osjetljiv na dodir veličine 4,3" Full Flat</p> <p>2 x 1 modul i 1 x 2 modula</p> <p>4 x 1 modul</p>	<p>8 modula*</p>

U skladu s njemačkim i francuskim standardima (instalacija s međuosnim razmakom od 71 mm)

<p>2 + 2 modula</p>		<p>71 bez vijcima razmak između centara 71 mm</p> <p>71 bez vijcima razmak između centara 71 mm</p>	<p>2 x 2 modula</p> <p>2 x 2 modula</p>	<p>2 + 2 modula okomita ugradnja*</p> <p>2 + 2 modula vodoravna ugradnja*</p>
---------------------	--	---	---	---

Britanskom standardu

<p>Aparat u jednom komadu</p>	<p>75 75</p>	<p>3 modula s vijcima</p>	<p>Strujna utičnica, aparat u jednom komadu</p> <p>Jedinica ON/OFF aparat u jednom komadu</p> <p>1 i 2 modula</p>	<p>U jednom komadu, vodoravna ugradnja*</p> <p>U jednom komadu, okomita ugradnja*</p> <p>3 modula*</p>
-------------------------------	------------------	---------------------------	---	--

Stolnu montažu

<p>Stolnu montažu</p>	<p>Kutije za stolnu montažu</p>	<p>s vijcima</p>	<p>2 x 1 modul i 1 x 2 modula</p>	<p>Od 4 do 7 modula*</p>
-----------------------	---------------------------------	------------------	-----------------------------------	--------------------------

Opće karakteristike

Instalacija s 3 modula

Zamjenjive tipke

Jedan, dva i tri modulaula - sa simbolima koji se osvjetljavaju u pozadini, prilagodljivim vlastitim potrebama.

Tehničke informacije

Na pozadini pokraj svake redne stezaljke zbog indikacije funkcije, postranično, kad je riječ o trgovinskim i tehničkim podacima.



Okviri

Široka paleta boja u 3 ekskluzivnih materijala: metal, prirodno drvo i tehopolimer-reflex.

Personalizacija

Personalizacija izgleda komandi i tipki isporučuje se serijski ili na zahtjev, urezuje se laserom u unaprijed određeno područje i s pozadinskom rasvjetom načinjenom od led svjetala raznih boja.

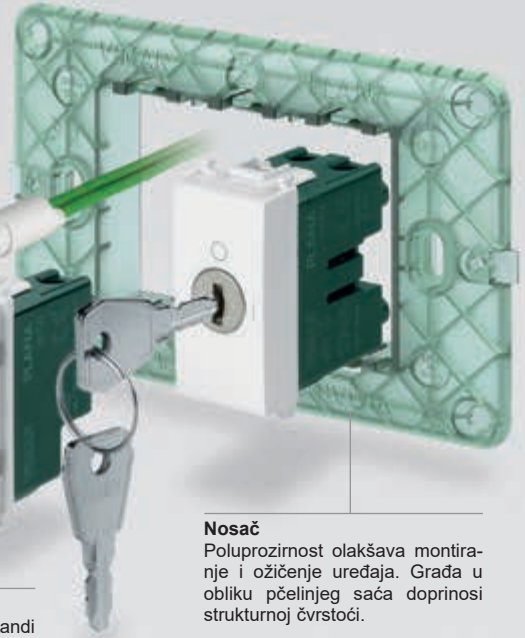

Nosač

Poluprozirnost olakšava montiranje i ožičenje uređaja. Građa u obliku pčelinjeg saća doprinosi strukturnoj čvrstoći.

Sustav prikačivanja Plak-clack®



Prikačivanje uređaja



Otkračivanje uređaja

STEZALJKE ZA BRZO POLAGANJE KABELA

Za krute, polukrute i savitljive kabele. Brzo, jednostavno i sigurno.

Stezaljke za brzo polaganje kabela mogu primiti kruti, polukruti i savitljivi kabel odgovarajući na bilo koji instalacijski zahtjev. U stvari se jamči maksimalno zadržavanje kabela promjera 0,5-2,5 mm² kako za signalne strujne krugove, tako i za kabele od 1,5-2,5 mm² za strujne krugove snage.

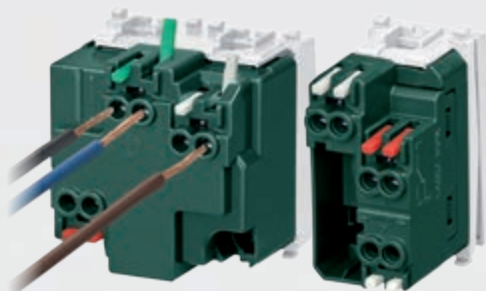







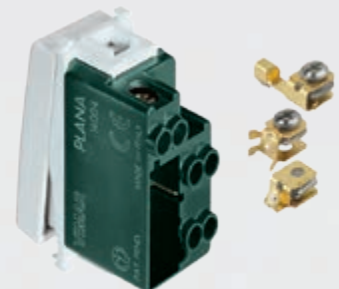

















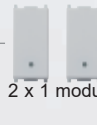











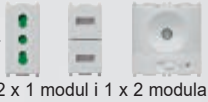

VIJČANE STEZALJKE

Ergonomski kontakti.

Metalna pločica u stezaljkama je zaobljena: to rješenje tvrtke Vimar omogućuje da se kabel zadrži na mjestu sve dok ga se ne stegne vijkom. U stvari se jamči maksimalno zadržavanje kabela promjera 0,5-2,5 mm² kako za signalne strujne krugove, tako i za kabele od 1,5-2,5 mm² za strujne krugove snage.

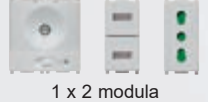
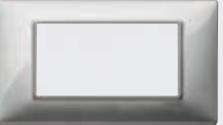

Sastav	Prilog	Okvir	Modula	Ploče
 Za panelnu montažu	 Za panelnu montažu	 s vijcima	 1 modul	 Od 1 do 2 modula Classic ili Round*
 1 ili 2-modulni	 Podžbukna montaža  Nadžbukna montaža	 2 modula s/bez vijcima ili kucicama	 2 modula  2 x 1 modul	 Od 1 do 2 modula Classic ili Round*
 Za 2 središnja modula	 Podžbukna montaža  Nadžbukna montaža	 s vijcima	 2 x 1 modul  2 modula  1 i 2 modula  3 x 1 modul  3 modula	 Za 2 središnja modula Classic ili Round*
 Od 3 do 7 modula	 Nadžbukna montaža	 s vijcima	 3 x 1 modul  3 modula	 Od 3 do 7 modula Classic ili Round*
 8 modula	 Podžbukna montaža	 s vijcima	 Zaslon osjetljiv na dodir veličine 4,3" Energy  2 x 1 modul i 1 x 2 modula  4 x 1 modul	 8 modula Classic ili Round*
 Kutije za stolnu montažu	 Stolnu montažu	 s vijcima	 1 x 2 modula i 2 x 1 modul	 4 i 7 modula Classic ili Round*

* Za ostale kombinacije pogledajte mogućnosti instalacije od str. 96

Opće karakteristike prema britanskom standardu

Ugradnja modularnih aparata

Zamjenjive tipke

Jedan i dva modula - sa simbolima koji se osvijetljavaju u pozadini, prilagodljivim vlastitim potrebama.

Tehničke informacije

Na pozadini pokraj svake redne stezaljke zbog indikacije funkcije, postranično, kad je riječ o trgovinskim i tehničkim podacima.



Nosač

Nosač od nehrđajućeg čelika, s krilcima za brzu i laku ugradnju s prednje strane aparata. Dostupan čak i za ugrađene aparate s 1 modulom s pokrivalom otvora.

Personalizacija

Personalizacija izgleda komandi i tipki isporučuje se serijski ili na zahtjev, urezuje se laserom u unaprijed određeno područje i s pozadinskom rasvjetom načinjenom od LED svjetala raznih boja.

Pokrovna maska

Široka paleta boja, u tehropolimer-reflex.

Aparat u jednom komadu (s ugrađenim nosačem)

Strujni utikači

S patentom SICURY koji služi za izbjegavanje slučajnih kontakata s električnom strujom.

Aparat u jednom komadu
Ugrađenim nosačem.

Pričvrtna krilca

Mogućnost vodoravne i okomite ugradnje aparata.

Signalno LED svjetlo

Signalizacija prisutnog električnog napona, savršeno vidljiva i danju i noću.













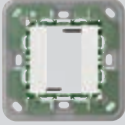











Pokrovna maska

Za vodoravnu i okomitu ugradnju, široka paleta boja, u tehropolimer-Reflex.

Mogućnost sparivanja

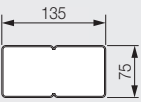

Mogućnost približavanja pokrovnih maski uz minimalan razmak od 25 mm

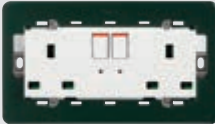
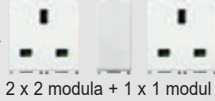
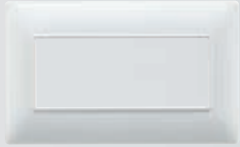
Sastav	Prilog	Okvir	Modula	Ploče
 1 modul, modularna ugradnja	 Ugradna kutija 1 modul. Međuosni razmak: 60,3 mm	 1 modul s vijcima M 3,5	 Prekidač, 1 modul	 1 modul*
 2 modula, modularna ugradnja	 Ugradna kutija 1 modul. Međuosni razmak: 60,3 mm	 2 modula s vijcima M 3,5	 Prekidač sa 3 tipke, 2 modula  2 x 1 modul  1 x 2 modula	 2 modula*
 Aparat u jednom komadu ili modularni aparati	 Ugradna kutija 1 modul. Međuosni razmak: 60,3 mm	 3 modula s vijcima M 3,5	 Strujna utičnica, aparat u jednom komadu  Jedinica ON/OFF aparat u jednom komadu  1 x 2 modula + 1 x 1 modul	 U jednom komadu, vodoravna ugradnja*  U jednom komadu, okomita ugradnja*  3 modula*
 Aparat u jednom komadu ili modularni aparati	 Ugradna kutija 2 modula. Međuosni razmak: 120,6 mm	 5 modula s vijcima M 3,5	 Dvostruka utičnica, aparat u jednom komadu  2 x 2 modula + 1 x 1 modul	 5 modula*

* Za ostale kombinacije pogledajte mogućnosti instalacije od str. 99

Opće karakteristike

Instalacija s \varnothing 60 mm, \varnothing 65x65 mm i s međuosnim razmakom od 71 mm
(u skladu s njemačkim i francuskim standardima)

Zamjenjive tipke

Jedan i dva modula - sa simbolima koji se osvjetljavaju u pozadini, prilagodljivim vlastitim potrebama.

Personalizacija

Personalizacija izgleda komandi i tipki isporučuje se serijski ili na zahtjev, urezuje se laserom u unaprijed određeno područje i s pozadinskom rasvjetom načinjenom od led svjetala raznih boja.

Nosač

Poluprozirnost olakšava montažu i ožičenje uređaja. Građa u obliku pčelinjeg saća doprinosi strukturnoj čvrstoći.











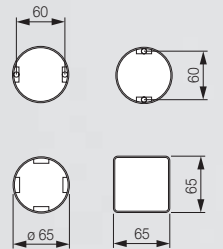
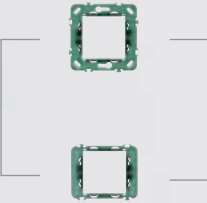



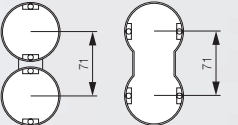
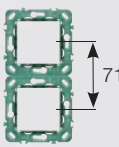
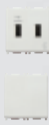

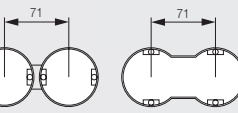
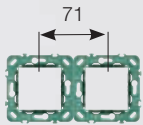
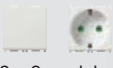

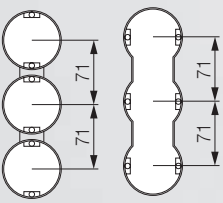
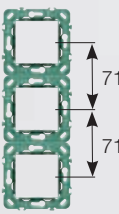
Tehničke informacije

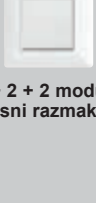
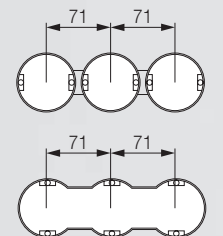
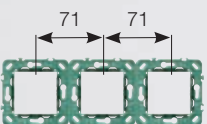
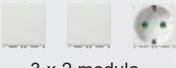
Na pozadini pokraj svake redne stezaljke zbog indikacije funkcije, postranično, kad je riječ o trgovinskim i tehničkim podacima.

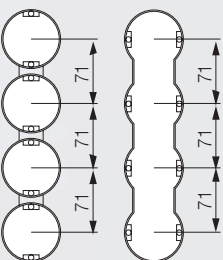
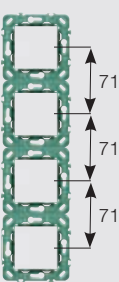
Okviri

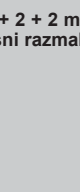
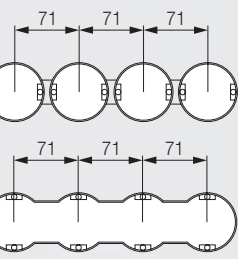
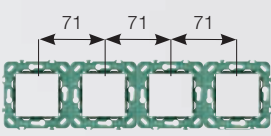
Široka paleta boja, u tehnopolimer-reflex.

Sastav	Prilog	Okvir	Modula	Ploče
 <p>2 modula, ugradne kutije od ø 60 i 65 mm</p>			 <p>1 x 2 modula</p>	 <p>2 modula</p>
 <p>2 + 2 modula, međuosni razmak 71 mm</p>			 <p>2 x 2 modula, okomito</p>	 <p>Okomit smjer</p>
 <p>2 + 2 modula, međuosni razmak 71 mm</p>			 <p>2 x 2 modula, vodoravno</p>	 <p>Vodoravan smjer</p>
 <p>2 + 2 + 2 modula, međuosni razmak 71 mm</p>			 <p>3 x 2 modula, okomito</p>	 <p>Okomit smjer</p>
 <p>2 + 2 + 2 modula, međuosni razmak 71 mm</p>			 <p>3 x 2 modula, vodoravno</p>	 <p>Vodoravan smjer</p>
 <p>2 + 2 + 2 + 2 modula, međuosni razmak 71 mm</p>			 <p>4 x 2 modula, okomito</p>	 <p>Okomit smjer</p>
 <p>2 + 2 + 2 + 2 modula, međuosni razmak 71 mm</p>			 <p>4 x 2 modula, vodoravno</p>	 <p>Vodoravan smjer</p>

* Za ostale kombinacije pogledajte mogućnosti instalacije od str. 100

Opće karakteristike

Instalacija s \varnothing 60 mm, \varnothing 65x65 mm i s međuosnim razmakom od 57 mm
(u skladu sa francuskim standardima)

Nosač

Poluprozirnost olakšava montiranje i ožičenje uređaja. Građa u obliku pčelinjeg saća doprinosi strukturnoj čvrstoći.

Zamjenjive tipke

Jedan i dva modula - sa simbolima koji se osvijetljavaju u pozadini, prilagodljivim vlastitim potrebama.













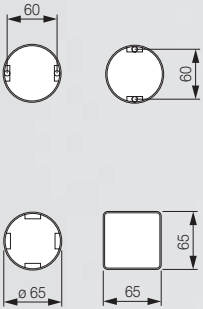
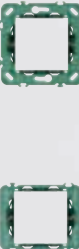

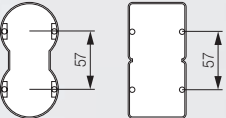
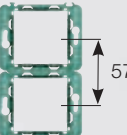

Personalizacija

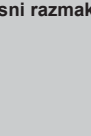
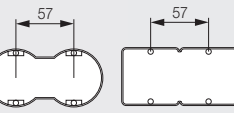
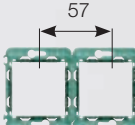
Personalizacija izgleda komandi i tipki isporučuje se serijski ili na zahtjev, urezuje se laserom u unaprijed određeno područje i s pozadinskom rasvjetom načinjenom od led svjetala raznih boja.

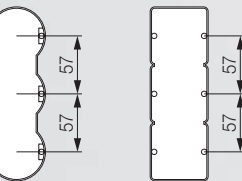
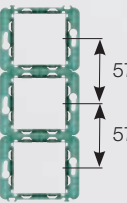

Okviri

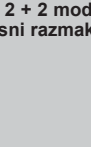
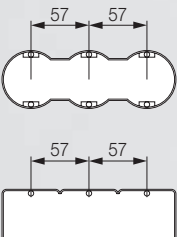
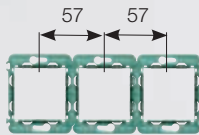
Široka paleta boja u 3 ekskluzivnih materijala: metal, prirodno drvo i tehnopolimer-reflex.

Sastav	Prilog	Okvir	Modula	Ploče
 <p>2 modula, ugradne kutije od ø 60 i 65 mm</p>			 <p>1 x 2 modula</p>	 <p>2 modula</p>
 <p>2 + 2 modula, međuosni razmak 57 mm</p>			 <p>1 x 2 modula 2 x 1 modul, okomito</p>	 <p>Okomit smjer</p>
 <p>2 + 2 modula, međuosni razmak 57 mm</p>			 <p>1 x 2 modula 2 x 1 modul, vodoravno</p>	 <p>Vodoravan smjer</p>
 <p>2 + 2 + 2 modula, međuosni razmak 57 mm</p>			 <p>2 x 2 modula 2 x 1 modul, okomito</p>	 <p>Okomit smjer</p>
 <p>2 + 2 + 2 modula, međuosni razmak 57 mm</p>			 <p>2 x 2 modula 2 x 1 modul, vodoravno</p>	 <p>Vodoravan smjer</p>

* Za ostale kombinacije pogledajte mogućnosti instalacije od str. 100

Plana:

Komandni aparati	od str. 40
Strujne i signalne utičnice	od str. 49
Signalizacija, zaštita i detekcija	od str. 59
Udobnost	od str. 63
Samostalna rješenja	od str. 64
Home automation: By-me 	od str. 70
Building automation: Well-contact Plus 	od str. 81
Bolnički sustav: Call-way	od str. 85
Spektar pokrovnih maski	od str. 88
Vrste instalacije i personalizacije	od str. 96

Spremnici i središnje upravljačke jedinice	od str. 104
--	-------------

Primjeri instalacije	od str. 142
----------------------	-------------

Bijelo
Silver
Slijepi moduli i uvodnice za vodič

14041
Slijepi poklopac
14041.AB
Kao gore, antibakterijske obrade.
Dubina: 10 mm



14042
Slijepi poklopac - 2 modula.
Dubina: 10 mm



14044
Slijepi poklopac s uvodnicom za vodič.
Dubina: 19,5 mm



14041.SL
Slijepi poklopac.
Dubina: 10 mm



14042.SL
Slijepi poklopac - 2 modula.
Dubina: 10 mm



14044.SL
Slijepi poklopac s uvodnicom za vodič.
Dubina: 19,5 mm



14046²
Provodnik kabela 20 A s rednom stezaljkom.
Dubina: 22,1 mm



14047²
Provodnik kabela 45 A s rednom stezaljkom, u jednom komadu.
Dubina: 20 mm



14049³
Priključna jedinica od 13 A s prekidačem i zaštitnim rastalnim osiguračem.
Dubina: 20,4 mm



14046.SL²
Provodnik kabela 20 A s rednom stezaljkom.
Dubina: 22,1 mm



14047.SL²
Provodnik kabela 45 A s rednom stezaljkom, u jednom komadu.
Dubina: 20 mm



14049.SL³
Priključna jedinica od 13 A s prekidačem i zaštitnim rastalnim osiguračem.
Dubina: 20,4 mm

1P 1-obične sklopke 250 V~ (osvjetljiva^o)

14000
10 AX
14001
16 AX
14001.AB
Kao gore, antibakterijske obrade.
Dubina: 24 mm



14000.2
10 AX, - 2 modula
14001.2
16 AX, - 2 modula.
Dubina: 24 mm



14000.SL
10 AX
14001.SL
16 AX.
Dubina: 24 mm



14000.2.SL
10 AX, - 2 modula
14001.2.SL
16 AX, - 2 modula.
Dubina: 24 mm



14002
20 AX.
Dubina: 24 mm



14002.2
20 AX, - 2 modula.
Dubina: 24 mm



14003
Trostruki prekidač 20 AX - 2 modula.
Dubina: 24 mm



14002.SL
20 AX.
Dubina: 24 mm



14002.2.SL
20 AX, - 2 modula.
Dubina: 24 mm



14003.SL
Trostruki prekidač 20 AX - 2 modula.
Dubina: 24 mm

1P 1-obične sklopke 250 V~, stezaljka za brzo polaganje kabela (osvjetljiva^o)

14000.FX
10 AX
14001.FX
16 AX.
Dubina: 25,7 mm



14000.FX.2
10 AX - 2 modula
14001.FX.2
16 AX - 2 modula.
Dubina: 25,7 mm



14000.FX.SL
10 AX
14001.FX.SL
16 AX.
Dubina: 25,7 mm



14000.FX.2.SL
10 AX - 2 modula
14001.FX.2.SL
16 AX - 2 modula.
Dubina: 25,7 mm

Bijelo

Silver

2P 1-obične sklopke 250 V~ (osvjetljiva°)



14015
16 AX
14015.AB
Kao gore,
antibakterijske
obrade.
Dubina:
24 mm

14015.2
16 AX,
- 2 modula.
Dubina: 24 mm



14015.SL
16 AX.
Dubina:
24 mm

14015.2.SL
16 AX,
- 2 modula.
Dubina: 24 mm

2P 1-obične sklopke 250 V~, stezaljka za brzo polaganje kabela (osvjetljiva°)



14015.FX
16 AX.
Dubina:
25,7 mm

14015.FX.2
16 AX
- 2 modula.
Dubina: 25,7 mm



14015.FX.SL
16 AX.
Dubina:
25,7 mm

14015.FX.2.SL
16 AX
- 2 modula.
Dubina: 25,7 mm

2P 1-obične sklopke 250 V~ (osvjetljiva°)



14016
20 AX.
Dubina:
24 mm

14016.2
20 AX, ON/OFF
- 2 modula.
Dubina: 24 mm

14016.WH
20 AX,
Water/Heater.
Dubina: 24 mm

14016.2.WH
20 AX, Water/Heater
- 2 modula.
Dubina: 24 mm



14016.SL
20 AX.
Dubina:
24 mm

14016.2.SL
20 AX, ON/OFF
- 2 modula.
Dubina: 24 mm

14016.WH.SL
20 AX,
Water/Heater.
Dubina: 24 mm

14016.2.WH.SL
20 AX, Water/Heater
- 2 modula.
Dubina: 24 mm



14017
Prekidač 32 A,
ON/OFF.
Dubina: 22,5 mm

14017.WH
Prekidač 32 A,
Water/Heater.
Dubina: 22,5 mm



14017.SL
Prekidač 32 A,
ON/OFF.
Dubina: 22,5 mm

14017.WH.SL
Prekidač 32 A,
Water/Heater.
Dubina: 22,5 mm



14018
Prekidač 45 A,
ON/OFF.
Dubina: 22,5 mm

14018.CK
Prekidač 45 A,
Cooker.
Dubina: 22,5 mm



14018.SL
Prekidač 45 A,
ON/OFF.
Dubina: 22,5 mm

14018.CK.SL
Prekidač 45 A,
Cooker.
Dubina: 22,5 mm

Bijelo
Silver
2P 1-obične sklopke 250 V~ (osvjetljiva°)

14019
Prekidač 45 A,
ON/OFF.
Dubina: 22,5 mm



14019.CK
Prekidač 45 A,
Cooker.
Dubina: 22,5 mm



14019.SL
Prekidač 45 A,
ON/OFF.
Dubina: 22,5 mm



14019.CK.SL
Prekidač 45 A,
Cooker.
Dubina: 22,5 mm

Badge sklopka za karticu (osvjetljiva°)

14466
Badge sklopka za karticu.
Dubina: 27,4 mm



14466.SL
Badge sklopka za karticu.
Dubina: 27,4 mm

1P 2-obične sklopke 250 V~ (osvjetljiva°)

14004
10 AX
14005
16 AX
14005.AB
Kao gore,
antibakterijske
obrade.
Dubina:
24 mm

14004.2
10 AX,
- 2 modula
14005.2
16 AX
- 2 modula.
Dubina:
24 mm



14004.SL
10 AX
14005.SL
16 AX.
Dubina:
24 mm

19004.2.SL
10 AX
- 2 modula
14005.2.SL
16 AX
- 2 modula.
Dubina:
24 mm

1P 2-obične sklopke 250 V~, stezaljka za brzo polaganje kabela (osvjetljiva°)

14004.FX
10 AX
14005.FX
16 AX.
Dubina:
25,7 mm

14004.FX.2
10 AX
- 2 modula
14005.FX.2
16 AX
- 2 modula.
Dubina:
25,7 mm



14004.FX.SL
10 AX
14005.FX.SL
16 AX.
Dubina:
25,7 mm

14004.FX.2.SL
10 AX
- 2 modula
14005.FX.2.SL
16 AX
- 2 modula.
Dubina:
25,7 mm

1P 2-obične sklopke 250 V~ (osvjetljiva°)

14006
20 AX.
Dubina:
24 mm

14006.2
20 AX
- 2 modula.
Dubina: 24 mm



14007
Trostruki prekidač
20 AX - 2 modula.
Dubina: 30,6 mm



14006.SL
20 AX

14006.2.SL
20 AX
- 2 modula.
Dubina: 24 mm



14007.SL
Trostruki prekidač
20 AX - 2 modula.
Dubina: 30,6 mm

Bijelo

Silver

1P osni pretvarači 250 V~ (osvjetljiva°)



14013
16 AX
14013.AB
Kao gore,
antibakterijske
obrade.
Dubina:
24 mm

14013.2
16 AX
- 2 modula.
Dubina:
24 mm



14013.SL
16 AX.
Dubina:
24 mm

14013.2.SL
16 AX
- 2 modula.
Dubina:
24 mm

1P osni pretvarači 250 V~, stezaljka za brzo polaganje kabela (osvjetljiva°)



14013.FX
16 AX.
Dubina:
25,7 mm

14013.FX.2
16 AX
- 2 modula.
Dubina:
25,7 mm



14013.FX.SL
16 AX.
Dubina:
25,7 mm

14013.FX.2.SL
16 AX
- 2 modula.
Dubina:
25,7 mm

1P NO tipkala 250 V~ (osvjetljiva°)



14008
10 A
14008.AB
Kao gore,
antibakterijske
obrade.
Dubina:
24 mm

14008.2
10 A
- 2 modula.
Dubina:
24 mm

14008.2.C
10 A, simbol
zvonca
- 2 modula.
Dubina:
24 mm

14008.2.L
10 A, simbol
svjetla
- 2 modula.
Dubina:
24 mm



14008.SL
10 A.
Dubina:
24 mm

14008.2.SL
10 A
- 2 modula.
Dubina:
24 mm

14008.2.C.SL
10 A, simbol
zvonca
- 2 modula.
Dubina:
24 mm

14008.2.L.SL
10 A, simbol
svjetla
- 2 modula.
Dubina:
24 mm

1P NO tipkala 250 V~, stezaljka za brzo polaganje kabela (osvjetljiva°)



14008.FX
10 A.
Dubina:
25,7 mm

14008.FX.2
10 A
- 2 modula.
Dubina:
25,7 mm



14008.FX.SL
10 A.
Dubina:
25,7 mm

14008.FX.2.SL
10 A
- 2 modula.
Dubina:
25,7 mm

1P NC tipkala 250 V~ (osvjetljiva°)



14010
10 A.
Dubina: 24 mm



14010.SL
10 A.
Dubina: 24 mm

Bijelo

Silver

Mehanizam (osvjetljiva°) - zajednički uređaji za dvije verzije



14000.0
1P 10 AX
obične sklopke.
Dubina: 24 mm



14001.0
1P 16 AX
obične sklopke.
Dubina: 24 mm



14015.0
2P 16 AX
obične sklopke.
Dubina: 24 mm



14004.0
1P 10 AX
izmjenične klopke.
Dubina: 24 mm



14005.0
1P 16 AX
izmjenične klopke.
Dubina: 24 mm



14013.0
1P 16 AX
križne sklopke.
Dubina: 24 mm



14008.0
1P NO 10 A
tipkala.
Dubina: 24 mm



14010.0
1P NC 10 A
tipkala.
Dubina: 24 mm



14002.0
1P 20 AX
obične sklopke.
Dubina: 24 mm



14016.0
2P 20 AX
obične sklopke.
Dubina: 24 mm



14006.0
1P 20 AX
izmjenične sklopke.
Dubina: 24 mm

Mehanizam, stezaljka za brzo polaganje kabela (osvjetljiva°) - zajednički uređaji za dvije verzije



14000.FX.0
1P 10 AX
obične sklopke.
Dubina:
25,7 mm



14001.FX.0
1P 16 AX
obične sklopke.
Dubina:
25,7 mm



14015.FX.0
2P 16 AX
obične sklopke.
Dubina:
25,7 mm



14004.FX.0
1P 10 AX
izmjenične
sklopke.
Dubina:
25,7 mm



14005.FX.0
1P 16 AX
izmjenične
sklopke.
Dubina:
25,7 mm



14013.FX.0
1P 16 AX
križne sklopke.
Dubina:
25,7 mm



14008.FX.0
1P NO 10 A
tipkala.
Dubina:
25,7 mm

Zamjenjive tipke 1 modul (osvjetljiva°)



14021
Bez simbol



14021.G
Prilagodljivi



14026
S difuzorom



14026.DND
Do Not Disturb,
s difuzorom



14021.SL
Bez simbol



14021.G.SL
Prilagodljivi



14026.SL
S difuzorom



14026.DND.SL
Do Not Disturb,
s difuzorom



14026.PLS
Please Clean,
s difuzorom



14029
S prstenom
i pločicom



14021.C
Simbol
zvonca



14021.L
Simbol
svjetla



14026.PLS.SL
Please Clean,
s difuzorom



14029.SL
S prstenom
i pločicom



14021.C.SL
Simbol
zvonca



14021.L.SL
Simbol
svjetla



14021.P
Simbol
ključa



14021.99
Simbol O I,
za 14015.0



14021.PS
Personalizirana
tipka 'Press'



14021.P.SL
Simbol
ključa



14021.99.SL
Simbol O I,
za 14015.0



14021.PS.SL
Personalizirana
tipka 'Press'

Zamjenjive tipke 2 modul (osvjetljiva°)

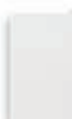

14022
Bez simbol

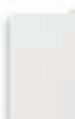

14022.AB
Bez simbol,
antibakterijske
obrade

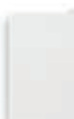

14022.G
Prilagodljivi



14027
S difuzorom



14022.SL
Bez simbol



14022.G.SL
Prilagodljivi



14027.SL
S difuzorom

Bijelo

Silver

Zamjenjive tipke 2 modul (osvjetljiva°)



14022.C
Simbol svjetla

14022.L
Simbol ključa

14022.P
Simbol zvonca

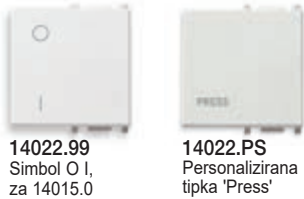

14022.99
Simbol O I,
za 14015.0

14022.PS
Personalizirana
tipka 'Press'

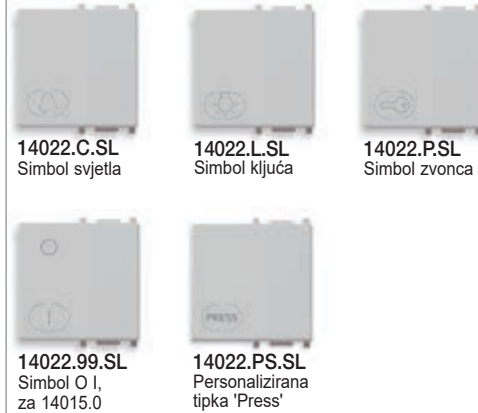

14022.C.SL
Simbol svjetla

14022.L.SL
Simbol ključa

14022.P.SL
Simbol zvonca

14022.99.SL
Simbol O I,
za 14015.0

14022.PS.SL
Personalizirana
tipka 'Press'

Zamjenjive tipke 3 modul (osvjetljiva°)



14023
Bez simbol

14023.G
Prilagodljivi

14028
S difuzorom

14023.C
Simbol zvonca



14023.SL
Bez simbol

14023.G.SL
Prilagodljivi

14028.SL
S difuzorom

14023.C.SL
Simbol zvonca

1P 250 V~ specijalna tipkala



14052
NO 10 A,
potezno.
Dubina:
24 mm

14052.AB
NO 10 A,
potezno,
antibakterijske
obrade.
Dubina:
24 mm

14053
NC 10 A,
potezno.
Dubina:
24 mm

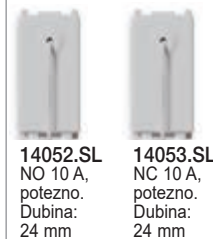

14052.SL
NO 10 A,
potezno.
Dubina:
24 mm

14053.SL
NC 10 A,
potezno.
Dubina:
24 mm



14050
NO 10 A, sa osvjet-
ljivom pločicom
- 2 modula.
Dubina: 24 mm



14097
NO 10 A 230 V~, za hotel "Do Not
Disturb" i svjetleći "Please Clean"
- 2 modula.
Dubina: 27 mm

Dodatna tipkala 1P 250 V~



14056.33
10 A, kontakti
1 NO + 1 NC,
OFF.
Dubina:
28 mm

14056.34
10 A, kontakti
1 NO + 1 NC,
ON.
Dubina:
28 mm

14058
Dva neovisna tipkala
1 NO + 1 NC, 10 A,
simboli ON i OFF.
Dubina: 28 mm

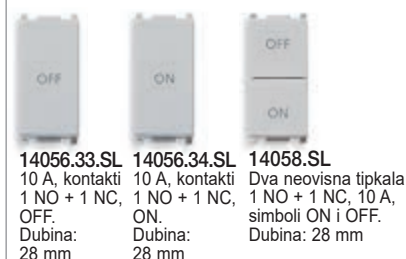

14056.33.SL
10 A, kontakti
1 NO + 1 NC,
OFF.
Dubina:
28 mm

14056.34.SL
10 A, kontakti
1 NO + 1 NC,
ON.
Dubina:
28 mm

14058.SL
Dva neovisna tipkala
1 NO + 1 NC, 10 A,
simboli ON i OFF.
Dubina: 28 mm

Bijelo
Silver
Tipkala 1P 250 V~

14066
Dva neovisna
tipkala NO 10 A.
Dubina: 28 mm



14066.SL
Dva neovisna
tipkala NO 10 A.
Dubina: 28 mm

1P NO 10 A tipkala 250 V~ s indikatorom (za signalne jedinice*)

14068.B
Bijeli
difuzor.
Dubina:
28 mm



14068.B.SL
Bijeli
difuzor.
Dubina:
28 mm

Set/Reset sklopke

14183
Set/Reset sklopka za hitni poziv, 2 NO 5 A
250 V~ relej 12 V~/12-24 Vdc - 2 modula.
Dubina: 36 mm



14183.SL
Set/Reset sklopka za hitni poziv, 2 NO 5 A
250 V~ relej 12 V~/12-24 Vdc - 2 modula.
Dubina: 36 mm

Sklopke 250 V~

14060
Dvo-tipkalna
2P 10 AX,
s OFF
položajem.
Dubina:
32,5 mm



14062
Dva međusobno
neovisna
tipkala
1P NO 10 A.
Dubina:
28 mm



14060.SL
Dvo-tipkalna
2P 10 AX,
s OFF
položajem.
Dubina:
32,5 mm



14062.SL
Dva međusobno
neovisna
tipkala
1P NO 10 A.
Dubina:
28 mm

Sklopke s ključem 2P 250 V~ (za sklopke s unificiranim ključem 000 dodati .CU na osnovnu šifru)

14083
16 AX.
Dubina:
30,5 mm



14083.S
16 AX obična sklopka,
ključ se može izvaditi
u 'O' (OFF) položaju.
Dubina: 30,5 mm



14087
NO 16 A
tipkalo.
Dubina:
30,5 mm



14083.SL
16 AX.
Dubina:
30,5 mm



14083.S.SL
16 AX obična sklopka,
ključ se može izvaditi
u 'O' (OFF) položaju.
Dubina: 30,5 mm



14087.SL
NO 16 A
tipkalo.
Dubina:
30,5 mm

Bijelo

Silver

Regulatori**



14135.1
MASTER,
univerzalna
14135.1.120
Kao gore,
120 V~.
Dubina:
40,5 mm



14136.1
MASTER,
univerzalna,
s potenciometrom.
Dubina:
40,5 mm



14136.AB.1
MASTER,
univerzalna,
s potenciometrom,
antibakterijske
obrade.
Dubina:
40,5 mm



14138
RGB, s
potenciometrom
14138.120
Kao gore,
120 V~.
Dubina:
40,5 mm



14135.1.SL
MASTER,
univerzalna
14135.1.120.SL
Kao gore,
120 V~.
Dubina:
40,5 mm



14136.1.SL
MASTER,
univerzalna,
s potenciometrom.
Dubina:
40,5 mm



14138.SL
RGB, s
potenciometrom
14138.120.SL
Kao gore,
120 V~.
Dubina:
40,5 mm



14139
FADING-SHOW,
s potenciometrom
14139.120
Kao gore,
120 V~.
Dubina:
40,5 mm



14150
100-500 W, s
potenciometrom,
230 V~.
Dubina:
39 mm



14153
100-500 W
push-push +
s potenciome-
trom, 230 V~.
Dubina:
39 mm



***14146**
60-900 W
60-300 VA,
s potenciome-
trom 230 V~.
Dubina:
39 mm



14139.SL
FADING-SHOW,
s potenciometrom
14139.120.SL
Kao gore,
120 V~.
Dubina:
40,5 mm



14150.SL
100-500 W, s
potenciometrom,
230 V~.
Dubina:
39 mm



14153.SL
100-500 W
push-push +
s potenciome-
trom, 230 V~.
Dubina:
39 mm



***14146.SL**
60-900 W
60-300 VA,
s potenciome-
trom 230 V~.
Dubina:
39 mm



14147
30-500 W
30-300 VA,
s potenciome-
trom, 120 V~.
Dubina:
39 mm



***14148**
MASTER,
800 W/500 VA,
120-230 V~.
Dubina:
40,5 mm



14165
MASTER, 500 W
230 V~ - 2 modula.
Za inkandescentne svje-
tijke (sa žarnom niti) i
transformatore s feroma-
gnetskom jezgrom.
Dubina: 32,5 mm



14147.SL
30-500 W
30-300 VA,
s potenciome-
trom, 120 V~.
Dubina:
39 mm



***14148.SL**
MASTER,
800 W/500 VA,
120-230 V~.
Dubina:
40,5 mm



14165.SL
MASTER, 500 W
230 V~ - 2 modula.
Za inkandescentne svje-
tijke (sa žarnom niti) i
transformatore s feroma-
gnetskom jezgrom.
Dubina: 32,5 mm

Regulatori - upravljiva trošila

Vrsta REGULATORI TROŠILA	UNIVERZALNI							
	14135.1				14136.1 - 14136.AB.1			
	Priključak s 2 žice		Priključak s 3 žice		Priključak s 2 žice		Priključak s 3 žice	
	LE	TE	LE	TE	LE	TE	LE	TE
Sa žarnom niti	40 + 400 W	40 + 300 W	40 + 400 W	40 + 300 W	40 + 400 W	40 + 300 W	40 + 400 W	40 + 300 W
Fluorescentne kompaktne (LFC)	10 + 100 W maks. 5 svjet.	10 + 200 W maks. 10 svjet.	10 + 100 W maks. 5 svjet.	10 + 200 W maks. 10 svjet.	10 + 100 W maks. 5 svjet.	10 + 200 W maks. 10 svjet.	10 + 100 W maks. 5 svjet.	10 + 200 W maks. 10 svjet.
LED	5 + 100 W maks. 10 svjet.	5 + 200 W maks. 20 svjet.	3 + 100 W maks. 10 svjet.	3 + 200 W maks. 20 svjet.	5 + 100 W maks. 10 svjet.	5 + 200 W maks. 20 svjet.	3 + 100 W maks. 10 svjet.	3 + 200 W maks. 20 svjet.
Elektronički transformatori za halogene žarulje	40 + 300 VA maks. 3 transf. tip	40 + 300 VA maks. 5 transf. tip	40 + 300 VA maks. 3 transf. tip	40 + 300 VA maks. 5 transf. tip	40 + 300 VA maks. 3 transf. tip	40 + 300 VA maks. 5 transf. tip	40 + 300 VA maks. 3 transf. tip	40 + 300 VA maks. 5 transf. tip
Jedinice napajanja za LED žarulje (art. 01874, 01875)			maks.10 jedinica napajanja	NE primjenjuje se			maks.10 jedinica napajanja	NE primjenjuje se
Svjetiljke za označavanje gasišta (art. 02662)			maks. 10 svjet.	NE primjenjuje se			maks. 10 svjet.	NE primjenjuje se

Vrsta REGULATORI TROŠILA	RGB		FADING-SHOW	
	14138		14139	
Jedinice napajanja RGB (art. 01876)	maks.10 jedinica napajanja		maks.10 jedinica napajanja	
Žarulje RGB (art. 02663)	maks. 10 žarulja		maks. 10 žarulja	

* Ne koristi se u europskim zemljama
° Signalizacija jedinice i lampe, stranica 87

** O vrstama upravljivog opterećenja pogledajte u listu s uputama

Bijelo

Silver

Regulatori - upravljiva trošila

Vrsta	STANDARDNE			
REGULATORI	14150 (s rotacijskim potencijometrom)	14153 (s diverterom push-push i regulacijom s rotacijskim potencijometrom)	14146 (s rotacijskim potencijometrom)	14165 MASTER
TROŠILA				
Sa žarnom niti	100 - 500 W	100 - 500 W	60 - 900 W	40 - 500 W na 50 Hz 40 - 400 W na 60 Hz
Termomagnetski transformatori				40 - 500 VA na 50 Hz 40 - 400 VA na 60 Hz
Prilagodljivi elektronički transformatori za halogene žarulje pri najnižem naponu			60 - 300 VA 230 V~, 50/60 Hz	

Elektroničko napajanje



01874
230 V~ 50 Hz, za prilagodljive svjetiljke LED od 12-24 Vdc
01874.120
Kao gore, 120 V~



01875
230 V~ 50 Hz, za prilagodljive svjetiljke LED od 350/500/700 mA
01875.120
Kao gore, 120 V~



01876
230 V~ 50 Hz, za prilagodljive svjetiljke LED RGB od 12-24 Vdc
01876.120
Kao gore, 120 V~

IR-prijamnik



14172
IR-prijamnik, NO 6 A 230 V~ 230 V~ relejni izlaz 50/60 Hz.
Dubina: 36 mm



14173
IR-prijamnik, 4 A IR-prijamnik, 4 A relejni izlaz, za rolete - 2 modula.
Dubina: 36 mm



14175
IR-prijamnik, 40-450 W/VA 230 V~.
Dubina: 40,5 mm



14172.SL
IR-prijamnik, NO 6 A 230 V~ 230 V~ relejni izlaz 50/60 Hz.
Dubina: 36 mm



14173.SL
IR-prijamnik, 4 A IR-prijamnik, 4 A relejni izlaz, za rolete - 2 modula.
Dubina: 36 mm



14175.SL
IR-prijamnik, 40-450 W/VA 230 V~.
Dubina: 40,5 mm



01849
IR-daljinski upravljač, 14-kanalni



14181
Svjetlosna, NO 6 A 230 V~ relejni izlaz 50/60 Hz
14181.120
Kao gore, 120 V~.
Dubina: 36 mm



14184
Svjetlosna, 60-300 W, 230 V~ 50/60 Hz.
Dubina: 36 mm



00801
Orijentabilni podložak - 1 modul



14181.SL
Svjetlosna, NO 6 A 230 V~ relejni izlaz 50/60 Hz
14181.120.SL
Kao gore, 120 V~.
Dubina: 36 mm



14184.SL
Svjetlosna, 60-300 W, 230 V~ 50/60 Hz.
Dubina: 36 mm



00801.20
Orijentabilni podložak - 1 modul



00805
Adaptor za podžbuknu montažu za orijentabilne podložke.
Dubina: 36,5 mm



00800
Okvir za nadžbuknu montažu za orijentabilne podložke



00805.20
Adaptor za podžbuknu montažu za orijentabilne podložke.
Dubina: 36,5 mm



00800.20
Okvir za nadžbuknu montažu za orijentabilne podložke

Priključnice

Bijelo

Silver

Priključnice SICURY 2P+E 250 V~ Talijanski standard



14201
10 A,
P11.
Dubina:
25 mm



14203
Bpresa 16 A,
P17/11
14203.AB
Kao gore,
antibakterijske
obrade.
Dubina: 25 mm



14209
16 A, P30
- 2 modula.
Dubina:
28,4 mm



14210
16 A, univerzalna, talijanski
i njemački - 2 modula
14210.AB
Kao gore,
antibakterijske obrade.
Dubina: 25 mm



14201.SL
10 A,
P11.
Dubina:
25 mm



14203.SL
Bpresa 16 A,
P17/11.
Dubina:
25 mm



14209.SL
16 A, P30
- 2 modula.
Dubina:
28,4 mm



14210.SL
16 A, univerzalna,
talijanski i njemački
- 2 modula.
Dubina: 25 mm

Priključnice SICURY 2P+E 250 V~ (za namjensko napajanje)



14203.R
Bpresa 16 A,
P17/11, crvena
14203.AB.R
Kao gore,
antibakterijske
obrade.
Dubina: 25 mm



14209.A
16 A, P30,
narančasta
- 2 modula.
Dubina: 28,4 mm



14209.R
16 A, P30, crvena
- 2 modula.
Dubina: 28,4 mm



14209.V
16 A, P30, zelena
- 2 modula.
Dubina: 28,4 mm



14210.AB.A
16 A, univerzalna,
narančasta,
antibakterijske
obrade - 2 modula.
Dubina: 25 mm



14210.R
16 A, univerzalna,
crvena - 2 modula
14210.AB.R
Kao gore,
antibakterijske
obrade.
Dubina: 25 mm



14210.AB.V
16 A, univerzalna,
zelena, antibakterijske
obrade - 2 modula.
Dubina: 25 mm

Priključnice njemačkom standardu od 250 V~



14208
SICURY 2P+E 16 A,
njemački - 2 modula.
14208.AB
Kao gore,
antibakterijske
obrade.
Dubina: 24,8 mm



14208.C
SICURY 2P+E 16 A,
njemački - 2 modula.
Dubina: 29,6 mm



14208.SL
SICURY 2P+E 16 A,
njemački - 2 modula.
Dubina: 24,8 mm



14208.C.SL
SICURY 2P+E 16 A,
njemački - 2 modula.
Dubina: 29,6 mm

Priključnice njemačkom standardu od 250 V~, stezaljka za brzo polaganje kabela



14208.FX
SICURY 2P+E 16 A,
njemački - 2 modula.
Dubina: 32,5 mm



14208.FX.C
SICURY 2P+E 16 A,
njemački - 2 modula.
Dubina: 29,6 mm



14208.FX.SL
SICURY 2P+E 16 A,
njemački - 2 modula.
Dubina: 32,5 mm



14208.FX.C.SL
SICURY 2P+E 16 A,
njemački - 2 modula.
Dubina: 29,6 mm

Priključnice

Bijelo

Silver

Priključnice francuskom standardu od 250 V~



14212
SICURY 2P+E 16 A,
francuski - 2 modula
14212.AB

Kao gore,
antibakterijske
obrade.
Dubina: 25,4 mm



14212.C
SICURY 2P+E 16 A,
francuski - 2 modula.
Dubina: 26,7 mm



14212.SL
SICURY 2P+E 16 A,
francuski - 2 modula.
Dubina: 25,4 mm



14212.C.SL
SICURY 2P+E 16 A,
francuski - 2 modula.
Dubina: 26,7 mm

Priključnice francuskom standardu od 250 V~, stezaljka za brzo polaganje kabela



14212.FX
SICURY 2P+E 16 A,
francuski - 2 modula.
Dubina: 29,5 mm



14212.FX.C
SICURY 2P+E 16 A,
francuski - 2 modula.
Dubina: 29,9 mm



14212.FX.SL
SICURY 2P+E 16 A,
francuski - 2 modula.
Dubina: 29,5 mm



14212.FX.C.SL
SICURY 2P+E 16 A,
francuski - 2 modula.
Dubina: 29,9 mm

Priključnice engleski standard od 250 V~



14214
SICURY 2P+E 5 A,
engleski - 2 modula.
Dubina: 16,8 mm



14218
SICURY 2P+E 16 A,
engleski - 2 modula.
Dubina: 25,2 mm



14219⁴
2P+E 13 A,
engleski - 2 modula.
Dubina: 17 mm



14220
SICURY 2P+E 13 A,
engleski - 2 modula.
Dubina: 21,4 mm



14214.SL
SICURY 2P+E 5 A,
engleski - 2 modula.
Dubina: 16,8 mm



14218.SL
SICURY 2P+E 16 A,
engleski - 2 modula.
Dubina: 25,2 mm



14219.SL⁴
2P+E 13 A,
engleski - 2 modula.
Dubina: 17 mm



14220.SL
SICURY 2P+E 13 A,
engleski - 2 modula.
Dubina: 21,4 mm

Priključnice švicarskom standardu od 250 V~



14226
2P+E 10 A, švicarski,
tip 13 - 2 modula.
Dubina: 41 mm



14226.SL
2P+E 10 A, švicarski,
tip 13 - 2 modula.
Dubina: 41 mm

Priključnice euroameričkom standardu od 250 V~



14233
SICURY
2P 16 A,
euroamerički
(ø 4,8 mm).
Dubina:
28 mm



14248
SICURY 2P+E 16 A,
euro-američki
- 2 modula.
Dubina: 25,5 mm



14249
2 SICURY 2P+E 16 A,
euro-američki
- 3 modula.
Dubina: 23,5 mm



14233.SL
SICURY
2P 16 A,
euroamerički
(ø 4,8 mm).
Dubina:
28 mm



14248.SL
SICURY 2P+E 16 A,
euro-američki
- 2 modula.
Dubina: 25,5 mm



14249.SL
2 SICURY 2P+E 16 A,
euro-američki
- 3 modula.
Dubina: 23,5 mm

Priključnice

Bijelo

Silver

Priključnice američkom standardu i one za Saudijsku Arabiju od 127 V~



14242
SICURY
2P+E 15 A,
američki i
saudijski

14245
2P+E 15 A,
američki i
saudijski.
Dubina:
26,4 mm



14243
2 x SICURY 2P+E 15 A,
američki i saudijski
- 3 modula

14246
2 x 2P+E 15 A,
američki i saudijski
- 3 modula.
Dubina: 25 mm



14245.SL
2P+E 15 A,
američki i
saudijski

14242.SL
SICURY
2P+E 15 A,
američki i
saudijski.
Dubina:
26,4 mm



14243.SL
2 x SICURY 2P+E 15 A,
američki i saudijski
- 3 modula

14246.SL
2 x 2P+E 15 A,
američki i saudijski
- 3 modula.
Dubina: 25 mm

Priključnice američkom standardu od 127 V~



14247
2P+E 15 A,
Američkom.
Dubina:
26,4 mm



14247.SL
2P+E 15 A,
Američkom.
Dubina:
26,4 mm

Priključnice izraelskom standardu od 250 V~



14240
SICURY 2P+E 16 A,
izraelski - 2 modula.
Dubina: 28,7 mm



14240.SL
SICURY 2P+E 16 A,
izraelski - 2 modula.
Dubina: 28,7 mm

Priključnice argentinski standardu od 250 V~



14250
SICURY
2P+E 10 A,
Argentinski.
Dubina:
26 mm



14253
SICURY 2P+E
20 A, Argentinski
- 2 modula.
Dubina: 27,8 mm



14250.SL
SICURY
2P+E 10 A,
Argentinski.
Dubina:
26 mm



14253.SL
SICURY 2P+E
20 A, Argentinski
- 2 modula.
Dubina: 27,8 mm

Priključnice kineski standardu od 250 V~



14254
SICURY 2P+E
16 A, Kineski
- 2 modula.
Dubina: 27,8 mm



14254.SL
SICURY 2P+E
16 A, Kineski
- 2 modula.
Dubina: 27,8 mm

Priključnice

Bijelo

Silver

Priključnice australijanski standardu od 250 V~



14261
SICURY 2P+E
10 A, Australijanski
- 2 modula.
Dubina: 28,2 mm



14262
SICURY 2P+E
15 A, Australijanski
- 2 modula.
Dubina: 28,2 mm



14261.SL
SICURY 2P+E
10 A, Australijanski
- 2 modula.
Dubina: 28,2 mm



14262.SL
SICURY 2P+E
15 A, Australijanski
- 2 modula.
Dubina: 28,2 mm

Priključnice brazilski standardu od 250 V~



14264
SICURY
2P+E 10 A,
Brazilski.
Dubina:
31,5 mm



14265
SICURY
2P+E 20 A,
Brazilski.
Dubina:
31,5 mm



14264.SL
SICURY
2P+E 10 A,
Brazilski.
Dubina:
31,5 mm



14265.SL
SICURY
2P+E 20 A,
Brazilski.
Dubina:
31,5 mm

Priključnice multi-standardu od 250 V~



***14257**
SICURY 2P+E 13 A,
višestandardne
- 2 modula.
Dubina: 17,7 mm



▲14255
SICURY 2P+E 13 A,
višestandardne
- 3 modula.
Dubina: 18,54 mm



***14257.SL**
SICURY 2P+E 13 A,
višestandardne
- 2 modula.
Dubina: 17,7 mm



▲14255.SL
SICURY 2P+E 13 A,
višestandardne
- 3 modula.
Dubina: 18,54 mm

Utičnice prema britanskom standardu 250 V~ (s uključenom jedinicom za signalizaciju 00930°)



14221⁴
SICURY 2P+E 13 A
+ prekidač 2P.
Dubina: 17,5 mm



14222⁴
2 x SICURY 2P+E 13 A
+ prekidač 2P.
Dubina: 17,5 mm



14221.SL⁴
SICURY 2P+E 13 A
+ prekidač 2P.
Dubina: 17,5 mm

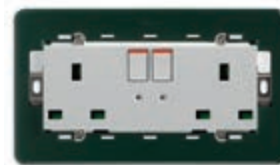

14222.SL⁴
2 x SICURY 2P+E 13 A
+ prekidač 2P.
Dubina: 17,5 mm



14215⁵
SICURY 2P+E 5 A
+ prekidač 2P.
Dubina: 17,5 mm



14217⁵
SICURY 2P+E 15 A
+ prekidač 2P.
Dubina: 25,5 mm



14215.SL⁵
SICURY 2P+E 5 A
+ prekidač 2P.
Dubina: 17,5 mm



14217.SL⁵
SICURY 2P+E 15 A
+ prekidač 2P.
Dubina: 25,5 mm

Priključnice

Bijelo

Silver

Utičnice prema američkom standardu od 2P+E 15 A 60 Hz 125 V~

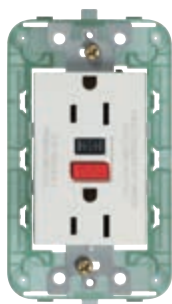

14296
Dvije utičnice prema američkom standardu sa GFCI - 3 modula.
Dubina: 33,4 mm

Moguća uparivanja - standardni inozemni utikači i utičnice

UTIKAČ \ UTIČNICA	Njemački	Francuski	Engleski				Švicarski	Izraelski	Standardni britanski			
	14208...	14212...	14214	14218	14219	14220	14226	14240	14221	14222	14215	14217
Utikač prema talijanskom standardu tipa S10	•	•						•				
Euroutikač 2P 2,5 A	•	•					•	•				
Utikač 2P+T 16 A 250 V~ njemački standard	•							○				
Utikač 2P+T 16 A 250 V~ kombinirani prema njemačkom i francuskom standardu	•	•						○				
Utikač 2P 16 A 250 V~ kombinirani prema njemačkom i francuskom standardu	•	•						•				
Utikač 2P+T 16 A 250 V~ francuski standard		•						○				
Utikač 2P+T 10 A 250 V~ švicarski standard							•					
Utikač 2P+T 16 A 250 V~ izraelski standard								•				
Utikač 2P+T 5 A 250 V~ engleski standard			•								•	
Utikač 2P+T 13 A 250 V~ engleski standard					•	•			•	•		
Utikač 2P+T 16 A 250 V~ engleski standard				•								
Utikač 2P+T 15 A 250 V~ engleski standard												•
Utikač 2P 13 A 220 V~ standard Saudijske Arabije									•	•		

● Standard utikača uparivog s utičnicom; ○ Standard utikača uparivog s utičnicom bez izrade priključka na uzemljenje.

Moguća uparivanja - standardni inozemni utikači i utičnice

UTIKAČ \ UTIČNICA	Argentinski		Brazilski		Kineski	Australski	
	14250	14253	14264	14265	14254	20261	14262
Euroutikač 2P 2,5 A			•	•			
Utikač 2P+T 10 A 250 V~ standard argentiničan	•						
Utikač 2P+T 20 A 250 V~ argentinski standard		•					
Utikač 2P+T 10 A 250 V~ brazilski standard			•	•			
Utikač 2P+T 20 A 250 V~ brazilski standard				•			
Utikač 2P+T 16 A 250 V~ kineski standard					•		
Utikač 2P+T 10 A 250 V~ australški standard						•	
Utikač 2P+T 15 A 250 V~ australški standard							•

● Standard utikača uparivog s utičnicom; ○ Standard utikača uparivog s utičnicom bez izrade priključka na uzemljenje.

Priključnice

Bijelo

Silver

Moguća uparivanja - standardni inozemni utikači i utičnice

UTIKAČ \ UTIČNICA	Multistandardni		Američki		Euroamerički			Američki Saudijska Arabija			
	14257	14255	14247	14296	14233	14248	14249	20242	20245	20243	20246
Utikač prema talijanskom standardu tipa S10	•	•			•	•	•				
Euroutikač 2P 2,5 A	•	•			•	•	•				
Utikač 2P+T 16 A 250 V~ njemački standard	○	○			○	○	○				
Utikač 2P+T 16 A 250 V~ kombinirani prema njemačkom i francuskom standardu					○	○	○				
Utikač 2P 16 A 250 V~ kombinirani prema njemačkom i francuskom standardu					•	•	•				
Utikač 2P+T 16 A 250 V~ francuski standard					○	○	○				
Utikač 2P+T 15 A 125 V~ američki standard				•		•	•				
Utikač 2P+T 15 A 250 V~ američki standard			•								
Utikač 2P+T 10 A 250 V~ švicarski standard	•	•									
Utikač 2P+T 5 A 250 V~ engleski standard	•	•									
Utikač 2P+T 13 A 250 V~ engleski standard	•	•									
Utikač 2P+T 15 A 125 V~ američki standard								•	•	•	•
Utikač 2P 15 A 127 V~ američki standard i standard Saudijske Arabije								•	•	•	•
Utikač 2P+T 10 A 250 V~ brazilski standard	•	•									
Utikač 2P+T 10 A 250 V~ kineski standard	•	•									
Utikač 2P+T 10 A 250 V~ australski standard	•	•									

• Standard utikača uparivog s utičnicom; ○ Standard utikača uparivog s utičnicom bez izrade priključka na uzemljenje.

Priključnice SICURY 2P+E sa strujnom zaštitnom sklopkom RCBO - $I_{\Delta n}$ 10 mA, (120-230 V~ 50/60 Hz)



14273
Bpresa 16 A P17/11
250 V~, 1P+N
C 16 - 2 modula.
Dubina: 38,7 mm



14276
16 A P30 250 V~,
1P+N C 16
- 3 modula.
Dubina: 38,8 mm



14273.SL
Bpresa 16 A P17/11
250 V~, 1P+N
C 16 - 2 modula.
Dubina: 38,7 mm



14276.SL
16 A P30 250 V~,
1P+N C 16
- 3 modula.
Dubina: 38,8 mm



14283
Bpresa 16 A P17/11
250 V~, 1P+N C 16
- 3 modula.
Dubina: 38,7 mm



14286
16 A P30 250 V~,
1P+N C 16
- 4 modula.
Dubina: 38,7 mm



14283.SL
Bpresa 16 A P17/11
250 V~, 1P+N C 16
- 3 modula.
Dubina: 38,7 mm



14286.SL
16 A P30 250 V~,
1P+N C 16
- 4 modula.
Dubina: 38,7 mm

Priključnice • Priključnice za prijam signala

Bijelo

Silver

Priključnica za brijaći aparat



14290
230 V~ 50/60 Hz, s izolacijskim transformatorom 20 VA, 230 V~ i 120 V~ izlaznim naponom - 3 modula

14290.AB

Kao gore, antibakterijske obrade.
Dubina: 41 mm



14291°

230 V~ 50/60 Hz, s izolacijskim transformatorom 20 VA, 230 V~ i 120 V~ izlaznim naponom.
Dubina: 41 mm



14290.SL
230 V~ 50/60 Hz, s izolacijskim transformatorom 20 VA, 230 V~ i 120 V~ izlaznim naponom - 3 modula.
Dubina: 41 mm



14291.SL°

230 V~ 50/60 Hz, s izolacijskim transformatorom 20 VA, 230 V~ i 120 V~ izlaznim naponom.
Dubina: 41 mm

Napajač s izlazom USB



14292
Alimentator 5 V 1,5 A, 1 USB, 120-230 V~ 50/60 Hz.
Dubina: 36 mm



14295
5 V 2,1 A napajač s izlazom, 2 izlaza USB koji sveukupno daju 2,1 A, 120-230 V~ 50/60 Hz - 2 modula.
Dubina: 36 mm



14292.SL
Alimentator 5 V 1,5 A, 1 USB, 120-230 V~ 50/60 Hz.
Dubina: 36 mm



14295.SL
5 V 2,1 A napajač s izlazom, 2 izlaza USB koji sveukupno daju 2,1 A, 120-230 V~ 50/60 Hz - 2 modula.
Dubina: 36 mm

Specijalne priključnice



14330
2P 6 A 24 V (SELV), za utikače 01620

14330.AB
Kao gore, antibakterijske obrade.
Dubina: 24 mm



14331
2P 6 A 24 V (SELV), za utikače 01616/ 01617.

Dubina: 24 mm



14332
2P 6 A 24 V (SELV).
Dubina: 23 mm



14333
5-polna DIN 41524 priključnica.
Dubina: 10 mm



14345
USB, vijčani priključci.
Dubina: 30,9 mm



14330.SL
2P 6 A 24 V (SELV), za utikače 01620.
Dubina: 24 mm



14331.SL
2P 6 A 24 V (SELV), za utikače 01616/ 01617.
Dubina: 24 mm



14332.SL
2P 6 A 24 V (SELV).
Dubina: 23 mm



14333.SL
5-polna DIN 41524 priključnica.
Dubina: 10 mm



14345.SL
USB, vijčani priključci.
Dubina: 30,9 mm



14335
3 RCA, vijčani priključci.
Dubina: 23,4 mm



14347
S-Video, 4 kontakata.
Dubina: 15,5 mm



14346
HDMI, Keystone.
Dubina: 36,4 mm



14346.H
HDMI, Keystone, 90°.
Dubina: 29,4 mm



14335.SL
3 RCA, vijčani priključci.
Dubina: 23,4 mm



14347.SL
S-Video, 4 kontakata.
Dubina: 15,5 mm



14346.SL
HDMI, Keystone.
Dubina: 36,4 mm



14346.H.SL
HDMI, Keystone, 90°.
Dubina: 29,4 mm

Priključnice za prijam signala

Bijelo
Silver

Specijalne priključnice



14583
Opružna spojnica za uređaj za ozvučenje.
Dubina: 18,4 mm



14348
VGA,
15 kontakata
- 2 modula.
Dubina: 10 mm



14361
BNC,
lemljenje.
Dubina: 10 mm



14365
9 kontakata,
SUB D, lemljenje
- 2 modula.
Dubina: 10 mm



14583.SL
Opružna spojnica za uređaj za ozvučenje.
Dubina: 18,4 mm



14348.SL
VGA,
15 kontakata
- 2 modula.
Dubina: 10 mm



14361.SL
BNC,
lemljenje.
Dubina: 10 mm



14365.SL
9 kontakata,
SUB D, lemljenje
- 2 modula.
Dubina: 10 mm

Telefonske priključnice



14320
RJ11,
6-položaja/
4-kontakata
(6/4)
14320.AB
Kao gore,
antibakterijske
obrade.
Dubina: 32,4 mm



14321
RJ12,
6-položaja/
6-kontakata
(6/6).
Dubina: 32,6 mm



14324
Prema izraelskom standardu, vijčani priključci.
Dubina: 32,4 mm



14327
8-kontakata francuski
- 2 modula.
Dubina: 21 mm



14320.SL
RJ11,
6-položaja/
4-kontakata
(6/4).
Dubina: 32,4 mm



14321.SL
RJ12,
6-položaja/
6-kontakata
(6/6).
Dubina: 32,6 mm



14324.SL
Prema izraelskom standardu, vijčani priključci.
Dubina: 32,4 mm



14327.SL
8-kontakata francuski
- 2 modula.
Dubina: 21 mm



14322
RJ11,
6-položaja/
4-kontakata
(6/4) + pokriće.
Dubina: 32,4 mm



14323
RJ12,
6-položaja/
6-kontakata
(6/6) + pokriće.
Dubina: 32,4 mm



14325⁷
BT, MASTER
+ pokriće.
Dubina: 32,4 mm



14326⁷
BT, SLAVE
+ pokriće.
Dubina: 32,4 mm



14322.SL
RJ11,
6-položaja/
4-kontakata
(6/4) + pokriće.
Dubina: 32,4 mm



14323.SL
RJ12,
6-položaja/
6-kontakata
(6/6) + pokriće.
Dubina: 32,4 mm



14325.SL⁷
BT, MASTER
+ pokriće.
Dubina: 32,4 mm



14326.SL⁷
BT, SLAVE
+ pokriće.
Dubina: 32,4 mm

TV-RD-SAT 5-2400 MHz koaksijalne priključnice (izlaza: muški i ženski)



14300.AB.01
Jednostruka,
1 dB,
antibakterijske
obrade.
Dubina: 22,6 mm



14300.01
Jednostruka,
1 dB.
Dubina: 22,6 mm



14300.10
Prolazna,
10 dB.
Dubina: 22,4 mm



14300.01.SL
Jednostruka,
1 dB.
Dubina: 22,6 mm



14300.10.SL
Prolazna,
10 dB.
Dubina: 22,4 mm

Kokasijalne utičnice TV-RD-SAT 5-2400 MHz, nemiješane (2 izlaza: muška i ženska tipa F)



14302.01
Jednostruka, 1 dB
- 2 modula.
Dubina: 22,4 mm



14302.10
Prolazna, 10 dB
- 2 modula.
Dubina: 22,4 mm



14302.01.SL
Jednostruka, 1 dB
- 2 modula.
Dubina: 22,4 mm



14302.10.SL
Prolazna, 10 dB
- 2 modula.
Dubina: 22,4 mm

Priključnice za prijam signala

Bijelo

Silver

Koaksijalne utičnice TV-FM-SAT 5-2400 MHz (3 izlaza: muška i ženska + tip F)



14303
Jednostruka, 1 dB
- 2 modula.
Dubina: 20,5 mm



14303.SL
Jednostruka, 1 dB
- 2 modula.
Dubina: 20,5 mm

Koaksijalna priključnica F tip



14318
F tip.
Dubina:
10 mm



14318.SL
F tip.
Dubina:
10 mm

TV 40-862 MHz koaksijalne priključnice (1 izlaz: ženski)



***14313**
Jednostruka.
Dubina:
28 mm



***14314**
Prolazna
20 dB.
Dubina:
27,5 mm



***14313.SL**
Jednostruka.
Dubina:
28 mm



***14314.SL**
Prolazna
20 dB.
Dubina:
27,5 mm

Adaptori za koaksijalne utičnice TV-RD-SAT



14319
Za 2 ili 3 izlaza
- 2 modula



14319.SL
Za 2 ili 3 izlaza
- 2 modula

Završni otpornici i TV-RD-SAT 2400 MHz koaksijalne priključnice



16330
Z 75 Ω, za
frekvencije do
2400 MHz



01644
Muški, ulaz za
aksijalni kabel



01645
Ženski, ulaz za
aksijalni kabel



01634
Muški, 90°
ulaz za kabel



01635
Ženski, 90°
ulaz za kabel



01654
Muški
tip F za
RG59 kabel

Wi-Fi pristupna točka



▲14195
54 Mb/s s 2 porta LAN 10-100 Mb/s,
ulazom ON/OFF za daljinski gumb,
230 V~ 50/60Hz - 2 modula.
Dubina: 41 mm



▲14195.SL
54 Mb/s s 2 porta LAN 10-100 Mb/s,
ulazom ON/OFF za daljinski gumb,
230 V~ 50/60Hz - 2 modula.
Dubina: 41 mm

Priključnice za prijam signala

Bijelo

Silver

RJ45 podatkovne utičnice

14338.8 Netsafe, Kat. 5e, UTP. Dubina: 22,6 mm	14339.4 Netsafe, Kat. 6, UTP. Dubina: 23,7 mm	14339.5 Netsafe, Kat. 6, FTP. Dubina: 36,5 mm	14339.6 Netsafe, Kat. 6A, FTP. Dubina: 24 mm	14342.AB 8-položaja/ 8-kontakata (8/8), antibakterijske obrade. Dubina: 32,6 mm	14338.8.SL Netsafe, Kat. 5e, UTP. Dubina: 22,6 mm	14339.4.SL Netsafe, Kat. 6, UTP. Dubina: 23,7 mm	14339.5.SL Netsafe, Kat. 6, FTP. Dubina: 36,5 mm	14339.6.SL Netsafe, Kat. 6A, FTP. Dubina: 24 mm
14340.1 Panduit, Cat. 5e, UTP. Dubina: 27,4 mm	14340.2 Panduit, Cat. 5e, FTP. Dubina: 28 mm	14337.6 Kat. 6, UTP, sa zaklopcem. Dubina: 25,1 mm	14339.11 Netsafe, Kat. 5e, UTP. Dubina: 29,3 mm	14340.1.SL Panduit, Cat. 5e, UTP. Dubina: 27,4 mm	14340.2.SL Panduit, Cat. 5e, FTP. Dubina: 28 mm	14337.6.SL Kat. 6, UTP, sa zaklopcem. Dubina: 25,1 mm	14339.11.SL Netsafe, Kat. 5e, UTP. Dubina: 29,3 mm	
14339.13 Netsafe, Kat. 6, UTP. 14339.AB.13 Kao gore, antibakterijske obrade. Dubina: 29,3 mm	14339.14 Netsafe, Kat. 6, FTP. 14339.AB.14 Kao gore, antibakterijske obrade. Dubina: 29,3 mm	14339.15 Netsafe, Kat. 6A, UTP. Dubina: 29,3 mm	14339.16 Netsafe, Kat. 6A, FTP. Dubina: 29,3 mm	14339.13.SL Netsafe, Kat. 6, UTP. Dubina: 29,3 mm	14339.14.SL Netsafe, Kat. 6A, FTP. Dubina: 29,3 mm	14339.15.SL Netsafe, Kat. 6A, UTP. Dubina: 29,3 mm	14339.16.SL Netsafe, Kat. 6A, FTP. Dubina: 29,3 mm	

Adaptori za podatkovne utičnice

▲14337.C RJ45 Keystone + pokriće. Dubina: 10 mm	14338.C RJ45 Kat. 5/6 AMP, Lucent T. Dubina: 10 mm	14340.C MINI-COM Panduit. Dubina: 10 mm	14341.C Kat. 5e i 6 Slim de Infra+, Merlin Gerin. Dubina: 10 mm	14343.K Ukošeni adap- ter za RJ45 Keystone. Dubina: 10 mm	▲14337.C.SL RJ45 Keystone + pokriće. Dubina: 10 mm	14338.SL RJ45 Kat. 5/6 AMP, Lucent T. Dubina: 10 mm	14340.SL MINI-COM Panduit. Dubina: 10 mm	14341.SL Kat. 5e i 6 Slim de Infra+, Merlin Gerin. Dubina: 10 mm	14343.K.SL Ukošeni adap- ter za RJ45 Keystone. Dubina: 10 mm

Utičnice za kabel od optičkog vlakna

14350.SC Jednomodalni 9/125 µm, s adapterom tipa SC/APC simplex. Dubina: 19,4 mm	14350.LC Jednomodalni 9/125 µm, s adapterom tipa LC duplex. Dubina: 19,6 mm	14351.SC Višemodalni 50/125 µm, s adapterom tipa SC simplex. Dubina: 19,4 mm	14351.LC Višemodalni 50/125 µm, s adapterom tipa LC duplex. Dubina: 19,6 mm	14350.SC.SL Jednomodalni 9/125 µm, s adapterom tipa SC/APC simplex. Dubina: 19,4 mm	14350.LC.SL Jednomodalni 9/125 µm, s adapterom tipa LC duplex. Dubina: 19,6 mm	14351.SC.SL Višemodalni 50/125 µm, s adapterom tipa SC simplex. Dubina: 19,4 mm	14351.LC.SL Višemodalni 50/125 µm, s adapterom tipa LC duplex. Dubina: 19,6 mm

Signalizacija

Bijelo

Silver

Elektromehanička zvonca



14370
12 V~ (SELV)
50/60 Hz.
Dubina: 36 mm

14372
120 V~
50/60 Hz.
Dubina: 36 mm

14373
230 V~
50/60 Hz.
Dubina: 36 mm



14370.SL
12 V~ (SELV)
50/60 Hz.
Dubina: 36 mm

14372.SL
120 V~
50/60 Hz.
Dubina: 36 mm

14373.SL
230 V~
50/60 Hz.
Dubina: 36 mm

Elektronska zvonca



14380
3 tonsko (tri/dva tona, zujalica),
napon 12 V~ i 12 Vdc (SELV)
- 2 modula.
Dubina: 36 mm



14380.SL
3 tonsko (tri/dva tona, zujalica),
napon 12 V~ i 12 Vdc (SELV)
- 2 modula.
Dubina: 36 mm

Zujalice



14375
12 V~ (SELV)
50/60 Hz.
Dubina: 36 mm

14377
120 V~
50/60 Hz.
Dubina: 36 mm

14378
230 V~
50/60 Hz.
Dubina: 36 mm



14375.SL
12 V~ (SELV)
50/60 Hz.
Dubina: 36 mm

14377.SL
120 V~
50/60 Hz.
Dubina: 36 mm

14378.SL
230 V~
50/60 Hz.
Dubina: 36 mm

Svijetleće indikatorske jedinice (za signalne jedinice°)



14386.B
Difuzor
Bijeli.
Dubina: 22 mm



14386.B.SL
Difuzor
Bijeli.
Dubina: 22 mm

Dvostruke indikatorske jedinice (za 2 signalne jedinice°)



14388
Neutralni
difuzor.
Dubina: 22 mm



14388.SL
Neutralni
difuzor.
Dubina: 22 mm

Signalizacija

Bijelo

Silver

Prizmatične indikatorske jedinice - 2 modula (za cjevaste žaruljice 14770, 14771, 14776 i 14777 - Isporučuje se bez žaruljice)



14387.B
Difuzor Bijeli.
Dubina: 24 mm



14387.R
Difuzor Crveni.
Dubina: 24 mm



14387.V
Difuzor Zeleni.
Dubina: 24 mm



14387.B.SL
Difuzor Bijeli.
Dubina: 24 mm



14387.R.SL
Difuzor Crveni.
Dubina: 24 mm



14387.V.SL
Difuzor Zeleni.
Dubina: 24 mm

Jedinica za signaliziranje stanja kabine



02685
4 svjetleće žaruljice: IN, Do Not Disturb,
OUT, simbol sobarice, bijela
- 2 modula. Dubina: 22 mm

Svjetiljke za označavanje gazišta



14390
Cu lampa 14770, 14771,
14776, 14777 - 2 modula.
Dubina: 34 mm

Svjetiljke za označavanje gazišta (a LED visoke učinkovitosti)



14389
230 V~ 50/60 Hz
- 2 modula.
Dubina: 36 mm



14381
230 V~ 50/60 Hz
14381.012
12 V~ 50/60 Hz /
12 Vdc (SELV).
Dubina: 36 mm



14389.SL
230 V~ 50/60 Hz
- 2 modula.
Dubina: 36 mm



14381.SL
230 V~ 50/60 Hz
14381.012.SL
12 V~ 50/60 Hz /
12 Vdc (SELV).
Dubina: 36 mm

Elementi za osvjtljavanje



14383
S LEDom visoke efikasnosti
120-230 V~ 50/60 Hz
- 3 modula.
Dubina: 36 mm



14383.SL
S LEDom visoke efikasnosti
120-230 V~ 50/60 Hz
- 3 modula.
Dubina: 36 mm



02670.1
A LED visoke učinkovitosti, 120-230 V~
50/60 Hz, za instalaciju u ugradbene
kutije 7 modula. Dubina: 43 mm

Signalizacija • Zaštita

Bijelo

Silver

TORCIA, elektronska ručna svjetiljka (s automatskim panik uređajem)



14395
S visokom efikasnošću,
230 V~ 50/60 Hz - 2 modula.
Dubina: 39,5 mm



14395.SL
S visokom efikasnošću,
230 V~ 50/60 Hz - 2 modula.
Dubina: 39,5 mm

Panik lampe (s automatskim panik uređajem)



14382
S visokom efikasnošću
230 V~ 50/60 Hz.
Dubina: 36 mm



14384
S visokom efikasnošću
120-230 V~ 50/60 Hz
- 3 modula.
Dubina: 36 mm



14382.SL
S visokom efikasnošću
230 V~ 50/60 Hz.
Dubina: 36 mm



14384.SL
S visokom efikasnošću
120-230 V~ 50/60 Hz
- 3 modula.
Dubina: 36 mm

Panik lampe



02660.1
A LED visoke učinkovitosti, 230 V~ 50/60 Hz,
baterija na punjenje Ni-Cd, za instalaciju u
ugradbene kutije 7 modula. Dubina: 43 mm



14394
230 V~ 50/60 Hz, Ni-Cd baterija, FD 4W
G5 žarulja, upotpunjeno s nosivim okvirom
- 7 modula. Dubina: 43 mm



02662
Prilagodljiva LED žarulja
230 V~ 50 Hz - 3 modula
02662.120
Kao gore, 120 V~.
Dubina: 39 mm



02663
Prilagodljiva LED RGB žarulja
230 V~ 50 Hz - 3 modula
02663.120
Kao gore, 120 V~.
Dubina: 39 mm

Baterija na punjenje



00908
3 x Ni-MH 1,2 V
800 mAh,
HR03 (AAA)



00910
Ni-MH 4,8 V 80 mAh
rezervni dio za TORCIA



00911.1
Ni-Cd 2,4 V 1,3 Ah rezervni
dio za panične svjetiljke



00913
Zamjenska baterija na punjenje
Ni-Cd 4,8 V 800 mAh za 02660.1

Elementi za zaštitu



14416
Noslač osigurača
1P 16 A 250 V~.
Dubina: 39 mm



14418
230 V~ SPD
odvodnik prenapona.
Dubina: 34,3 mm



14416.SL
Noslač osigurača
1P 16 A 250 V~.
Dubina: 39 mm



14418.SL
230 V~ SPD
odvodnik prenapona.
Dubina: 34,3 mm

Zaštita • Detekcija

Bijelo

Silver

1P automatske elektromagnetske sklopke (120-230 V~ 50/60 Hz)



14404.06
C 6, prekidna
moć 1500 A.
Dubina: 38 mm



14404.10
C 10, prekidna
moć 1500 A.
Dubina: 38 mm



14404.16
C 16, prekidna
moć 1500 A.
Dubina: 38 mm



14404.06.SL
C 6, prekidna
moć 1500 A.
Dubina: 38 mm



14404.10.SL
C 10, prekidna
moć 1500 A.
Dubina: 38 mm



14404.16.SL
C 16, prekidna
moć 1500 A.
Dubina: 38 mm

1P+N automatske elektromagnetske sklopke (120-230 V~ 50/60 Hz)



14405.06
C 6, prekidna
moć 1500 A.
Dubina: 38 mm



14405.10
C 10, prekidna
moć 3000 A.
Dubina: 38 mm



14405.16
C 16, prekidna
moć 3000 A.
Dubina: 38 mm



14405.06.SL
C 6, prekidna
moć 1500 A.
Dubina: 38 mm



14405.10.SL
C 10, prekidna
moć 3000 A.
Dubina: 38 mm



14405.16.SL
C 16, prekidna
moć 3000 A.
Dubina: 38 mm

1P+N automatske elektromagnetske sklopke sa strujnom zaštitom (120-230 V~ 50/60 Hz)



14411.06
C 6, $I_{\Delta n}$ 10 mA
prekidna moć
1500 A - 2 modula.
Dubina: 38 mm



14411.10
C 10, $I_{\Delta n}$ 10 mA
prekidna moć
3000 A - 2 modula.
Dubina: 38 mm



14411.06.SL
C 6, $I_{\Delta n}$ 10 mA
prekidna moć
1500 A - 2 modula.
Dubina: 38 mm



14411.10.SL
C 10, $I_{\Delta n}$ 10 mA
prekidna moć
3000 A - 2 modula.
Dubina: 38 mm



14411.16
C 16, $I_{\Delta n}$ 10 mA
prekidna moć
3000 A - 2 modula.
Dubina: 38 mm



14411.16.6
C 16, $I_{\Delta n}$ 6 mA
prekidna moć
3000 A - 2 modula.
Dubina: 38 mm



14411.16.SL
C 16, $I_{\Delta n}$ 10 mA
prekidna moć
3000 A - 2 modula.
Dubina: 38 mm



14411.16.6.SL
C 16, $I_{\Delta n}$ 6 mA
prekidna moć
3000 A - 2 modula.
Dubina: 38 mm

Detektori (230 V~ 50/60 Hz)



14420
Gas Stop Metano, detektor
metana, sredstvo za kontrolu
ventila - 3 modula.
Dubina: 36 mm



14421
Gas Stop GPL, LPG detektor
plina, sredstvo za kontrolu
ventila - 3 modula.
Dubina: 36 mm



14420.SL
Gas Stop Metano, detektor
metana, sredstvo za kontrolu
ventila - 3 modula.
Dubina: 36 mm



14421.SL
Gas Stop GPL, LPG detektor
plina, sredstvo za kontrolu
ventila - 3 modula.
Dubina: 36 mm



01899

Gas Test, bočica s plinom za
testiranje i detekciju LPG-a i metana

Udobnost

Bijelo

Silver

Elektronski termostati (grijanje i klima uređaj)



14440
6(2) A 230 V~
promjenljivi relejni
izlaz - 2 modula.
Dubina: 36 mm



02950.B
Termostat sa zaslonom osjetljivim na dodir,
upravljanje funkcijama ON/OFF i PID temperature,
1 ulaz senzora temperature, 1 višefunkcijski ulaz,
preklopni relejni izlaz 5(2) A 230 V~ - 2 modula.
Dubina: 38,5 mm



14440.SL
6(2) A 230 V~
promjenljivi relejni
izlaz - 2 modula.
Dubina: 36 mm



02950.BN
Termostat sa zaslonom osjetljivim na dodir,
upravljanje funkcijama ON/OFF i PID temperature,
1 ulaz senzora temperature, 1 višefunkcijski ulaz,
preklopni relejni izlaz 5(2) A 230 V~ - 2 modula.
Dubina: 38,5 mm

Elektronski vremenski termostati (grijanje i klima uređaj, 120-230 V~ 50/60 Hz)



02955.B
Termostat sa zaslonom osjetljivim na dodir za upravljanje funkcijama ON/OFF i PID temperature, 1 ulaz senzora temperature, 1 višefunkcijski ulaz, 1 ulaz RJ9 za mjerac energije (02960) preklopni relejni izlaz 5(2) A 230 V~ - 3 modula.
Dubina: 35,3 mm



14445
6(2) A 230 V~
promjenljivi relejni
izlaz, 120-230 V~
50/60 Hz - 2 modula.
Dubina: 36 mm



14446
5(2) A 250 V~ promjenljivi
relejni izlaz, napajanje
baterijom AA LR6 od 1,5 V
(uključena) - 3 modula.
Dubina: 42 mm



02955.BN
Termostat sa zaslonom osjetljivim na dodir za upravljanje funkcijama ON/OFF i PID temperature, 1 ulaz senzora temperature, 1 višefunkcijski ulaz, 1 ulaz RJ9 za mjerac energije (02960) preklopni relejni izlaz 5(2) A 230 V~ - 3 modula.
Dubina: 35,3 mm



14445.SL
6(2) A 230 V~
promjenljivi relejni
izlaz, 120-230 V~
50/60 Hz - 2 modula.
Dubina: 36 mm



14446.SL
5(2) A 250 V~ promjenljivi
relejni izlaz, napajanje
baterijom AA LR6 od 1,5 V
(uključena) - 3 modula.
Dubina: 42 mm

Elektronički senzori



14432
Elektronički senzor
temperature.
Dubina: 23,4 mm



14433
Elektronički senzor vlage 12/24 V,
1 izlaz 0-10 V ili 4-20 mA
- 2 modula.
Dubina: 36 mm



14432.SL
Elektronički senzor
temperature.
Dubina: 23,4 mm



14433.SL
Elektronički senzor vlage 12/24 V,
1 izlaz 0-10 V ili 4-20 mA
- 2 modula.
Dubina: 36 mm

Sklopke za regulaciju ventilatora



14095
Klizna sklopka,
1P 6(2) A 250 V~,
4 položaja.
Dubina: 39 mm



14095.SL
Klizna sklopka,
1P 6(2) A 250 V~,
4 položaja.
Dubina: 39 mm

Mjerač električne energije



02960
Mjerač električne energije, 3 ulaza za senzor 01457,
mogućnost detektiranja snage 50 W-10 kW, instalacija
na vodilicu DIN (60715 TH35), zauzima 1 modul od
17,5 mm. Isporučeno s 01457

Senzor temperature žice



02965.1
Senzor temperature žice,
NTC 10 kΩ,
3 metra

Udobnost • Samostalna rješenja

Bijelo
Silver

Satovi (120-230 V~ 50/60 Hz)



14448
8 A 230 V~ elektronske vremenske sklopke, 1 izlazni relej - 2 modula.
Dubina: 36 mm



14449
Elektronska satovi-budilice - 2 modula.
Dubina: 36 mm



14448.SL
8 A 230 V~ elektronske vremenske sklopke, 1 izlazni relej - 2 modula.
Dubina: 36 mm



14449.SL
Elektronska satovi-budilice - 2 modula.
Dubina: 36 mm

Wi-Fi pristupna točka



▲14195
54 Mb/s s 2 porta LAN 10-100 Mb/s, ulazom ON/OFF za daljinski gumb, 230 V~ 50/60Hz - 2 modula.
Dubina: 41 mm



▲14195.SL
54 Mb/s s 2 porta LAN 10-100 Mb/s, ulazom ON/OFF za daljinski gumb, 230 V~ 50/60Hz - 2 modula.
Dubina: 41 mm

Ozvučenje



21588.B
Pasivni difuzor zvuka 8 Ω 10 W, s ugrađenim okvirom za 8 modula.
Dubina: 48 mm



20587.B
Pasivni difuzor zvuka 8 Ω 3 W - 3 modula.
Dubina: 40 mm



21588.N
Pasivni difuzor zvuka 8 Ω 10 W, s ugrađenim okvirom za 8 modula.
Dubina: 48 mm



20587.N
Pasivni difuzor zvuka 8 Ω 3 W - 3 modula.
Dubina: 40 mm



▲14590
Stereo pojačalo 4+4 W, 2 izlaza za razglase od 8 Ω s ugrađenim prijemnikom *Bluetooth*[®] uz primjenu bežične tehnologije, 1 ulaz LINE IN, napajanje 12 Vdc - 2 modula.
Dubina: 36 mm



▲14590.SL
Stereo pojačalo 4+4 W, 2 izlaza za razglase od 8 Ω s ugrađenim prijemnikom *Bluetooth*[®] uz primjenu bežične tehnologije, 1 ulaz LINE IN, napajanje 12 Vdc - 2 modula.
Dubina: 36 mm



01831
Napojna jedinica 12 Vdc 1250 mA, 100-240 V~ 50/60 Hz, 1,5 modula x 17,5 mm

Samostalna rješenja

Bijelo

Silver

Radiofrekvencijski komplet



▲ 0K03906.02

Komplet Friends of Hue. Sadrži sljedeće:

- 1 komandu s 4 radiofrekvencijska gumba 03906
- 1 nosač 20507.B
- 2 tipke 14506, bijele
- 1 pokrovnu masku s 2 modula 14642.01, bijelu
- 1 pokrovnu masku s 2 središnja modula 14652.01, bijelu



Samostojni radiofrekvencijski aparati



▲ 03955

Ravna komanda s 4 gumba s radiofrekvencijskim predajnikom od 868.3 MHz standard **EnOcean**®, nadopuniti namjenskim tipkama 14506... - 2 modula



01796.1

Višefunkcijski aktivator EnOcean® s relejnim izlazom NO 8 A 230 V~, napajanje 230 V~ 50/60 Hz



▲ 03925

Ravna komanda s 4 gumba s radiofrekvencijskim predajnikom od 2.4 GHz i primjenom tehnologije **Bluetooth**® Low Energy *wireless technology*, nadopuniti namjenskim tipkama 14506... - 2 modula



03905

Ravna komanda s 4 gumba s radiofrekvencijskim predajnikom od 2.4 GHz standard **ZigBee Green Power**, nadopuniti namjenskim tipkama 14506... - 2 modula



■ 03906

Ravna komanda s 4 gumba s radiofrekvencijskim predajnikom od 2.4 GHz standard **ZigBee Green Power** i **Friends of Hue**, nadopuniti namjenskim tipkama 14506... - 2 modula



20507.B

Nosač za zidnu ugradnju za radiofrekvencijske komande, bijele



20507

Nosač za zidnu ugradnju za radiofrekvencijske komande, sivi



14506

Par tipaka za 1 modul za radiofrekvencijske komande, mogućnost personalizacije



14506.2

Tipka za 2 modula za radiofrekvencijske komande, mogućnost personalizacije



14506.SL

Par tipaka za 1 modul za radiofrekvencijske komande, mogućnost personalizacije



14506.2.SL

Tipka za 2 modula za radiofrekvencijske komande, mogućnost personalizacije

Samostalna rješenja

Bijelo
Silver

Sustav kontrole pristupa



14461
Čitač/programator chipkartice,
12-24 V~ 50/60 Hz /
12-24 Vdc (SELV)
- 3 modula. Dubina: 36 mm



14461.SL
Čitač/programator chipkartice,
12-24 V~ 50/60 Hz /
12-24 Vdc (SELV)
- 3 modula. Dubina: 36 mm



14463
Bedž sklopka,
120-230 V~ 50/60 Hz
- 2 modula.
Dubina: 20,5 mm



14465
Bedž sklopka, 230 V~
50/60 Hz i 24 Vdc (SELV)
- 3 modula.
Dubina: 36 mm



14463.SL
Bedž sklopka,
120-230 V~ 50/60 Hz
- 2 modula.
Dubina: 20,5 mm



14465.SL
Bedž sklopka, 230 V~
50/60 Hz i 24 Vdc (SELV)
- 3 modula.
Dubina: 36 mm



14468
Elektronički čitač NFC/
RFID, kompatibilan s
elektroničkim rješenjima
AGB za hotele,
okomiti džep, 120-230 V~
50/60 Hz - 3 modula.
Dubina: 29,5 mm



14468.1
Elektronički čitač NFC/
RFID, kompatibilan s
elektroničkim rješenjima
CISA za hotele,
okomiti džep, 120-230 V~
50/60 Hz - 3 modula.
Dubina: 30,5 mm



14468.SL
Elektronički čitač NFC/
RFID, kompatibilan s
elektroničkim rješenjima
AGB za hotele,
okomiti džep, 120-230 V~
50/60 Hz - 3 modula.
Dubina: 29,5 mm



14468.1.SL
Elektronički čitač NFC/
RFID, kompatibilan s
elektroničkim rješenjima
CISA za hotele,
okomiti džep, 120-230 V~
50/60 Hz - 3 modula.
Dubina: 30,5 mm



16452
Programabilna chip-kartica
16452.H
Kao gore, s mogućnošću
personalizacije



16452.S
ISO kartica (Bedž)

Samostalna rješenja

Bijelo

Silver

Sustav kontrole pristupa Bus



14470
Transponder ključ i kartični čitač - 2 modula.
Dubina: 25,5 mm



14471
Čitač/programator - 3 modula.
Dubina: 36 mm



14472
Aktivator promjenljivim relejom 3 A 30 V - 2 modula.
Dubina: 25,5 mm



14470.SL
Transponder ključ i kartični čitač - 2 modula.
Dubina: 25,5 mm



14471.SL
Čitač/programator - 3 modula.
Dubina: 36 mm



14472.SL
Aktivator promjenljivim relejom 3 A 30 V - 2 modula.
Dubina: 25,5 mm

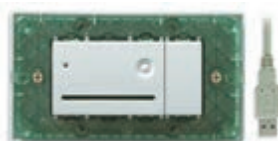

14473
Programator pametne kartice u kutiji za stolnu montažu - 4 modula



14473.SL
Programator pametne kartice u kutiji za stolnu montažu - 4 modula



01816
Transponder-kartica

01816.H
Kao gore, s mogućnošću personalizacije



01815
Transponder ključ



16452
Programabilna chip-kartica
16452.H
Kao gore, s mogućnošću personalizacije



16474
Pametna kartica za serijski spoj čitača/programatora



01400
Napojna jedinica, 29 Vdc, 400 mA, 230 V~ 50/60 Hz, 2 modula x 17,5 mm



01401
Napojna jedinica, 29 Vdc, 1280 mA, 120-230 V~ 50/60 Hz, 8 modula x 17,5 mm

Videoportafonija



21554.B
Video zaslon osjetljiv na dodir 4,3" Full Flat za unutarnje videoportafonsko mjesto Due Fili Plus za nadzor i komandu, ulaz za senzor temperature, upotpunjen nosačem za ugradnju u kutije s 8 modula.
Dubina: 46,7 mm



21554.BN
Video zaslon osjetljiv na dodir 4,3" Full Flat za unutarnje videoportafonsko mjesto Due Fili Plus za nadzor i komandu, ulaz za senzor temperature, upotpunjen nosačem za ugradnju u kutije s 8 modula.
Dubina: 46,7 mm



01963
Modul video-portafona Due Fili Plus



14557
Hands-free portafon za Due Fili sustav - 3 modula.
Dubina: 36 mm



14577
Tipkalo poziva Due Fili sustav - 3 modula.
Dubina: 36 mm



14557.SL
Hands-free portafon za Due Fili sustav - 3 modula.
Dubina: 36 mm



14577.SL
Tipkalo poziva Due Fili sustav - 3 modula.
Dubina: 36 mm



14560
Unutarnja kolor kamera.
Dubina: 36 mm



14565
Unutarnja kolor kamera - 2 modula.
Dubina: 25,5 mm



14570
Unutarnje LED-svjetlo.
Dubina: 36 mm



14560.SL
Unutarnja kolor kamera.
Dubina: 36 mm



14565.SL
Unutarnja kolor kamera - 2 modula.
Dubina: 25,5 mm



14570.SL
Unutarnje LED-svjetlo.
Dubina: 36 mm

Samostalna rješenja

Bijelo

Silver

By-alarm: protuprovalni sustav



01700
Središnja upravljačka jedinica,
230 V~ 50 Hz, 8 lokalnih ulaza
koje je moguće proširiti na 24,
zidna ugradnja

01700.DE
Kao gore,
verzija na njemačkom

01700.120
Kao gore, 120 V~ 60 Hz



01703
Središnja upravljačka jedinica,
230 V~ 50 Hz, 8 lokalnih ulaza
koje je moguće proširiti na 64,
zidna ugradnja

01703.DE
Kao gore,
verzija na njemačkom

01703.120
Kao gore, 120 V~ 60 Hz



01705
Tipkovnica s LED svjetlima
i zaslonom, 12 Vdc, zidna
ugradnja

01705.DE
Kao gore,
verzija na njemačkom



01715
Vanjska sirena

01716
Vanjska lažna sirena



01717
Dodatni uređaj za napajanje
električnom energijom, 230 V~
50/60 Hz 1,5 A, zidna ugradnja

01717.120
Kao gore, 120 V~



01704
Modul za proširenje
s 8 ulaza



01709
Modul za proširenje
s 4 ulaza



01710
Modul za proširenje s
4 izlaza



01711
Izolirano sučelje za
regeneraciju signala
sabirnice



01713.EN
Modul za govornu
sintezu za središnju
upravljačku jedinicu,
na engleskom



01707
Antena velikog
pojačanja GSM
Dual Band



01708
Komunikator PSTN za
središnju upravljačku
jedinicu



01706
Modul predajnika/prijamnika GSM
Dual Band GSM/GPRS 900/1800 MHz



01712
Sučelje za ethernetsku mrežu
(LAN) i domotički sustav By-me
(putem Web poslužitelja 01945,
01946), nadzor/daljinsko i lokalno
upravljanje putem protokola IP



01714
Kutija sa zaštitom od trganja
za module za proširenje,
zidna ugradnja



01725
Sučelja i konfiguracijski
kabeli



01736
Produžni kabel za antenu
komunikatora By-alarm
GSM Dual Band 01706,
duljine 10 m



14478
Aktivator/
parcijalizator.
Dubina:
40,4 mm



14479
IC i mikrovalni
detektor prisutnosti
- 2 modula.
Dubina: 25,5 mm



14496
Unutarnja sirena
- 3 modula.
Dubina: 36 mm



14478.SL
Aktivator/
parcijalizator.
Dubina:
40,4 mm



14479.SL
IC i mikrovalni
detektor prisutnosti
- 2 modula.
Dubina: 25,5 mm



14496.SL
Unutarnja sirena
- 3 modula.
Dubina: 36 mm



01718.G
Transponder ključ,
zelena



01718.Y
Transponder ključ,
žuta

Samostalna rješenja

Bijelo

Silver

By-alarm: protuprovalni sustav



01720
Detektor s dvostrukom tehnologijom na infracrveno zračenje i mikrovalove, prepoznavanje kućnih ljubimaca, zidna ugradnja



01721
Detektor s dvostrukom tehnologijom na infracrveno zračenje i mikrovalove, djeluje protiv maskiranja i protiv šuljanja, zidna ugradnja



01723
Detektor s primjenom dvostruke tehnologije, zavjesni, IP54 za vanjsku upotrebu za prolaze i okvire, zidna ugradnja



01820
Magnetni kontakt za podžbuknu montažu



01722
Detektor s primjenom dvostruke tehnologije, zavjesni za prolaze i okvire, zidna ugradnja



01724
Detektor vode za zaštitu od poplave, podna ugradnja



01821
Metalni magnetni kontakt za podžbuknu montažu



01822
Magnetni kontakt za vidljivu montažu



01823
Magnetski kontakt u metalnom spremniku za ugradnju po viđenju



01825
Elektromehanički žični kontakt za rolete



01826
Elektromehanički tromi kontakt za prozore i staklene stijenke



01732.E
Kabel za By-alarm sustav, 2x0,22 mm², s oblogom od materijala LSZH, klasa CPR Eca, adekvatna za instalaciju u području de Categoria I (U₀ = 400 V), bijelo - 100 m



01733.E
Kabel za By-alarm sustav, 2x0,50 mm² + 2x0,22 mm², s oblogom od materijala LSZH, klasa CPR Eca, adekvatna za instalaciju u području de Categoria I (U₀ = 400 V), bijelo - 100 m



01734.E
Kabel za By-alarm sustav, 2x0,50 mm² + 4x0,22 mm², s oblogom od materijala LSZH, klasa CPR Eca, adekvatna za instalaciju u području de Categoria I (U₀ = 400 V), bijelo - 100 m



01735.E
Kabel za By-alarm sustav, 2x0,50 mm² + 6x0,22 mm², s oblogom od materijala LSZH, klasa CPR Eca, adekvatna za instalaciju u području de Categoria I (U₀ = 400 V), bijelo - 100 m

Radiofrekvencijski uređaji



01727
Detektor s magnetskim kontaktom za vrata i prozore



01728
Detektor na infracrveno zračenje



01731
Detektor s primjenom dvostruke tehnologije IP54, zavjesni za vanjsku upotrebu za prolaze i okvire



01729
Radiofrekvencijsko dvosmjerno sučelje na 868 MHz



01730
Daljinski upravljač za radiofrekvencijsko dvosmjerno sučelje na 868 MHz

Bijelo

Silver

By-me: nadgledanje



21554.B
Video zaslon osjetljiv na dodir 4,3" Full Flat za unutarnje videoportafonsko mjesto Due Fili Plus za nadzor i komandu, ulaz za senzor temperature, upotpunjen nosačem za ugradnju u kutije s 8 modula. Dubina: 46,7 mm



21554.BN
Video zaslon osjetljiv na dodir 4,3" Full Flat za unutarnje videoportafonsko mjesto Due Fili Plus za nadzor i komandu, ulaz za senzor temperature, upotpunjen nosačem za ugradnju u kutije s 8 modula. Dubina: 46,7 mm



01963°
Modul video-portafona Due Fili Plus



21511.1.B
4,3" Full Flat, za nadzor, senzor temperature, s ugrađenim nosačem za 8 modula. Dubina: 39,9 mm



21512.1.B
Za nadzor, senzor temperature - 3 modula. Dubina: 37 mm



21511.1.BN
4,3" Full Flat, za nadzor, senzor temperature, s ugrađenim nosačem za 8 modula. Dubina: 39,9 mm



21512.1.BN
Za nadzor, senzor temperature - 3 modula. Dubina: 37 mm



21509.B
Za kontrolu i konfiguriranje, zaslon osjetljiv na dodir, 1 ulaz za senzor temperature, isporučuje se s dodatnim priborom V51923 za instalaciju na vodilicu DIN (60715 TH35) - 3 modula. Upotpunjen konektorom RJ45, kabelom i dodatnim priborom V51921. Dubina: 37 mm



V51921



V51923



21509.N
Za kontrolu i konfiguriranje, zaslon osjetljiv na dodir, 1 ulaz za senzor temperature, isporučuje se s dodatnim priborom V51923 za instalaciju na vodilicu DIN (60715 TH35) - 3 modula. Upotpunjen konektorom RJ45, kabelom i dodatnim priborom V51921. Dubina: 37 mm



V51921



V51923



App By-phone**

01942
GSM telefonski poziv, s Bus konekcijom, 12-24 V~ 50/60 Hz ili 12-30 Vdc, 6 modula x 17,5 mm



App By-web**

01945
Web poslužitelj za lokalno i daljinsko nadgledanje sustava By-me putem IP adrese, 8 modula x 17,5 mm



App By-web**

01946
Web poslužitelj Light za lokalno i daljinsko nadgledanje sustava By-me putem IP adrese, upravljanje s do 64 uređaja, 8 modula x 17,5 mm



01993
Hardversko sučelje za programiranje sustava i uređaja By-me putem povezivanja na sabirnicu utičnicom RJ11. Potrebno je koristiti softver EasyTool Professional

Bijelo

Silver

By-me: nadgledanje



01468
Jedinica za implementaciju logičkih, matematičkih i vremenskih funkcija i poruka,
1 modula x 17,5 mm



01400
Napojna jedinica,
29 Vdc, 400 mA,
230 V~ 50/60 Hz,
2 modula x 17,5 mm



01401
Napojna jedinica,
29 Vdc, 1280 mA,
120-230 V~ 50/60 Hz,
8 modula x 17,5 mm



01830
Napojna jedinica
12 Vdc, 120-230 V~
50/60 Hz,
4 modula x 17,5 mm



01831
Napojna jedinica
12 Vdc 1250 mA,
100-240 V~ 50/60 Hz,
1,5 modula x 17,5 mm



01845.1
Uređaj za spajanje linija,
2 modula x 17,5 mm



14580
Napajač s
izlazom 32 Vdc
100 mA,
110-230 V~
50/60 Hz.
Dubina: 39 mm



14580.SL
Napajač s
izlazom 32 Vdc
100 mA,
110-230 V~
50/60 Hz.
Dubina: 39 mm



14329
Specijalni jack za Bus,
vijčani priključci.
Dubina: 32,6 mm



14329.SL
Specijalni jack za Bus,
vijčani priključci.
Dubina: 32,6 mm



01840.E
Kabel za Bus sustav, 2x0,50 mm²,
s oblogom od materijala LSZH,
klasa CPR Eca, adekvatna za instalaciju
s kablima de Kategorija I (U₀ = 400 V), bijelo - 100 m



01841.E
Kabel za Bus sustav, 2x0,50 mm²,
oklopljen, s oblogom od materijala
LSZH, klasa CPR Eca, adekvatna
za instalaciju s kablima de Kategorija I
(U₀ = 400 V), bijelo - 100 m



▲01840.C
Kabel za Bus sustav, 2x0,50 mm²,
s oblogom od materijala LSZH,
klasa CPR Cca s1b d1 a1,
adekvatna za instalaciju s kablima de Kategorija I
(U₀ = 400 V), žuti - 100 m



01839
Odstranjiva
2-kontaktna
stezaljka

Bijelo

Silver

By-me: kontrola i funkcije



▲01480
4 gumba
- 2 modula
▲01480.TR
Kao gore,
tropicaliziran.
Dubina: 20 mm



▲01481
4 gumba+ aktivator
releja NO 16 A 120-
240 V~ 50/60 Hz
- 2 modula
Dubina: 37 mm



▲01482
4 gumba + aktivator 1
rolete s usmjeravanjem
lamela , relejni izlaz
za motor cosφ 0,6 2 A
120-240 V~ 50/60 Hz
- 2 modula
Dubina: 37 mm



▲01485
6 gumba
- 3 modula
▲01485.TR
Kao gore,
tropicaliziran.
Dubina: 20 mm



▲01486
6 gumba+ aktivator
releja NO 16 A 120-
240 V~ 50/60 Hz
- 3 modula
Dubina: 37 mm



▲01487
6 gumba + aktivator 1
rolete s usmjeravanjem
lamela , relejni izlaz
za motor cosφ 0,6 2 A
120-240 V~ 50/60 Hz
- 3 modula
Dubina: 37 mm

2 međusobno zamjenjive polutipke s 1 i 2 modula



▲14751
Neutralne,
uz mogućnost
personalizacije



▲14751.0
Fiksne,
neutralne



▲14751.1
Simboli
ON/OFF



▲14751.2
Simboli
strelice



▲14751.3
Simboli
regulacije



▲14751.SL
Neutralne,
uz mogućnost
personalizacije



▲14751.0.SL
Fiksne,
neutralne



▲14751.1.SL
Simboli
ON/OFF



▲14751.2.SL
Simboli
strelice



▲14751.3.SL
Simboli
regulacije



▲14752
Neutralne,
uz mogućnost
personalizacije



▲14752.1
Simboli
ON/OFF



▲14752.2
Simboli
strelice



▲14752.3
Simboli
regulacije

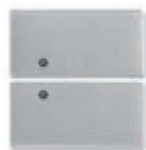

▲14752.SL
Neutralne,
uz mogućnost
personalizacije



▲14752.1.SL
Simboli
ON/OFF



▲14752.2.SL
Simboli
strelice



▲14752.3.SL
Simboli
regulacije



14529
2 polužne sklopke
+ SLAVE -regulacijski
- 2 modula.
Dubina: 37 mm



14529.120
2 polužne sklopke + 120 V~
SLAVE -regulacijski
- 2 modula.
Dubina: 37 mm



14549
3 polužne sklopke +
40-300 W 40-200 VA
MASTER regulator
aktivator - 3 modula.
Dubina: 36 mm

2 međusobno zamjenjive polutipke s 1 i 2 modula



Δ 14531
No simbol,
za obične
sklopke



Δ 14531.10
S općim
simbolom za
obične sklopke



Δ 14531.20
S ON i OFF
simbolom, za
polužne sklopke



Δ 14531.21
Sa strelicama,
za polužne
sklopke



Δ 14531.SL
No simbol,
za obične
sklopke



Δ 14531.10.SL
S općim
simbolom za
obične sklopke



Δ 14531.20.SL
S ON i OFF
simbolom, za
polužne sklopke



Δ 14531.21.SL
Sa strelicama,
za polužne
sklopke

Bijelo

Silver

By-me: kontrola i funkcije

2 međusobno zamjenjive polutipke s 1 i 2 modula



Δ 14531.25
Simboli univerzalne regulacije za poluzne sklopke



Δ 14531.1T
S natpisnom pločicom za obične sklopke



Δ 14531.2T
S 2 natpisne pločice za poluzne sklopke



Δ 14531.S
No simbol, za poluzne sklopke



Δ 14531.25.SL
Simboli univerzalne regulacije za poluzne sklopke



Δ 14531.1T.SL
S natpisnom pločicom za obične sklopke



Δ 14531.2T.SL
S 2 natpisne pločice za poluzne sklopke

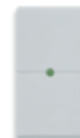

Δ 14531.S.SL
No simbol, za poluzne sklopke



Δ 14532
No simbol, za obične sklopke



Δ 14532.10
S općim simbolom za obične sklopke



Δ 14532.20
S ON i OFF simbolom, za poluzne sklopke



Δ 14532.21
Sa strelicama, za poluzne sklopke



Δ 14532.SL
No simbol, za obične sklopke



Δ 14532.10.SL
S općim simbolom za obične sklopke



Δ 14532.20.SL
S ON i OFF simbolom, za poluzne sklopke



Δ 14532.21.SL
Sa strelicama, za poluzne sklopke



Δ 14532.25
Simboli univerzalne regulacije za obične sklopke



Δ 14532.1T
S natpisnom pločicom za obične sklopke



Δ 14532.S
No simbol, za poluzne sklopke



Δ 14532.22.SL
Sa simbolom regulacije za poluzne sklopke



Δ 14532.25.SL
Simboli univerzalne regulacije za obične sklopke



Δ 14532.1T.SL
S natpisnom pločicom za obične sklopke



Δ 14532.S.SL
No simbol, za poluzne sklopke

Detektori



19516
IC prijemnik za daljinski upravljač - 2 modula.
Dubina: 25,5 mm



14516.SL
IC prijemnik za daljinski upravljač - 2 modula.
Dubina: 25,5 mm



01849
14-kanalni IC daljinski upravljač



01828
Mini IC detektor prisutnosti



14485
IC detektor prisutnosti - 2 modula.
Dubina: 25,5 mm



00802
Orijentabilni podložak - 2 modula



00805
Adaptor za podžbuknu montažu za orijentabilne podloške.
Dubina: 36,5 mm



00800
Okvir za nadžbuknu montažu za orijentabilne podloške



14485.SL
IC detektor prisutnosti - 2 modula.
Dubina: 25,5 mm



00802.20
Orijentabilni podložak - 2 modula



00805.20
Adaptor za podžbuknu montažu za orijentabilne podloške.
Dubina: 36,5 mm



00800.20
Okvir za nadžbuknu montažu za orijentabilne podloške

Bijelo

Silver

By-me: kontrola i funkcije

Sučelja, aktivatori i prigušnici



14518
Sučelje za tradicionalne sklopke.
Dubina: 39 mm



14515
Interface za tradicionalne kontakte 230 V~ / 12-24 V ac/dc - 2 modula.
Dubina: 36 mm



14584.1
Sučelje za za prijenos upravljačkih sklopova By-me prijammiku IR, opremljen kabelom 3 m.
Dubina: 40 mm



14518.SL
Sučelje za tradicionalne sklopke.
Dubina: 39 mm



14515.SL
Interface za tradicionalne kontakte 230 V~ / 12-24 V ac/dc - 2 modula.
Dubina: 36 mm



14584.1.SL
Sučelje za za prijenos upravljačkih sklopova By-me prijammiku IR, opremljen kabelom 3 m.
Dubina: 40 mm



14534
Aktuator 6 A 120-230 V~ preklopni relejni izlaz.
Dubina: 39 mm



14535
Aktivator, 16 A 120-230 V~ promjenljivi relejni izlaz - 2 modula.
Dubina: 36 mm



14534.SL
Aktuator 6 A 120-230 V~ preklopni relejni izlaz.
Dubina: 39 mm



14535.SL
Aktivator, 16 A 120-230 V~ promjenljivi relejni izlaz - 2 modula.
Dubina: 36 mm



01475
Modul s 3 digitalna programabilna ulaza za kontakte bez potencijala, 3 izlaza za pilotiranje s LED svjetlom, domotički sustav By-me, ugradbena instalacija (stražnji trup spojnice)



01476
Modul sa 2 digitalna programabilna ulaza za kontakte bez potencijala, 1 relejni izlaz za jednu roletu s usmjeravanjem lamela za motor cosφ 0.6 2 A 120-230 V~, 2 izlaza za pilotiranje s LED svjetlom, domotički sustav By-me, ugradbena instalacija (stražnji trup spojnice)



01477
Modul s 2 digitalna programabilna ulaza za kontakte bez potencijala, 1 relejni izlaz za upravljanje svjetlima NO 10 A 120-230 V~ 50/60 Hz, 2 izlaza za pilotiranje s LED svjetlom, domotički sustav By-me, ugradbena instalacija (stražnji trup spojnice)



01470
Modul s prethodno programiranih 9 ulaza i 8 izlaza, NO 16 A 120-230 V~ 50/60 Hz s funkcijom upravljanja svjetlima, rolete s usmjeravanjem lamela, gumbi za lokalno upravljanje, 6 modula x 17,5 mm



01471
Aktivator s 4 preklopna relejna izlaza 16 A 120-230 V~, programabilna s funkcijom upravljanja svjetlima, roletama s usmjeravanjem lamela, ventilokonvektorom, gumbima za lokalno upravljanje, 4 modula x 17,5 mm



01850.2
Aktivator relejnog izlaza u razmjeni 16 A 120-230 V~ + tipka za lokalno upravljanje, 2 modula x 17,5 mm



01856
Aktivator za kontrolu prigušnica, promjenljivi relejni izlaz, 120-230 V~, 3 modula x 17,5 mm



***01861**
MASTER regulator, 40-1000 W/VA, 230 V~, MOSFET+TRIAC, 4 modula x 17,5 mm



***01862**
SLAVE regulator, 40-1000 W/VA, 230 V~, MOSFET+TRIAC, 4 modula x 17,5 mm



01863
MASTER regulator, 40-800 W/VA 50 Hz, 40-700 W/VA 60 Hz, 230 V~, MOSFET + TRIAC, 4 modula x 17,5 mm



01864
SLAVE regulator, 40-800 W/VA 50 Hz, 40-700 W/VA 60 Hz, 230 V~, MOSFET + TRIAC, 4 modula x 17,5 mm



***01865**
MASTER regulator, 40-700 VA, 230 V~ 50/60 Hz, MOSFET, 4 modula x 17,5 mm



***01866**
SLAVE regulator, 40-700 VA, 230 V~ 50/60 Hz, MOSFET, 4 modula x 17,5 mm



01867
MASTER regulator, 40-500 VA 50 Hz, 40-400 VA 60 Hz, 230 V~, MOSFET, 4 modula x 17,5 mm



01868
SLAVE regulator, 40-500 VA 50 Hz, 40-400 VA 60 Hz, 230 V~, MOSFET, 4 modula x 17,5 mm

Bijelo

Silver

By-me: kontrola i funkcije

Sučelja, aktivatori i prigušnici



01870
MASTER regulator,
40-500 W, 40-300 VA,
CFL 10-200 W,
LED 3-200 W, 230 V~,
4 modula x 17,5 mm

01870.120
Kao gore, 120 V~



01871
SLAVE regulator,
40-500 W, 40-300 VA,
CFL 10-200 W,
LED 3-200 W, 230 V~,
4 modula x 17,5 mm

01871.120
Kao gore, 120 V~



01975
Aktivator s 1 izlazom
1-10 Vdc 30 mA za
upravljanje LED
diodama, 1 preklopni
relejni izlaz
120-230 V~ 2,5 A,
120-230 V~ 50/60 Hz,
3 modula x 17,5 mm



01976
Aktivator s 1 izlazom
1-10 Vdc 30 mA za
upravljanje LED
diodama, 1 relejni
izlaz 12-24 V 10 A,
12-24 V~ 50/60 Hz
ili 12-24 Vdc,
3 modula x 17,5 mm



01466
Aktivator sa 4 analogna
proporcionalna izlaza
(0)4-20 mA ili 0-10 V i
maksimalnim izlaznim
naponom s mogućnošću
ponovnog skaliranja,
120-230 V~ 50/60 Hz,
3 modula x 17,5 mm



01467
Uređaj s 3 analogna
ulaza za signal,
1 ulaz 0-10 V ili
4-20 mA, 1 ulaz za
senzor NTC, 1 ulaz za
senzor osvijetljenosti
01530, 2 modula x 17,5 mm

Elektroničko napajanje



01874
230 V~ 50 Hz, Za prilagodljive
LED žarulje od 12-24 Vdc

01874.120
Kao gore, 120 V~



01875
230 V~ 50 Hz, za prilagodljive
LED žarulje od 350/500/700 mA

01875.120
Kao gore, 120 V~



01876
230 V~ 50 Hz, za prilagodljive
svjetiljke LED RGB od 12-24 Vdc

01876.120
Kao gore, 120 V~



01877
230 V~ 50 Hz, za prilagodljive
LED RGB žarulje od 12-24 Vdc

01877.120
Kao gore, 120 V~

Automatizacija pomoću radiofrekvencije



▲03955
Ravna komanda s 4 gumba s
radiofrekvencijskim predajnikom od
868.3 MHz standard **EnOcean®**,
nadopuniti namjenskim tipkama
14506... - 2 modula



01796.1
Višefunkcijski aktivator EnOcean®
s relejnim izlazom NO 8 A 230 V~,
napajanje 230 V~ 50/60 Hz



20507.B
Nosач za zidnu ugradnju za
radiofrekvencijske komande,
bijeje



20507
Nosач za zidnu ugradnju za
radiofrekvencijske komande, sivi



14506
Par tipaka za 1 modul
za radiofrekvencijske
komande, mogućnost
personalizacije



14506.2
Tipka za 2 modula
za radiofrekvencijske
komande, mogućnost
personalizacije



14508
Sučelje Bus-RF
- 2 modula.
Dubina: 25,5 mm



14506.SL
Par tipaka za 1 modul
za radiofrekvencijske
komande, mogućnost
personalizacije



14506.2.SL
Tipka za 2 modula
za radiofrekvencijske
komande, mogućnost
personalizacije



14508.SL
Sučelje Bus-RF
- 2 modula.
Dubina: 25,5 mm

Bijelo

Silver

By-me: ozvučenje

Uređaji



14583
Opružna spojnica za uređaj za ozvučenje.
Dubina: 18,4 mm



14582
Audio ulaz s 2 konektora RCA, automatsko podešavanje glasnoće, uklopljeni terminator linije - 2 modula.
Dubina: 36 mm



14583.SL
Opružna spojnica za uređaj za ozvučenje.
Dubina: 18,4 mm



14582.SL
Audio ulaz s 2 konektora RCA, automatsko podešavanje glasnoće, uklopljeni terminator linije - 2 modula.
Dubina: 36 mm



▲14589
Sučelje Bluetooth®, mogućnost memoriranja do 8 pokretnih uređaja - 2 modula.
Dubina: 37 mm



▲14590
Stereo pojačalo 4+4 W, 2 izlaza za razglase od 8 Ω s ugrađenim prijemnikom *Bluetooth*® uz primjenu bežične tehnologije, 1 ulaz LINE IN, napajanje 12 Vdc - 2 modula.
Dubina: 36 mm



▲14589.SL
Sučelje Bluetooth®, mogućnost memoriranja do 8 pokretnih uređaja - 2 modula.
Dubina: 37 mm



▲14590.SL
Stereo pojačalo 4+4 W, 2 izlaza za razglase od 8 Ω s ugrađenim prijemnikom *Bluetooth*® uz primjenu bežične tehnologije, 1 ulaz LINE IN, napajanje 12 Vdc - 2 modula.
Dubina: 36 mm



14586
Mikrofon za selektivni ili opći poziv, funkcija aktiviranja glasom za kontrolu djece - 2 modula.
Dubina: 36 mm



14586.SL
Mikrofon za selektivni ili opći poziv, funkcija aktiviranja glasom za kontrolu djece - 2 modula.
Dubina: 36 mm



▲01483
4 gumba, 1 izlaz LINE OUT, nadopuniti s 2 međusobno zamjenjive tipke s 1 ili 2 modula - 2 modula.
Dubina: 37 mm



▲01484
4 gumba sa stereo pojačalom 1+1 W RMS, 2 izlaza za razglase od 8 Ω, nadopuniti s 2 međusobno zamjenjive polutipke s 1 ili 2 modula - 2 modula.
Dubina: 37 mm

2 međusobno zamjenjive polutipke s 1 modulom



▲14751.4
Simboli glasnoće I i O



▲14751.5
Simboli promjene funkcije i praćenja



▲14751.4.SL
Simboli glasnoće I i O



▲14751.5.SL
Simboli promjene funkcije i praćenja

Bijelo

Silver

By-me: ozvučenje

Razglasi i komponente sustava



21588.B
Pasivni difuzor zvuka 8 Ω 10 W, s ugrađenim okvirom za 8 modula.
Dubina: 48 mm



20587.B
Pasivni difuzor zvuka 8 Ω 3 W - 3 modula.
Dubina: 48 mm



21588.N
Pasivni difuzor zvuka 8 Ω 10 W, s ugrađenim okvirom za 8 modula.
Dubina: 48 mm



20587.N
Pasivni difuzor zvuka 8 Ω 3 W - 3 modula.
Dubina: 48 mm



01906
Pasivni difuzor zvuka IP55 8 Ω 30 W, ugradnja u lagane zidove i spuštene strop.
Dubina: 70 mm



01907
Pasivni difuzor zvuka 8 Ω 30 W, ugradnja u lagane zidove i spuštene strop.
Dubina: 68 mm



01908
Pasivni difuzor zvuka 8 Ω 30 W koji se može usmjeriti, zidna ugradnja



01903
Derivator za upravljačke uređaje By-me, ugradbena instalacija (stražnji trup spojnice)



01904
Sporedni derivator za uređaje za ozvučenje, ugradbena instalacija (stražnji trup spojnice)



01900
Radio tuner FM sa RDS-om, koaksijalni konektor za vanjsku FM antenu, uklopljeni terminator linije, 2 modula x 17,5 mm



01901
Stereo pojačalo 2 izlaza za difuzore zvuka 8 Ω 10 + 10 W, napajanje 110-230 V~ 50/60 Hz, uklopljeni terminator linije, 6 modula x 17,5 mm



01902
Rastavljač linije Bus/ozvučenje za napajač By-me, uklopljeni terminator linije, 2 modula x 17,5 mm



01831
Napojna jedinica 12 Vdc 1250 mA, 100-240 V~ 50/60 Hz, 1,5 modula x 17,5 mm



01840.E.B
Kabel za ozvučenje, 2x0,50 mm², s oblogom od materijala LSZH, klasa CPR Eca, adekvatna za instalaciju u kablu de Categoria I (U0 = 400 V), plavi - 100 m



01839
Odstranjiva 2-kontaktna stezaljka

Bijelo

Silver

By-me: termoregulacija



02951.B

Termostat sa zaslonom osjetljivim na dodir, za upravljanje funkcijama ON/OFF, PWM i PID, za sustave sa 2 i 4 cijevi, ventilokonvektor sa 3 brzine i proporcionalni, 1 ulaz za senzor NTC - 2 modula. Dubina: 38,5 mm



02951.BN

Termostat sa zaslonom osjetljivim na dodir, za upravljanje funkcijama ON/OFF, PWM i PID, za sustave sa 2 i 4 cijevi, ventilokonvektor sa 3 brzine i proporcionalni, 1 ulaz za senzor NTC - 2 modula. Dubina: 38,5 mm



14432

Elektronički senzor temperature. Dubina: 23,4 mm



14433

Elektronički senzor vlage 12/24 V, 1 izlaz 0-10 V ili 4-20 mA - 2 modula. Dubina: 36 mm



14538

Elektronička sonda za upravljanje funkcijama ON/OFF, PWM, PID i točku kondenzacije, za sustave sa 2/4 cijevi, komanda ventilokonvektora sa 3 brzine i proporcionalnog, 1 ulaz za senzor temperature. Dubina: 39 mm



14432.SL

Elektronički senzor temperature. Dubina: 23,4 mm



14433.SL

Elektronički senzor vlage 12/24 V, 1 izlaz 0-10 V ili 4-20 mA - 2 modula. Dubina: 36 mm



14538.SL

Elektronička sonda za upravljanje funkcijama ON/OFF, PWM, PID i točku kondenzacije, za sustave sa 2/4 cijevi, komanda ventilokonvektora sa 3 brzine i proporcionalnog, 1 ulaz za senzor temperature. Dubina: 39 mm



02965.1

Senzor temperature žice, NTC 10 kΩ, 3 metra



01546

Postaja za očitavanje metereoloških podataka, standard KNX, 12-32 Vdc ili 12-24 Vac



01465

Klimatski regulator za toplinska postrojenja, 120-230 V~ 50/60 Hz, 3 ulaza za sonde PT100, PT1000 i NTC, 1 izlaz komande miješnog ventila, 1 izlaz 0-10 V ili (0)4-20 mA, 1 preklopni relejni izlaz 8 A 230 V~, 6 modula x 17,5 mm

Bijelo

Silver

By-me: upravljanje energijom



14537

Aktivator s relejnim izlazom 16 A 120-230 V~ 50/60 Hz s ugrađenim strujnim senzorom - 2 modula.
Dubina: 36 mm



14537.SL

Aktivator s relejnim izlazom 16 A 120-230 V~ 50/60 Hz s ugrađenim strujnim senzorom - 2 modula.
Dubina: 36 mm



01451

Mjerač energije s ugrađenim strujnim senzorom, mogućnost detektiranja snage do 3680 W, ugradbena instalacija (stražnji trup spojnice)



01452

Sučelje brojača impulsa za očitavanje podataka iz uređaja koji posjeduju impulsni izlaz kao što su brojlja energije, vode, plina, ugradbena instalacija (stražnji trup spojnice)



01457

Senzor toroidalne struje za kontrolu opterećenja i mjerač energije, promjer otvora 7,5 mm, duljina kabela 40 cm



01458

Senzor toroidalne struje za kontrolu opterećenja i mjerač energije, promjer otvora 19 mm, duljina kabela 40 cm



01459

Senzor diferencijalne toroidalne struje za kontrolu opterećenja i mjerač energije, promjer otvora 9 mm, duljina kabela 40 cm



01450

Mjerač energije, 3 ulaza za senzor toroidalne struje, 25 W-100 kW, 120-230 V 50/60 Hz, 230/400 V 50/60 Hz, 1 modula x 17,5 mm. Opremljeno senzorom toroidalne struje 01457



01455

Modul za kontrolu opterećenja, 3 ulaza za senzor toroidalne struje, 25 W-100 kW, 120-230 V 50/60 Hz, 230/400 V 50/60 Hz, 1 modula x 17,5 mm. Opremljeno senzorom toroidalne struje 01457



01456

Aktivator s relejnim izlazom 16 A 120-230 V~ 50/60 Hz za senzor diferencijalne toroidalne struje, 1 modula x 17,5 mm

Bijelo

Silver

Well-contact Plus: nadgledanje



21848.1.B
Dodirni zaslon u boji 4,3", Full Flat, za kontrolu i upravljanje, 1 ulaz za senzor temperature, opremljen nosačem za instalaciju u kutije 8 modula. Dubina: 40 mm



21849.1.B
Dodirni zaslon u boji za kontrolu i upravljanje, 1 ulaz za senzor temperature - 3 modula. Dubina: 37 mm



21848.1.BN
Dodirni zaslon u boji 4,3", Full Flat, za kontrolu i upravljanje, 1 ulaz za senzor temperature, opremljen nosačem za instalaciju u kutije 8 modula. Dubina: 40 mm



21849.1.BN
Dodirni zaslon u boji za kontrolu i upravljanje, 1 ulaz za senzor temperature - 3 modula. Dubina: 37 mm



Softver za upravljanje sustavom Well-contact Plus

01589: Well-contact Suite Light

01590: Well-contact Suite Basic

01591: Well-contact Suite Top

01592: Well-contact Suite Client

01593: Well-contact Suite Office

01594: Well-contact Suite Client Office

01595

Dodatni softver za sučeljavanje sa softverima za upravljanje



01597

Zamjenski USB stick za softver Well-contact Suite



01993

Hardversko sučelje za programiranje zaslona osjetljivih na dodir Well-contact Plus. Potreban je softver za konfiguraciju zaslona osjetljivih na dodir



01514
Sučelje s 2 kanala koji se mogu programirati kao ulazi ili izlazi za LED, standard KNX



01515
Sučelje s 4 kanala koji se mogu programirati kao ulazi ili izlazi za LED, standard KNX



01510
Uređaj s 4 digitalna ulaza koji se mogu programirati za kontakte NO, NC, 120-230 V~, standard KNX, 2 modula x 17,5 mm



01522
Uređaj za ulaz/izlaz, 4 relejna izlaza NO 16 A 250 V~, 4 ulaza za kontakte NO, standard KNX, 4 modula x 17,5 mm



01523
Aktivator s 4 relejna izlaza NO 16 A 250 V~, standard KNX, 4 modula x 17,5 mm



01524
Aktivator za 2 roletne s relejnim izlazima 16 A 250 V~, standard KNX, 4 modula x 17,5 mm



01521
Aktivator sa 12 relejnih izlaza za fluorescentne svjetiljke od 10 A 250 V~ 50/60 Hz, standard KNX, 12 modula x 17,5 mm



01525
Aktivator za 8 roleta s relejnim izlazom od 6 A 230 V~ 50/60 Hz, standard KNX, 8 modula x 17,5 mm



01535
Aktivator za elektroventile, 6 izlaza 230 V~ 0,5 A, gumbi za lokalnu komandu, standard KNX, 4 modula x 17,5 mm



01536
Aktivator s 4 analogna izlaza 0-10 V ili (0)4-20 mA, standard KNX, 4 modula x 17,5 mm



01526
Regulator 230 V~ 50/60 Hz za žarulje 2x300 W, feromagnetski transformatori 2x300 VA, elektronski transformatori 2x300 VA, standard KNX, 4 modula x 17,5 mm



01528
Regulator osvjetljenja, 2 ulaza za 01530, 2 relejna izlaza NO 16 A 250 V~, 2 izlaza 1-10 V, standard KNX, 4 modula x 17,5 mm



01547.1
Sučelje IP, KNX, 2 modula x 17,5 mm



01542
Sučelje KNX DALI, 4 modula x 17,5 mm



01544
Poveznik DALI KNX, 8 kanala za 16 svjetiljki po kanalu, 6 modula x 17,5 mm



01540
Sučelje USB, tip B KNX, 2 modula x 17,5 mm



01545
Web poslužitelj za lokalno i daljinsko nadgledanje sustava KNX, 8 modula x 17,5 mm



Bijelo

Silver

Well-contact Plus: nadgledanje



01500.2
Napajač s izlazom Bus 30 Vdc 320 mA, napajanje 120-240 V~ 50/60 Hz, s bobinom za rastavljanje, standard KNX, 4 modula x 17,5 mm



01501.2
Napajač s izlazom Bus 30 Vdc 640 mA, dodatni izlaz 30 Vdc, napajanje 120-240 V~ 50/60 Hz, s bobinom za rastavljanje, standard KNX, 4 modula x 17,5 mm



01831
Napajač s izlazom 12 Vdc 1250 mA, napajanje 100-240 V~ 50/60 Hz, 1,5 modula x 17,5 mm



01504.2
Sprežnik linije, standard KNX, 2 modula x 17,5 mm



16887
Sigurnosni transformator, 230/12-24 V~ (SELV), 24 VA, 3 modula x 17,5 mm



01890.E
Kabel za KNX sustav, 2x2x0,8 mm, s oblogom od materijala LSZH, klasa CPR Eca, adekvatna pentru instalarea cu cabluri de Categoria I (U0 = 400 V), zelena - 100 m



▲01890.C
Kabel za KNX sustav, 2x2x0,8 mm, s oblogom od materijala LSZH, klasa Cca s1b d1 a1 Eca, adekvatna pentru instalarea cu cabluri de Categoria I (U0 = 400 V), zelena - 100 m

Well-contact Plus: kontrola i funkcije



▲01580
4 gumba
- 2 modula.
Dubina: 20 mm



▲01581
4 gumba+ aktivator releja NO 16 A 120-240 V~ 50/60 Hz
- 2 modula
Dubina: 37 mm



▲01582
4 gumba + aktivator 1 rolete s usmjeravanjem lamela, relejni izlaz za motor cosφ 0,6 2 A 120-240 V~ 50/60 Hz
- 2 modula
Dubina: 37 mm



▲01585
6 gumba
- 3 modula.
Dubina: 20 mm



▲01586
6 gumba+ aktivator releja NO 16 A 120-240 V~ 50/60 Hz
- 3 modula
Dubina: 37 mm



▲01587
6 gumba + aktivator 1 rolete s usmjeravanjem lamela, relejni izlaz za motor cosφ 0,6 2 A 120-240 V~ 50/60 Hz
- 3 modula
Dubina: 37 mm

2 međusobno zamjenjive polutipke s 1 i 2 modula



▲14751
Neutralne, uz mogućnost personalizacije



▲14751.0
Fiksne, neutralne



▲14751.1
Simboli ON/OFF



▲14751.2
Simboli strelice



▲14751.3
Simboli regulacije



▲14751.SL
Neutralne, uz mogućnost personalizacije



▲14751.0.SL
Fiksne, neutralne



▲14751.1.SL
Simboli ON/OFF



▲14751.2.SL
Simboli strelice



▲14751.3.SL
Simboli regulacije



▲14752
Neutralne, uz mogućnost personalizacije



▲14752.1
Simboli ON/OFF



▲14752.2
Simboli strelice



▲14752.3
Simboli regulacije



▲14752.SL
Neutralne, uz mogućnost personalizacije



▲14752.1.SL
Simboli ON/OFF



▲14752.2.SL
Simboli strelice



▲14752.3.SL
Simboli regulacije

Bijelo

Silver

Well-contact Plus: termoregulacija



02952.B
Elektronički termostat osjetljiv na dodir za upravljanje temperaturom u prostorijama sa 2 nezavisne zone, standard KNX, 1 relejni izlaz NO 4 A 24 V~, 1 ulaz za senzor temperature 14432 ili 02965.1, 1 digitalni ulaz s mogućnošću programiranja - 2 modula. Dubina: 37 mm



14432
Elektronički senzor temperature. Dubina: 23,4 mm



02952.BN
Elektronički termostat osjetljiv na dodir za upravljanje temperaturom u prostorijama sa 2 nezavisne zone, standard KNX, 1 relejni izlaz NO 4 A 24 V~, 1 ulaz za senzor temperature 14432 ili 02965.1, 1 digitalni ulaz s mogućnošću programiranja - 2 modula. Dubina: 37 mm



14432.SL
Elektronički senzor temperature. Dubina: 23,4 mm



14850
Detektor prisutstva na osnovu pasivnih infracrvenih zraka, standard KNX - 2 modula. Dubina: 19 mm



00802
Orijentabilni podložak - 2 modula



00805
Adaptor za podžbuknu montažu za orijentabilne podloške - 2 modula. Dubina: 36,5 mm



00800
Okvir za nadžbuknu montažu za orijentabilne podloške



14850.SL
Detektor prisutstva na osnovu pasivnih infracrvenih zraka, standard KNX - 2 modula. Dubina: 19 mm



00802.20
Orijentabilni podložak - 2 modula



00805.20
Adaptor za podžbuknu montažu za orijentabilne podloške - 2 modula. Dubina: 36,5 mm



00800.20
Okvir za nadžbuknu montažu za orijentabilne podloške



02965.1
Senzor temperature žice, NTC 10 k Ω , 3 metra



01546
Postaja za očitavanje metereoloških podataka, standard KNX, 12-32 Vdc ili 12-24 Vac



01527
Detektor sa senzorom prisutnosti na infracrvene zrake s krugom djelovanja od 360°, za paljenje svjetala ON/OFF i stalnu regulaciju osvjetljenja, grijanja, klimatizacije, ventilacije u funkciji svjetline i/ili pomicanja, polje osvijetljenosti s mogućnošću regulacije u rasponu od 1-1000 luxa, standard KNX, stropna ugradnja. Dimenzije: 80x80x45 mm



01527.S
Adapter za stropnu ugradnju detektora 01527



01529.1
Detektor sa senzorom prisutnosti na infracrvene zrake s krugom djelovanja od 360°, za paljenje svjetala ON/OFF u funkciji svjetline i/ili pomicanja, polje osvijetljenosti s mogućnošću regulacije u rasponu od 1-1000 luxa, standard KNX, stropna ugradnja. Dimenzije: 91x91x45 mm



01529.1.S
Adapter za stropnu ugradnju detektora 01529.1



01530
Senzor osvjetljenja za regulator 01528, standard KNX stropna instalacija

Bijelo

Silver

Well-contact Plus: kontrola pristupa



14457

Transponder čitač za instalaciju izvan sobe, standard KNX, 2 relejna izlaza NO 4 A 24 V~, 2 ulaza, 12-24 V~ 50/60 Hz i 12-24 Vdc (SELV) - 3 modula.

Dostavlja se bez transponder kartica

14457.TR

Kao gore, tropikaliziran. Dubina: 36 mm



14453

Transponder čitač s okomitim pretincem za instalaciju unutar sobe, standard KNX, 2 relejna izlaza - NO 4 A 24 V~, 2 ulaza, 12-24 V~ 50/60 Hz i 12-24 Vdc (SELV) - 3 modula.

Dubina: 36 mm



14457.SL

Transponder čitač za instalaciju izvan sobe, standard KNX, 2 relejna izlaza NO 4 A 24 V~, 2 ulaza, 12-24 V~ 50/60 Hz i 12-24 Vdc (SELV) - 3 modula.

Dostavlja se bez transponder kartica

14457.TR.SL

Kao gore, tropikaliziran. Dubina: 36 mm



14453.SL

Transponder čitač s okomitim pretincem za instalaciju unutar sobe, standard KNX, 2 relejna izlaza - NO 4 A 24 V~, 2 ulaza, 12-24 V~ 50/60 Hz i 12-24 Vdc (SELV) - 3 modula.

Dubina: 36 mm

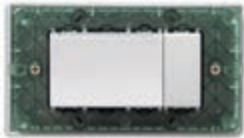

14450

Čitač/programer transponder kartica u stolnoj kutiji 4 modula



14450.SL

Čitač/programer transponder kartica u stolnoj kutiji 4 modula



01598

Transponder kartica koja se može programirati i personalizirati

Uređaji



02080.AB
Komunikacijski modul,
antibakterijske obrade



02081.AB
Modul displeja s jednostrukom
bazom, antibakterijske obrade



02082.AB
Modul zvučnika s jednostrukom
bazom, antibakterijske obrade

Uređaji za kompletiranje



02085
Izmjenjiva 8-kontaktna
vijčana stezaljka

Uređaji za kompletiranje



02075.AB
Pozivna tipkovnica s pozadinskim
osvjetljenjem, 2 komande za
svjetlo, 2 komande za pomoćne
usluge, funkcija zaštite od davljenja,
antibakterijska obrada



14505.AB
Relejni modul s utičnicom RJ45 za
pozivnu tipkovnicu s 2 svjetla + 2 AUX,
priključak prema modulu 8IN/8OUT ili
zaslonu Call-way, 4 relejna izlaza 24 V
NO, antibakterijska obrada - 3 modula.
Dubina: 29,5 mm



02089.AB
Tipkovnica za pozive s
2 komande za svjetlo,
zaštita od davljenja,
antibakterijske obrade



02086
Jednostavna
mini-tipkovnica



02087
Mini-tipkovnica s
kontrolnom lampicom



02088
Mini-tipkovnica s
2 kontrolne lampice

Zaslon



02097.1
Zaslon sustava, zidna ugradnja



02098
Nosač zaslona



02079
Ethernetsko sučelje/RS485,
9 modula x 17,5 mm

Specijalna tipkala



14501.AB
Tipkalo poziva za NO i NC
kontakte, antibakterijske
obrade - 2 modula.
Dubina: 36 mm



14502
Tipkalo poziva za
NO-krugove i 7-kon-
taktnu DIN-priključnicu
- 2 modula.
Dubina: 37 mm



14503.AB
Potezno tipkalo poziva za
NO i NC krugove, antibak-
terijske obrade - 2 modula.
Dubina: 36 mm



14504.AB
Anulacijsko tipkalo za NO krug
sa zvučnim signalom, anti-
bakterijske obrade - 2 modula.
Dubina: 36 mm

Prizmatične indikatorske jedinice - 2 modula*



14387.B
230 V~ 3 W max,
Bijeli.
Dubina: 24 mm



14387.R
230 V~ 3 W max,
Crveni.
Dubina: 24 mm



14387.V
230 V~ 3 W max,
Zeleni.
Dubina: 24 mm

Svjetiljka izvan vrata



02084
LED svjetiljka izvan vrata, četiri boje,
zidna ugradnja

* Za cjevaste žaruljice 14770, 14771, 14776 i 14777

Call-way: bolnički sustav

Pribor i elementi za šinsku instalaciju DIN (60715 TH35)



02090.2
Napojna jedinica,
24 Vdc 5 A, 100-
240 V~ 50/60 Hz



02094
Linijski sprežnik s upravljanjem
ethernetom i zvukom,
9 modula x 17,5 mm



02078
Uređaj za spajanje telefonskih poziva,
9 modula x 17,5 mm



02095
Serijsko sučelje ESPA 4.4.4,
9 modula x 17,5 mm



02096
Ploča s 8 ulaza 8 izlaza,
8 modula x 17,5 mm

Kabel



03061.E
Kabel kat. 5e F/UTP, oklopljeni, 4 upletene
parice, 24 AWG, s omotačem LSZH, klasa CPR
Eca, adekvatna za instalaciju sa kabelima de
Categorija I (U0 = 400 V), sivi - 305 m



03076.E
Kabel kat. 6 F/UTP, oklopljeni, 4 upletene
parice, 23 AWG, s omotačem LSZH, klasa CPR
Eca, adekvatna za instalaciju sa kabelima de
Categorija I (U0 = 400 V), zelena - 500 m



03086.E
Kabel kat. 6A S/FTP, oklopljeni, 4 upletene
parice, 23 AWG, s omotačem LSZH, klasa CPR
Eca, adekvatna za instalaciju sa kabelima de
Categorija I (U0 = 400 V), narančasta - 500 m

Sklopke - Antibakterijske obrade**



14041.AB
Slijepi
poklopac.
Dubina:
10 mm



14001.AB
1P obične
sklopke,
16 AX 250 V~.
Dubina: 24 mm



14015.AB
2P obične
sklopke,
16 AX 250 V~.
Dubina: 24 mm



14013.AB
1P križne
sklopke,
16 AX 250 V~.
Dubina: 24 mm



14005.AB
1P obične
sklopke,
16 AX 250 V~.
Dubina: 24 mm



14008.AB
1P NO tipkala,
10 A 250 V~.
Dubina: 24 mm



14022.AB
Zamjenjive tipke 2
modula, bez simbol



14052.AB
1P specijalna
tipkala, NO 10 A
250 V~, potezno.
Dubina: 24 mm



14136.AB.1
Regulatori MASTER,
univerzalna,
s potenciometrom.
Dubina: 40,5 mm

Priključnice - Antibakterijske obrade**



14203.AB
Utičnica SICURY
2P+T 16 A 250 V~,
talijanski standard
P17/11.
Dubina: 24 mm



14210.AB
Utičnica SICURY
2P+T 16 A 250 V~,
univerzalna
- 2 modula.
Dubina: 25 mm



14208.AB
Utičnica SICURY
2P+T 16 A 250 V~,
njemački standard
- 2 modula.
Dubina: 28,4 mm



14212.AB
Utičnica SICURY
2P+T 16 A 250 V~,
francuski standard
- 2 modula.
Dubina: 25,4 mm



14203.AB.R
Utičnica SICURY
2P+T 16 A 250 V~,
talijanski standard,
tip P17/11, crvena.
Dubina: 24 mm



14210.AB.A
Utičnica SICURY
2P+T 16 A 250 V~,
univerzalna, naran-
časta - 2 modula.
Dubina: 25 mm



14210.AB.R
Utičnica SICURY
2P+T 16 A 250 V~,
univerzalna, crvena
- 2 modula.
Dubina: 25 mm



14210.AB.V
Utičnica SICURY
2P+T 16 A 250 V~,
univerzalna, zelena
- 2 modula.
Dubina: 25 mm



14290.AB
Utičnica za aparate za brljanje
s izolacijskim transformatorom
20 VA, izlaz 230 V~ e 120 V~
- 3 modula.
Dubina: 41 mm



14330.AB
Utičnica 2P 6 A
24 V (SELV), za
utikač 01620.
Dubina: 24 mm



14320.AB
Utičnica RJ11,
6 položaja/
4 kontakata (6/4).
Dubina: 32,6 mm



14339.AB.13
Utičnica RJ45
s konektorom
Netsafe Cat. 6,
UTP.
Dubina: 29,3 mm



14339.AB.14
Utičnica RJ45
s konektorom
Netsafe Cat. 6,
FTP.
Dubina: 29,3 mm



14342.AB
RJ45 priključnice,
8 položaja/
8 kontakata (8/8).
Dubina: 32,6 mm



14300.AB.01
Koaksijalna utičnica
TV-RD-SAT 5-2400 MHz,
izravna 1 dB.
Dubina: 21,6 mm

Pribor

Signalne jedinice LED



00935.A: 12-24 V~ 0,1 W, zagasito žuta
 00935.G: 12-24 V~ 0,1 W, zelena
 00935.R: 12-24 V~ 0,1 W, crvena
 00935.B: 12-24 V~ 0,1 W, plava
 00935.W: 12-24 V~ 0,1 W, bijela

00936.250.A: 250 V~ 50/60 Hz 0,35 W, zagasito žuta
 00936.250.G: 250 V~ 50/60 Hz 0,35 W, zelena
 00936.250.R: 250 V~ 50/60 Hz 0,35 W, crvena
 00936.250.B: 250 V~ 50/60 Hz 0,35 W, plava
 00936.250.W: 250 V~ 50/60 Hz 0,35 W, bijela

00936.120.A: 120 V~ 50/60 Hz 0,2 W, zagasito žuta
 00936.120.G: 120 V~ 50/60 Hz 0,2 W, zelena
 00936.120.R: 120 V~ 50/60 Hz 0,2 W, crvena
 00936.120.B: 120 V~ 50/60 Hz 0,2 W, plava
 00936.120.W: 120 V~ 50/60 Hz 0,2 W, bijela

Ožičene signalne jedinice za sklopke



00931
 110-250 V~ 0,5 W,
 zagasito žuta



00930
 250 V~ 0,3 W, crvena,
 prikladna za utičnice
 prema britanskom
 standardu

Svjetiljke E10 10x28 mm



Neonska:
14779
 230 V~ 0,5 W, crvena¹



žarna nit:
14771
 24 V~ 3 W, bijela¹
14777
 230 V~ 3 W, bijela¹

Prozirni poklopci za nosače



14602.C
 Za nosače 2 modula



21613.C
 Za nosače 3 modula



21618.C
 Za nosače 8 (4+4) modula

Adaptori za šinsku instalaciju DIN (60715 TH35)



V51921
 Nosač 1 modula



V51922
 Nosač 2 modula



V51923
 Nosač 3 modula

¹ Odnosi se na boju svjetla

PLANA



Pokrovne ploče

Metal

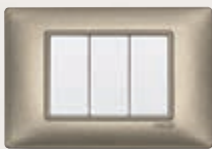

70 Metalik brončano



71 Metalik srebrno



72 Metalik zeleno



73 Metalik plavo



74 Biserno nikal

Drvo



61 Javor



62 Kruškino drvo



63 Trešnja

Plastika



01 Bijelo



02 Slonova kost



03 Bež



04 Krema



05 Crno



25 Matirano zlatno



31 Jasen



32 Jela



33 Makoré

Reflex



40 Reflex pepeljastosiva



41 Reflex sniježno-bijela

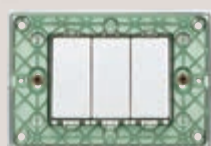

42 Reflex prozima



43 Reflex jantarno-žuta



44 Reflex menta-zelena



51 Reflex rubin-crvena



75.01 Biserno srebreno



76 Antikni mesing



81 Četkani aluminij



06 Granit bijelo



20 Matirano srebreno



21 Matirano nikal



22 Matirano šampanj



23 Svjetlucavo smeđe



24 Polirano zlatno



45 Reflex vodenasto-plava



46 Reflex cedar-žuta



47 Reflex smaragdno-zelena



48 Reflex narančasta



49 Reflex duhan-smeđa



50 Reflex safirno-plava

Napomena:

Razlike u granulaciji, boji i jednakosti površine pokrovnih ploča napravljenih od masivnog drva, njihova su vrijedna osobina i garancija su autentičnosti materijala.

Standardne pokrovne maske prema britanskom standardu

Metalizirani tehnopolimer

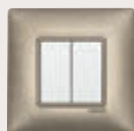

70 Metalik brončano



71 Metalik srebrno



72 Metalik zeleno



73 Metalik plavo

Plastika



01 Bijelo



02 Slonova kost



03 Bež



04 Krema



05 Crno

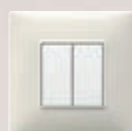

06 Granit bijelo



20 Matirano srebrno



21 Matirano nikal



22 Matirano šampanj



23 Svjetlacavo smeđe

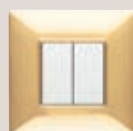

24 Polirano zlatno

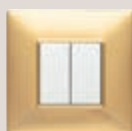

25 Matirano zlatno



31 Jasen



32 Jela



33 Makoré

Reflex



40 Reflex pepeljastosiva



41 Reflex sniježno-bijela



42 Reflex prozirna



43 Reflex jantarno-žuta



44 Reflex menta-zelena



45 Reflex vodenasto-plava



46 Reflex cedar-žuta



47 Reflex smaragdno-zelena



48 Reflex narančasta

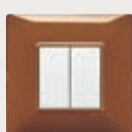

49 Reflex duhan-smeđa



50 Reflex safirno-plava



51 Reflex rubin-crvena

Standardne pokrovne maske prema njemačkom i francuskom standardu

Metalizirani tehнопolimer



26 Metalik brončano



27 Metalik srebreno

Plastika



01 Bijelo



02 Slonova kost



03 Bež



04 Krema



05 Crno



06 Granit bijelo



20 Matirano srebreno



21 Matirano nikal



22 Matirano šampanj



23 Svjetlucavo smeđe

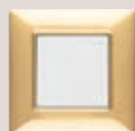

24 Polirano zlatno



25 Matirano zlatno

Reflex



40 Reflex pepeljastosiva



41 Reflex snježno-bijela



42 Reflex prozirna



43 Reflex jantarno-žuta



44 Reflex menta-zelena



45 Reflex vodenasto-plava



46 Reflex cedar-žuta



47 Reflex smaragdno-zelena



48 Reflex narančasta



49 Reflex duhan-smeđa















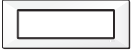





























50 Reflex safirno-plava





51 Reflex rubin-crvena

Smjernice za pokrovne maske

	1 modul	2 modula	2 središnja modula	3 modula	4 modula	7 modula	
							
Metal							
	Metalik brončano	14641.70	14642.70	14652.70	14653.70	14654.70	14657.70
	Metalik srebrno	14641.71	14642.71	14652.71	14653.71	14654.71	14657.71
	Metalik zeleno	14641.72	14642.72	14652.72	14653.72	14654.72	14657.72
	Metalik plavo	14641.73	14642.73	14652.73	14653.73	14654.73	14657.73
	Biserno nikal	14641.74	14642.74	14652.74	14653.74	14654.74	14657.74
	Biserno srebrno	14641.75.01	14642.75.01	14652.75.01	14653.75.01	14654.75.01	14657.75.01
	Antikni mesing	-	14642.76	-	14653.76	14654.76	14657.76
	Četkani aluminij	14641.81	14642.81	14652.81	14653.81	14654.81	14657.81
Drvo							
	Javor	14641.61	14642.61	-	14653.61	14654.61	14657.61
	Kruškino drvo	14641.62	14642.62	-	14653.62	14654.62	14657.62
	Trešnja	14641.63	14642.63	-	14653.63	14654.63	14657.63
Plastika							
	Bijelo**	14641.01	14642.01-14642.AB.01	14652.01	14653.01-14653.AB.01	14654.01-14654.AB.01	14657.01-14657.AB.01
	Slonova kost	14641.02	14642.02	14652.02	14653.02	14654.02	14657.02
	Bež	14641.03	14642.03	14652.03	14653.03	14654.03	14657.03
	Krema	14641.04	14642.04	14652.04	14653.04	14654.04	14657.04
	Crno	14641.05	14642.05	14652.05	14653.05	14654.05	14657.05
	Granit bijelo	14641.06	14642.06	14652.06	14653.06	14654.06	14657.06
	Matirano srebrno	14641.20	14642.20	14652.20	14653.20	14654.20	14657.20
	Matirano nikal	14641.21	14642.21	14652.21	14653.21	14654.21	14657.21
	Matirano šampanj	14641.22	14642.22	14652.22	14653.22	14654.22	14657.22
	Svjetlucavo smeđe	14641.23	14642.23	14652.23	14653.23	14654.23	14657.23
	Polirano zlatno	14641.24	14642.24	14652.24	14653.24	14654.24	14657.24
	Matirano zlatno	14641.25	14642.25	14652.25	14653.25	14654.25	14657.25
	Jasen	14641.31	14642.31	14652.31	14653.31	14654.31	14657.31
	Jela	14641.32	14642.32	14652.32	14653.32	14654.32	14657.32
	Makoré	14641.33	14642.33	14652.33	14653.33	14654.33	14657.33
Reflex							
	Reflex pepeljastosiva	14641.40	14642.40	14652.40	14653.40	14654.40	14657.40
	Reflex sniježno-bijela	14641.41	14642.41	14652.41	14653.41	14654.41	14657.41
	Reflex prozirna	14641.42	14642.42	14652.42	14653.42	14654.42	14657.42
	Reflex jantarno-žuta	14641.43	14642.43	14652.43	14653.43	14654.43	14657.43
	Reflex menta-zelena	14641.44	14642.44	14652.44	14653.44	14654.44	14657.44
	Reflex vodenasto-plava	14641.45	14642.45	14652.45	14653.45	14654.45	14657.45
	Reflex cedar-žuta	14641.46	14642.46	14652.46	14653.46	14654.46	14657.46
	Reflex smaragdno-zelena	14641.47	14642.47	14652.47	14653.47	14654.47	14657.47
	Reflex narančasta	14641.48	14642.48	14652.48	14653.48	14654.48	14657.48
	Reflex duhan-smeđa	14641.49	14642.49	14652.49	14653.49	14654.49	14657.49
	Reflex safirno-plava	14641.50	14642.50	14652.50	14653.50	14654.50	14657.50
	Reflex rubin-crvena	14641.51	14642.51	14652.51	14653.51	14654.51	14657.51

** .AB: antibakterijske obrade

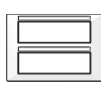
Smjernice za pokrovne maske





8 modula	6 modula	14 modula	21 modula	Za panelsku montažu 1 modul	Za panelsku montažu 2 modula
					
14668.70*	-	-	-	-	-
14668.71*	-	-	-	-	-
14668.72*	-	-	-	-	-
14668.73*	-	-	-	-	-
14668.74*	-	-	-	-	-
14668.75.01*	-	-	-	-	-
-	-	-	-	-	-
-	-	-	-	-	-
-	-	-	-	-	-
14668.01	14659.01	14690.01	14691.01	14666.01	14667.01
14668.02	14659.02	14690.02	14691.02	14666.02	14667.02
14668.03	14659.03	-	-	-	-
14668.04	14659.04	-	-	-	-
14668.05	14659.05	14690.05	14691.05	14666.05	14667.05
14668.06	14659.06	-	-	-	-
14668.20	-	14690.20	14691.20	14666.20	14667.20
14668.21	-	14690.21	14691.21	14666.21	14667.21
14668.22	-	-	-	-	-
14668.23	-	-	-	-	-
14668.24	-	-	-	-	-
14668.25	-	-	-	-	-
14668.31	-	-	-	-	-
14668.32	-	-	-	-	-
14668.33	-	-	-	-	-
14668.40	-	-	-	-	-
14668.41	-	-	-	-	-
14668.42	-	-	-	-	-
14668.43	-	-	-	-	-
14668.44	-	-	-	-	-
14668.45	-	-	-	-	-
14668.46	-	-	-	-	-
14668.47	-	-	-	-	-
14668.48	-	-	-	-	-
14668.49	-	-	-	-	-
14668.50	-	-	-	-	-
14668.51	-	-	-	-	-

Standardne pokrovne maske prema britanskom standardu: vodič za izbor















	2 modula	3 modula/u jednom komadu	5 modula/u jednom komadu
--	----------	--------------------------	--------------------------















Metalizirani tehnopolimer

	Metalik brončano	14647.70	14648.70	14649.70
	Metalik srebreno	14647.71	14648.71	14649.71
	Metalik zeleno	14647.72	14648.72	14649.72
	Metalik plavo	14647.73	14648.73	14649.73







Plastika



























	Bijelo	14647.01	14648.01	14649.01
	Slonova kost	14647.02	14648.02	14649.02
	Bež	14647.03	14648.03	14649.03
	Krema	14647.04	14648.04	14649.04
	Crno	14647.05	14648.05	14649.05
	Granit bijelo	14647.06	14648.06	14649.06
	Matirano srebreno	14647.20	14648.20	14649.20
	Matirano nikal	14647.21	14648.21	14649.21
	Matirano šampanj	14647.22	14648.22	14649.22
	Svjetlucavo smeđe	14647.23	14648.23	14649.23
	Polirano zlatno	14647.24	14648.24	14649.24
	Matirano zlatno	14647.25	14648.25	14649.25
	Jasen	14647.31	14648.31	14649.31
	Jela	14647.32	14648.32	14649.32
	Makoré	14647.33	14648.33	14649.33



































Reflex

	Reflex pepeljastosiva	14647.40	14648.40	14649.40
	Reflex sniježno-bijela	14647.41	14648.41	14649.41
	Reflex prozima	14647.42	14648.42	14649.42
	Reflex jantarno-žuta	14647.43	14648.43	14649.43
	Reflex menta-zelena	14647.44	14648.44	14649.44
	Reflex vodenasto-plava	14647.45	14648.45	14649.45
	Reflex cedar-žuta	14647.46	14648.46	14649.46
	Reflex smaragdno-zelena	14647.47	14648.47	14649.47
	Reflex narančasta	14647.48	14648.48	14649.48
	Reflex duhan-smeđa	14647.49	14648.49	14649.49
	Reflex safirno-plava	14647.50	14648.50	14649.50
	Reflex rubin-crvena	14647.51	14648.51	14649.51



















Standardne pokrovne maske prema njemačkom i francuskom standardu: vodič za izbor

	2 modula	2+2 modula (razmak između centara 71 mm)	2+2+2 modula (razmak između centara 71 mm)	2+2+2+2 modula (razmak između centara 71 mm)	2+2 modula (razmak između centara 57 mm)	2+2+2 modula (razmak između centara 57 mm)
						

Metalizirani tehnopolimer						
	Metalik brončano	14642.26	14643.26	14644.26	14669.26	-
	Metalik srebrno	14642.27	14643.27	14644.27	14669.27	-
Plastika						
	Bijelo**	14642.01-14642.AB.01	14643.01-14643.AB.01	14644.01-14644.AB.01	14669.01-14669.AB.01	14645.01 14646.01
	Slonova kost	14642.02	14643.02	14644.02	14669.02	14645.02 14646.02
	Bež	14642.03	14643.03	14644.03	14669.03	14645.03 14646.03
	Krema	14642.04	14643.04	14644.04	14669.04	14645.04 14646.04
	Crno	14642.05	14643.05	14644.05	14669.05	14645.05 14646.05
	Granit bijelo	14642.06	14643.06	14644.06	14669.06	14645.06 14646.06
	Matirano srebrno	14642.20	14643.20	14644.20	14669.20	14645.20 14646.20
	Matirano nikal	14642.21	14643.21	14644.21	14669.21	14645.21 14646.21
	Matirano šampanj	14642.22	14643.22	14644.22	14669.22	14645.22 14646.22
	Svjetlacavo smeđe	14642.23	14643.23	14644.23	14669.23	14645.23 14646.23
	Polirano zlatno	14642.24	14643.24	14644.24	14669.24	14645.24 14646.24
	Matirano zlatno	14642.25	14643.25	14644.25	14669.25	14645.25 14646.25
Reflex						
	Reflex pepeljastosiva	14642.40	14643.40	14644.40	14669.40	-
	Reflex sniježno-bijela	14642.41	14643.41	14644.41	14669.41	-
	Reflex prozirna	14642.42	14643.42	14644.42	14669.42	-
	Reflex jantarno-žuta	14642.43	14643.43	14644.43	14669.43	-
	Reflex menta-zelena	14642.44	14643.44	14644.44	14669.44	-
	Reflex vodenasto-plava	14642.45	14643.45	14644.45	14669.45	-
	Reflex cedar-žuta	14642.46	14643.46	14644.46	14669.46	-
	Reflex smaragdno-zelena	14642.47	14643.47	14644.47	14669.47	-
	Reflex narančasta	14642.48	14643.48	14644.48	14669.48	-
	Reflex duhan-smeđa	14642.49	14643.49	14644.49	14669.49	-
	Reflex safirno-plava	14642.50	14643.50	14644.50	14669.50	-
	Reflex rubin-crvena	14642.51	14643.51	14644.51	14669.51	-











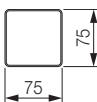



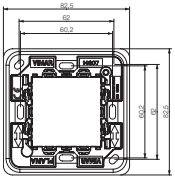

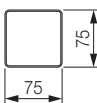
Modul	Prilog	Okvir	Ploče*	
1 i 2 modula za prilog ø 60 mm	<p>Podžbukna montaža</p>  <p>V71001 GW 650 °C, svijetlo plavo V71001.AU GW 960 °C, crno</p>  <p>V71701 Za šuplje zidove, s vijcima, GW 850 °C, svijetlo plavo</p>	<p>Nadžbukna montaža</p>  <p>09971.A Sužena 43,5 mm, bjelokost RAL 9001 09971.01: bijelo</p>  <p>09972.01 Sužena 30 mm, bijelo</p>	  <p>14601 1 modul, s kucicama 14601.G Kao gore, sivo</p> <p>14600 1 modul, bez vijaka 14600.G Kao gore, sivo</p>     <p>14602 2 modula, s kucicama 14602.G Kao gore, sivo</p> <p>14603 2 modula, bez vijaka 14603.G Kao gore, sivo</p> <p>14604 2 modula, s kucicama</p> <p>14605 2 modula, bez vijaka</p>	 <p>14641... 1 modul Dimenzije: 80x80x9 mm</p>   <p>14642... 2 modula Dimenzije: 80x80x9 mm</p> <p>14642.C.01 2 modula, s poklopcem, bijelo Dimenzije: 80x80x14 mm</p>
	<p>2 središnji moduli</p>  <p>V71001 GW 650 °C, svijetlo plavo V71001.AU GW 960 °C, crno</p>  <p>V71701 Za šuplje zidove, s vijcima, GW 850 °C, svijetlo plavo</p>   <p>V71303 GW 650 °C, svijetlo plavo V71303.AU GW 960 °C, crno</p> <p>V71703 Za šuplje zidove, GW 850 °C, svijetlo plavo</p>  <p>09971.A Sužena 43,5 mm, bjelokost RAL 9001 09971.01: bijelo</p>  <p>09972.01 Sužena 30 mm, bijelo</p>  <p>09975.A Sužena 43,5 mm, bjelokost RAL 9001 09975.01: bijelo</p>     <p>14602 2 modula, s kucicama 14602.G Kao gore, sivo</p> <p>14603 2 modula, bez vijaka 14603.G Kao gore, sivo</p> <p>14604 2 modula, s kucicama</p> <p>14605 2 modula, bez vijaka</p>  <p>14612 2 središnja modula, s vijcima</p>	  <p>14652... 2 središnja modula, horizontalna vertikalna instalacija Dimenzije: 119,5x80x9 mm</p>		
3	<p>Podžbukna montaža</p>   <p>V71303 GW 650 °C, svijetlo plavo V71303.AU GW 960 °C, crno</p> <p>V71703 Za šuplje zidove, GW 850 °C, svijetlo plavo</p> <p>09975.A Sužena 43,5 mm, bjelokost RAL 9001 09975.01: bijelo</p>	<p>Nadžbukna montaža</p>  <p>09975.A Sužena 43,5 mm, bjelokost RAL 9001 09975.01: bijelo</p>	 <p>14613 3 modula, s vijcima 14613.G Kao gore, sivo</p>	 <p>14653... 3 modula Dimenzije: 119,5x80x9 mm</p>
	 <p>V54303 Podna kupola s 3 modula (nadopuniti kutijom V54903)</p>  <p>V54903 Ugradbena kutija za podnu kupolu (nadopuniti kupolom V54303)</p>			

Vrste ugradnje

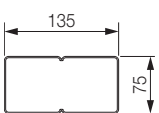
Modul	Prilog	Okvir	Ploče*	
4	<p>Podžbukna montaža</p>  <p>V71304 GW 650 °C, svijetlo plavo V71304.AU GW 960 °C, crno</p> <p>V71704 Za šuplje zidove, GW 850 °C, svijetlo plavo</p>	<p>Stolnu montažu</p>  <p>14784 4 modula, bijelo 14784.SL: Silver</p>	 <p>19614 4 modula, s vijcima</p>	 <p>14654... 4 modula Dimenzije: 142x80x9 mm</p>
7	<p>Podžbukna montaža</p>  <p>V71306 GW 650 °C, svijetlo plavo V71306.AU GW 960 °C, crno</p> <p>V71706 Za šuplje zidove, GW 850 °C, svijetlo plavo</p>	<p>Stolnu montažu</p>  <p>14787 7 modula, bijelo 14787.SL: Silver</p>	 <p>14617 7 modula, s vijcima</p>	 <p>14657... 7 modula Dimenzije: 206x80x9 mm</p>
8 (4+4)	<p>Podžbukna montaža</p>  <p>V71318 GW 650 °C, svijetlo plavo</p> <p>V71718 Za šuplje zidove, GW 850 °C, svijetlo plavo</p>	<p>Stolnu montažu</p>  <p>14788 8 modula, bijelo 14788.SL: Silver Dimenzije: 142,2x150,3x134 mm</p>	 <p>21554... Video zaslon osjetljiv na dodir 4,3" Full Flat</p>  <p>21511.1... Ekran osjetljiv na dodir 4,3" Full Flat, s ugrađenim montažnim okvirom za 8 modula</p> <p>21848.1... Ekran osjetljiv na dodir 4,3" Full Flat Well-contact Plus, s ugrađenim montažnim okvirom za 8 modula</p>  <p>14618 8 modula (4+4), s vijcima</p>	 <p>14668... 8 modula Dimenzije: 142,5x151x9 mm</p>  <p>14668... 8 modula Dimenzije: 142,5x151x9 mm</p>
6 (3+3)	<p>Podžbukna montaža</p>  <p>09996 GW 650 °C, svijetlo plavo 09996.AU GW 960 °C, crno</p>		 <p>14619 6 modula (3+3) 4x4", s vijcima</p>	 <p>14659... 6 modula Dimenzije: 120x132x11 mm</p>

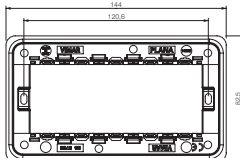
Modul	Prilog	Okvir	Ploče*
14 (7+7)	Podžbukna montaža V71320 GW 650 °C, svijetlo plavo V71720 Za šuplje zidove, GW 850 °C, svijetlo plavo	Nadžbukna montaža 09920.01 , bijelo	 14620... 14 modula (7+7), s vijcima 14690... 14-modula (7+7) Dimenzije: 206x148x11 mm
21 (7+7+7)	Podžbukna montaža V71321 GW 650 °C, svijetlo plavo Nadžbukna montaža 09921.01 , bijelo	 14621 21 modula (7+7+7), s vijcima	 14691... 21 modula (7+7+7) Dimenzije: 206x222x11 mm
1	Za panelnu montažu 16776.AU GW 960 °C	 14626 1 modul, s vijcima	 14666... 1 modul Dimenzije: 40x80x9 mm
2	Za panelnu montažu 16776.AU x 2 GW 960 °C	 14627 2 modula, s vijcima	 14667... 2 modula Dimenzije: 40x137x9 mm
1 i 2 modula za prilog Ø 60 mm i Ø 65 mm 	 14601 1 modul, s kukicama 14601.G Kao gore, sivo 14600 1 modul, bez vijaka 14600.G Kao gore, sivo	 14641... 1 modul Dimenzije: 80x80x9 mm	
	 14602 2 modula, s kukicama 14602.G Kao gore, sivo 14603 2 modula, bez vijaka 14603.G Kao gore, sivo 14604 2 modula, s kukicama 14605 2 modula, bez vijaka	 14642... 2 modula Dimenzije: 80x80x9 mm 14642.C.01 2 modula, s poklopcem, bijelo Dimenzije: 80x80x14 mm	
	 14602 2 modula, s kukicama 14602.G Kao gore, sivo 14603 2 modula, bez vijaka 14603.G Kao gore, sivo 14604 2 modula, s kukicama 14605 2 modula, bez vijaka	 14652... 2 središnja modula Dimenzije: 119,5x80x9 mm	

Ugradnja prema britanskom standardu

Modul	Prilog	Okvir/Uređaji	Ploče*
1 i 2	<p>Podžbukna montaža</p>  <p>Ugradna kutija 1 modul. Međuosni razmak: 60,3 mm</p>	 <p>14606¹ 1 modul, s vijcima M 3,5, bijelo</p>  <p>14606.SL¹ 1 modul, s vijcima M 3,5, Silver</p>  <p>14607¹ 2 modula, s vijcima M 3,5</p> 	 <p>14647¹... 2 modula Dimenzije: 95x95x9 mm</p>
3 modula u jednom komadu	<p>Podžbukna montaža</p>  <p>Ugradna kutija 1 modul. Međuosni razmak: 60,3 mm</p>	 <p>14608¹ 3 modula, s vijcima M 3,5</p>  <p>14215 Primjer vodoravne ugradnje u jednom komadu</p>  <p>14017 Primjer okomite ugradnje u jednom komadu</p>	 <p>14648¹... 3 modula. Za vodoravnu i okomitu ugradnju. Dimenzije: 95x95x9 mm</p>
5 modula u jednom komadu	<p>Podžbukna montaža</p>  <p>Ugradna kutija 2 modula. Međuosni razmak: 120,6 mm</p>	 <p>14609¹ 5 modula, s vijcima M 3,5</p>   <p>14222 Primjer vodoravne ugradnje u jednom komadu</p>  <p>14291 Primjer okomite ugradnje u jednom komadu</p>	 <p>14649¹... 5 modula. Za vodoravnu i okomitu ugradnju. Dimenzije: 155x95x9 mm</p>

Instalacija s međuosnim razmakom od 71 mm i 57 mm

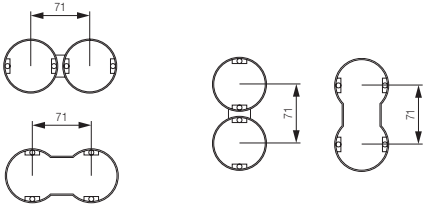
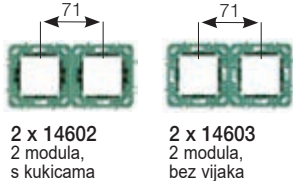
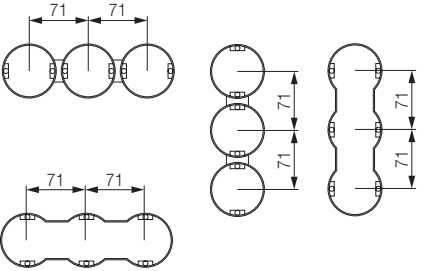
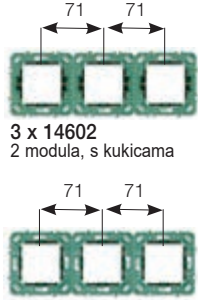
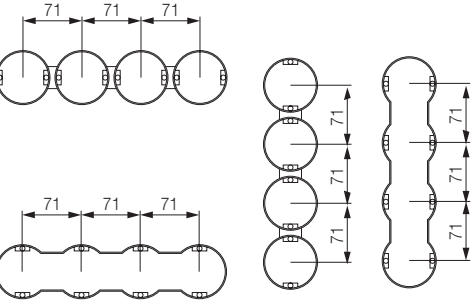
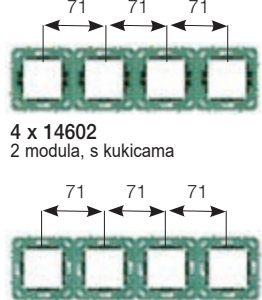
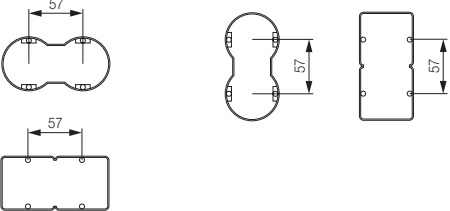
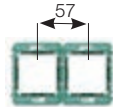
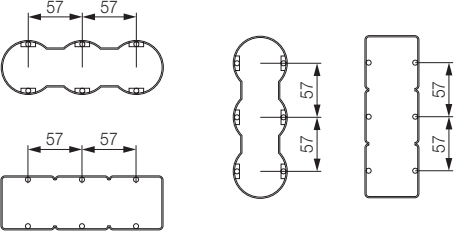
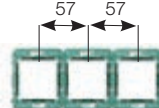
Modul	Prilog	Okvir
<p>2+2 modula Međuosni razmak 71 mm</p>		 <p>2 x 14602 2 modula, s kukicama</p> <p>2 x 14603 2 modula, bez vijaka</p>
<p>2+2+2 modula Međuosni razmak 71 mm</p>		 <p>3 x 14602 2 modula, s kukicama</p> <p>3 x 14603 2 modula, bez vijaka</p>
<p>2+2+2+2 modula Međuosni razmak 71 mm</p>		 <p>4 x 14602 2 modula, s kukicama</p> <p>4 x 14603 2 modula, bez vijaka</p>
<p>2+2 modula Međuosni razmak 57 mm</p>		 <p>2 x 14605 2 modula, bez vijaka</p>
<p>2+2+2 modula Međuosni razmak 57 mm</p>		 <p>3 x 14605 2 modula, bez vijaka</p>

Instalacija s međuosnim razmakom od 71 mm i 57 mm

		Ploče*
		 <p>14643... 4 (2+2) modula, horizontalna i okomita montaža. Dimenzije: 150,5x80x9 mm</p>
		 <p>14644... 6 (2+2+2) modula, horizontalna i okomita montaža. Dimenzije: 221,5x80x9 mm</p>
		 <p>14669... 8 (2+2+2+2) modula, horizontalna i okomita montaža. Dimenzije: 293x80x9 mm</p>
 <p>2 x 14604 2 modula, s kukicama</p>  <p>2 x 14605 2 modula, bez vijaka</p>		 <p>14645... 4 (2+2) modula, horizontalna i okomita montaža. Dimenzije: 136,5 x80x9 mm</p>
 <p>3 x 14604 2 modula, s kukicama</p>  <p>3 x 14605 2 modula, bez vijaka</p>		 <p>14646... 6 (2+2+2) modula, horizontalna i okomita montaža. Dimenzije: 193,5x80x9 mm</p>

Personalizacija

Personalizacija elemenata i pokrovnih ploča

VIMAROVA laserska tehnologija omogućuje reprodukciju bilo kojeg imena, logotipa ili oznake, uz apsolutnu preciznost i neizbrisivost, pa i kad se radi o sasvim malim količinama.

Naznake za personalizaciju

- moguće je personalizirati sve komande, tipke i pokrovne maske s ovdje opisanim modalitetima i položajima;
- u slučaju **Plana Silver** moguće je personalizirati jedino ove tipke: **14021.G.SL**, **14022.G.SL** i **14023.G.SL**;
- naredne pokrovne ploče u boji ne mogu se personalizirati: **Svjetlacavo smeđe (23)**, **Polirano zlatno (24)**, **Matirano zlatno (25)**, **Jasen (31)**, **Jela (32)**, **Makoré (33)**, **Antikni mesing (76)**;
- personalizacija drvenih pokrovnih ploča: cijene i količine ugovaraju se preko trgovačke mreže.
- kod natpisa na modulima, uvjerite se da željeni simbol ili natpis nije već uključen u gornju tabelu 'Standardni simboli i natpisi'; ako jesu, jednostavno navedite odgovarajuću šifru nastavno na šifru artikla iz vaše narudžbe;
- personalizirana izrada **vidljiva u mraku** moguća je samo na komandama i tipkama sa simbolom koji je već obuhvaćen katalogom ili na tipkama koje su međusobno zamjenjive s područjem koje se želi personalizirati (npr. 14021.G, 14022.G e 14023.G).

Prednosti laserske personalizacije

- neizbrisivo graviranje koje ne iščezava s vremenom;
- reprodukcija s visokom preciznošću i u slučaju vrlo finih linija ili kompleksnih slika;
- usluga dostupna i kod minimalnih količina;
- mogućnost naručivanja iste personalizacije u različito vrijeme uz identične rezultate.

Neka ograničenja ove tehnologije

- ne mogu se reproducirati slike u boji.

Što treba osigurati

- tiskani primjerak slike koju treba reproducirati, u crno-bijelom crtežu 2 ili 3 puta većem od željene veličine;
- sliku možete priložiti i na magnetskom mediju u EPS, TIFF ili JPEG formatu.

Što izbjegavati

- ne prilažite fotkopije;
- crtež ne šalžite faksom, jer niska rezolucija onemogućuje reprodukciju dokumenta u laser kvaliteti.

Kako nastaviti

- priložite sliku koji treba reproducirati, ne koristeći pritom metalne kvačice, spojnice ili ljepljivu traku;
- svu navedenu dokumentaciju dostavite vašem regionalnom veletrgovcu/distributeru, koji će je prosljediti Vimar;

Približno vrijeme isporuke za elemente i pokrovne ploče

- 10 radnih dana za uzorak;
- 10 radnih dana od potvrde za kompletiranje narudžbe.

Primjeri personaliziranih tipki i komandi



Primjer personalizirane pokrovne maske



Primjeri personaliziranih komandi sa svjetlećim pokazivačem



Personalizacija Smart Card

Karticu je na zahtjev moguće personalizirati sa stražnje strane, uz primjenu digitalne slike subjekta kojeg se reproducira u formatu eps, tiff ili jpg.



Personalizacija

Položaj i načini rada za tipke i komande

Plana

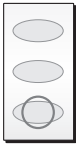

Standardna sklopka ili tipka s prstenom osvijetljivim pomoću pilot lampice. Personalizacija nije vidljiva u mraku.

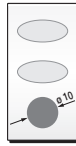

Tipka s oznakom osvijetljivom pomoću pilot lampice (14021.G, 14022.G, 14023.G). Prilagodba: nevidljivo u mraku (gornji i središnji dio), vidljivo u mraku (donji dio).

Plana Silver



Izmjenjiva tipka, može se osvijetliti (14021.G.SL, 14022.G.SL, 14023.G.SL). Dio koji se može prilagoditi: 13x8,5 mm. Prilagodba: vidljivo u mraku (donji dio).

Položaj i načini rada za pokrovne maske

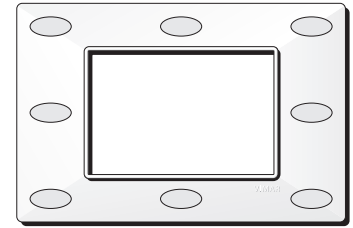

Plana i Plana Silver



Međusobno zamjenjive tipke 14751... Personalizacija pomoću lasera vidljivog u mraku gore i dolje.

Standardni simboli i natpisi (♦ simboli na elementima u katalogu)

♦ S14.001	S14.002	S14.003	S14.004	S14.005	S14.006	S14.007	S14.008	S14.009	S14.010	S14.011	S14.012	S14.013	S14.014	S14.015	S14.016	S14.017
S14.018	S14.019	S14.020	S14.021	S14.022	S14.023	S14.024	S14.025	S14.026	S14.027	S14.028	♦ S14.029	S14.030	S14.031	S14.032	S14.033	S14.034
S14.035	S14.036	S14.037	S14.038	♦ S14.039	♦ S14.040	S14.041	S14.042	S14.043	S14.044	S14.045	S14.046	S14.047	S14.048	♦ S14.049	S14.050	S14.051
S14.052	♦ S14.053	♦ S14.054	♦ S14.055	♦ S14.056	♦ S14.057	♦ S14.058	♦ S14.059	♦ S14.060	S14.061	S14.062	S14.063	S14.064	S14.065	S14.066	S14.067	S14.068
S14.069	S14.070	S14.071	S14.072	♦ S14.073	♦ S14.074	S14.075	S14.076	S14.077	S14.078	S14.079	S14.080	S14.081	S14.082	S14.083	S14.084	S14.085
S14.086	S14.087	S14.088	S14.089	S14.090	S14.091	S14.092	S14.093	S14.094	S14.095	S14.096	S14.097	S14.098	S14.099	S14.100	S14.101	S14.102
S14.103	S14.104	S14.105	S14.106	S14.107	S14.108	S14.109	S14.110	S14.111	S14.112	S14.113	S14.114	S14.115	S14.116	♦ S14.117	S14.118	S14.119
S14.120	S14.121	S14.122	S14.123	S14.124	S14.125	S14.126	S14.127	S14.128	S14.129	S14.130	S14.131	S14.132	S14.133	S14.134	S14.135	S14.136
S14.137	S14.138	S14.139	S14.140	S14.141	S14.142	S14.143	S14.144	S14.145	S14.146	S14.147	S14.148	S14.149	S14.150	S14.151	S14.152	S14.153
S14.154	S14.155	S14.156	S14.157	S14.158	S14.159	S14.160	S14.161	S14.162	S14.163	S14.164	S14.165	S14.166	S14.167	S14.168	S14.169	S14.170
S14.171	S14.172	S14.173	S14.174	S14.175	S14.176	S14.177	S14.178	S14.179	S14.180	S14.181	S14.182	S14.183	S14.184	S14.185	S14.186	S14.187
light S14.188.EN	open S14.189.EN	close S14.190.EN	alarm S14.191.EN	come in S14.192.EN	back S14.193.EN	stairs S14.194.EN	bathroom S14.195.EN	cellar S14.196.EN	storeroom S14.197.EN	attic S14.198.EN	terrace S14.199.EN	outside S14.200.EN	garden S14.201.EN	garage S14.202	general S14.203.EN	

Ugradbene kutije i pribor od stranice 106

Zidne kutije od stranice 112

Isoset: zidni spremnici IP40 i IP55 od stranice 114

Stolne kutije od stranice 118

Razvodne ugradbene kutije i pribor od stranice 119

Razvodne kutije za zidne stijene od stranice 127

Ugradbene centralne upravljačke jedinice i pribor od stranice 131

Središnje upravljačke jedinice za distribuciju podataka od stranice 135

Centralne upravljačke jedinice, zidna zaštitna kućišta i pribor od stranice 136

Ugradbene kutije

Ugradbene kutije za klasične zidove



V71001
Okrugla ø 60 mm
(GW 650 °C), nebesko plava



V71001.AU
Okrugla ø 60 mm
(GW 960 °C), crna

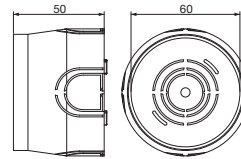

V71001, V71001.AU



V71303
(GW 650 °C), nebesko plava - 3 modula



V71303.AU
(GW 960 °C), crna - 3 modula

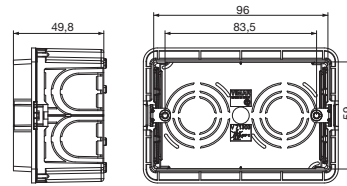

V71303, V71303.AU



V71304
(GW 650 °C), nebesko plava - 4 modula



V71304.AU
(GW 960 °C), crna - 4 modula

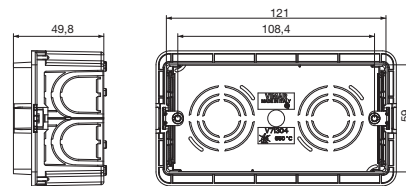

V71304, V71304.AU



V71305
(GW 650 °C), nebesko plava - 5 modula



V71305.AU
(GW 960 °C), crna - 5 modula

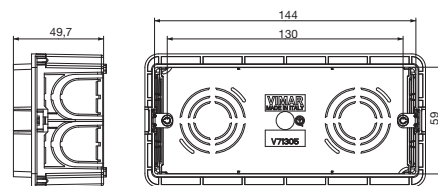

V71305, V71305.AU



Separator za izradu električki odvojenih modularnih prostora



Perforirani otvori različitih promjera na svakoj strani



Savršeno nasuprotno postavljanje kutija zahvaljujući referentnim klinovima i klinovima za blokiranje

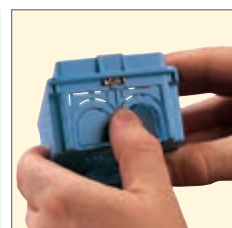

Perforirane ploče na probija-nje usidrene za tijelo kutije na samo dva mjesta

Dimenzije ulaza kabela

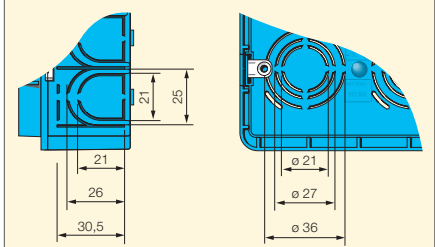

Ugradbene kutije

Ugradbene kutije za klasične zidove



V71306
(GW 650 °C), nebesko plava
- 6/7 modula



V71306.AU
(GW 960 °C), crna
- 6/7 modula

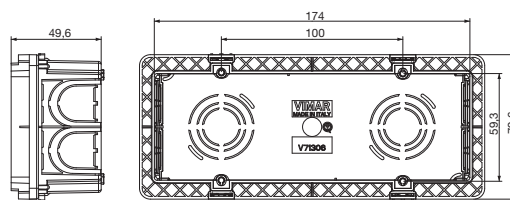

V71306, V71306.AU



09996
(GW 650 °C), nebesko plava
- 6 modula (3+3)

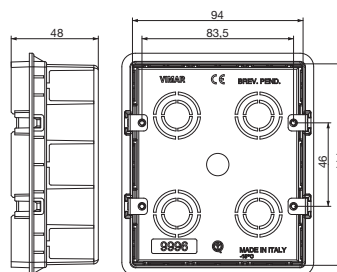

09996



V71318
(GW 650 °C), nebesko plava
- 8 modula

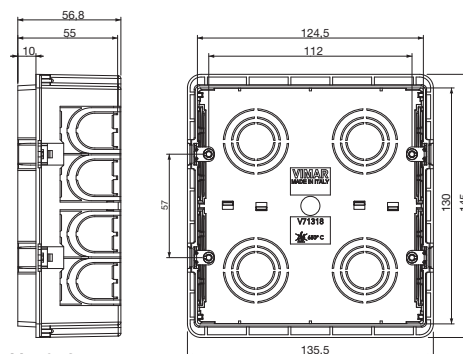

V71318



V71320
(GW 650 °C), nebesko plava
- 12/14 modula

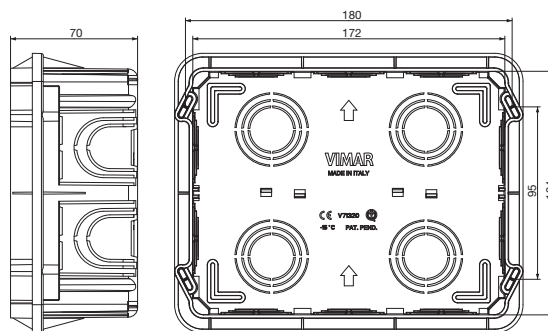

V71320

Ugradbene kutije

Ugradbene kutije za klasične zidove



V71321
(GW 650 °C), nebesko plava
- 18/21 modula

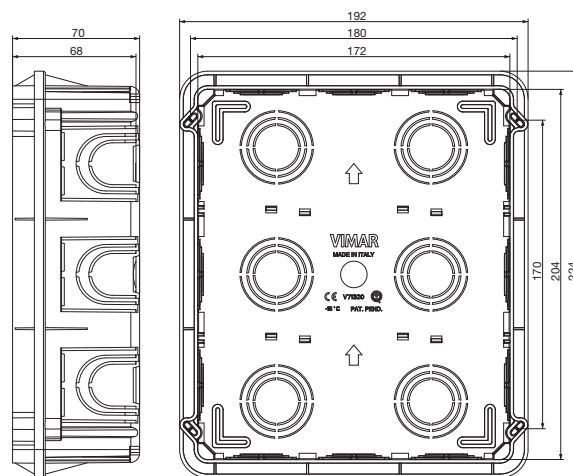

V71321

Poklopci za zaštitu od žbuke za ugradbene kutije za klasične zidove



V71011
Poklopac za kutije V71001
i V71001.AU, žuti



V71323
Poklopac za kutije V71303
i V71303.AU, žuti



V71324
Poklopac za kutije V71304
i V71304.AU, žuti



V71325
Poklopac za kutije V71305 i
V71305.AU, žuti



V71326
Poklopac za kutije V71306 i
V71306.AU, žuti



V71328
Poklopac za kutije V71318 i
V71718, žuti

Pribor za ugradbene kutije za klasične zidove



V71563
Spojnica za povezivanje za
vodoravnu i okomitu kompoziciju
ugradbenih kutija V71303,
V71304, V71305, V71306, žuta.
Duljina 58,2 mm

Baterije kutija izrađene pomoću spojnica V71563

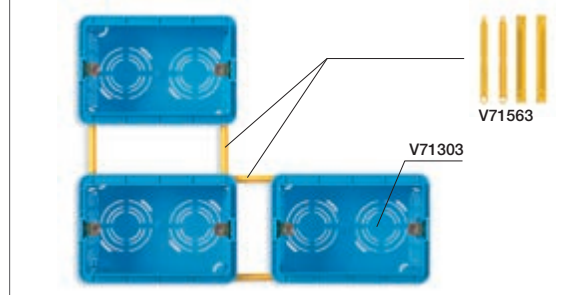

Ugradbene kutije

Ugradbene kutije za tanke zidove



V71701
Okrugla ø 60 mm (GW 850 °C),
nebesko plava, prikladna samo
za potpore bez kukice

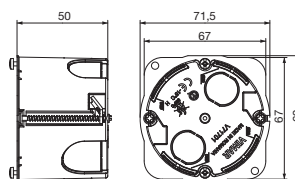

V71701



V71703
(GW 850 °C), nebesko plava
- 3 modula

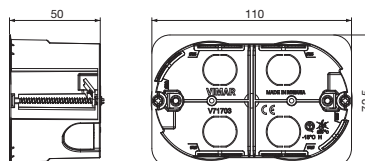

V71703



V71704
(GW 850 °C), nebesko plava
- 4 modula

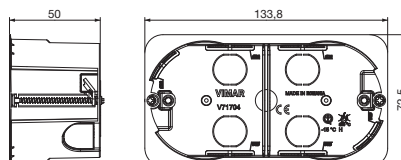

V71704

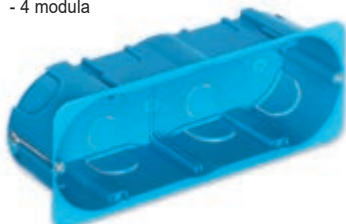

V71706
(GW 850 °C), nebesko plava
- 6/7 modula

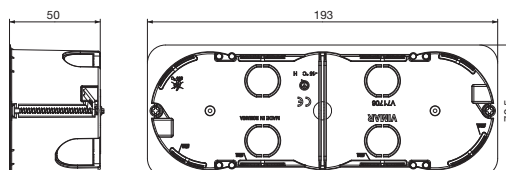

V71706



V71718
(GW 850 °C), nebesko plava
- 8 modula

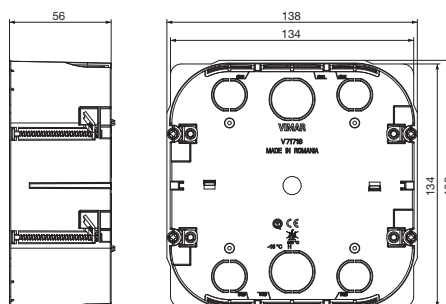

V71718

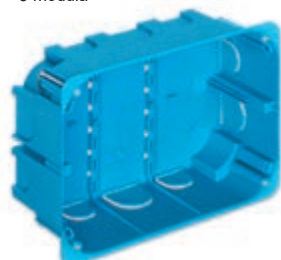

V71720
Višefunkcijska (GW 850 °C), nebesko plava.
Oмотаč za опсenitu uporabu (GP)
- 12/14 modula

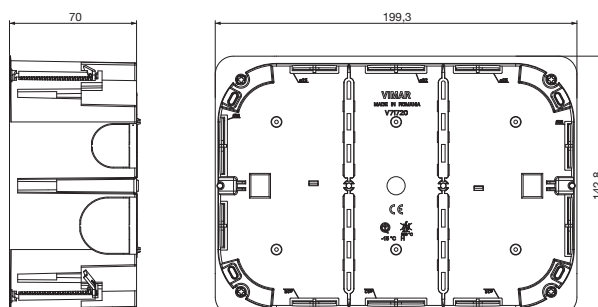

V71720

Ugradbene kutije

Višefunkcijski pribor za ugradbene kutije za tanke zidove



V71571
Potpora za postavljanje kutija V71701 s unutarnje strane zida, žuta:
• šablona za centriranje;
• spojnica za povezivanje za montiranje u vodoravnoj ili okomitoj bateriji



V71573
Potpora za postavljanje kutija V71703 s unutarnje strane zida, žuta:
• šablona za centriranje;
• spojnica za povezivanje za montiranje u vodoravnoj ili okomitoj bateriji



V71574
Potpora za postavljanje kutija V71704 s unutarnje strane zida, žuta:
• šablona za centriranje;
• spojnica za povezivanje za montiranje u vodoravnoj ili okomitoj bateriji

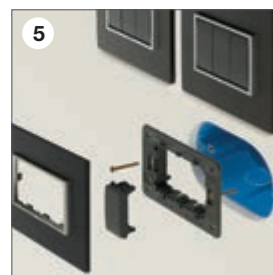
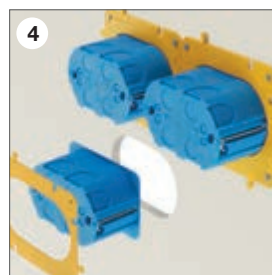
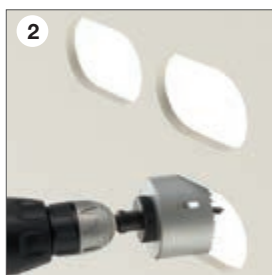

1. i 2. Upotrijebite pribor (V71573) kao šablonu za precizno bušenje.
3. Središnja rešetka uklanja se pomoću običnog rezača ili električarskim škarama. Pomagalo se prilagođava kutiji i može se upotrijebiti kao objumica.
4. Nakon što se kutija postavi na otvor, pričvrstite je s unutarnje strane tankog zida normalnim vijcima za gips-karton.
5. Rezultat je precizno pristajanje na uvlačivu zidnu stijenu.

Višefunkcijski pribor za ugradbene kutije za klasične i tanke zidove



V71550
Separator za kutije V71303..., V71304..., V71305..., V71306..., V71703, V71704, V71706, žuti



V71551
Vodoravni separator za kutije V71320, V71321, V71620, V71720, 09920..., 09921..., žuti. Omogućava izradu električki odvojenih prostora unutar kutije



V71552
Vodoravni separator za kutije V71318 i V71718, žuti. Omogućava izradu električki odvojenih prostora unutar kutije

Poklopci za ugradbene kutije za klasične i tanke zidove



02645
Okrugli \varnothing 76 mm s kukicom za kutije \varnothing 55-70 mm, urea, bijeli



02646
Okrugli \varnothing 94 mm s kukicom za kutije \varnothing 75-85 mm, urea, bijeli



02647
Kvadratni 82x82 mm s kukicom za kutije \varnothing 55-70 mm, urea, bijeli



02648
Kvadratni 101x101 mm s kukicom za kutije \varnothing 75-85 mm, urea, bijeli



02653
Pravokutni s vijcima za kutije V71303, urea, bijeli. Međuosni razmak za pričvršćivanje 83,5 mm



V71630
Pravokutni s vijcima za kutije V71320 i V71720, bijeli

Ugradbene kutije

Poklopci stopljeni sa zidom za ugradbene kutije za klasične i tanke zidove



▲V71632
Poklopac stopljen sa zidom
za kutije s 2 modula, bijeli

Način pričvršćivanja

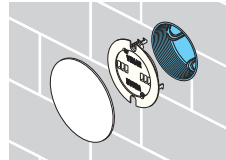

Klasični zidovi.

Pričvršćivanje nosača kutije provodi se putem kukice dok se poklopac pričvršćuje na zabravni nosač, bez vidljivih vijaka.

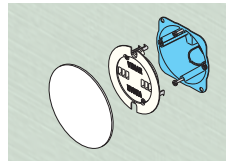

Tanki zidovi.

Pričvršćivanje nosača kutije provodi se putem vijaka dok se poklopac pričvršćuje na zabravni nosač, bez vidljivih vijaka.

Poklopci stopljeni sa zidom za ugradbene kutije za klasične i tanke zidove

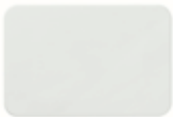

▲V71633
Poklopac stopljen sa zidom
za kutije s 3 modula, bijeli

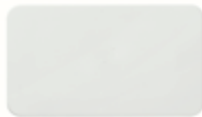

▲V71634
Poklopac stopljen sa zidom
za kutije s 4 modula, bijeli

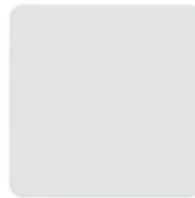

V71631
Poklopac za kutije V71318 e
V71718, pričvršćuje se uglavlji-
vanjem za poklopac s uključeno-
m zaštitom od žbuke V71328, bijeli

Poklopac stopljen sa zidom: instalacija na ugradbene kutije

Kompatibilnost.

Moguće ih je instalirati na ugradne kutije za klasične zidove i za tanke zidove.

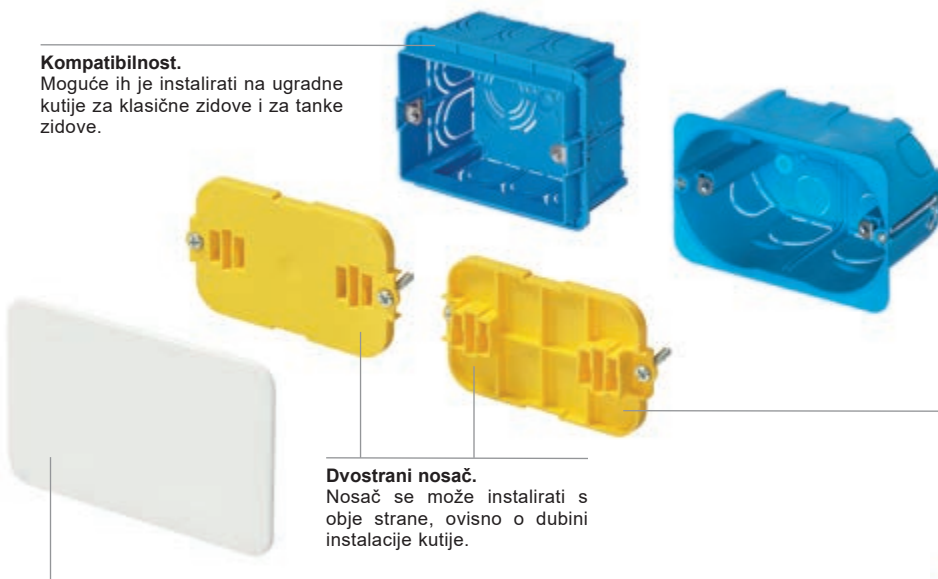

Dvostrani nosač.

Nosač se može instalirati s obje strane, ovisno o dubini instalacije kutije.

Poklopac.

Poklopac se instalira na nosač putem zabavnog sustava, jamčeći čvrstinu ugradnje i optimalne estetske rezultate, zahvaljujući odsutnosti vijaka.

Maksimalan estetski učinak.

Poklopac, zahvaljujući minimalnom izbočenju, mogućnosti lakiranja i odsutnosti nepravilnosti na površini izgleda nedodirljiv čak i ako je instaliran na potpuno vidljivo mjesto.

Instalacija sa standardnom dubinom kutije

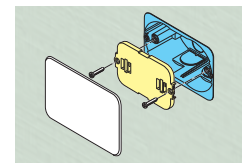
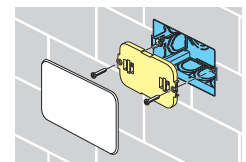

Instalacija s većom dubinom kutije

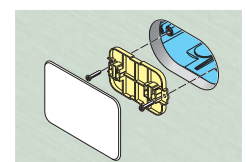
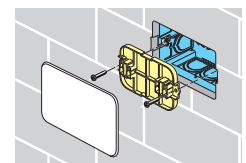

Zidne kutije

Zidne kutije



09971.A
Pravokutna za ugradnju 1 ili 2 smanjena modula Idea, boja bjelokosti RAL 9001. Prilagođena samo za pokrovnu masku Classica



09971.01
Pravokutna za ugradnju 1 ili 2 smanjena modula Idea, bijeli. Prilagođena samo za pokrovnu masku Classica

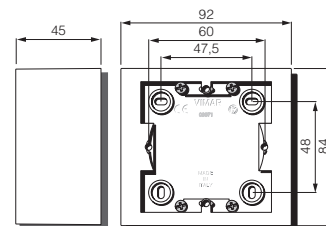

09971...



09972.01
Pravokutna za ugradnju 1 ili 2 smanjena modula Idea, bijeli

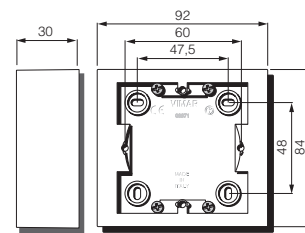

09972...



09975.A
Pravokutna za ugradnju 3 modula, boja bjelokosti RAL 9001. Prilagođena samo za pokrovnu masku Classica



09975.01
Pravokutna za ugradnju 3 modula, bijeli. Prilagođena samo za pokrovnu masku Classica

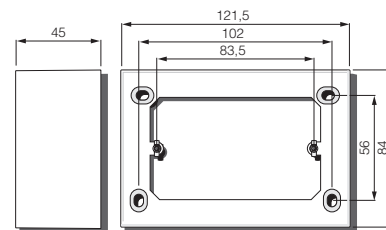

09975...



09976.04
Pravokutna za ugradnju 3 modula, bijeli Idea. Prilagođena samo za pokrovnu masku Classica



09976.14
Pravokutna za ugradnju 3 modula, siva Idea. Prilagođena samo za pokrovnu masku Classica

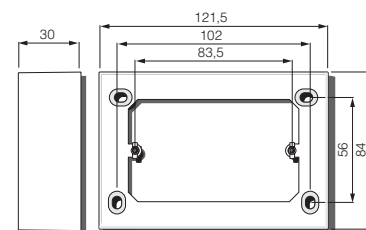

09976...



09983
Pravokutna za 3 modula, siva



09983.01
Pravokutna za 3 modula, bijeli

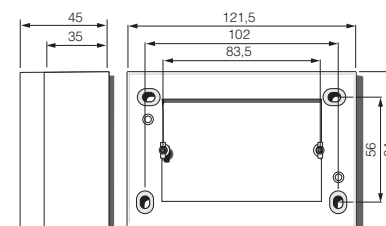

09983...

Zidne kutije

Zidne kutije



09920.01
Pravokutna za ugradnju
12 (6+6) modula, bijela

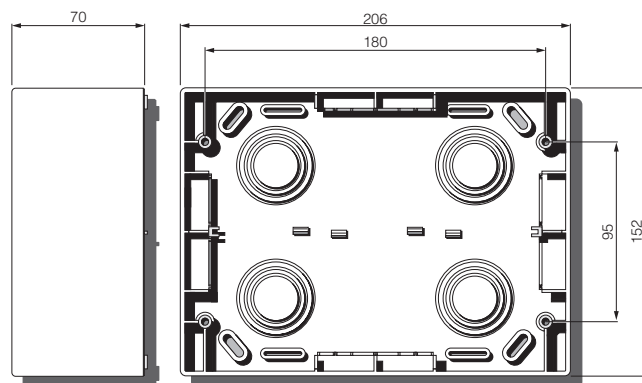

09920...



09921.01
Pravokutna za ugradnju
18 (6+6+6) modula, bijela

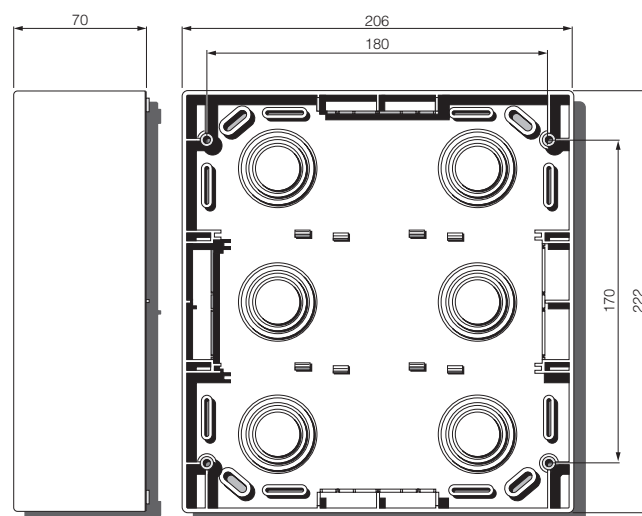

09921.01

Isoset: zidni spremnici IP40

Spremnici Isoset IP40



14801
1 modul



14802
2 modula,
aparati koje je moguće
zakvačiti vodoravno i
okomito

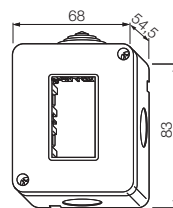

14801, 14802



14803
3 modula

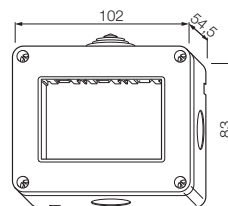

14803



14804
4 modula

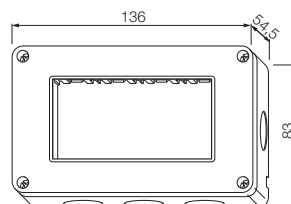

14804



14812
4 modula (2+2),
aparati koje je moguće
zakvačiti vodoravno i okomito



Kvačenje aparata na isti spremnik kako okomito tako i vodoravno.

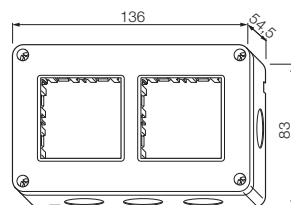

14812



14813
6 modula (2+2+2),
aparati koje je moguće
zakvačiti vodoravno i okomito

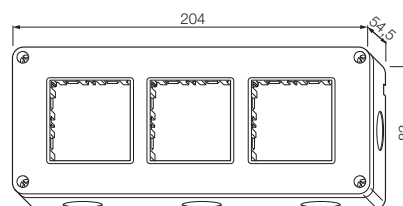

14813



14814
8 modula (2+2+2+2),
aparati koje je moguće
zakvačiti vodoravno i okomito

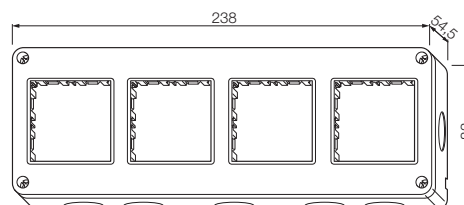

14814



14815
10 modula (2+2+2+2+2),
aparati koje je moguće
zakvačiti vodoravno i okomito

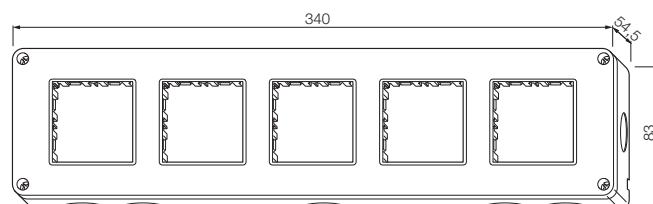

14815

Isoset: zidni spremnici IP40

Spremnici Isoset IP40



14817
14 modula (2+2+2+2+2+2+2),
aparati koje je moguće zakvačiti
vodoravno i okomito

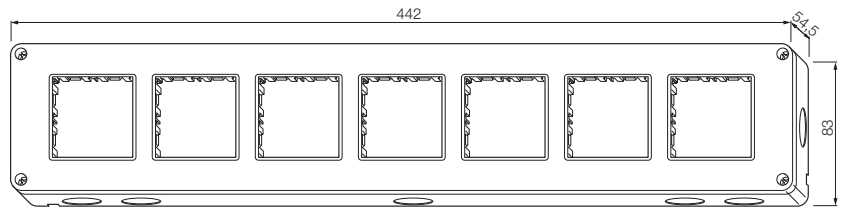

14817



14827
6 modula (3+3 u horizontali)

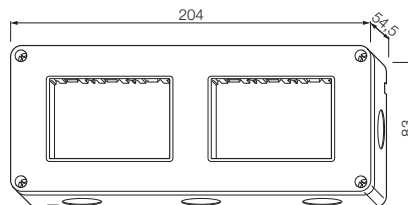

14827



14832
8 modula (4+4 u vertikalni)

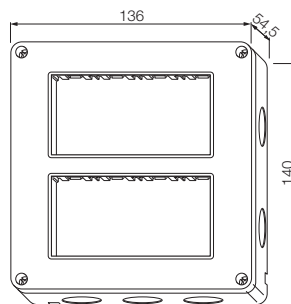

14832

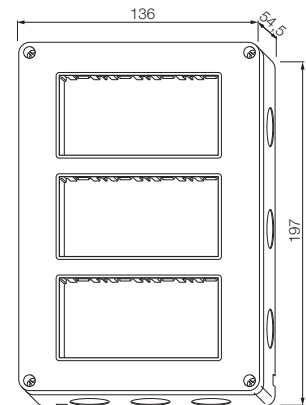

14833



14833
12 modula (4+4+4 u vertikalni)

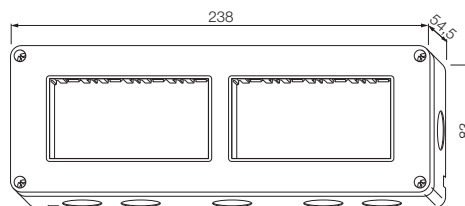

14837



14837
8 modula (4+4 u horizontali)

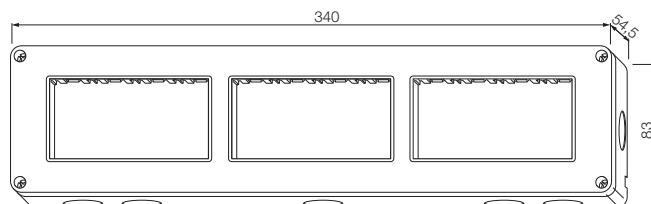

14838



14838
12 modula (4+4+4 u horizontali)

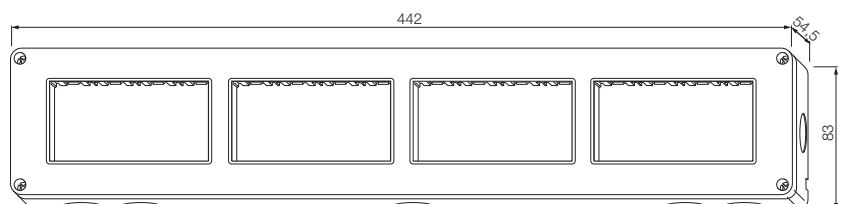

14839



14839
16 modula (4+4+4+4 u horizontali)

Isoset: zidni spremnici IP55

Spremnici Isoset IP55



14901
1 modul



14902
2 modula

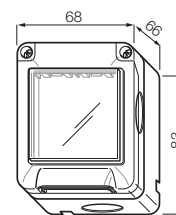

14901, 14902



14903
3 modula

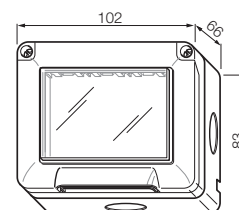

14903



14904
4 modula

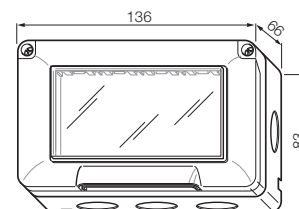

14904



14912
8 modula (4+4 u vertikalni)

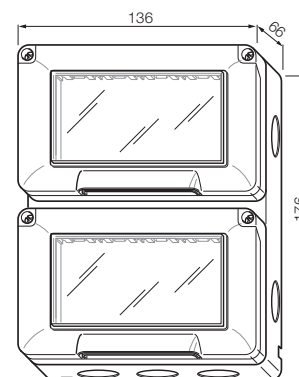

14912



14913
12 modula (4+4+4 u vertikalni)

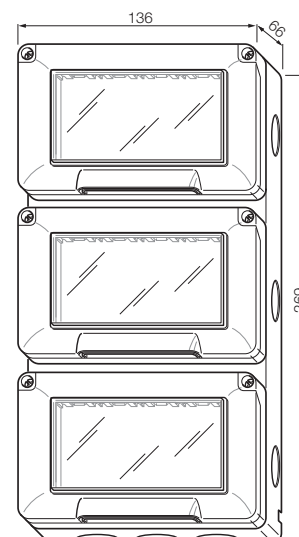

14913

Isoset: zidna kućišta IP55

Kućišta Isoset IP55



14931
s kukicom, za kutije
ø 60 mm, siva
RAL 7035
- 2 modula



14931.01
s kukicom, za kutije
ø 60 mm, bijela
- 2 modula



14931.14
s kukicom, za kutije
ø 60 mm, granitno
siva
- 2 modula

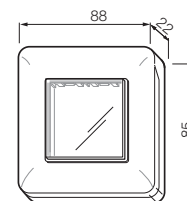

14931...



14932
s vijcima, za kutije s
međuosnim razmakom
od 60 mm, siva RAL
7035 - 2 modula



14932.01
s vijcima, za kutije s
međuosnim razmakom
od 60 mm, bijela - 2
modula



14932.14
s vijcima, za kutije s
međuosnim razma-
kom od 60 mm, gran-
itno siva - 2 modula

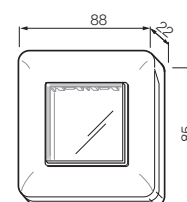

14932...



14943
s vijcima, za kutije s
3 modula,
siva RAL 7035
- 3 modula



14943.01
s vijcima, za kutije s
3 modula, bijela
- 3 modula



14943.14
s vijcima, za kutije s
3 modula,
granitno siva
- 3 modula

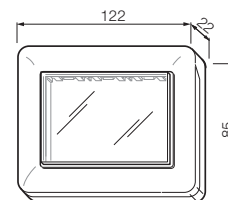

14943...



14944
s vijcima, za kutije s
4 modula,
siva RAL 7035
- 4 modula



14944.01
s vijcima, za kutije s
4 modula, bijela
- 4 modula



14944.14
s vijcima, za kutije s
4 modula, granitno
siva - 4 modula

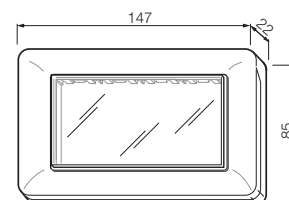

14944...

Stolne kutije

Stolne nakošene kutije koje se nadopunjavaju nosačem i pokrovnom maskom



14784
4 modula,
bijela



14784.SL
4 modula,
Silver

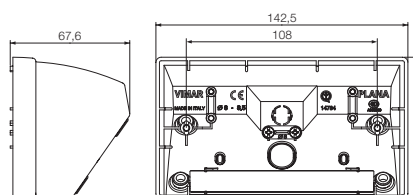

14784...



14787
7 modula,
bijela



14787.SL
7 modula,
Silver

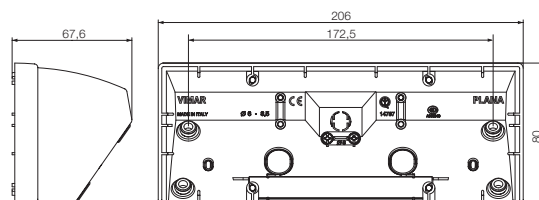

14787...

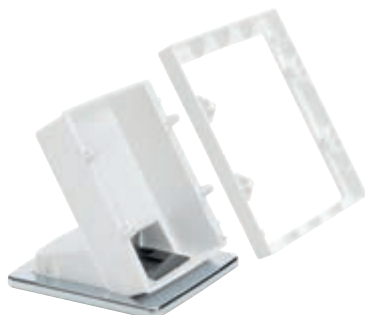

14788
Opremljena je okvirom
za pokrovnju masku s
8 modula (4+4),
bijela



14788.SL
Opremljena je okvirom
za pokrovnju masku s
8 modula (4+4),
Silver

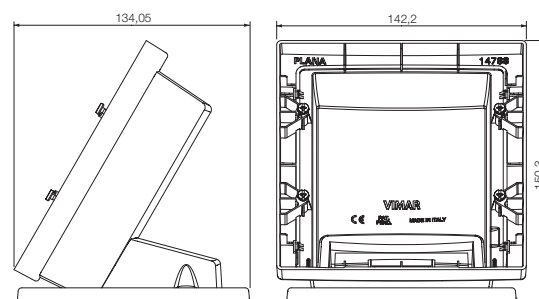

14788...

Shematski prikaz kutije u rasklopljenom stanju s 4 modula s uređajima Plana.



Razvodne ugradbene zidne kutije

Ugradbene razvodne kutije za klasične zidove



V70001

S bijelim poklopcem, poklopcem za zaštitu od žbuke i pričvrsnim vijcima. Dimenzija kutije: 92x92x50 mm

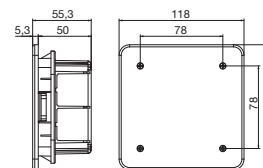

V70001



V70002

S bijelim poklopcem, poklopcem za zaštitu od žbuke i pričvrsnim vijcima. Dimenzija kutije: 116x92x50 mm

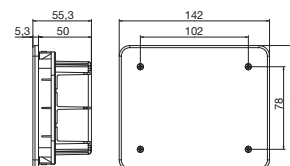

V70002



V70003

S bijelim poklopcem, poklopcem za zaštitu od žbuke i pričvrsnim vijcima. Dimenzija kutije: 116x92x70 mm

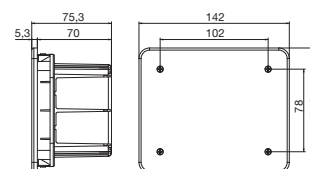

V70003



V70004

S bijelim poklopcem, poklopcem za zaštitu od žbuke i pričvrsnim vijcima. Dimenzija kutije: 154x92x70 mm

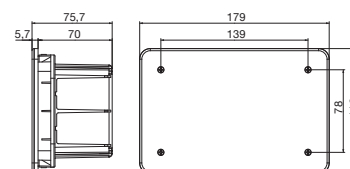

V70004



V70005

S bijelim poklopcem, poklopcem za zaštitu od žbuke i pričvrsnim vijcima. Dimenzija kutije: 154x128x70 mm

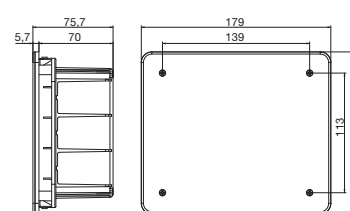

V70005



V70006

S bijelim poklopcem, poklopcem za zaštitu od žbuke i pričvrsnim vijcima. Dimenzija kutije: 195x154x70 mm
Izgubljena snaga: 13 W

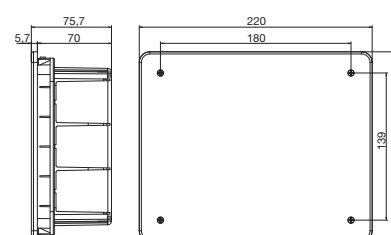

V70006

Razvodne ugradbene zidne kutije

Ugradbene razvodne kutije za klasične zidove



V70007

S bijelim poklopcem, poklopcem za zaštitu od žbuke i pričvršnim vijcima. Dimenzija kutije: 287x154x70 mm
Izgubljena snaga: 24 W

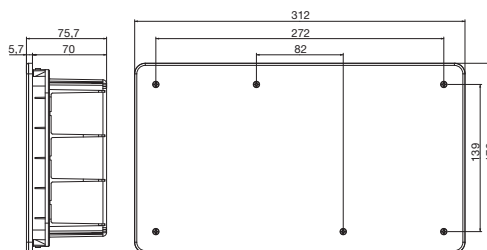

V70007



V70008

S bijelim poklopcem, poklopcem za zaštitu od žbuke i pričvršnim vijcima. Dimenzija kutije: 391x154x70 mm
Izgubljena snaga: 30 W

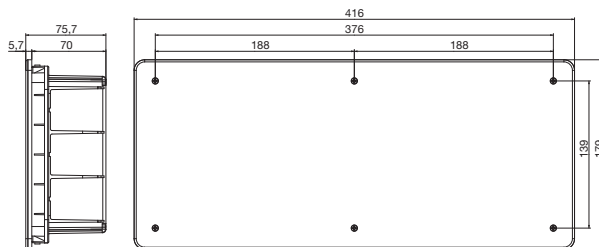

V70008



V70009

S bijelim poklopcem, poklopcem za zaštitu od žbuke i pričvršnim vijcima. Dimenzija kutije: 479x154x70 mm
Izgubljena snaga: 33 W

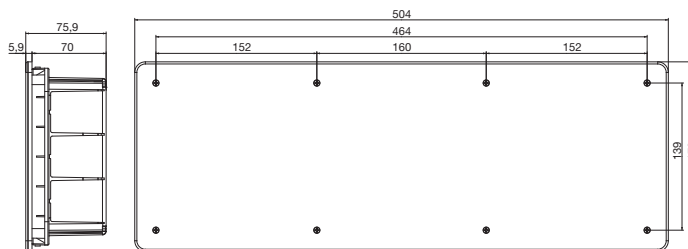

V70009



V70010

S bijelim poklopcem, poklopcem za zaštitu od žbuke i pričvršnim vijcima. Dimenzija kutije: 515x201x80 mm
Izgubljena snaga: 54 W

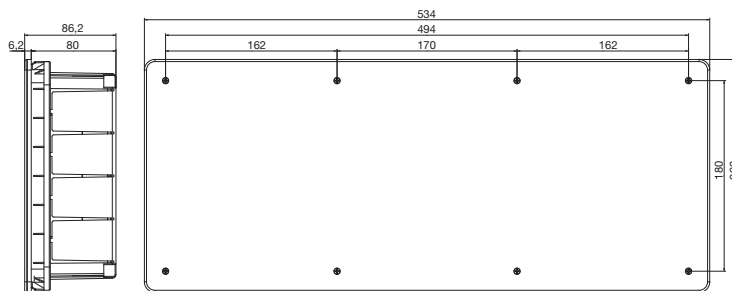

V70010

Razvodne ugradbene zidne kutije

Ugradbene razvodne kutije za klasične zidove



V70011

S bijelim poklopcem, poklopcem za zaštitu od žbuke i pričvršnim vijcima. Dimenzija kutije: 515x292x80 mm, 5 isporučenih separatora. Izgubljena snaga: 64 W

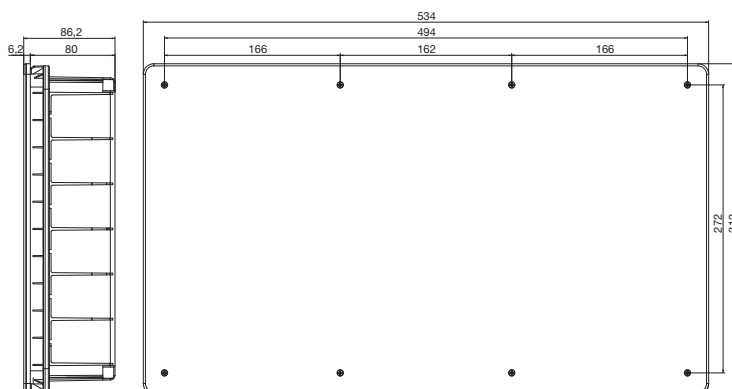

V70011



V70207

S bijelim poklopcem, poklopcem za zaštitu od žbuke i pričvršnim vijcima. Dimenzija kutije: 248x248x120 mm, 1 isporučenih separatora. Izgubljena snaga: 26 W

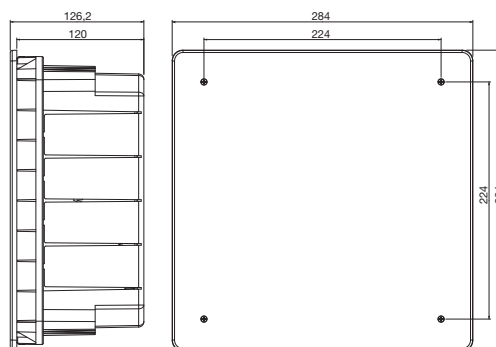

V70207



V70211

S bijelim poklopcem, poklopcem za zaštitu od žbuke i pričvršnim vijcima. Dimenzija kutije: 515x248x120 mm, 4 isporučenih separatora. Izgubljena snaga: 69 W

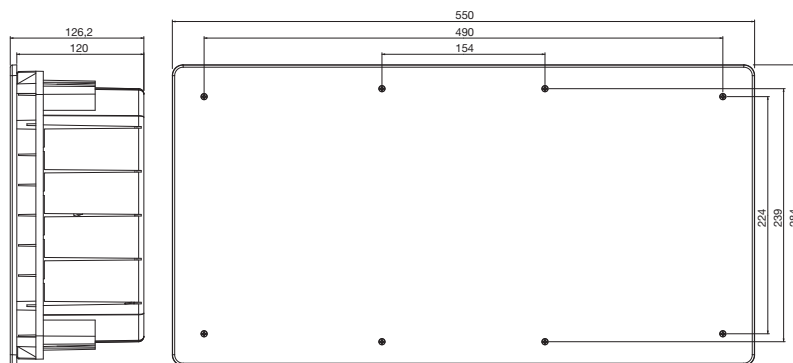

V70211

Razvodne ugradbene zidne kutije

Visokootporni poklopci 20 J za kutije za klasične zidove



V70101
Za kutiju V70001



V70102
Za kutiju V70002
i V70003



V70104
Za kutiju V70004



V70105
Za kutiju V70005



V70106
Za kutiju V70006



V70107
Za kutiju V70007



V70108
Za kutiju V70008



V70109
Za kutiju V70009



V70110
Za kutiju V70010



V70111
Za kutiju V70011



V70311
Za kutiju V70211



V70307
Za kutiju V70207

Razvodne ugradbene zidne kutije

Poklopci IP55 za kutije za klasične zidove



▲V72105
Za kutiju V70005

▲V72106
Za kutiju V70006

▲V72107
Za kutiju V70007

Poklopci IP55: s instalacijskom brtvom u prisutnosti prašine, vlage ili vode.



Pribor za kutije za klasične zidove



V70181
Separator za kutije
V70006, V70007, V70008,
V70009, V70010, žuti



V70191
Spojnica za povezivanje
za razvodne kutije, žuta



V70198
Vijak duljine 30 mm za
pričvršćivanje poklopaca



V70199
Vijak duljine 50 mm za
pričvršćivanje poklopaca

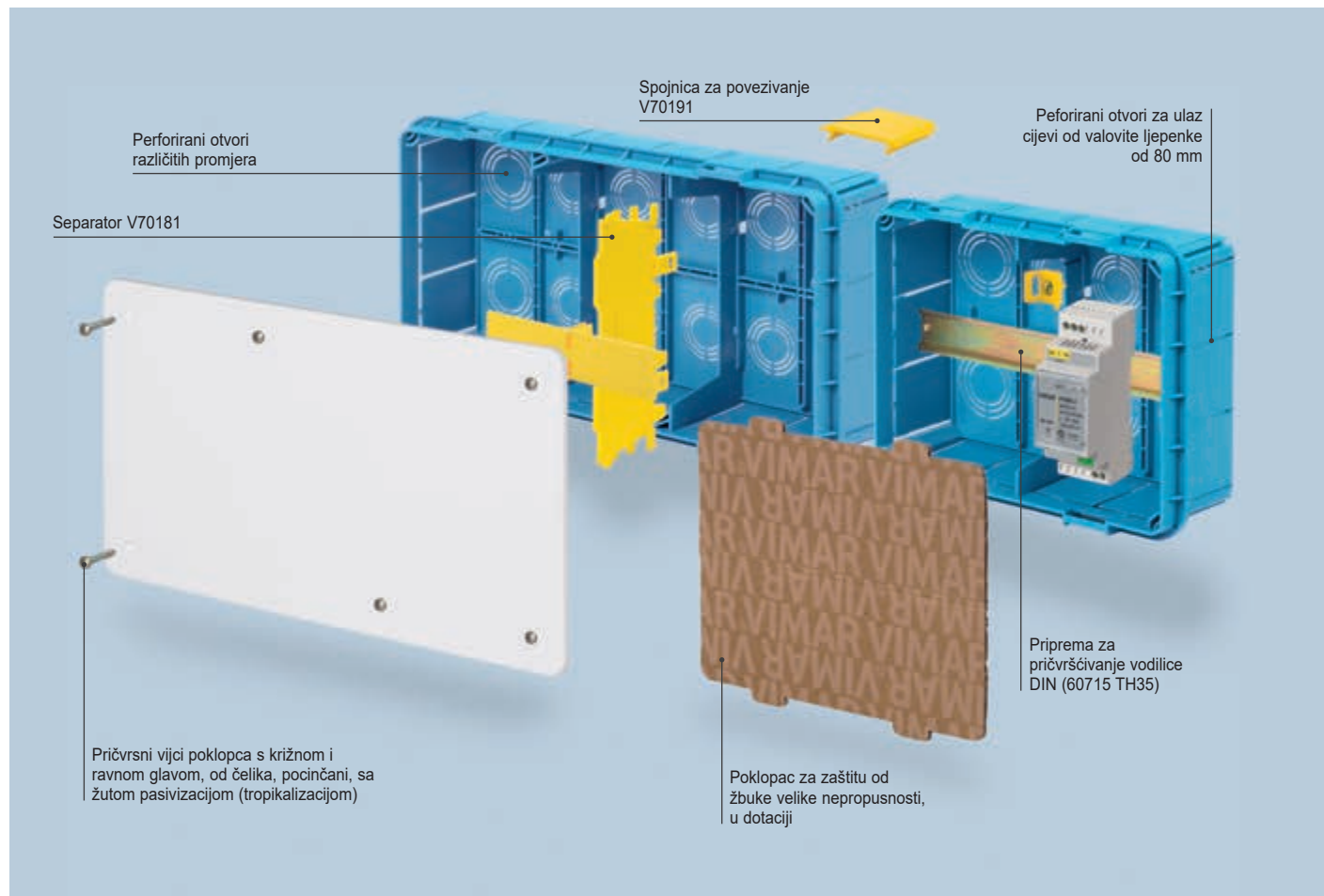

Razvodne ugradbene zidne kutije

Ugradbene razvodne kutije za klasične zidove

Mogućnost povezivanja putem spojnice V70191

Dubina ugradnje (mm)	Modularna visina poklopca (mm)							
50	118		V70001	V70002				
70	118		V70003	V70004				
70	179		V70004	V70005	V70006	V70007	V70008	V70009
120	248		V70207	V70211				

Vanjske dimenzije uređaja koje je moguće instalirati

Šifra razvodnih kutija	Duljina šipke DIN (L maks.)	Dubina uređaja (P maks.)	Visina uređaja (H maks.)
V70006	179	55	45
V70007	271	55	45
V70008	375	55	45
V70009	463	55	45
V70010	498	60	45
V70011	498	60	45
V70207	235	100	75
V70211	235	100	75

Vrsta šipke: profilirana u obliku kape TH 35-7,5 (prema standardu EN 60715)

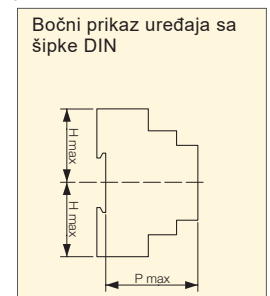
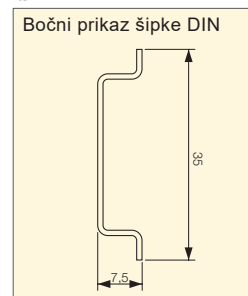

Za pričvršćivanje na kutiju upotrijebite samonarezujuće vijke ST 2,9x9,5 (EN ISO 7049)

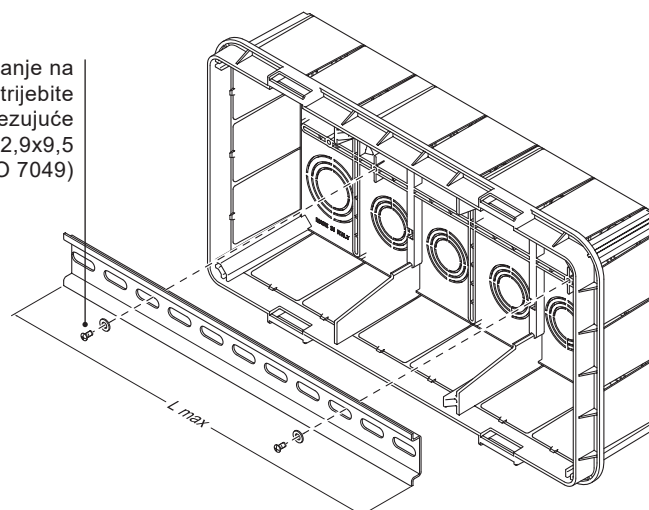

Razvodne ugradbene zidne kutije

Ugradbene razvodne kutije za tanke zidove



▲ V72006

S bijelim poklopcem.
Dimenzija kutije: 205x164x73,5 mm
Dimenzija poklopcem: 228x190 mm
Izgubljena snaga: 17 W

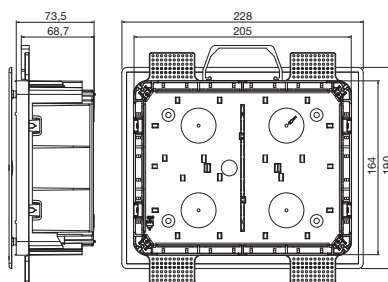

V72006



▲ V72007

S bijelim poklopcem.
Dimenzija kutije: 298x164x73,5 mm
Dimenzija poklopcem: 323x190 mm
Izgubljena snaga: 25 W

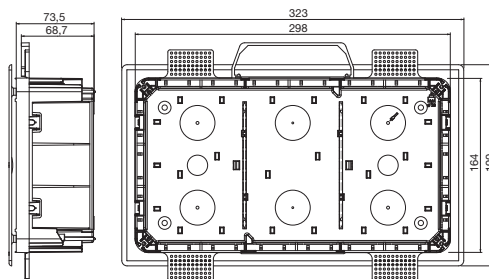

V72007



▲ V72008

S bijelim poklopcem.
Dimenzija kutije: 402x164x73,5 mm
Dimenzija poklopcem: 422x190 mm
Izgubljena snaga: 35 W

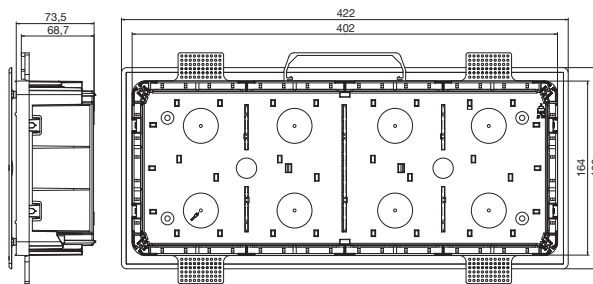

V72008



▲ V72009

S bijelim poklopcem.
Dimenzija kutije: 490x164x73,5 mm
Dimenzija poklopcem: 512x190 mm
Izgubljena snaga: 40 W

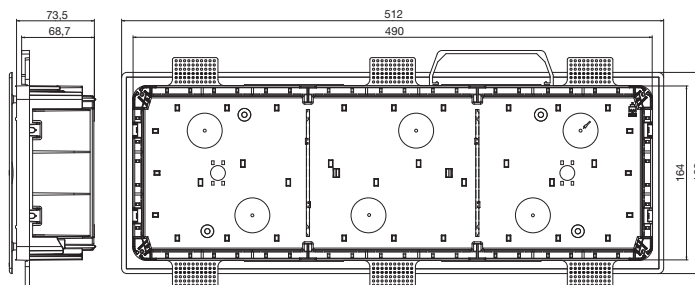

V72009

Razvodne ugradbene zidne kutije

Ugradbene razvodne kutije za tanke zidove



▲ V72211

S bijelim poklopcem.
Dimenzija kutije: 533x263x120 mm
Dimenzija poklopcem: 560x290 mm
Izgubljena snaga: 70 W

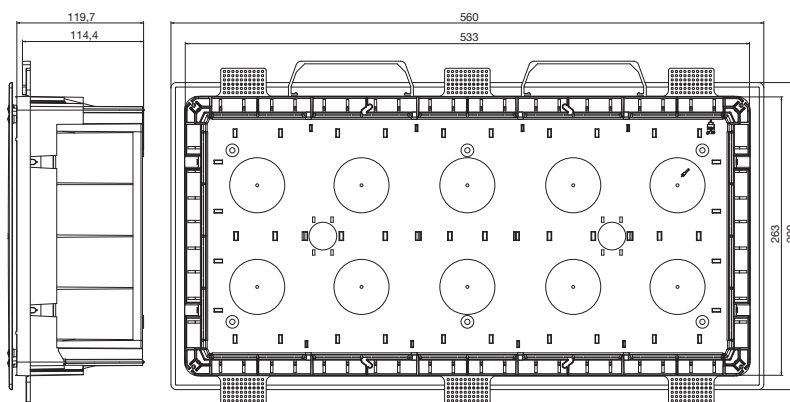

V72211

Pribor za razvodne ugradbene kutije za tanke zidove



V70181
Separator za kutije
V70006, V70007, V70008,
V70009, V70010, žuti



V70191
Spojnica za povezivanje
za razvodne kutije, žuta



V70198
Vijak duljine 30 mm za
pričvršćivanje poklopaca



V70199
Vijak duljine 50 mm za
pričvršćivanje poklopaca

Razvodne kutije za zidne stijene

Zidne razvodne kutije s kabelskom kanalicom i glatkim stijenama



V55001
IP44, utisni poklopac,
siva RAL 7035

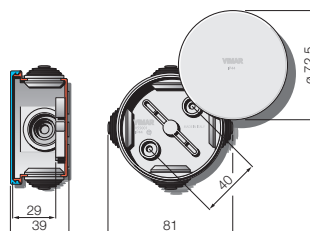

V55001



V55002
IP44, utisni poklopac,
siva RAL 7035

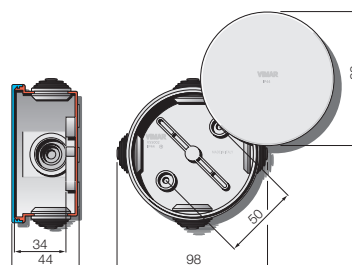

V55002



V55003
IP44, utisni poklopac,
siva RAL 7035

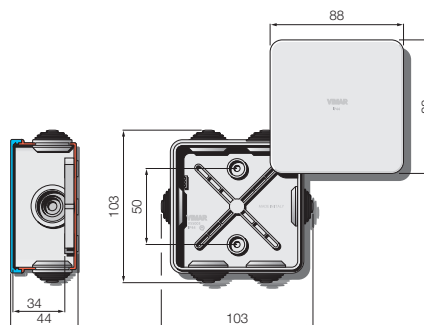

V55003



V55104
IP55, poklopac s vijcima
od nehrđajućeg čelika,
sivi RAL 7035



V55204
IP56, poklopac s vijcima
od nehrđajućeg čelika,
sivi RAL 7035

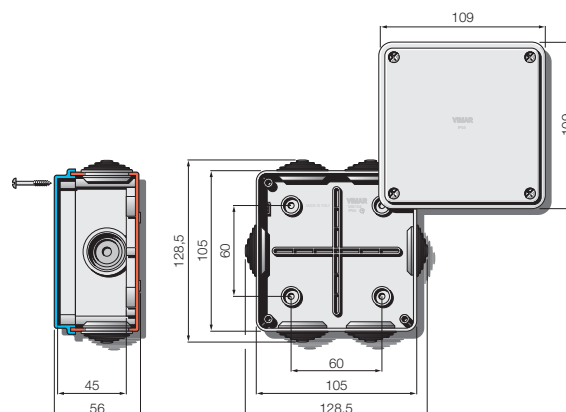

V55104
V55204

Razvodne kutije za zidne stijene

Zidne razvodne kutije s kabelskom kanalicom i glatkim stijenama



V55105
IP55, poklopac s vijcima od nehrđajućeg čelika, sivi RAL 7035



V55205
IP56, poklopac s vijcima od nehrđajućeg čelika, sivi RAL 7035

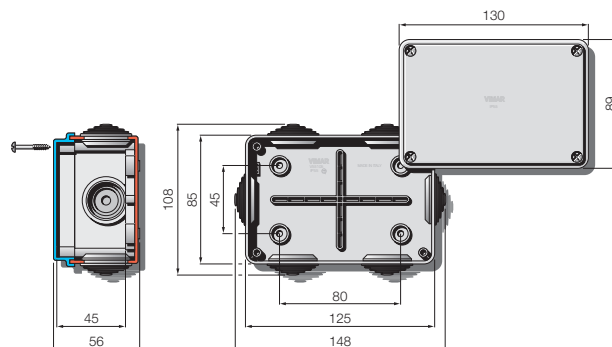

V55105
V55205



V55106
IP55, poklopac s vijcima od nehrđajućeg čelika, sivi RAL 7035



V55206
IP56, poklopac s vijcima od nehrđajućeg čelika, sivi RAL 7035

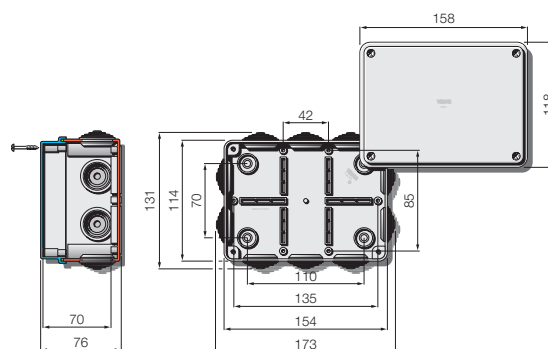

V55106
V55206



V55107
IP55, poklopac s vijcima od nehrđajućeg čelika, sivi RAL 7035



V55207
IP56, poklopac s vijcima od nehrđajućeg čelika, sivi RAL 7035

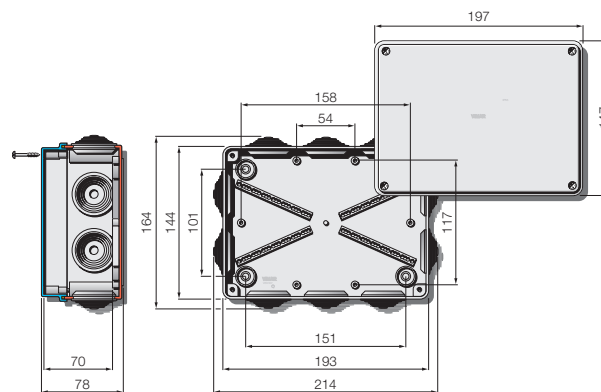

V55107
V55207



V55108
IP55, poklopac s vijcima od nehrđajućeg čelika, sivi RAL 7035



V55208
IP56, poklopac s vijcima od nehrđajućeg čelika, sivi RAL 7035

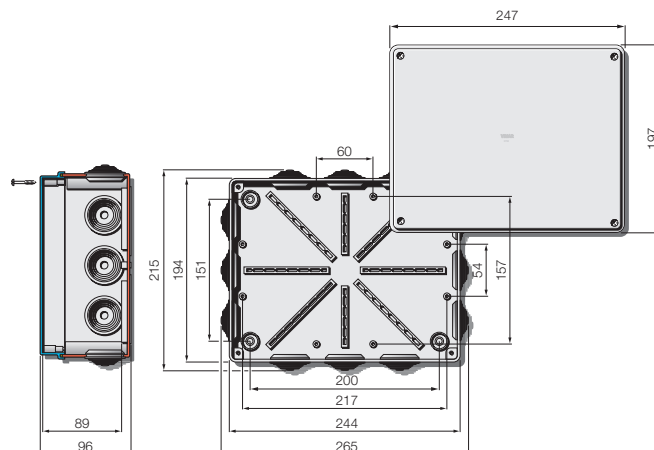

V55108
V55208

Razvodne kutije za zidne stijene

Zidne razvodne kutije s kabelskom kanalicom i glatkim stijenama



V55109
IP55, poklopac s vijcima od izolacijskog materijala, siva RAL 7035. Isporučuje se s parom šarki



V55209
IP56, poklopac s vijcima od izolacijskog materijala, siva RAL 7035. Isporučuje se s parom šarki

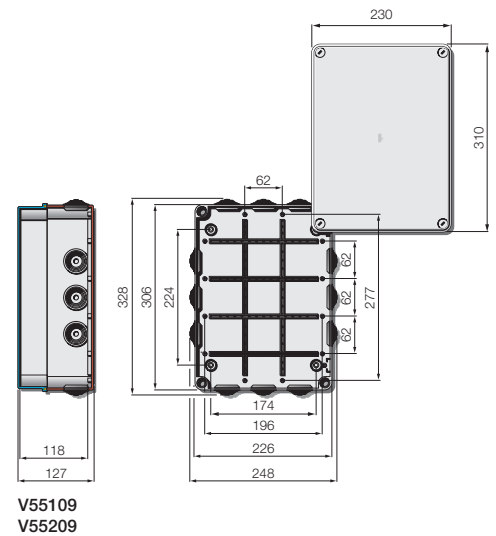

V55110
IP55, poklopac s vijcima od izolacijskog materijala, siva RAL 7035. Isporučuje se s parom šarki



V55210
IP56, poklopac s vijcima od izolacijskog materijala, siva RAL 7035. Isporučuje se s parom šarki

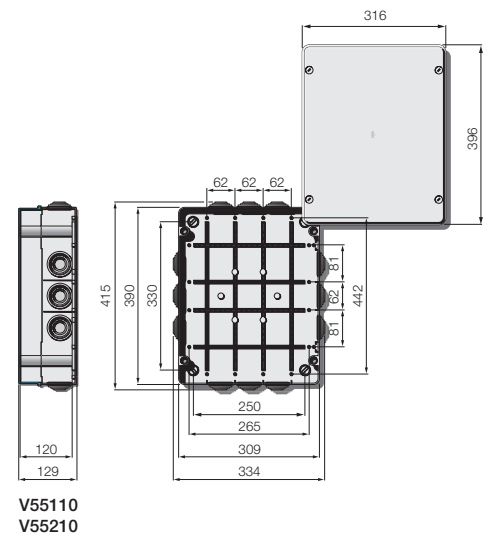

Potpuna izolacija koju je moguće postići pomoću odgovarajućih čepova za pokrivanje vijaka.



Neispadajući vijci od nehrđajućeg čelika za laku ugradnju i održavanje.



Rebrasta struktura na dnu kutije za pričvršćivanje priključnih glava i ploča. Sjedište za priključnu glavu za kontinuitet uzemljenja.

Razvodne kutije za zidne stijene

Zidna razvodna kutija glatkih stijenki i visokog poklopca



V55218

IP55, poklopac s vijcima
od nehrđajućeg čelika,
sivi RAL 7035

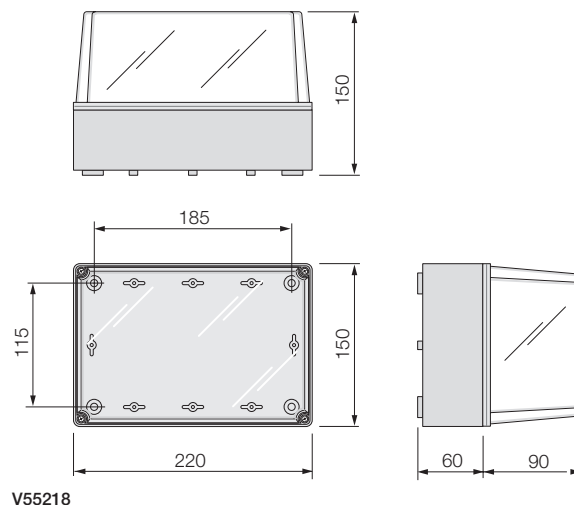

Razvodne kutije za zidne stijene

Temperatura tijekom postavljanja	Ispitivanje užarenom žicom (Glow Wire test)	utisno (IP44)	S kanalicama za kabele s vijcima (IP55)	broj kanalica za kabele	ø maks. cijev (u mm)	Glatke stijenske, slijepi poklopac (IP56)	Glatke stijenske, visoki slijepi poklopac (IP55)	Unutarnje dimenzije (u mm)
-5 °C +60 °C	960 °C	V55001*	---	4	ø 20	---	---	ø 65x35
		V55002*	---	4	ø 20	---	---	ø 80x40
		V55003*	---	6	ø 20	---	---	80x80x40
		---	V55104*	6	ø 25	V55204*	---	100x100x50
		---	V55105*	6	ø 25	V55205*	---	120x80x50
-15 °C +60 °C	650 °C	---	V55106	10	ø 25	V55206	---	150x110x70
		---	V55107	10	ø 32	V55207	---	190x140x70
		---	---	---	---	---	V55218	220x150x150
		---	V55108	12	ø 32	V55208	---	240x190x90
		---	V55109	12	ø 40	V55209	---	300x220x120
		---	V55110	12	ø 40	V55210	---	380x300x120

* Zbog potpune izolacije prema standardima EN 60439-1, pokraj svakog pričvrstnog otvora mora se u odgovarajuće ležište umetnuti čep za pokrivanje vijka V55900.

Kanalice za kabele

Dimenzije uvodnice kabela (u mm)	V55001	V55002	V55003	V55104	V55105	V55106	V55107	V55108	V55109	V55110
A	23	23	23	29	29	30	38	38	38	40
B	20	20	20	25	25	25	32	32	32	45
C	4	4	6	6	6	10	10	10	10	12

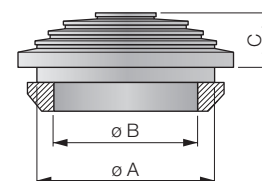

Ugradbene centralne upravljačke jedinice

Ugradbene centralne upravljačke jedinice IP40



V53108
8 modula, zajedno s vodilicom
DIN (60715 TH35), prozirna
zatamnjena vratašca



V53108.B
8 modula, zajedno s vodilicom
DIN (60715 TH35), bijela
vratašca

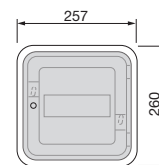

V53108
V53108.B



V53308
Kutija za klasične zidove
- 8 modula, (GW 650 °C)
Izgubljena snaga: 18 W



V53708
Kutija za tanke zidove
- 8 modula, (GW 850 °C)
Izgubljena snaga: 18 W

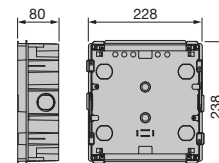

V53308
V53708



V53112
12 modula, zajedno s vodilicom
DIN (60715 TH35), prozirna
zatamnjena vratašca



V53112.B
12 modula, zajedno s vodilicom
DIN (60715 TH35), bijela
vratašca

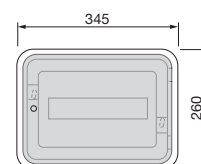

V53112
V53112.B



V53312
Kutija za klasične zidove
- 12 modula, (GW 650 °C)
Izgubljena snaga: 22 W



V53712
Kutija za tanke zidove
- 12 modula, (GW 850 °C)
Izgubljena snaga: 22 W

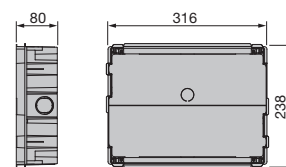

V53312
V53712

Ugradbene centralne upravljačke jedinice IP40 i kutije - Pribor

Središnje upravljačke jedinice		Kutije		Pribor	
Moduli	Šifra	Šifra za klasične zidove	Šifra za tanke zidove	Posebni pribor	Zajednički pribor
8	V53108	V53308	V53708	V53561 Noslač priključnih glava za 8 modula	V53597 Brava s ključem V53599 Pokrovna traka za rupe V53595 Spojnica za povezivanje V53552... Priključna glava s vijcima
12	V53112	V53312	V53712	V53562 Noslač priključnih glava za 12, 24 i 36 modula	
24	V53124	V53324	V53724	V53572 Separator za 24 i 36 modula	
36	V53136	V53336	V53736	V53582 Prirubnica za zaustavljanje cijevi za 12, 24 i 36 modula	
54	V53154	V53354	V53754	V53563 Noslač priključnih glava za 54 i 72 modula	
72	V53172	V53372	V53772	V53573 Separator za 54 i 72 modula V53583 Prirubnica za zaustavljanje cijevi za 54 i 72 modula	

Ugradbene centralne upravljačke jedinice

Ugradbene centralne upravljačke jedinice IP40



V53124
24 modula, zajedno s vodilicom
DIN (60715 TH35), prozirna
zatamnjena vratašca



V53124.B
24 modula, zajedno s vodilicom
DIN (60715 TH35),
bijela vratašca

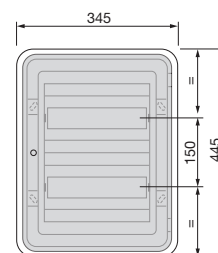

V53124
V53124.B



V53324
Kutija za klasične zidove
- 24 modula, (GW 650 °C)
Izgubljena snaga: 40 W



V53724
Kutija za tanke zidove
- 24 modula, (GW 850 °C)
Izgubljena snaga: 40 W

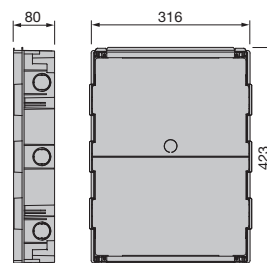

V53324
V53724



V53136
36 modula, zajedno s vodilicom
DIN (60715 TH35), prozirna
zatamnjena vratašca



V53136.B
36 modula, zajedno s vodilicom
DIN (60715 TH35),
bijela vratašca

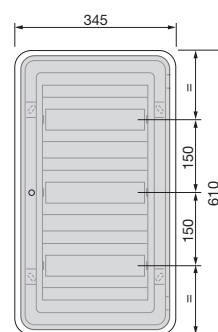

V53136
V53136.B



V53336
Kutija za klasične zidove
- 36 modula, (GW 650 °C)
Izgubljena snaga: 50 W



V53736
Kutija za tanke zidove
- 36 modula, (GW 850 °C)
Izgubljena snaga: 50 W

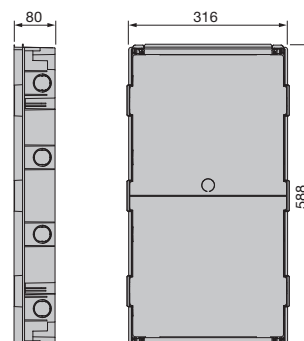

V53336
V53736

Ugradbene centralne upravljačke jedinice

Ugradbene centralne upravljačke jedinice IP40



V53154
54 modula, zajedno s vodilicom
DIN (60715 TH35), prozirna
zatamnjena vratašca



V53154.B
54 modula, zajedno s vodilicom
DIN (60715 TH35),
bijela vratašca

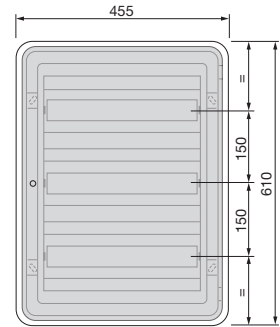

V53154
V53154.B

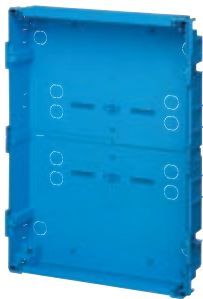

V53354
Kutija za klasične zidove
- 54 modula, (GW 650 °C)
Izgubljena snaga: 63 W

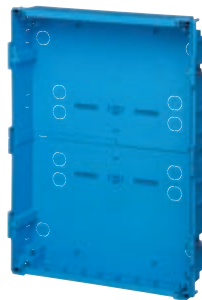

V53754
Kutija za tanke zidove
- 54 modula, (GW 850 °C)
Izgubljena snaga: 63 W

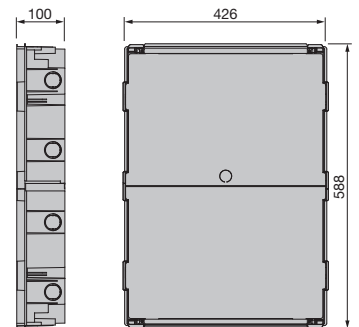

V53354
V53754



V53172
72 modula, zajedno s vodilicom
DIN (60715 TH35), prozirna
zatamnjena vratašca



V53172.B
72 modula, zajedno s vodilicom
DIN (60715 TH35),
bijela vratašca

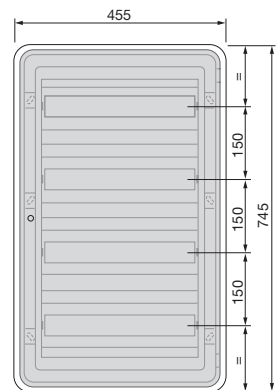

V53172
V53172.B

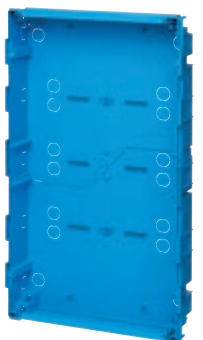

V53372
Kutija za klasične zidove
- 72 modula, (GW 650 °C)
Izgubljena snaga: 82 W

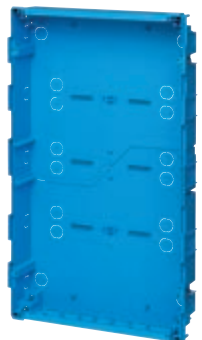

V53772
Kutija za tanke zidove
- 72 modula, (GW 850 °C)
Izgubljena snaga: 82 W

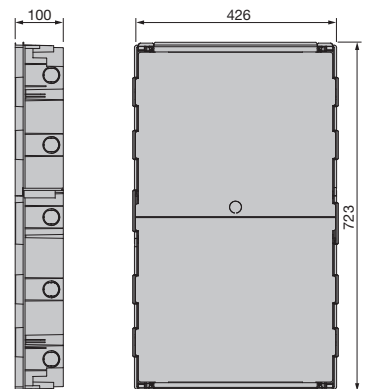

V53372
V53772

Pribor za centralne ugradbene jedinice

Pribor za centralne ugradbene jedinice IP40



V53572
Odvojni separator s 12 modula na kvačenje na kutiju za centralne jedinice s 26 i 36 modula, žuti



V53573
Odvojni separator s 18 modula na kvačenje na kutiju za centralne jedinice s 54 i 72 modula, žuti



V53595
Spojnica za povezivanje kutija za vodoravnu kompoziciju, žuta



V53582
Prirubnica za zadržavanje cijevi s 12 modula na kvačenje za kutiju zbog instaliranja u okomitoj bateriji centralnih upravljačkih jedinica s 12, 24 i 36 modula, žuta



V53583
Prirubnica za zadržavanje cijevi s 18 modula na kvačenje za kutiju zbog instaliranja u okomitoj bateriji centralnih upravljačkih jedinica s 54 i 72 modula, žuta



V53597
Brava s metalnim ključem. Isporučuje se s 2 ključa



V53599
Pokrovna traka za rupe za estetski izgled centralne jedinice, duljina 500 mm uz mogućnost rezanja po želji, bijela



V53598
Pokrovna traka za rupe za 4 modula DIN za estetski izgled centralne jedinice, mogućnost rezanja po želji, bijela



03310.S
Nosач za aparate sa šipkom DIN, zauzima 8 modula od 17,5 mm

Nosač priključne glave i priključne glave za ugradbene centralne jedinice IP40



V53561
Nosач za centralne jedinice od 8 modula, s kvačenjem na kutiju, sivi



V53562
Nosач za centralne jedinice od 12, 24 i 36 modula, s kvačenjem na kutiju, sivi



V53563
Nosач za centralne jedinice od 54 i 72 modula, s kvačenjem na kutiju, sivi



V53552
Odvojiva priključna glava s vijkom, 6 otvora, za kabele od 1,5 mm² do 16 mm², za brzu ugradnju na nosač, tamno plava



V53552.V
Odvojiva priključna glava s vijkom, 6 otvora, za kabele od 1,5 mm² do 16 mm², za brzu ugradnju na nosač, zelena

SPREMNICI I CENTRALNE UPRAVLJAČKE JEDINICE

Središnje upravljačke jedinice za distribuciju podataka



Ploča za distribuciju signala u stanu (QDSA) IP40



03310

Ploča za distribuciju signala u stanu (QDSA), sastoji se od:

- ugradbena kutija V53354;
- bijela vratašca;
- nosač za 16 konektora RJ45 Keystone ili optičkih provodnika;
- višestruka telefonska utičnica s 5 izlaza;
- višestruka predinstalirana utičnica s prekidačem;
- 3 nosača 03310.S;
- 3 m čičak trake;
- 6 konektora 03009.12
- 2 provodnika optičkih vlakana SC/APC;
- utične žice 03019.05 i 03113.SC.

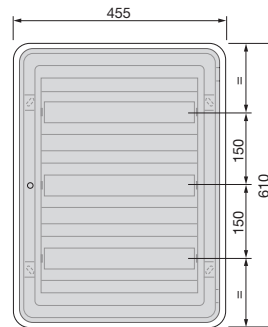

03310



V53354

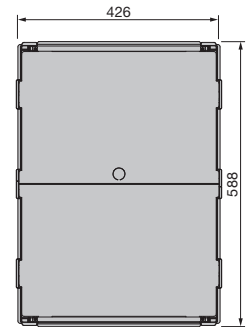

Centar za optičke usluge u zgradi (CSOE) IP40



03130

Centar za optičke usluge u zgradi (CSOE) antenski modul za upravljanje uslugama u stambenom prostoru (TV SAT i DTV), bijeli. Dimenzije: 450x150x155 mm



03131

Centar za optičke usluge u zgradi (CSOE) distribucijski modul za upravljanje s 8 jedinica stanovanja, bijeli. Dimenzije: 450x150x130 mm

Terminal glave IP65



03134

Razvodna kutija, predviđena za ulaz 2 kabela i 12 optičkih vlakana za razne dimenzije IP65, siva RAL 7035. Isporučuje se sa sigurnosnim ključem za zatvaranje. Dimenzije: 245x210x65 mm

Priključna kutija za optička vlakna u stanu (STOA)



03140.30

Priključna kutija za optička vlakna u stanu (STOA), unaprijed pripremljena za priključivanje 4 konektora SC/APC Simplex, monomodalnog kabela od optičkih vlakana loose 9/125 μm G.657.A2 s 8 vlakana, s oblogom LSZH, bijeli - 30 metara

03140.50

Kao gore, 50 metara



Uređaj s otvorenim vratima.

Ugradbene centralne upravljačke jedinice

Ugradbene centralne upravljačke jedinice IP40 s vratima s okomitom šarkom

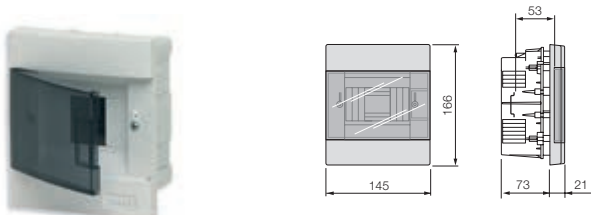

V52404
4 modula, zajedno s vodilicom DIN (60715 TH35), bijela RAL 9003, s prozirnim zatamnjеним vratašcima. Izgubljena snaga: 14 W

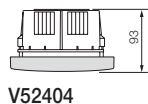

V52404

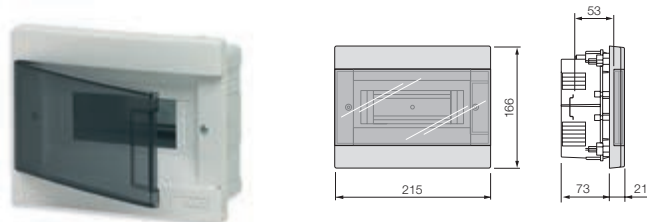

V52408
8 modula, zajedno s vodilicom DIN (60715 TH35), bijela RAL 9003, s prozirnim zatamnjеним vratašcima. Izgubljena snaga: 19 W

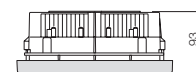

V52408



V52412
12 modula, zajedno s vodilicom DIN (60715 TH35), bijela RAL 9003, s prozirnim zatamnjеним vratašcima. Izgubljena snaga: 28 W

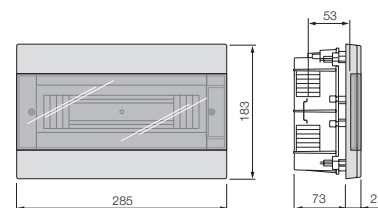

V52412



V52424
24 modula, zajedno s vodilicom DIN (60715 TH35), bijela RAL 9003, s prozirnim zatamnjеним vratašcima. Izgubljena snaga: 58 W

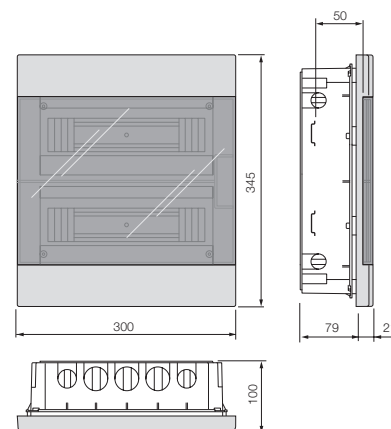

V52424



V52436
36 modula, zajedno s vodilicom DIN (60715 TH35), bijela RAL 9003, s prozirnim zatamnjеним vratašcima. Izgubljena snaga: 68 W

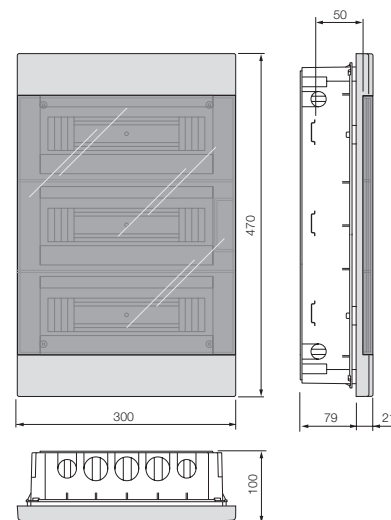

V52436

Zidne centralne upravljačke jedinice

Zidne centralne upravljačke jedinice IP40



V50405

5 modula (4+1), gornji i donji perforirani otvori na zidovima, upotpunjeno vodilicom DIN (60715 TH35), siva RAL 7035, s prozirnim zatamnjanim vratašcima. Izgubljena snaga: 9 W

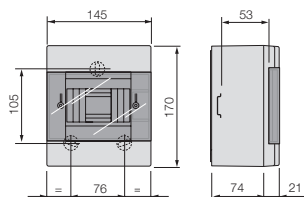

V50405

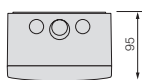

V50408

8 modula, gornji i donji perforirani otvori na zidovima, upotpunjeno vodilicom DIN (60715 TH35), siva RAL 7035, s prozirnim zatamnjanim vratašcima. Izgubljena snaga: 12 W

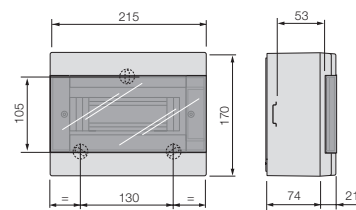

V50408



V50412

12 modula (12+1), gornji i donji perforirani otvori na zidovima, upotpunjeno vodilicom DIN (60715 TH35), siva RAL 7035, s prozirnim zatamnjanim vratašcima. Izgubljena snaga: 18 W



V50312

12 modula (12+1), glatke stijenke, zajedno s vodilicom DIN (60715 TH35), siva RAL 7035. Izgubljena snaga: 19 W

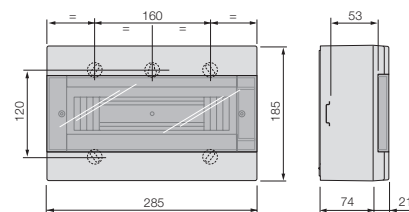

**V50312
V50412**

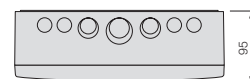

V50424

24 modula, gornji i donji perforirani otvori na zidovima, upotpunjeno vodilicom DIN (60715 TH35), siva RAL 7035, s prozirnim zatamnjanim vratašcima. Izgubljena snaga: 31 W



V50324

24 modula, glatke stijenke, zajedno s vodilicom DIN (60715 TH35), siva RAL 7035. Izgubljena snaga: 37 W

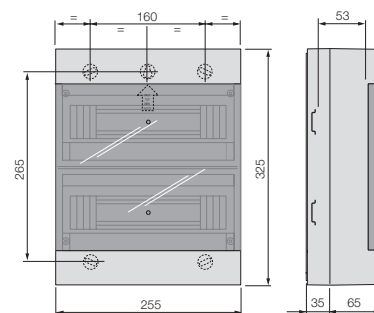

**V50324
V50424**



V50436

36 modula, gornji i donji perforirani otvori na zidovima, upotpunjeno vodilicom DIN (60715 TH35), siva RAL 7035, s prozirnim zatamnjanim vratašcima. Izgubljena snaga: 37 W

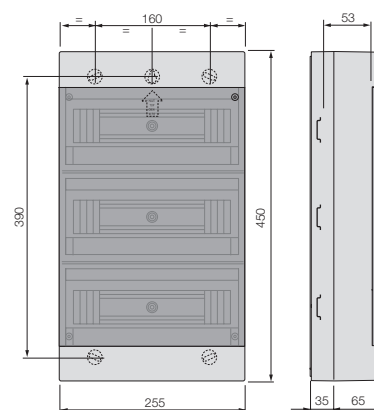

V50436

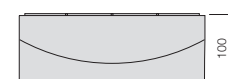

Zidne centralne upravljačke jedinice

Zidne centralne jedinice IP55 s vratima s vodoravnom šarkom



V51003

3 modula (1+2), s čepovima za dvostruku izolaciju, zajedno s vodilicom DIN (60715 TH35), siva RAL 7035, s prozirnim zatamnjenim vratašcima. Izgubljena snaga: 9 W

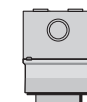
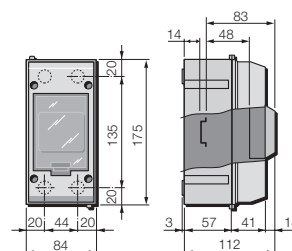

V51003



V51005

5 modula (4+1), s čepovima za dvostruku izolaciju, zajedno s vodilicom DIN (60715 TH35), siva RAL 7035, s prozirnim zatamnjenim vratašcima. Predviđena za 2 nosača priključnih glava V51853. Izgubljena snaga: 12 W

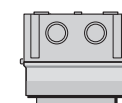
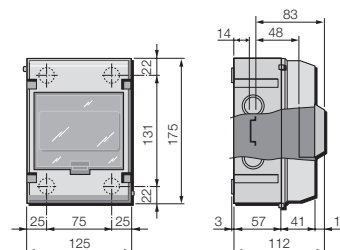

V51005



V51008

8 modula, s čepovima za dvostruku izolaciju, zajedno s vodilicom DIN (60715 TH35), siva RAL 7035, s prozirnim zatamnjenim vratašcima. Izgubljena snaga: 21 W

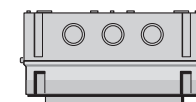
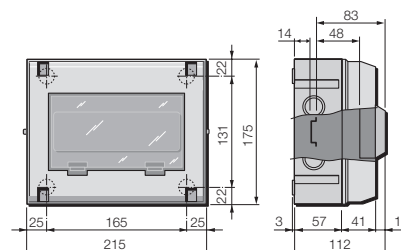

V51008



V51012

12+1 modula, s čepovima za dvostruku izolaciju, zajedno s vodilicom DIN (60715 TH35), siva RAL 7035, s prozirnim zatamnjenim vratašcima. Izgubljena snaga: 26 W

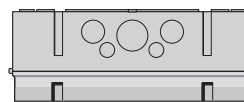
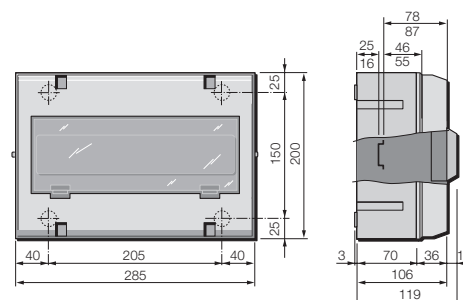

V51012

Zidne centralne upravljačke jedinice

Zidne centralne upravljačke jedinice IP55 s vratima s okomitom šarkom



V51112

12 modula, zajedno s vodilicom DIN (60715 TH35) koju je moguće prilagoditi nestandardnim aparatima, siva RAL 7035, s prozirnim vratašcima i čepovima za dvostruku izolaciju. Izgubljena snaga: 21 W

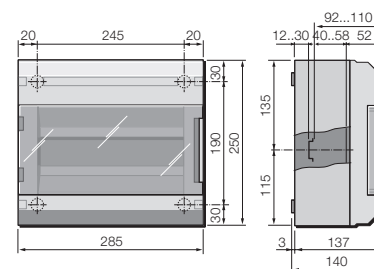

V51112



V51124

24 modula, zajedno s vodilicom DIN (60715 TH35) koju je moguće prilagoditi nestandardnim aparatima, siva RAL 7035, s prozirnim vratašcima i čepovima za dvostruku izolaciju. Izgubljena snaga: 27 W

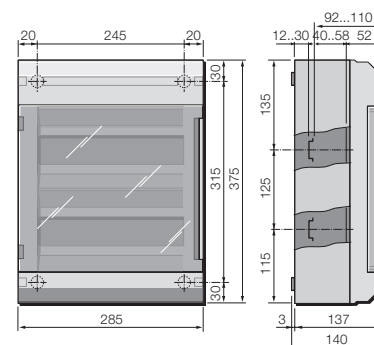

V51124



V51136

36 modula, zajedno s vodilicom DIN (60715 TH35) koju je moguće prilagoditi nestandardnim aparatima, siva RAL 7035, s prozirnim vratašcima i čepovima za dvostruku izolaciju. Izgubljena snaga: 32 W

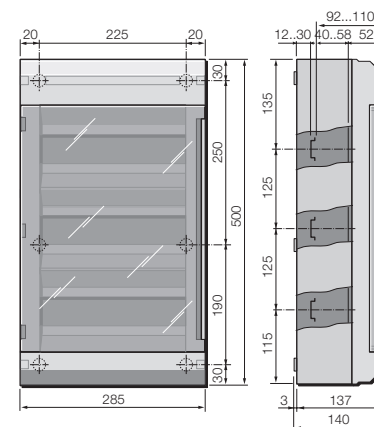

V51136

Zidne centralne upravljačke jedinice

Podlošci za DIN (60715 TH35) šinsku instalaciju



V51921
1 modul, zauzima 1,5 modula
od 17,5 mm, siva RAL 7035.
Isporučeno sa zaštitnom dijafragmom



V51922
2 modula, zauzima 3 modula
od 17,5 mm, siva RAL 7035.
Isporučeno sa zaštitnom dijafragmom



V51923
3 modul, zauzima 4 modula
od 17,5 mm, siva RAL 7035.
Isporučeno sa zaštitnom dijafragmom

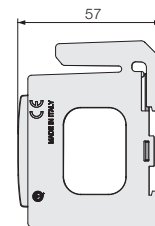

V51921
V51922
V51923

Priključne glave uzemljenja od mesinga, upotpunjene pričvrsnim vijkom



V51808
2 otvora \varnothing 6 mm
+ 6 otvora \varnothing 4 mm



V51810
2 otvora \varnothing 6 mm
+ 8 otvora \varnothing 4 mm



V51816
4 otvora \varnothing 6 mm
+ 13 otvora \varnothing 4 mm

Zidna zaštitna kućišta IP40



V50002
2 modula (1+1),
siva RAL 7035.
Izgubljena snaga: 5 W

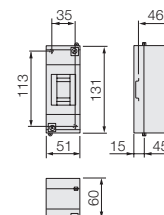

V50002



V50004
4 modula (3+1),
siva RAL 7035.
Izgubljena snaga: 7 W

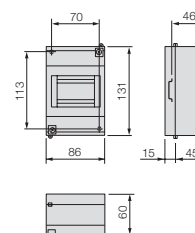

V50004



V50006
6 modula (4+2),
siva RAL 7035.
Izgubljena snaga: 12 W

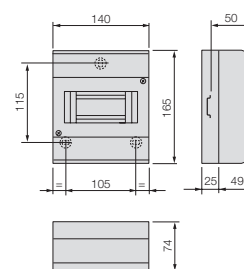

V50006

Zidne centralne upravljačke jedinice

Zidna zaštitna kućišta IP40





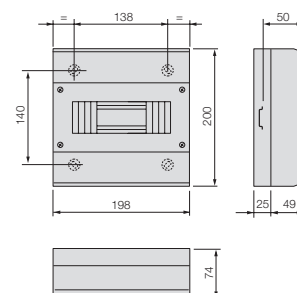













V50008
8 modula (4+4),
siva RAL 7035.
Izgubljena snaga: 21 W



V50008

Broj i vrsta otvora koje je moguće probiti na zidnim centralnim jedinicama i zaštitnim kućištima

Članak	Ø otvor (mm)	19	20	23	29	37	16 o 25	20 o 32	25 o 32	32 o 40	23 o 29	29 o 37	Položaj unaprijed izrađenih pukotina
	Korak PG	11	13,5	16	21	29	---	---	---	---	16 o 21	21 o 29	
V50002	čelni dijelovi	---	---	n 2	---	---	---	---	---	---	---	---	
V50004	bočne stranice	---	---	n 2	---	---	---	---	---	---	---	---	
V50006	čelni dijelovi	---	---	---	---	---	---	n 6	---	---	---	---	
	bočne stranice	---	---	---	---	---	---	n 4	---	---	---	---	
V50008	čelni dijelovi	---	---	---	---	---	---	n 4	---	n 2	---	---	
	bočne stranice	---	---	---	---	---	---	n 4	---	---	---	---	
V50405	čelni dijelovi	---	n 4	---	---	---	---	---	---	---	n 2	---	
	glatke bočne stranice	---	---	---	---	---	---	---	---	---	---	---	
V50408	čelni dijelovi	---	n 4	n 4	---	---	---	---	---	---	n 2	---	
	bočne stranice	---	---	---	---	---	---	---	---	---	---	---	
V50412	čelni dijelovi	---	n 8	---	---	---	---	---	---	---	n 4	n 2	
	glatke bočne stranice	---	---	---	---	---	---	---	---	---	---	---	
V50424	čelni dijelovi	---	---	---	---	---	n 4	n 4	n 2	---	---	---	
	bočne stranice	---	---	---	---	---	---	---	---	---	---	---	
V50436	čelni dijelovi	---	---	---	---	---	n 4	n 4	n 2	---	n 4	---	
	glatke bočne stranice	---	---	---	---	---	---	---	---	---	---	---	
V51003	čelni dijelovi	---	---	---	---	---	---	---	---	---	n 2	---	
	glatke bočne stranice	---	---	---	---	---	---	---	---	---	---	---	
V51005	čelni dijelovi	---	---	---	---	---	---	---	---	---	n 4	---	
	bočne stranice	---	---	---	---	---	---	---	---	---	n 4	---	
V51008	čelni dijelovi	---	---	---	---	---	---	---	---	---	n 6	---	
	bočne stranice	---	---	---	---	---	---	---	---	---	n 4	---	
V51012	čelni dijelovi	n 4	---	---	n 4	n 2	---	---	---	---	---	---	
	glatke bočne stranice	---	---	---	---	---	---	---	---	---	---	---	
V51112	čelni dijelovi	---	---	---	---	---	---	---	---	---	n 8	n 2	
	bočne stranice	---	---	n 4	---	---	---	---	---	---	---	---	

Napomena. Zidne centralne jedinice bez vratašaca nemaju perforirane otvore.

Toplinska regulacija i upravljanje energijom od str. 144

Toplinska regulacija u tercijarnom sektoru od str. 146

Videoportafonija u stambenom prostoru od str. 148



Rješenje radio EnOcean

od str. 150



od str. 152

Kontrola ulaza za tercijarne aplikacije od str. 154

Distribucija podataka i multimedijalnost u tercijarnom sektoru od str. 156



Osnovna domotika po načelu Plug&Play

od str. 158

Toplinska regulacija i upravljanje energijom

Stan od 80 m² s uređajima za toplinsku regulaciju i energetska nadzor pomoću kronotermostata sa zaslonom osjetljivim na dodir.

Termostati i kronotermostati opremljeni intuitivnim komandama i kapacitivnim zaslonima osjetljivima na dodir velike osjetljivosti omogućuju upravljanje temperaturom na lak i cjelovit način, prikazivanjem troškova i olakšavajući štednju energije pomoću mjerača energije za vodilice DIN i mogućnošću brojanja sati uključenosti sustava. U primjeru je ilustriran tradicionalni sustav za toplinsku regulaciju (sa zonskim ventilima i kondenzacijskim bojlerom), gdje se nalazi i fotonaponski sustav za proizvodnju obnovljive energije.

- Instalirana su 3 kronotermostata sa zaslonom osjetljivim na dodir 02955.B s 3 modula, povezana s mjeračima energije 02960 koji očitavaju energiju proizvedenu pomoću fotonaponskih ploča, energiju koju su potrošili kućanski aparati i energiju električnih opterećenja povezanih s istom linijom kao i izmjeničnu energiju mreže potrebnu za rad sustava.
- Vrijednosti trenutne snage i kumulirane energije (i vrijednosti napona) prikazuju se pojedinačno na zaslonima kronotermo-

stata osjetljivima na dodir u dnevnoj sobi, u kuhinji i na razvodnoj ploči; na kronotermostatu u kuhinji može se omogućiti zvučno upozorenje prekoračenja ugovorno određenog praga koje će obavijestiti korisnika o mogućem odstupanju izmjeničnog brojača zbog prekomjerne mrežne snage. Svi uređaji posjeduju funkciju **Ecometer** koja jamči racionalnije korištenje energije zgrade kako bi se potaknula veća energetska i ekonomska štednja.

- U sobi je instaliran termostat osjetljiv na dodir 02950.B spojen na sondu NTC 14432 za mjerenje temperature kupaonice.
- U jednoj od soba nalazi se drugi elektronički termostat osjetljiv na dodir (02950.B) spojen na žični senzor NTC 02965.1 za očitavanje vanjske temperature.
- Komanda na ulazu omogućava centraliziranu kontrolu zadane vrijednosti raznih zona (paljenje u komfornom načinu rada ili u načinu noćnog smanjenja) pomoću višefunkcijskih uređaja uz mogućnost konfiguriranja.



Elektronički kronotermostat sa zaslonom osjetljivim na dodir s funkcijom Ecometer; omogućava prikaz proizvedene energije.



Mjerač energije sa senzorom struje.



Elektronički termostat sa zaslonom osjetljivim na dodir omogućava prikazivanje i temperature koju je detektirala sonda instalirana u nekoj drugoj prostoriji.



Elektronički senzor temperature.



Što učiniti:

Posjetite web-mjesto www.vimar.com, u odjeljku Podrška/Praktični video vodič/Praktični vodič/Klima kako biste pogledali praktični video vodič:

- “Kronotermostat osjetljiv na dodir s 3 ugradna modula Šif. 02955: Upravljanje klima uređajem”;
- “Kronotermostat osjetljiv na dodir s 3 ugradna modula Šif. 02955: Integrativne funkcije”;
- “Kronotermostat osjetljiv na dodir s 3 ugradna modula Šif. 02955: Upravljanje energijom”.



Toplinska regulacija i upravljanje energijom

Tipičan sustav: stan od 80 m² s uređajima za toplinsku regulaciju i energetske nadzor pomoću kronotermostata sa zaslonom osjetljivim na dodir.

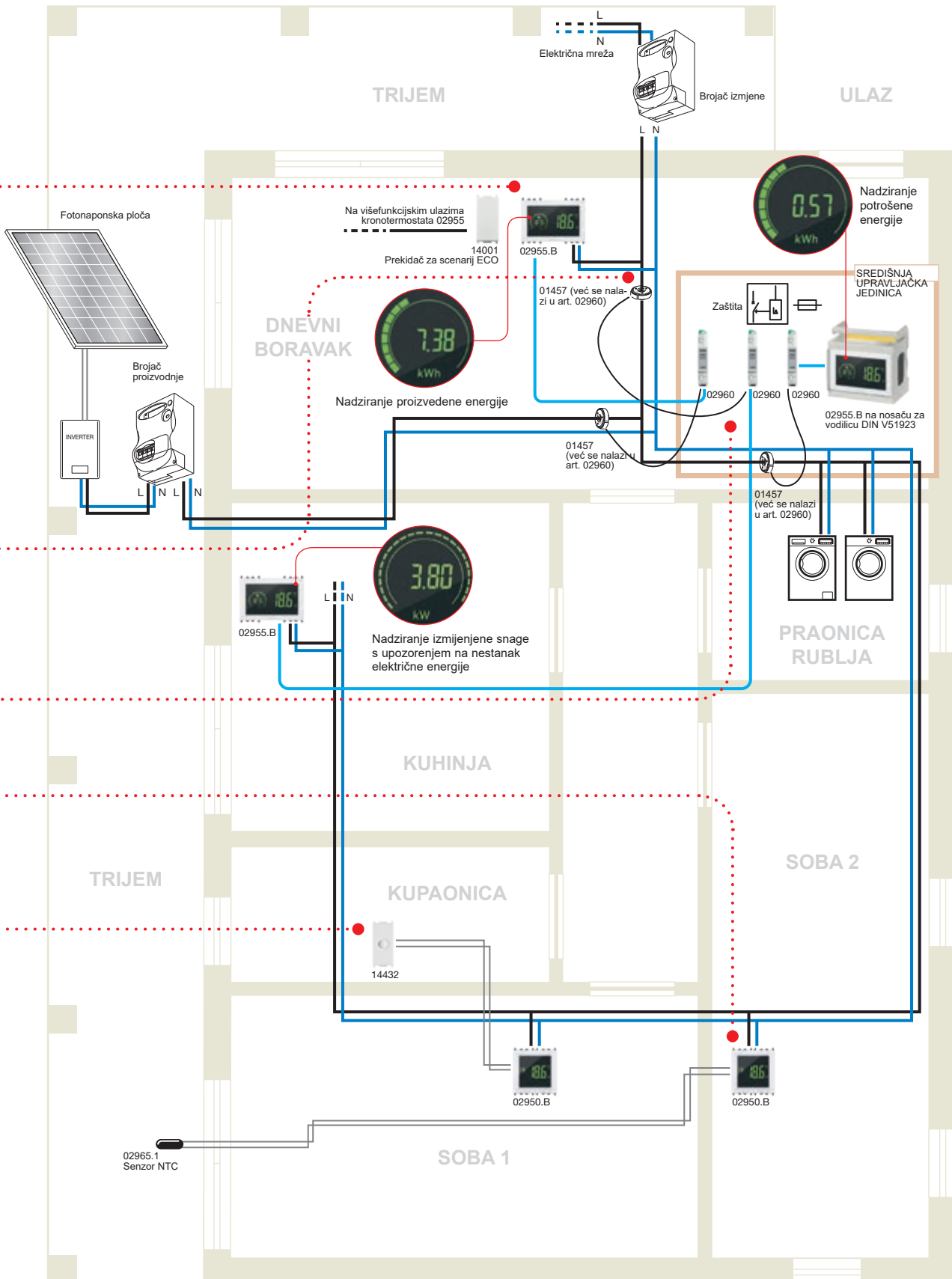

Toplinska regulacija u tercijarnom sektoru

Škola s uređajima za toplinsku regulaciju za aktivaciju zonskih ventila i elektroničkim sondama temperature i vlage sučeljem povezane sa sustavom za hidrauličku toplinsku regulaciju.

Primjer prikazuje sustav toplinske regulacije u jednoj školi s mogućnošću centraliziranog načina kontroliranja raznih zona u zgradi posredstvom zonskih termostata s relejnim izlazima.

Termostati s kapacitivnim zaslonom osjetljivim na dodir i pozadinskim osvjetljenjem u boji omogućuju regulaciju u grijanju/klimatizaciji s aktiviranjem On/Off ili PID. Opremljeni su višefunkcijskim ulazom koji se može konfigurirati za aktiviranje načina rada s noćnom redukcijom ili regulacijom s udobnošću zadane vrijednosti ili invertirati način rada za ljeto/zimu; posjeduju ulaz za vanjski elektronički senzor temperature.

• Instalirani su termostati sa zaslonom osjetljivim na dodir (art. 02950.BN) unutar ureda uprave, predavaonica, multimedijske dvorane i knjižnice. Svi uređaji zajedničkih zona mogu se blokirati pomoću PIN-a: na taj se način studentima može

onemogućiti pristup konfiguraciji uređaja, načinima rada, a opseg temperatura koje je moguće postaviti putem korisničkog sučelja se ograničava.

- Uz to, u uredu uprave spojena je centralizirana komanda za uključivanje/isključivanje (art. 14001.SL) za opće isključivanje sustava prilikom zatvaranja škole ili radi aktivacije noćne redukcije na kraju predavanja zbog štednje energije. Umjesto toga se može instalirati sat programator (art. 14448.SL) za programiranje vremenskog rasporeda rada/noćne redukcije.
- U hodniku, kupaonici i knjižnici nalaze se elektronički senzori temperature (art. 14432.SL) i elektronički senzori vlage (art. 14433.SL) koji nakon što ih se sučeljem spoji s hidrauličkim sustavom omogućavaju držanja prostornih parametara pod nadzorom.



Elektronički termostat sa zaslonom osjetljivim na dodir i centraliziranim gumbom za aktivaciju toplinske regulacije u komfornom načinu rada.



Elektronički senzor temperature.



Elektronički termostat sa zaslonom osjetljivim na dodir omogućava prikazivanje i temperature koju je detektirala sonda instalirana u nekoj drugoj prostoriji.



Aktivni elektronički senzor vlage.



Što učiniti:

Posjetite web-mjesto www.vimar.com, u odjeljku Podrška/Praktični video vodič/Praktični vodič/Klima kako biste pogledali praktični video vodič: "Termostat osjetljiv na dodir s 2 ugradna modula Šif. 02950".



Toplinska regulacija u tercijarnom sektoru

Primjer sustava u školi s uređajima za toplinsku regulaciju za aktivaciju zonskih ventila i elektroničkim sondama temperature i vlage sučeljem povezane sa sustavom za hidrauličku toplinsku regulaciju.

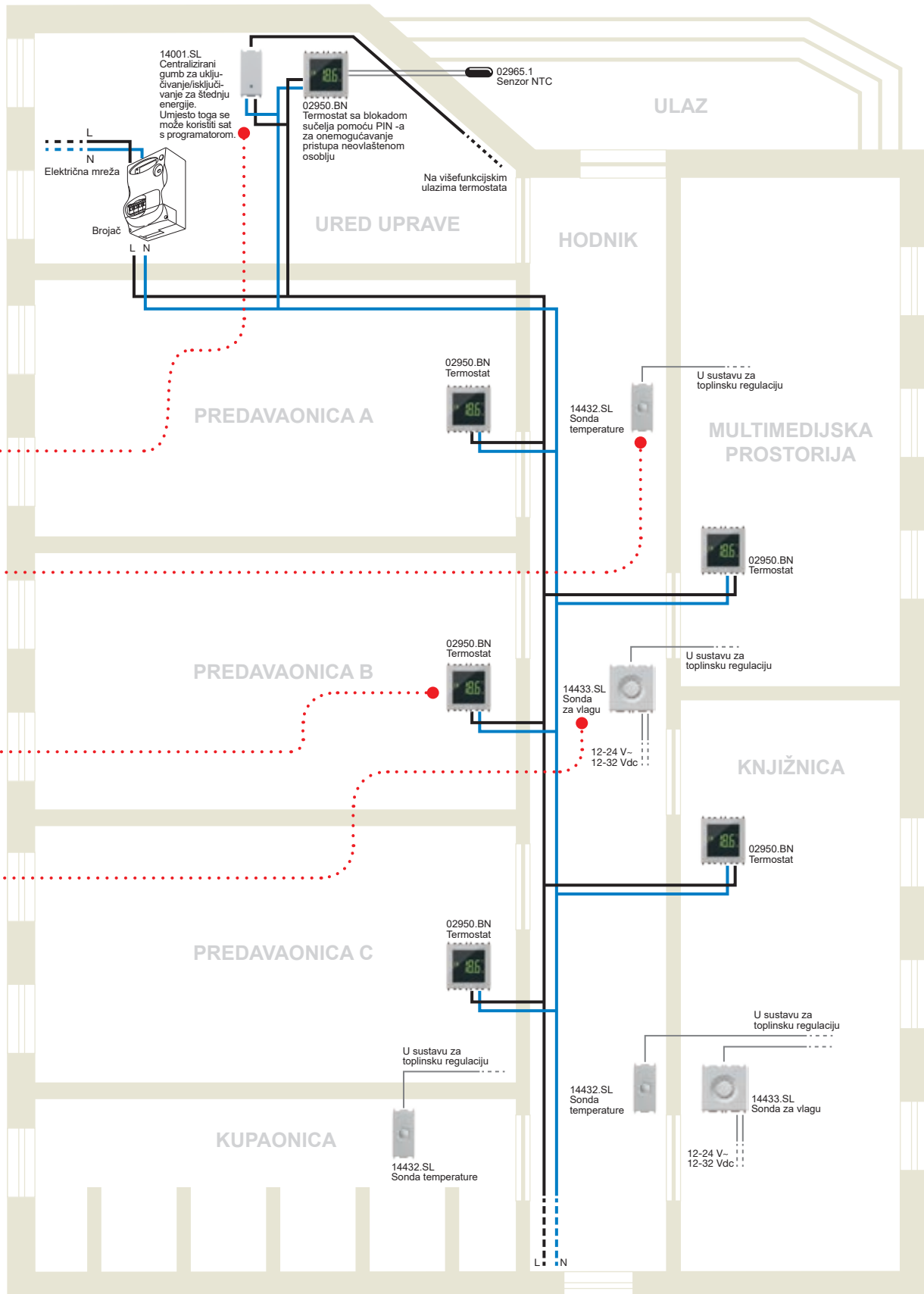

Videoportafonija u stambenom prostoru

Stan od 80 m² s videoportafonskim sustavom.

Vimar nudi široku lepezu uređaja za videoportafonski sustav Due Fili Plus koordiniranih sa serijom proizvoda Eikon, Arké i Plana. Video zaslon osjetljiv na dodir od 10" i 4,3", osim što ima funkciju videoportafona, namijenjen je i za napredne funkcije koje je moguće integrirati u eventualno postojeći domotički sustav By-me.

U primjeru se ilustrira sustav videoportafonije Due Fili Plus u stanu od 80 m² s vanjskom pločicom i dva interna videoportafonska mjesta.

- U dnevni boravak ugrađen je video zaslon u boji osjetljiv na dodir veličine 4,3" 21554.B koji, osim što prikazuje vanjski

poziv ili omogućava komuniciranje putem pozivnog gumba na stubištu, omogućava otvaranje električne brave ili paljenje svjetla iznad stuba.

- U kuhinji se nalazi drugi video zaslon u boji osjetljiv na dodir veličine 4,3" 21554.B.
- Iz sobe je moguće odgovoriti na vanjski poziv, otvoriti vrata ili upaliti svjetla iznad stuba putem ugradbenog portafona za razgovor uživo 14557 s 3 modula.
- Na stubište je postavljen pozivni gumb 14577.



Video zaslon u boji osjetljiv na dodir veličine 4,3" Full Flat* s prikazom "videopoziva".



Portafon za razgovor uživo.



Pozivni gumb.

Što učiniti:

Za više detalja o instalaciji i konfiguraciji uređaja pogledajte dokumentaciju dostupnu na web-mjestu www.vimar.com u odjeljku Proizvodi.



Videoportafonija u stambenom prostoru

Tipični sustav: stan od 80 m² s videoportafonskim sustavom.

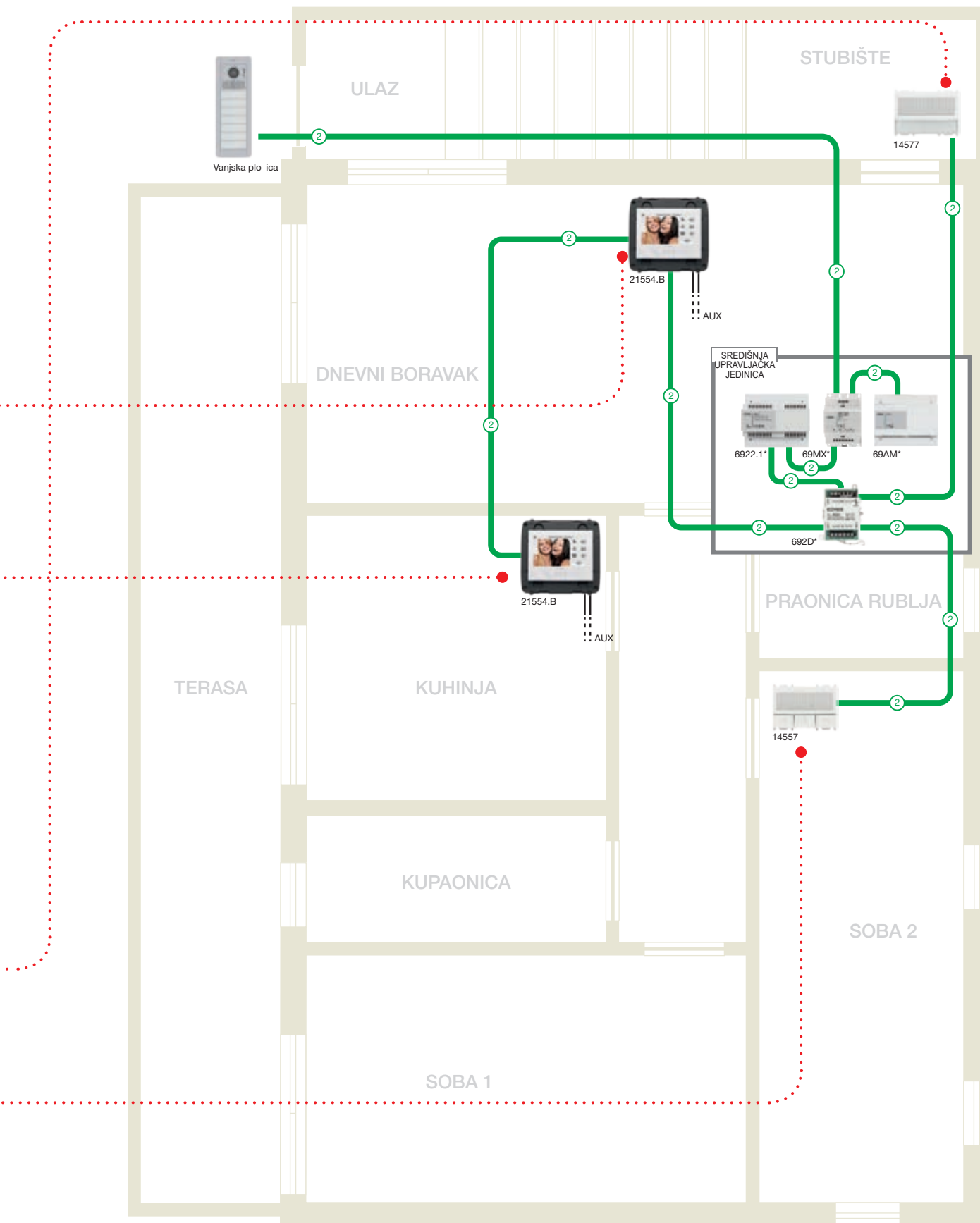

*Za više detalja pogledajte katalog Due Fili Plus Elvox.



Stan od 80 m² s radiofrekvencijskim komandama EnOcean za upravljanje svjetlima ili generičkim trošilima.

Radiofrekvencijski uređaji EnOcean idealni su za dodavanje komandnih funkcija i aktivaciju novih ili postojećih sustava bez interveniranja putem zidarskih radova.

U novim sustavima, za primjenu na materijalima na kojima bi bilo teško, ako ne i nemoguće, pristupiti postavljanju s ugradbenom kutijom (od stakla, drva, armiranog cementa) ili na strukture na kojima nije nužno zadržati cjelovitu strukturu kako bi se sačuvala toplinska izolacija kakvu zahtijeva moderna gradnja.

U postojećim sustavima, zbog nedostatka preduvjeta ili zbog arhitektonskih ograničenja povijesnih zdanja.

Prednosti koje se ostvaruju primjenom uređaja tvrtke Vimar s tehnologijom EnOcean:

- nikakva interferencija radio signala niti u prijemu niti u prijenosu zahvaljujući protokolu i niskoj elektromagnetskoj emisiji (najnižoj među svim radijskim tehnologijama trenutno dostupnim na tržištu);
- nije potrebno nikakvo održavanje komandi zbog zamjene baterija: komande rade bez baterija, koristeći energiju koja se stvara pritiskom na tipku;
- svaka pojedinačna komanda namijenjena je za kontrolu dvaju nezavisnih električnih trošila;
- estetska koordinacija komandi s linijama Eikon, Arké, Plana;
- mogućnost postavljanja bilo na glatkim površinama putem

odgovarajućih nosača, bilo putem ugradbenih kutija na standardnim nosačima;

- aktivator može raditi i kao repetitor primajući signal iz komande i prenoseći ga drugom aktivatoru za kojeg je konfiguriran;
- aktivator može raditi i kao diverter za mješoviti žično-radiofrekvencijski sustav.

Primjer prikazuje postavljanje uređaja EnOcean u stanu u kojem je moguće naređivati uključivanje/isključivanje trošila, s komandama 03955 i aktivatorima 01796.1:

- putem jedne jedine komande na ulazu upravlja se trima svjetlima u dnevnom boravku, kuhinji i hodniku, stvarajući na taj način scenarije Ulaz i Izlaz. U stvari, aktivator u dnevnom boravku je konfiguriran i kao repetitor signala za aktivator u kuhinji, a on, sa svoje strane, kao repetitor za aktivator u hodniku;
- Wi-Fi pristupna točka smještena u radnoj sobi aktivira se putem radiofrekvencijske komande smještene iznad pisaćeg stola;
- u sobi se svjetlom upravlja putem dva divertera, jednog pretvarača i jednom radiofrekvencijskom komandom EnOcean ugrađenom u žični sustav;
- uvijek u sobi je postavljena komanda koja komunicira s aktivatorom EnOcean zbog aktiviranja LED trake unutar kabine ormara.



Radiofrekvencijska komanda Plana Silver s konfiguracijom scenarija za Ulaz/Izlaz.



Radiofrekvencijska komanda Plana Silver za uključivanje/isključivanje i regulaciju intenziteta svjetla u dnevnom boravku



Radiofrekvencijska komanda Plana Silver za uključivanje/isključivanje pristupne Wi-Fi točke i regulaciju svjetla.

Što učiniti:

Tipka osjetljiva na dodir (gumb za usklađivanje). Držanjem pritisnutom tipke u trajanju od 8 s aktivator ulazi u fazu učenja signalizirajući takvo stanje isprekidanom komutacijom relejnog izlaza. Kada se pritisne komandna tipka 03955 ona se memorira i ostaje aktivna nekoliko sekundi, a zatim nastavlja s komutacijom; pritiskom na tipku osjetljivu na dodir ili nakon približno 15 s neaktivnosti, aktivator izlazi iz faze učenja.

Konfiguriranje aktivatora kao repetitora. Držite pritisnutom tipku osjetljivu na dodir u trajanju od 15 s, a zatim je pustite; odaberite tip repetitora (način rada 2 ili način rada 3) ponovljenim pritiskom tipke osjetljive na dodir potvrdite postavku dodatnim pritiskom na tipku u trajanju od 5 s.

Brisanje memorije. Pritiskom na tipku osjetljivu na dodir u trajanju od 12 s brišu se sva izvršena memoriranja, a aktivator ulazi izravno u fazu učenja (pogledajte prethodnu točku). Aktivator s modulom EnOcean može primiti radio signal putem naredbe prenesene iz jedne tipke EnOcean (03955) a putem relejnog izlaza, dati naredbu trošilu s kojim je povezan. U slučaju nestanka mrežnog napona, aktivator zadržava prethodno izvršenu konfiguraciju.



Aktivator s modulom EnOcean

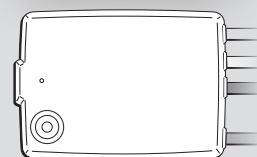

Tipka osjetljiva na dodir na poleđini uređaja.

PRIMJERI INSTALACIJE



Rješenje radio EnOcean



Tipični sustav: stan od 80 m² s radiofrekvencijskim komandama EnOcean za upravljanje svjetlima i generičkim trošilima.

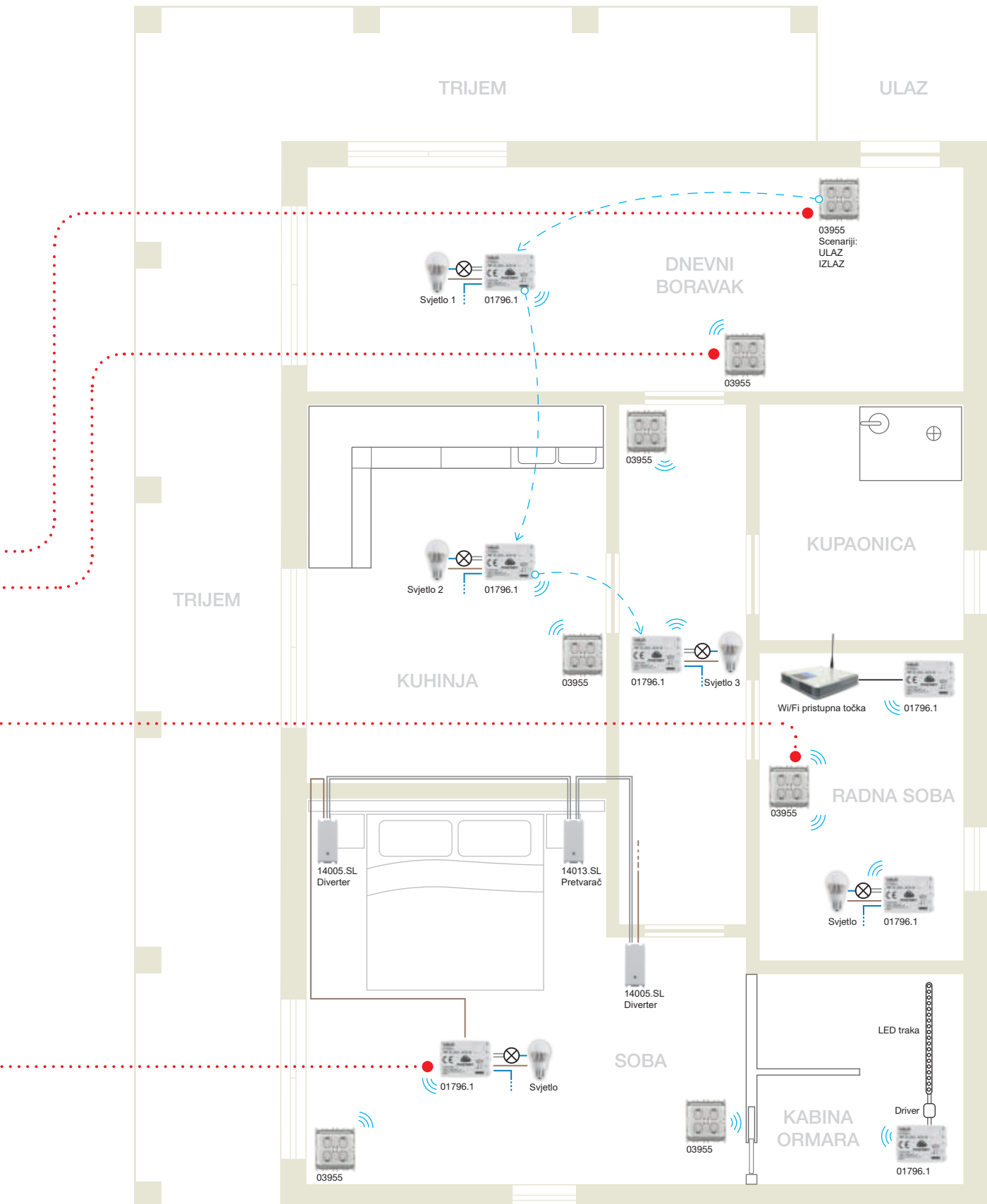

Dućan od 80 m² s radiofrekvencijskim komandama ZigBee za upravljanje svjetlima.

U profesionalnom okruženju (uredi, dvorane za sastanke, hodnici i prostori na otvorenom), a katkad i u stambenom okruženju, sve su raširenija tehnološka rasvjetna rješenja koja potiču štednju energije, zahvaljujući primjeni senzora prisutnosti i osvjetljenosti koji mogu utjecati kako na aktivaciju svjetla tako i na regulaciju njegove jačine. S ciljem smanjenja troškova postavljanja, katkad se zbog restrukturiranja i zbog novih sustava pribjegava bežičnim rješenjima koja smanjuju korištenje kabela i žica, a vremena instalacije se prilagođavanju eventualnim budućim preinakama.

Među raznim tehnologijama koje omogućuju zadovoljavanje tih potreba postoji ZigBee, novi protokol za upravljanje rasvjetom koji se brzo širi, zahvaljujući i usklađenosti s tehnikama žetve energije (engl. energy harvesting) s mehanizmima za generiranje energije bez upotrebe baterije.

Ta **radio komanda, certifikat ZigBee Green Power**, može prenositi signal iskorištavajući energiju koja se generira pritiskom na tipke, dakle nisu joj potrebne baterije koje se moraju mijenjati ili odlagati na otpad.

S obzirom na to da je njezino obilježje minimalno izbočenje, komanda djeluje u koordinaciji s modernim dizajnom asortimana Arké i savršeno se spaja sa stilom prostora, kakav god on bio i predstavlja idealno rješenje za svakoga tko je u potrazi za

praktičnošću, slobodom postavljanja i univerzalnošću: ovaj se uređaj može postaviti svugdje, čak i na površine od stakla ili drva. Sve to bez potrebe za interveniranje putem zidarskih radova, zato jer mu nisu potrebne ugradbene kutije.

Ta **komanda je kompatibilna** s ostalim proizvodima koji na sebi imaju oznaku "Works with EasyAir", što znači da **se može koristiti u kombinaciji sa sensorima/radio aktivatorima EasyAir** (ugrađenim u mnoge profesionalne aparate prisutne na tržištu), na primjer za aplikacije u kojima jedna svjetiljka ili skupina svjetiljki moraju reagirati u slučaju pokreta ili u slučaju varijacija jačine svjetla.

Nakon uparivanja s aktivatorima koji upravljaju žaruljama, na komandi su odmah dostupne funkcije uključivanja/isključivanja i regulacije jačine svjetla (lijeva tipka) i pozivanja dvaju scenarija osvjetljenja prethodno definiranih na aktivatorima/prijamnicima (desna tipka).

Komanda se može upotpuniti tipkama od 1 modula za iskorištenje svih dostupnih funkcija ili s tipkama s 2 modula ograničavajući upravljanje samo na uključivanje/isključivanje (i regulaciju jačine osvjetljenja) ili na pozivanje dvaju scenarija.



Radiofrekvencijska komanda Plana upravljanje svjetlima u dva izloga.



Radiofrekvencijska komanda Plana za kontrolu svjetala u zoni izlaganja i aktiviranja scenarija.

Što učiniti:

Za više detalja o instalaciji i konfiguraciji uređaja pogledajte dokumentaciju dostupnu na web-mjestu www.vimar.com u odjeljku Proizvodi.



Rješenje radio ZigBee u tercijskom sektoru

Tipičan sustav: dućan od 80 m² s radiofrekvencijskim komandama ZigBee za upravljanje svjetlima pomoću senzora aktivatora/prijamnika EasyAir (dijelovi nezavisnih proizvođača).

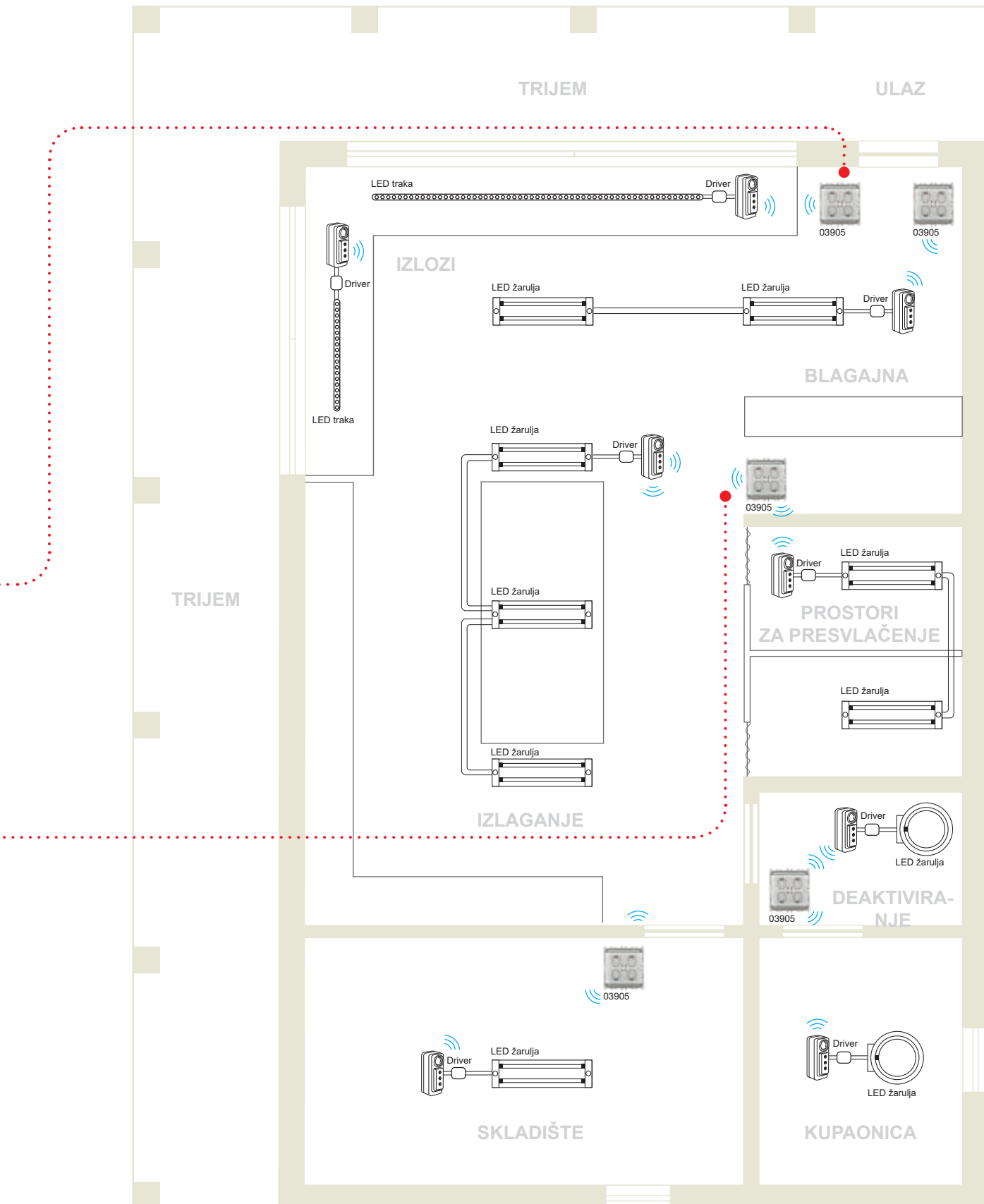

Kontrola ulaza za tercijarne aplikacije

Seosko gospodarstvo sa samostalnim sustavom kontrole ulaza.

Samostalni sustav kontrole ulaza je temeljno rješenje za prijamne strukture (mala seoska gospodarstva, hosteli za mladež itd.) koji zahtijevaju ograničene funkcije.

U ovom rješenju otvaranje vrata/električnih brava provodi se izravno putem releja montiranog na čitač/programator.

Releji može raditi na 3 različita načina:

1. impulsni (tempirani monostabilni-flash način rada): unos pametne kartice uzrokuje zatvaranje kontakta releja u trajanju oko 3 sekunde;
2. korak po korak (bistabilni-toggle mode): unos pametne kartice uzrokuje komutaciju releja prema cikličkom slijedu otvoreni kontakt/zatvoreni kontakt;

3. kao elektronički prekidač: unos pametne kartice uzrokuje zatvaranje kontakta releja; do otvaranja dolazi nakon vađenja same pametne kartice (moguće je birati između otvaranja s odgodom od 50 s i trenutnog otvaranja).

Primjer ilustrira sljedeće:

- čitače pametne kartice 14461.SL instalirane izvan prostorija koji otvaraju vrata (električnu bravu) nakon umetanja omogućene kartice;
- prekidači s okomitim utorom 14465.SL instalirani unutar soba koji aktiviraju trošila (svjetla i strujne utičnice) nakon umetanja pametne kartice koju je dobio gost.



Prekidač s okomitim utorom s umetnutom pametnom karticom.



Čitač pametne kartice.

Što učiniti:

Konfiguracija ulaza može se realizirati na 2 načina:

1. bez pametne kartice MASTER (1 razina): bilo kakva operacija (inicijalizacija, kodificiranje, dupliciranje, brisanje, promjena šifre, sinkronizacija čitača) može se izvršiti pomoću svih osposobljenih pametnih kartica.
2. s pametnom karticom MASTER (2 razine) - da bi bilo kakva operacija (inicijalizacija, kodificiranje, dupliciranje, brisanje, promjena šifre, sinkronizacija čitača) bila izvršena, nužna je primjena kodificirane pametne kartice MASTER.

Pametna kartica je elektronički ključ koji na 15 razdvojenih adresa može memorirati isto toliko slučajno generiranih šifara, u trenutku programiranja, između 4,29 milijardi kombinacija za svaku od njih. Korištenjem 4 dip prekidača koji se nalaze na poleđini čitača/programatora moguće je odabrati željenu adresu i doista konfigurirati ulaske u prostore. Time se pametnoj kartici omogućava uparivanje s 15 različitih adresa (ili ulaza). Više čitača može imati istu adresu i istu šifru: u tom je slučaju se može omogućiti više ulaza uz korištenje jedne jedine adrese.

Za više informacija pogledajte priručnik u članku 16461.



Pametna kartica

PRIMJERI INSTALACIJE

Kontrola ulaza za tercijarne aplikacije

Tipični sustav: seosko gospodarstvo sa samostalnim sustavom kontrole ulaza.

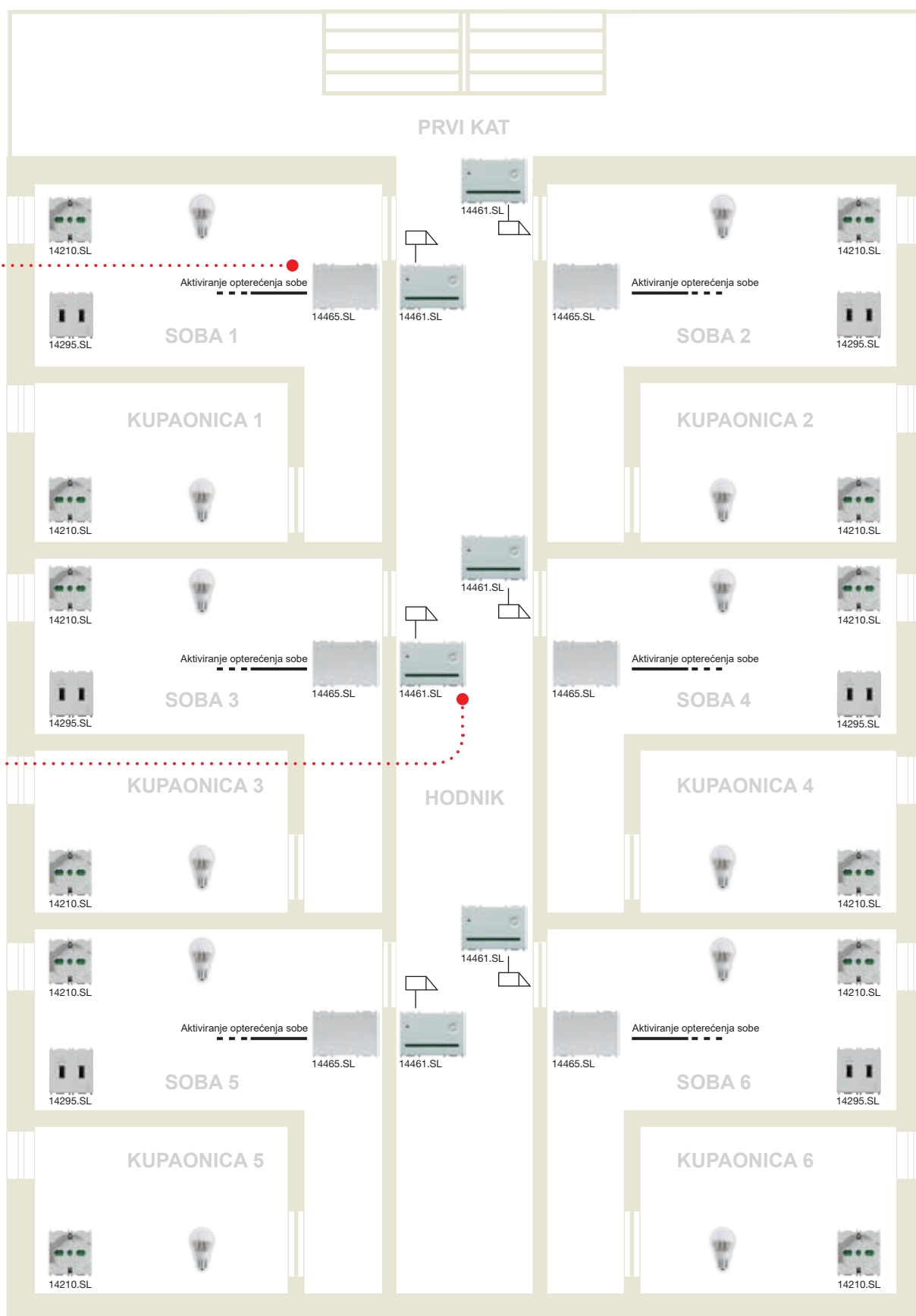

Distribucija podataka i multimedijalnost

Trgovinski ured sa sustavom za distribuciju podataka i multimedijalnim utičnicama.

Vimar nudi široki spektar signalnih utičnica za prijenos podataka bilo putem bakrenih mreža bilo putem optičkih vlakana, kao i telefonske utičnice, utičnice za TV, FM, SAT, USB, RCA i HDMI u koordinaciji s proizvodima serija Eikon, Arké, Idea i Plana.

Netsafe je sustav strukturiranog polaganja kabela tvrtke Vimar za mrežno povezivanje (Kat. 5e, kat. 6 i kat. 6A oklopljene i neoklopljene) cijelog zdanja.

Primjer prikazuje sustav za distribuciju podataka i multimedijalne utičnice unutar trgovinske strukture s tri ureda, multimedijalnom dvoranom, dvoranom za sastanke i recepcijom.

- Na recepciji se nalazi podatkovna utičnica za spajanje osobnog računala na mrežu, podatkovna utičnica RJ45, telefonska utičnica i strujna USB utičnica za punjenje elektroničkih uređaja.
- S recepcije se ulazi u tehnički lokal u kojem je instaliran ugradbena kutija za distribuciju signala (QDSA) koja prebacuje

podatkovnu mrežu zgrade u jednu jedinicu i sadrži pristupnu Wi-Fi točku.

- Ovdje se nalazi i ormar Netsafe koji sadrži permutacijske ploče za distribuciju raznih podatkovnih signala.
- U tri ureda predviđena su od dva do četiri radna mjesta s odgovarajućim podatkovnim utičnicama, HDMI utičnicom i jednom Wi-Fi pristupnom točkom.
- U multimedijalnu dvoranu postavljena su 2 ugradbena razglasa s 8 modula (4+4) i 2 konektora za dodatne razglase, podatkovne, telefonske, HDMI, RCA, VGA i TV-SAT-FM utičnice za spajanje uređaja Hi-Fi ili za video projekciju, jedna USB utičnica za punjenje pametnog telefona i tableta i jedna pristupna Wi-Fi točka.
- Dvorana za sastanke opremljena je podatkovnim i telefonskim utičnicama za povezivanje prijenosnih računala i jedne pristupne Wi-Fi točke.



Utičnica HDMI i Wi-Fi pristupna točka.



USB utičnice, utičnica za konektor optičkih vlakana i utičnica RJ45.



Utičnica RCA i utičnica VGA.



Utičnice za razglase i utičnica TV-SAT-FM.

Što učiniti:

Za više detalja o instalaciji i konfiguraciji uređaja pogledajte dokumentaciju dostupnu na web-mjestu www.vimar.com u odjeljku Proizvodi.



PRIMJERI INSTALACIJE

Distribucija podataka i multimedijalnost

Tipični sustav: trgovinski ured sa sustavom za distribuciju podataka i multimedijalnim utičnicama.

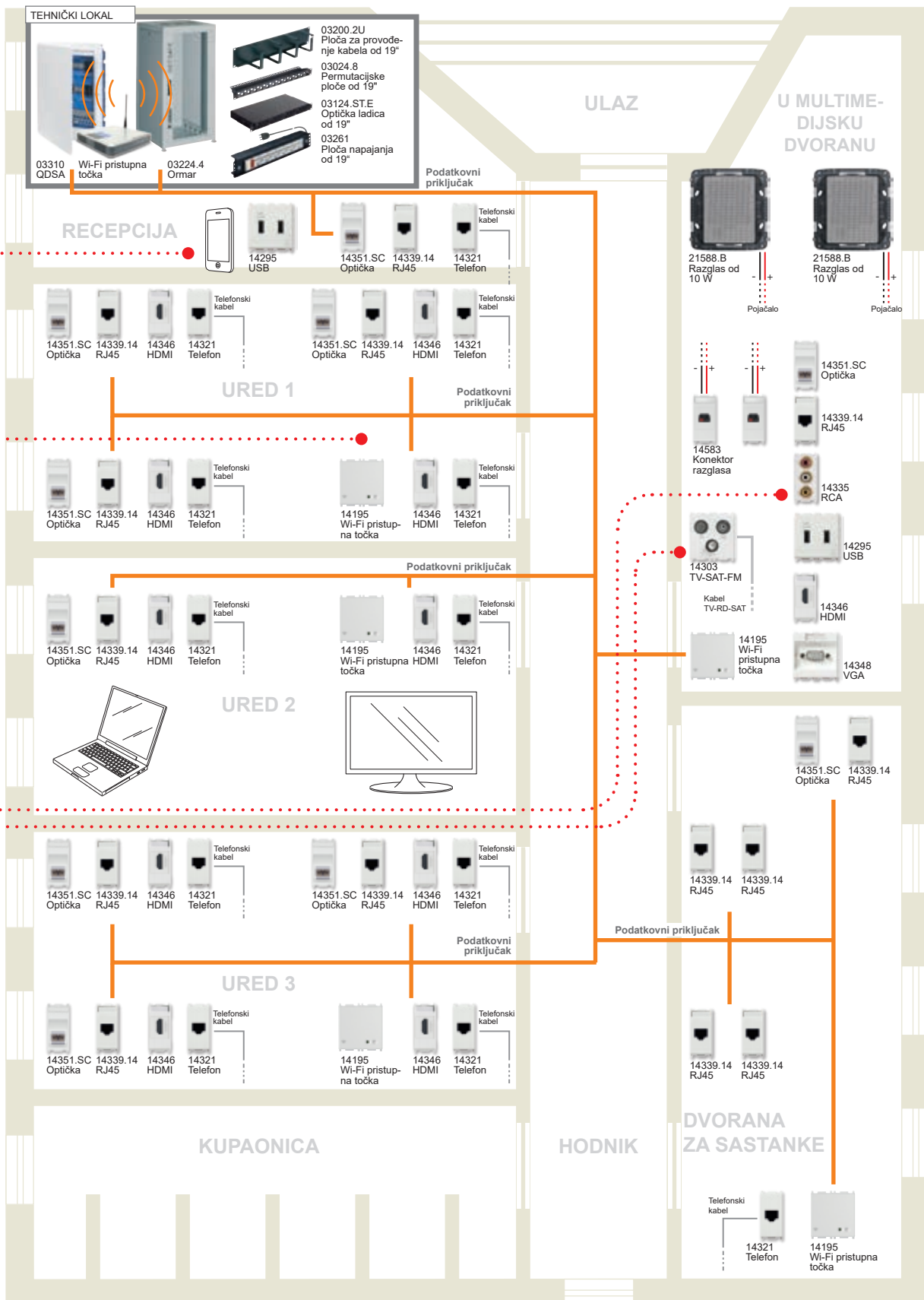

Osnovna domotika po načelu Plug&Play

Stan s jednim osnovnim domotičkim sustavom Plug&Play za upravljanje svjetlima i roletama.



Vimar predlaže inteligentna rješenja za valoriziranje doma: unaprijed konfigurirane uređaje, kojima nije potrebna nikakvo specifično programiranje i koji dozvoljavaju da se tradicionalni sustav preobrazi u mali domotički sustav namijenjen upravljanju svjetlima i roletama; moguće ih je instalirati u sustavima sa „zvjezdastim središtem“ ili „raspodijeljenim“, u postojećim prostorima ili u fazi restrukturiranja stambenih i malih tercijarnih objekata.

Upravo zahvaljujući njihovoj univerzalnosti moguće ih je integrirati u najnapredniji domotički sustav By-me. Dostupni su za instalaciju na vodilicu DIN (60715 TH35) ili ugradno, ti uređaji imaju unaprijed programirane ulaze i izlaze koji aktiviraju razne funkcije upravljanja svjetlima i roletama.

Prednosti koje proizlaze iz korištenja domotike Plug&Play su višestruke:

- **jednostavnost instalacije:** za uređaje nije potrebna osobita stručnost, potrebno je povezati gumbe s ulazima i trošila s izlazima;
- **jednostavnost aktivacije:** prethodno konfigurirani uređaji olakšavaju posao instalatera jer ne zahtijevaju nikakvo konfiguriranje;

- **jednostavnost održavanja:** ono je brzo i provodi se iz jedne jedine točke, jer ga je moguće centralizirati na razvodnoj ploči;
- **fleksibilnost:** uređaji Plug&Play mogu se koristiti u postojećim sustavima ili u fazi restrukturiranja, od stambenih objekata do malih tercijarnih objekata;
- **skalabilnost:** osmišljeni su za osnovno upravljanje svjetlima i roletama ali ih je moguće integrirati u domotički sustav By-me radi proširivanja funkcija sustava.

Na primjeru je prikazan stan u kojem je izvršena instalacija iz razvodne ploče s dva uređaja za vodilicu DIN (60715 TH35) (art. 01470), prvi je konfiguriran za upravljanje s 8 svjetala (u kuhinji, hodniku, sobama i kupaonici), a drugi za upravljanje s 4 rolete s lamelama (u kuhinji, sobama i kupaonici).

U dnevnom boravku su instalirana tri ugradna uređaja:

- art. 01477 upravljanje jednim svjetlom s paralelnim povezivanjem dva gumba;
- art. 01476 za upravljanje roletom s lamelama;
- art. 01475 za upravljanje scenarijima „rolete GORE/DOLJE“ i „svjetla ISKLJUČENA, rolete DOLJE“.



Prekidač za komandu svjetla



Komutator za scenarije GORE/DOLJE rolete i prekidač za scenarij Svjetla ISKLJUČENA, a rolete DOLJE



Što učiniti:

Posjetite web-mjesto www.vimar.com, u odjeljku Podrška/Praktični video vodič/Praktični vodič/Praktični vodič za gledanje praktičnog video vodiča:
“Domotika Plug&Play - Puštanje u rad uređaja koji su unaprijed konfigurirani za osnovne funkcije svjetala/roleta sa scenarijem Opće ISKLJUČIVANJE”.



PRIMJERI INSTALACIJE

Osnovna domotika po načelu Plug&Play

Tipični sustav: stan s osnovnom domotikom po načelu Plug&Play za upravljanje svjetlima i roletama.

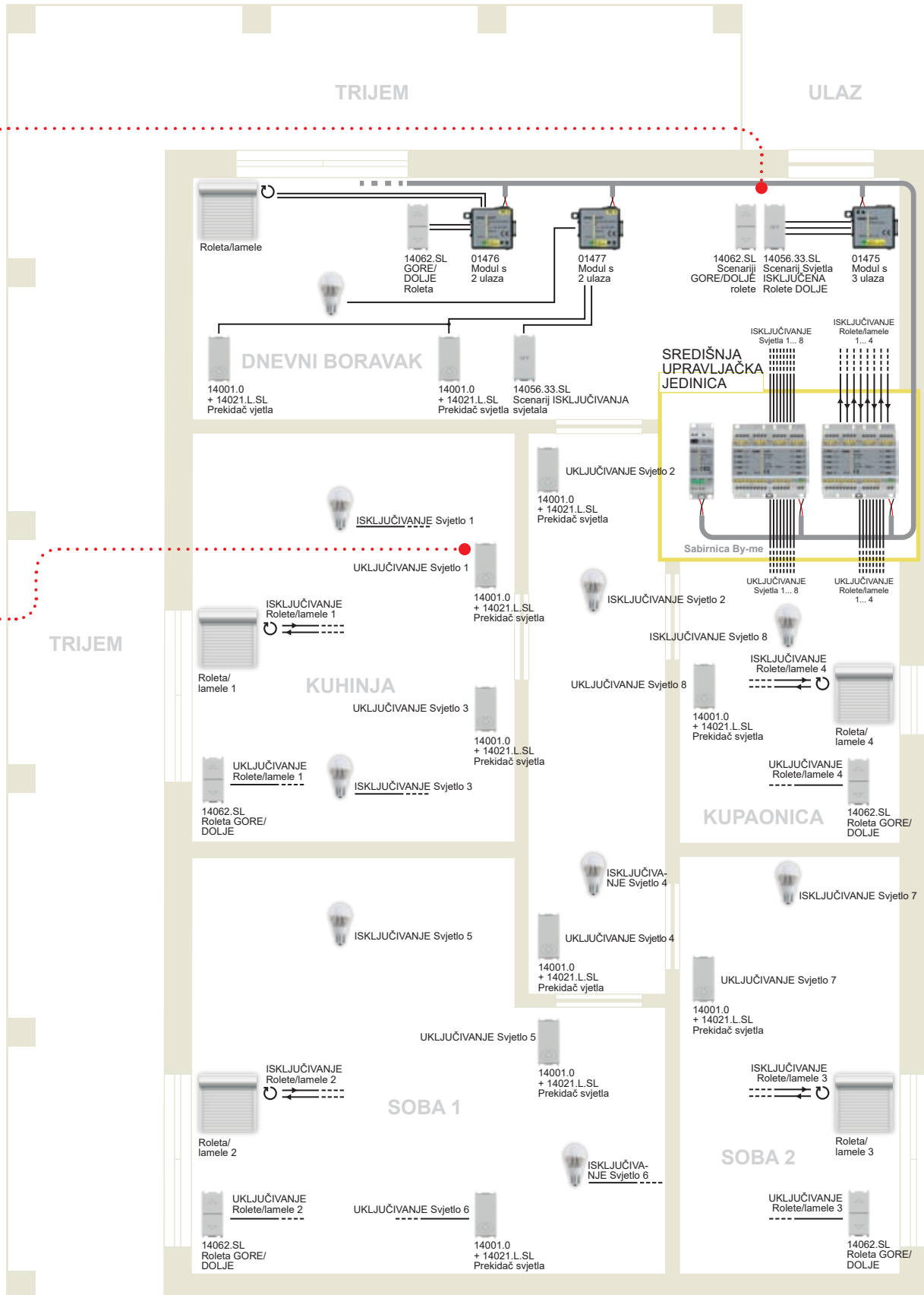

B.C18036 HR 1808



8 007352 595699



Viale Vicenza, 14
36063 Marostica VI - Italy
Tel. +39 0424 488 600
Fax +39 0424 488 709
www.vimar.com