

TEM

On | Off and everything in between



MODUL



MODUL
LINE



MODUL
SOFT



MODUL
PURE



MODUL
EDGE

50

LOGIQ



162

ekonomik



192

fontana



230



TEM

On | Off and everything in between



Smo vodilni proizvajalec stikal in vtičnic v regiji. Svojim uporabnikom že pol stoletja zagotavljamo pozitivno ter enostavno izkušnjo, hkrati pa s preprosto vgradnjo in uporabo izdelkov, širokim izborom barv in materialov, zadovoljimo še tako zahtevne želje vsakega uporabnika in prostora.

We are the leading manufacturer of switches and sockets in the region. For half a century, we have been providing our users a positive and easy experience, simple installation and use of products, a wide range of colours and materials, which convince even the most demanding.

TEM

Dobrodošli v družini **MODUL**

Welcome to the **MODUL** family

Ambientu vdahnite osebno noto in vaš slog poudarite s stikali in vtičnicami iz družine MODUL.

Give your ambience a personal touch and show off your style with switches and sockets from MODUL family.

odkrivamo nove poglede

discovering new insights



MODUL

LINE



MODUL

SOFT



MODUL

PURE



MODUL

EDGE

1

2

MODUL

LINE



MODUL

SOFT



MODUL

PURE

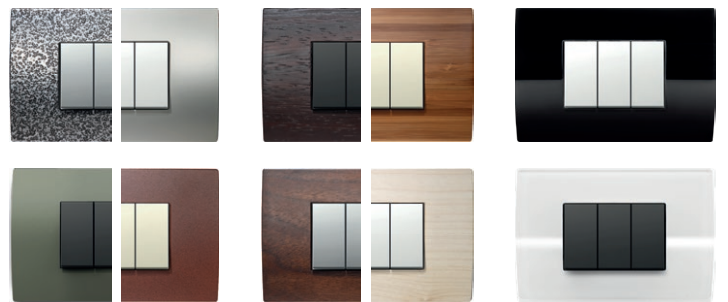

kovina

les

steklo

3

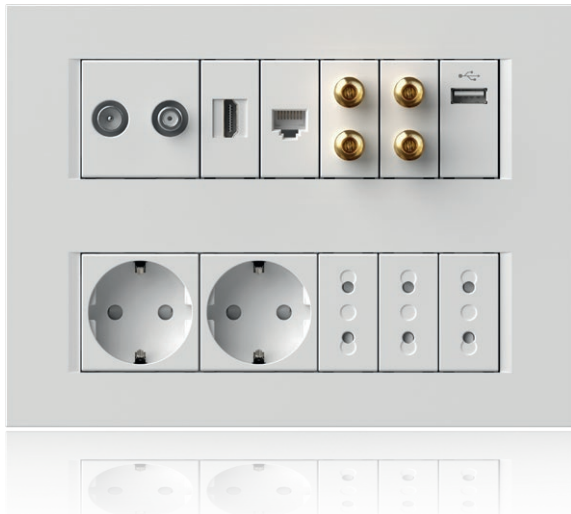

4

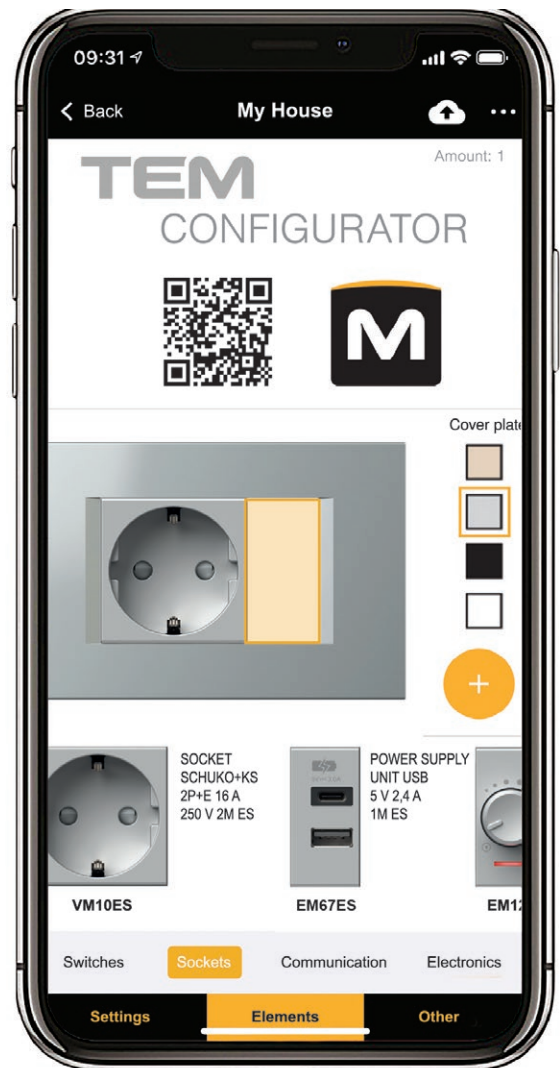

MODUL

LINE



Čiste, ravne linije ustvarjajo brezčasen dizajn.

Straight, smooth lines create a timeless design.





MODUL

LINE

PW

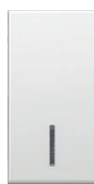

bela-sijaj

polar white

MW

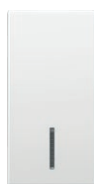

bela-mat

matte white

IW



bež-sijaj

ivory white

ES



srebrna-mat

elox silver

AT



antracit

anthracite

SB

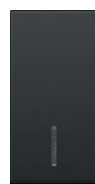

črna-mat

*soft touch
black*

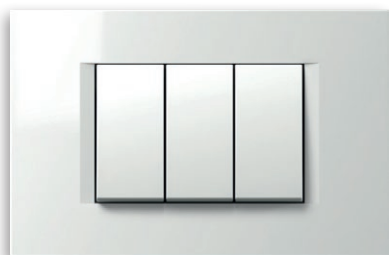

PW bela-sijaj
polar white

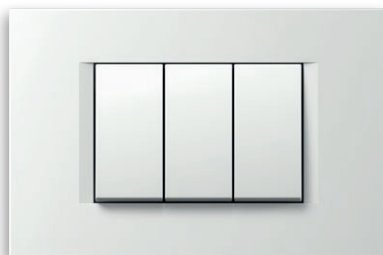

MW bela-mat
matte white

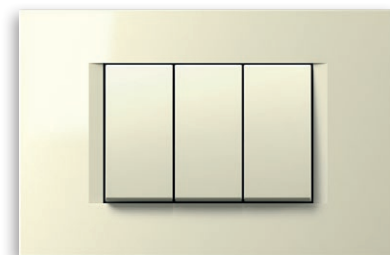

IW bež-sijaj
ivory white



SW kamen beli
stone white

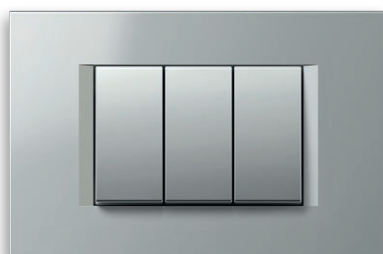

ES srebrna-mat
elox silver

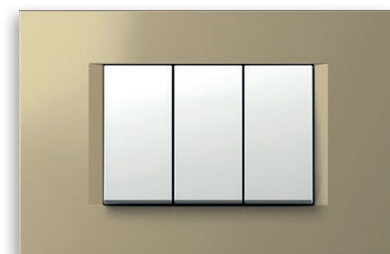

SG zlata-mat
sand gold



TI titan
titanium

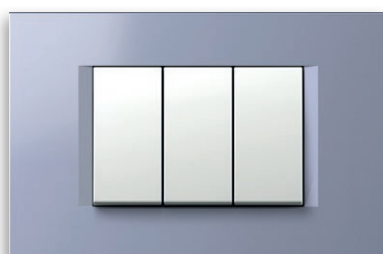

IB modra-mat
impulse blue

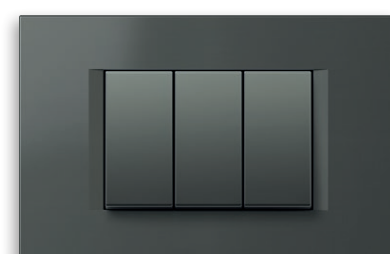

AT antracit
anthracite



NB črna-sijaj
night black



SB črna-mat
soft touch black

MODUL

SOFT

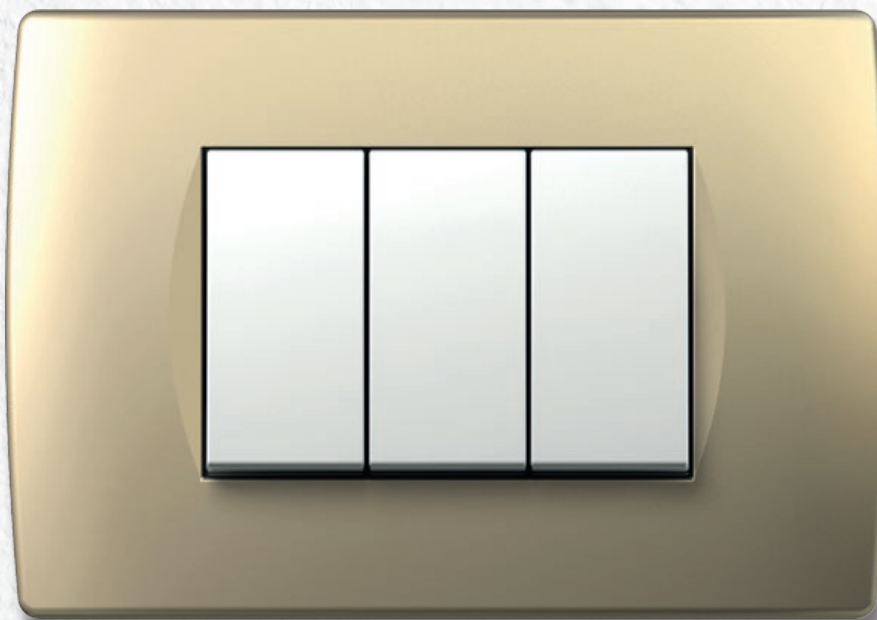

Zaobljene oblike in nežni prehodi prinesejo mehko v vaš dom.

Rounded shapes and soft transitions bring softness into your home.





MODUL

SOFT

PW

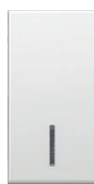

bela-sijaj

polar white

MW

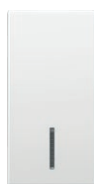

bela-mat

matte white

IW



bež-sijaj

ivory white

ES



srebrna-mat

elox silver

AT



antracit

anthracite

SB

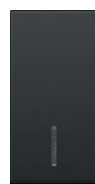

črna-mat

*soft touch
black*

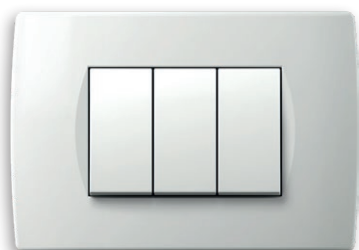

PW bela-sijaj
polar white

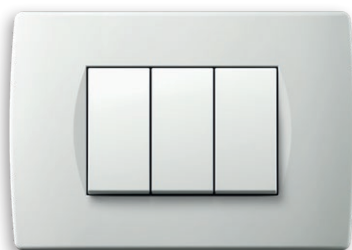

MW bela-mat
matte white

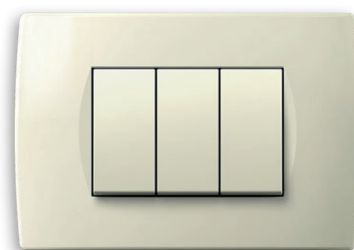

IW bež-sijaj
ivory white



ES srebrna-mat
elox silver

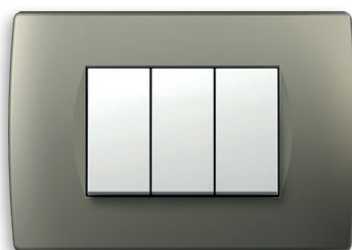

TI titan
titanium

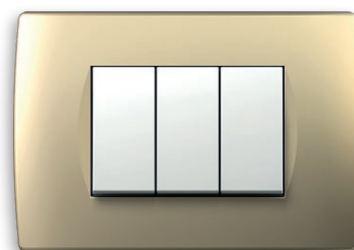

SG zlata-mat
sand gold



WW oreh
walnut



WE wenge
wenge



AT antracit
anthracite



NB črna-sijaj
night black



SB črna-mat
soft touch black

MODUL

PURE



Popolnost ambienta se skriva v podrobnostih. Dovolite naravi, da z dekorativnimi okvirji iz lesa, stekla in kovine obogati vaš prostor.

The details represent the completeness of the entire ambience. Let the nature enrich your space with decorative cover plates made of wood, glass and metal.





MODUL

PURE

PW



bela-sijaj

polar white

MW

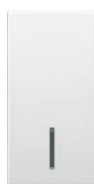

bela-mat

matte white

IW



bež-sijaj

ivory white

ES



srebrna-mat

elox silver

AT



antracit

anthracite

SB

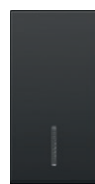

črna-mat

*soft touch
black*

steklo
glass



GL bela
glass light

kovina
metal



MH kovano jeklo
hammered steel

les
wood



WM javor
maple



GD črna
glass dark

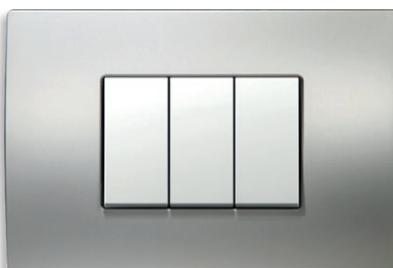

MS satinirano srebro
satın silver



WB bambus
bamboo



MN satiniran nikelj
satın nickel



WW oreh
walnut



ME zarjavelo železo
etched iron



WE wenge
wenge

MODUL

PURE



STEKLO - lahkotno in prefinjeno.
Naj svežina zaveje v vaš dom.

*GLASS - light and sophisticated.
Let freshness breeze through your home.*



steklo
glass



MODUL

PURE



KOVINA - hladna, a hkrati plemenita.
Odprite vrata prvinskosti in bodite nevsiljivo opazni.

*METAL - cold, yet noble.
Embrace this pristine material and
effortlessly catch attention.*





kovina
metal

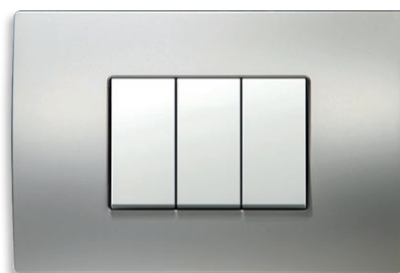

MODUL

PURE



LES - raznolik, a hkrati edinstven.
Odstrite pot toplini narave.

*WOOD - versatile, yet unique.
Give way to nature's warmth.*





les
wood

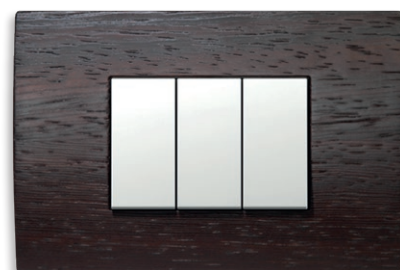

MODUL

EDGE

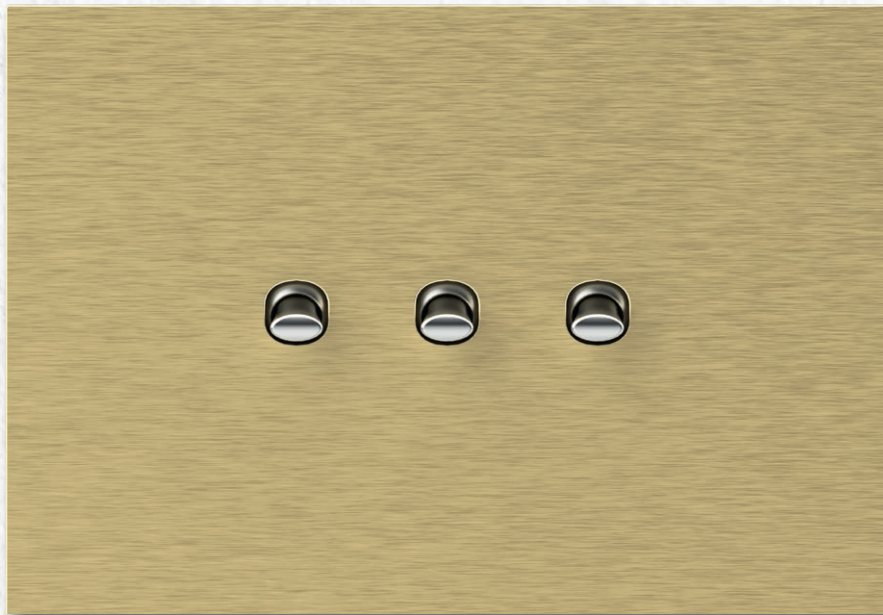

Nova prestižna linija, ki nudi posebno čutno in vizualno izkušnjo kot nikoli doslej. Si upate?

The new prestigious product line offers a special sensory and visual experience like no other before. Are you bold enough?





MODUL

EDGE

PB



črna

black

PA



antracit

anthracite

PG



zlata

gold

PC



krom

chrome

kovina
metal



MA srebrna
silver

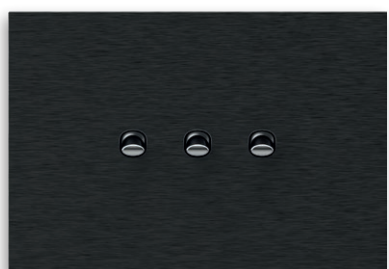

MT antracit
anthracite

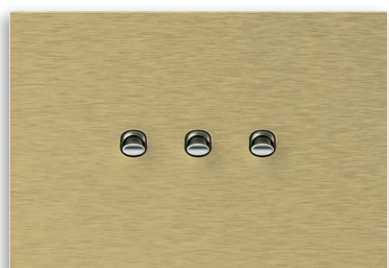

MZ zlata
gold

steklo
glass



GL bela
glass light



GD črna
glass dark

MODUL
EDGE



Čistost stekla dovoli svetlobi, da se poigra in manifestira v novih steklenih dekorativnih okvirjih EDGE. Kontrastni barvi zadovoljita še tako prefinjen okus.

The purity of the glass allows the light to playfully manifest in the new EDGE glass decorative cover plates. The two contrast colours satisfy even the most sophisticated taste.





steklo
glass



GL bela
glass light



GD črna
glass dark

MODUL
EDGE



Po zaslugi impresivne obdelave aluminij zasije v novi luči - kovinskih dekorativnih okvirjih EDGE. V treh barvnih izkušnjah, vrednih pozornosti.

Thanks to the impressive treatment, the aluminium shines with a new light – EDGE metal decorative cover plates. The three colours are worthy of your attention.





kovina
metal

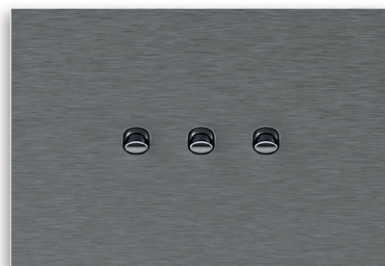

MA srebrna
silver



MT antracit
anthracite

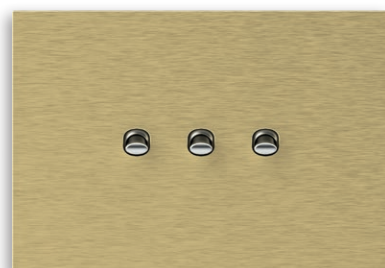

MZ zlata
gold

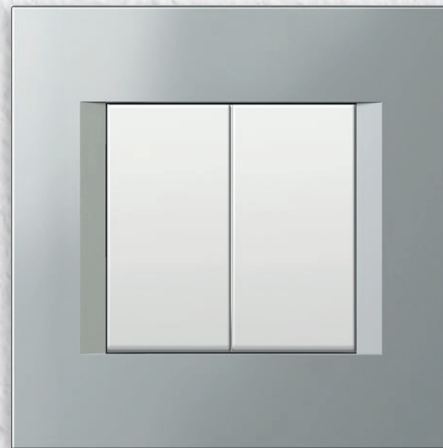

MODUL

-  LINE
-  SOFT
-  PURE
-  EDGE

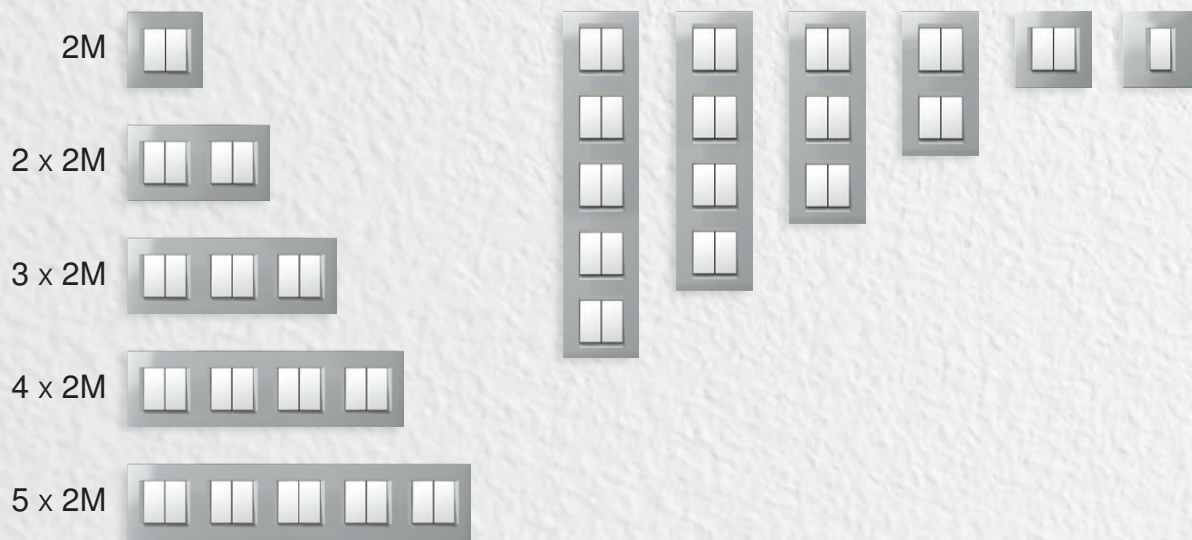
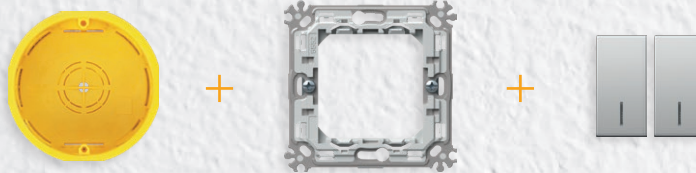

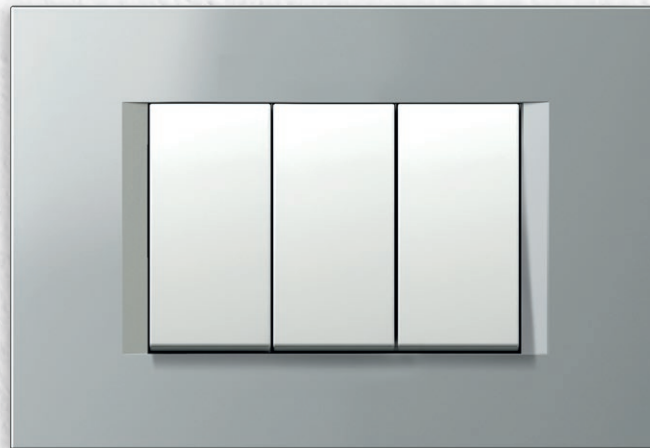

MODUL

- LINE
- SOFT
- PURE
- EDGE



2 x 7M

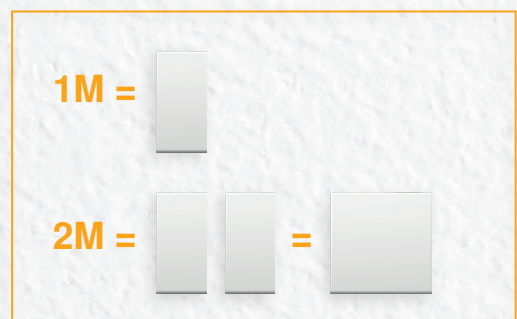

Funkcijske elemente enostavno pritrдите v nosilec. Za vas smo razvili rešitev "klik-in, klik-out", ki vam skrajša čas montaže. Priključni kontakti so lahko dostopni s sprednje strani.

The function elements are easily fitted inside the mounting frame.

The "klik-in, klik-out" solution we have developed for you will reduce installation time. The connection contacts are easily accessible from the front.

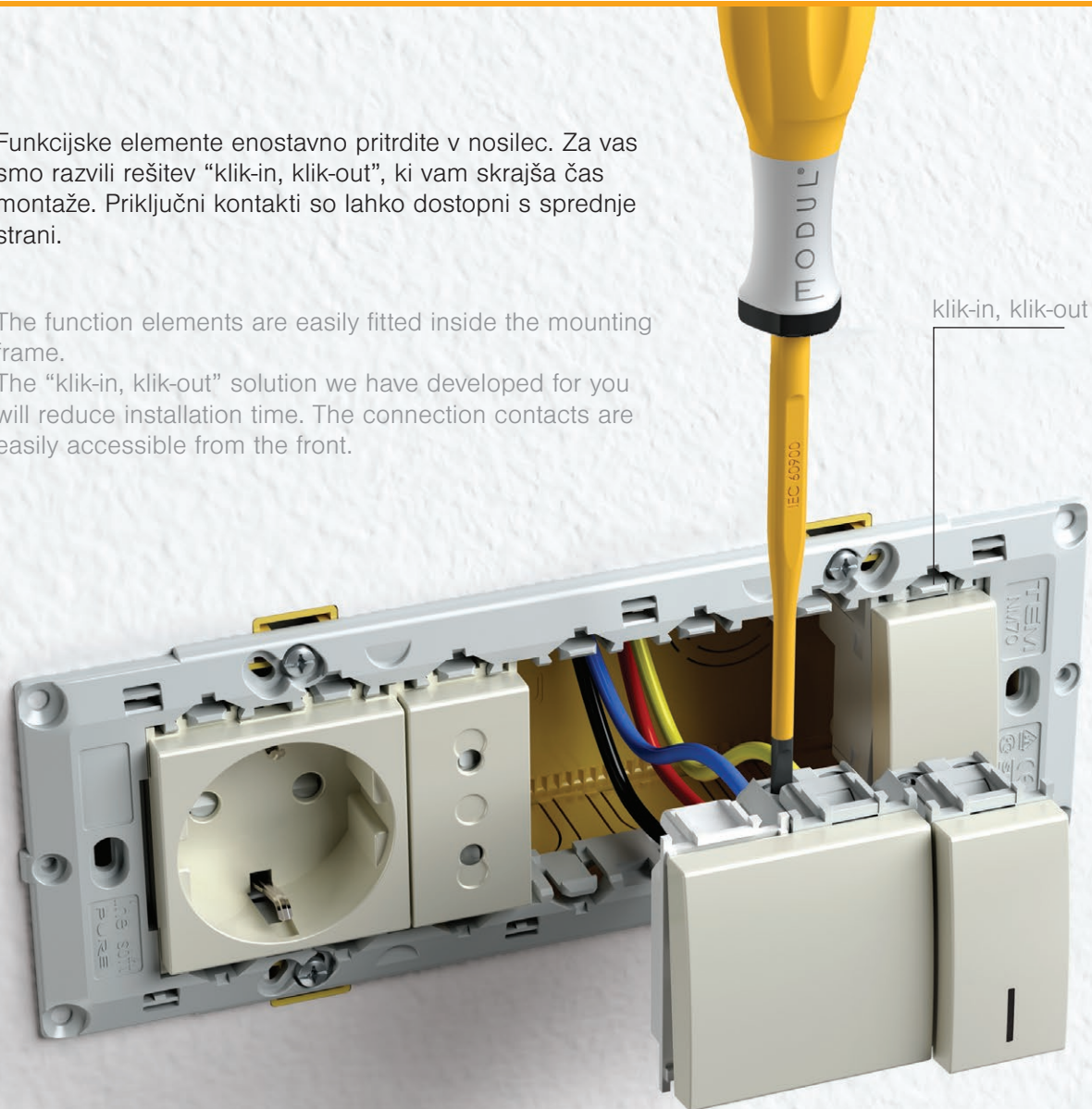

Modul lahko vgradite v katerokoli vrsto stene, naj bo klasična, suho montažna ali betonska. Vgradnja je enostavna, ponuja vam možnosti sestavljanja pravokotnih ali okroglih doz na ustrezne razdalje. Uporabljeni materiali so testirani po visokih standardih.

The Modul is suitable for all wall types and can be used in conventional, hollow wall or concrete constructions. It is easy to install and enables you to combine rectangular or round boxes at the proper distances. The materials used are compliant with high standards.



opeka / brick



votla stena / hollow wall



beton / concrete

Modul vam ponuja veliko možnosti tudi ob uporabi okroglih doz. Kombinirate lahko vodoravno ali navpično, samostojno ali v skupinah. Kovinski nosilec zagotavlja odlično stabilnost tudi pri grobi uporabi in je primeren za vse dekorativne okvirje.

The Modul enables a many possibilities even with round boxes. You can combine them horizontally or vertically, individually or in groups. The metal mounting frame ensures excellent stability even with rough use and is suitable for any decorative cover plates.

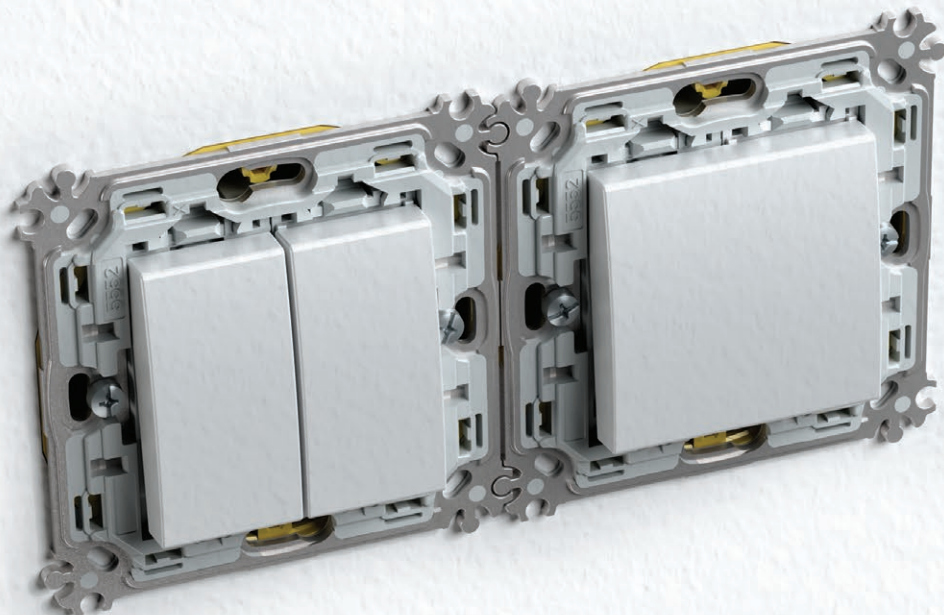



PW
bela-sijaj
polar white



MW
bela mat
matte white



SB
črna-mat
soft touch black



AT
antracit
anthracite



ES
srebrna-mat
elox silver



IW
bež-sijaj
ivory white

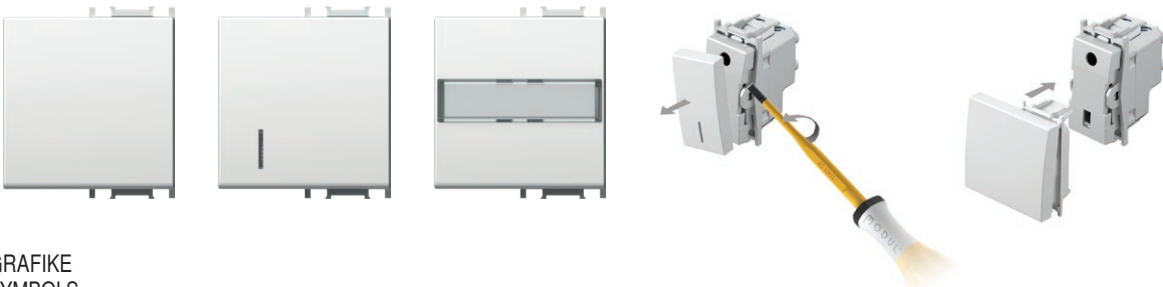

GRAFIKE SYMBOLS

| | | | | | | | | | | | | | | | |
|----|----|----|----|----|----|----|-----|----|----|----|----|----|----|----|----|
| 01 | 02 | 03 | 04 | 05 | 06 | 07 | 08 | 09 | 10 | 11 | 12 | 13 | 14 | 20 | 21 |
| | | | | | | | | | | | | | | 1 | 21 |
| 22 | 23 | 24 | 25 | 26 | 27 | 28 | 29 | 30 | 31 | 32 | 33 | 34 | 35 | 36 | 37 |
| | | | | | | | OFF | ON | | | | | AC | | |
| 38 | 39 | 40 | 41 | 42 | 43 | 44 | 45 | 46 | 47 | 48 | | | | | |
| | | | | | | | | | | | | | | | |

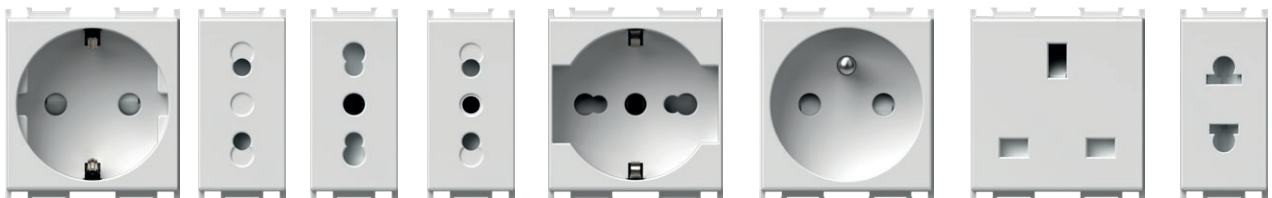

Zanesljiva priključitev vodnikov različnih premerov.

Reliable connection even when different size of wires are used.



Vse vtičnice imajo vgrajeno varovalo pred dotikom elementov pod napetostjo.

All the sockets are equipped with a safety shutters assuring the protection to live contacts.

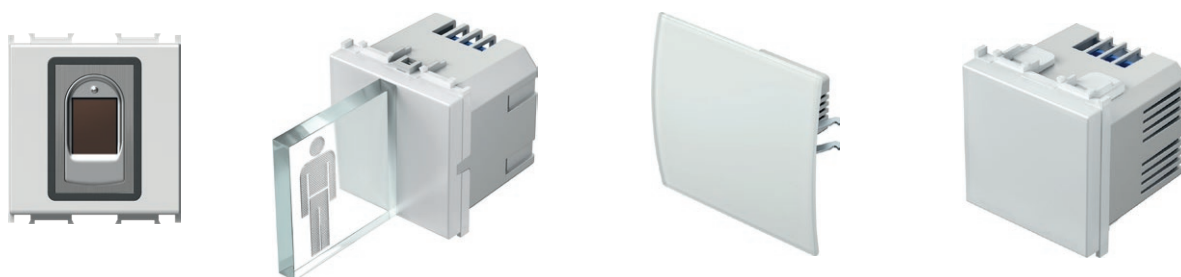
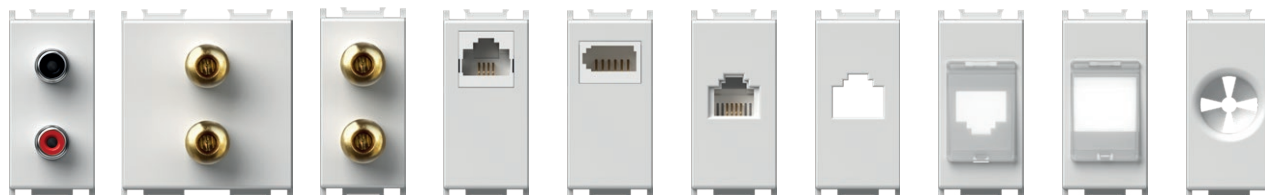

Dolga življenska doba stikal in ustreznost sodobnim standardom.

Long-life of switches and adequacy to the international standards.



Zanesljivost preklopa omogočajo srebrne kontaktne kovice.

The switch is highly reliable via its silver rivets contacts.





BIOPASS - stikalo na prstni odtis

BIOPASS - fingerprint switch

Odklepanje brez ključev.

Keyless unlocking.

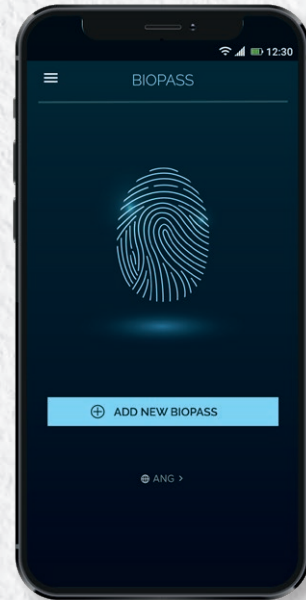

MULTIMEDIJA

MULTIMEDIA

Multimedijski center, ki vam nudi možnost priključitve več različnih komponent na enem mestu.

Multimedia center that allows you to connect a multiple number of components in one place.



OKRASI GA PO SVOJE MAKE IT UNIQUE

Izberite barvo osvetlitve in dodajte želene grafike, ki ustrezajo vašemu ambientu.

Choose a illumination colour and add desired graphic to suit the ambience of your room.



USTVARI SVOJEGA
CREATE YOUR OWN

Pri večjem naročilu naredimo okvirje in funkcijske elemente v barvi po vaših željah.

When ordering large quantities, cover plates and function elements can be made in the colour of your choice.

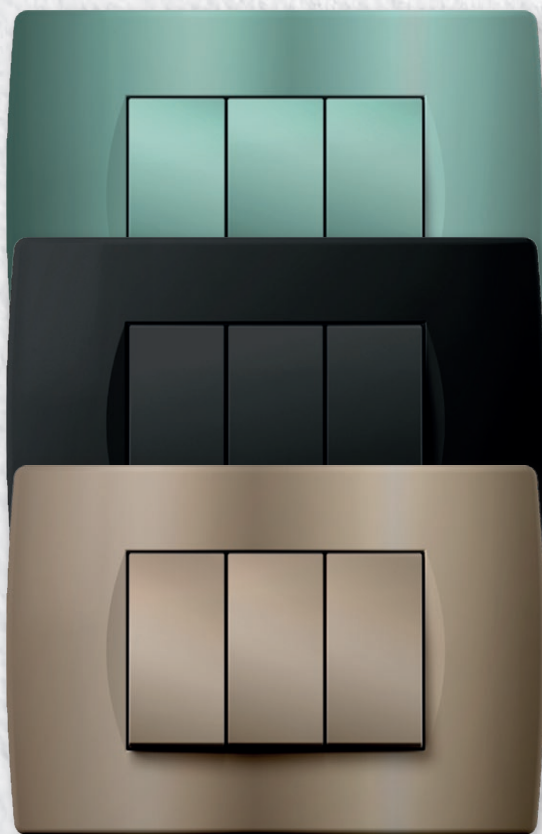



VEČOPRAVILNO ČASOVNO STIKALO

MULTIPURPOSE TIMER SWITCH

4 v 1

- časovnik
- rele
- tipkalo
- stikalo

4 in 1

- timer
- relay
- push button
- switch

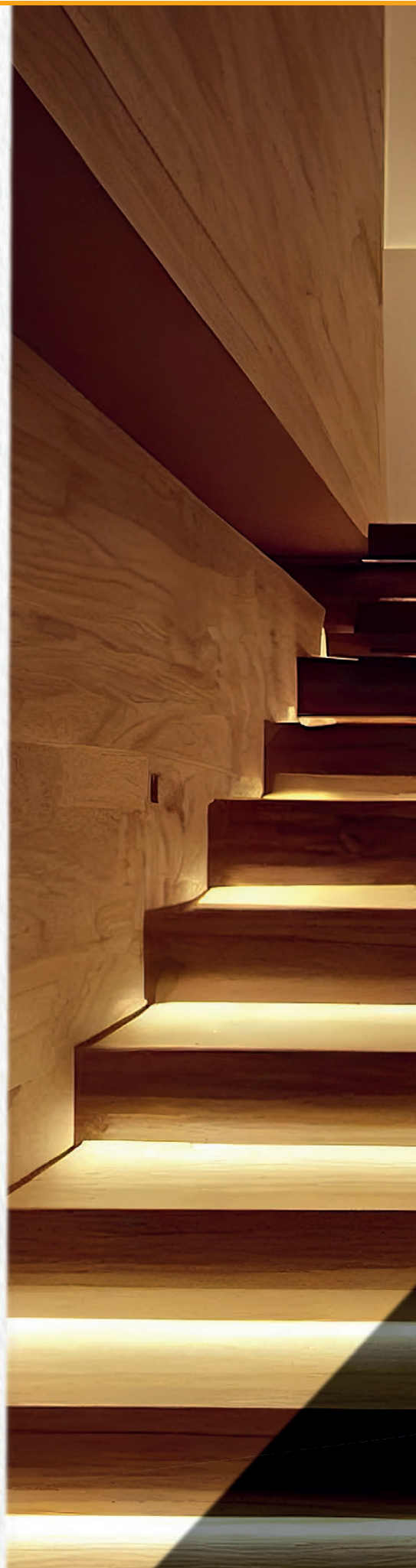

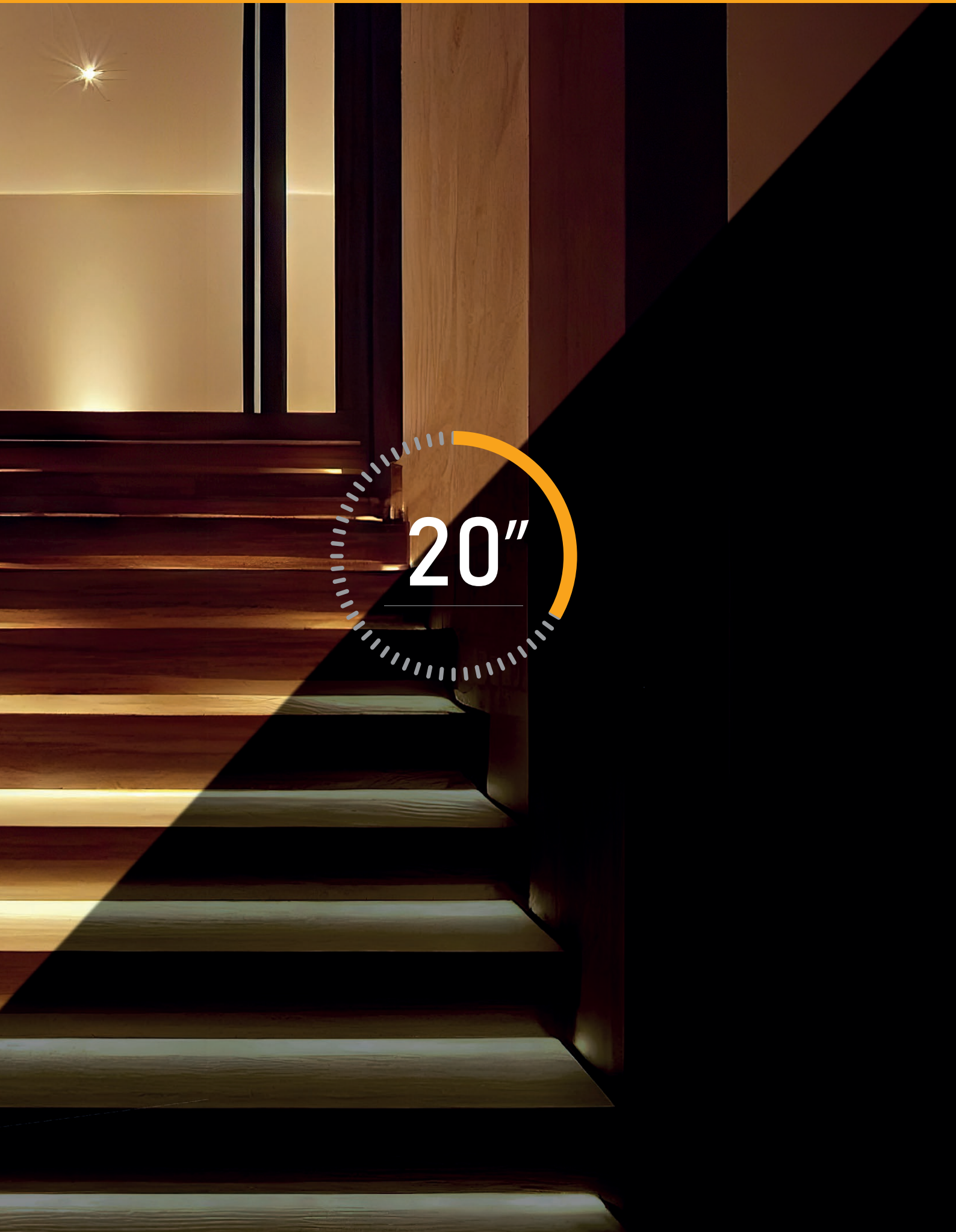

20"

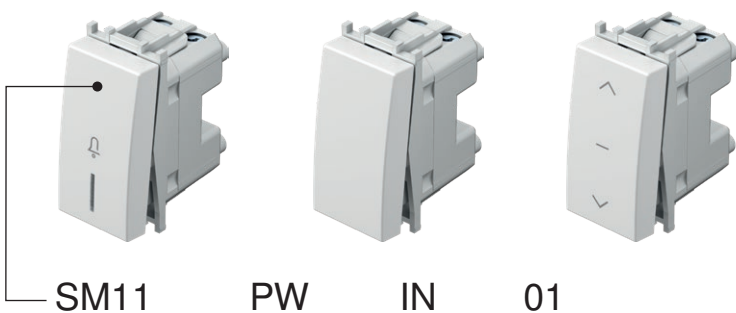

| tip type | naziv description | tehnični opis technical data | velikost size | barva colour | opcijski opis 1 optional data 1 | opcijski opis 2 optional data 2 |
|----------|-----------------------------------|------------------------------|---------------|--|---|---------------------------------|
| SM10 | STIKALO ENOPOLNO SWITCH 1WAY | 16AX 250V~ | 1M | <input type="checkbox"/> PW bela-sijaj polar white | <input type="checkbox"/> NT nevtral neutral | 01 |
| SM11 | TIPKALO ENOPOLNO PUSH BUTTON 1WAY | 16A 250V~ | 1M | <input type="checkbox"/> MW bela-mat matte white | <input type="checkbox"/> IN indikator indicator | 02 |
| SM12 | STIKALO ENOPOLNO SWITCH 1WAY | 20A 250V~ | 1M | <input checked="" type="checkbox"/> SB črna-mat soft touch black | | 03 |
| ⋮ | ⋮ | ⋮ | ⋮ | <input type="checkbox"/> AT antracit anthracite | | |
| ⋮ | ⋮ | ⋮ | ⋮ | <input type="checkbox"/> ES srebrna-mat elox silver | | |
| ⋮ | ⋮ | ⋮ | ⋮ | <input type="checkbox"/> IW bež-sijaj ivory white | | |

STIKALO ENOPOLNO 16AX 250V~ 1M



SM10

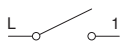

- stikalo brez tipke
 - 16AX 250V~, tip SM10
 - ustreza EN 60669-1
 - vijajčna pritrditev vodnikov 1.5-2.5mm²
- SWITCH 1WAY 16AX 250V~ 1M**
- switch without button
 - 16AX 250V~, type SM10
 - in accordance with EN 60669-1
 - screw contacts 1.5-2.5mm²

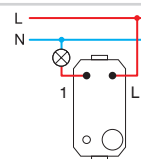

TIPKALO ENOPOLNO 16A 250V~ 1M



SM11



- tipkalo brez tipke
 - 16A 250V~, tip SM11
 - ustreza EN 60669-1
 - vijajčna pritrditev vodnikov 1.5-2.5mm²
- PUSH BUTTON 1WAY 16A 250V~ 1M**
- push button without button
 - 16A 250V~, type SM11
 - in accordance with EN 60669-1
 - screw contacts 1.5-2.5mm²

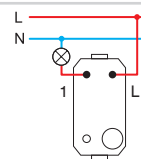

STIKALO ENOPOLNO 20A 250V~ 1M



SM12

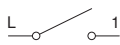

- stikalo brez tipke
 - 20A 250V~, tip SM12
 - ustreza EN 60669-1
 - vijajčna pritrditev vodnikov 1.5-2.5mm²
- SWITCH 1WAY 20A 250V~ 1M**
- switch without button
 - 20A 250V~, type SM12
 - in accordance with EN 60669-1
 - screw contacts 1.5-2.5mm²

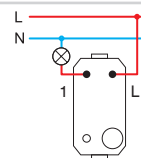

STIKALO DVOPOLNO 16AX 250V~ 1M



SM20

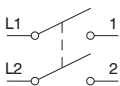

- stikalo brez tipke
 - 16AX 250V~, tip SM20
 - ustreza EN 60669-1
 - vijajčna pritrditev vodnikov 1.5-2.5mm²
 - samo v kombinaciji s tipko TM15
- SWITCH 2POLE 16AX 250V~ 1M**
- switch without button
 - 16AX 250V~, type SM20
 - in accordance with EN 60669-1
 - screw contacts 1.5-2.5mm²
 - only in combination with button TM15

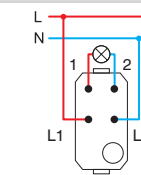

S W I T C H E S S M



SM40

STIKALO ŽALUZIJSKO 1-0-2 16AX 250V~ 1M

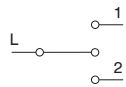

- stikalo brez tipke
- 16AX 250V~, tip SM40
- ustreza EN 60669-1
- vijačna pritrditev vodnikov 1.5-2.5mm²

SWITCH SHUTTERS 1-0-2 16AX 250V~ 1M

- switch without button
- 16AX 250V~, type SM40
- in accordance with EN 60669-1
- screw contacts 1.5-2.5mm²

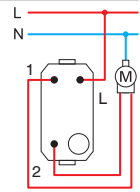

SM41

TIPKALO ŽALUZIJSKO 1-0-2 16A 250V~ 1M

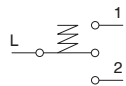

- tipkalo brez tipke
- 16A 250V~, tip SM41
- ustreza EN 60669-1
- vijačna pritrditev vodnikov 1.5-2.5mm²

PUSH BUTTON SHUTTERS 1-0-2 16A 250V~ 1M

- push button without button
- 16A 250V~, type SM41
- in accordance with EN 60669-1
- screw contacts 1.5-2.5mm²

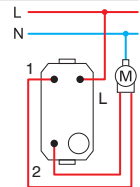

SM60

STIKALO MENJALNO 16AX 250V~ 1M

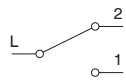

- stikalo brez tipke
- 16AX 250V~, tip SM60
- ustreza EN 60669-1
- vijačna pritrditev vodnikov 1.5-2.5mm²

SWITCH 2WAY 16AX 250V~ 1M

- switch without button
- 16AX 250V~, type SM60
- in accordance with EN 60669-1
- screw contacts 1.5-2.5mm²

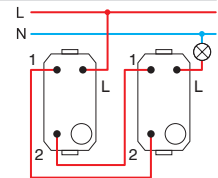

SM61

TIPKALO MENJALNO 16A 250V~ 1M

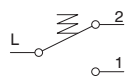

- tipkalo brez tipke
- 16A 250V~, tip SM61
- ustreza EN 60669-1
- vijačna pritrditev vodnikov 1.5-2.5mm²

PUSH BUTTON 2WAY 16A 250V~ 1M

- push button without button
- 16A 250V~, type SM61
- in accordance with EN 60669-1
- screw contacts 1.5-2.5mm²

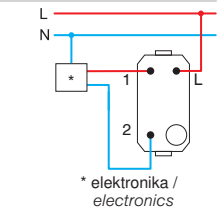

SM70

STIKALO KRIŽNO 16AX 250V~ 1M



- stikalo brez tipke
- 16AX 250V~, tip SM70
- ustreza EN 60669-1
- vijačna pritrditev vodnikov 1.5-2.5mm²

SWITCH INTERMEDIATE 16AX 250V~ 1M

- switch without button
- 16AX 250V~, type SM70
- in accordance with EN 60669-1
- screw contacts 1.5-2.5mm²

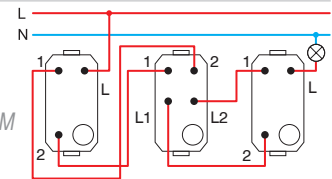

1M = 22,5 x 45
2M = 45 x 45

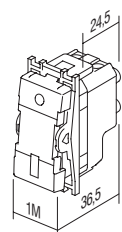
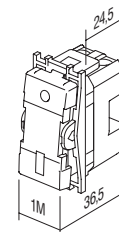



□ PW bela-sijaj
polar white
□ MW bela-mat
matte white



■ SB črna-mat
soft touch black



■ AT antracit
anthracite



□ ES srebrna-mat
elox silver



□ IW bež-sijaj
ivory white

STIKALO ENOPOLNO 16AX 250V~ 1M



- SM10PW - 16AX 250V~, tip SM10
 - SM10MW - ustreza EN 60669-1
 - SM10SB - vijačna pritrditev vodnikov 1.5-2.5 mm²
 - SM10AT - zamenljiva tipka
 - SM10ES
 - SM10IW
- SWITCH 1WAY 16AX 250V~ 1M**
- 16AX 250V~, type SM10
- in accordance with EN 60669-1
- screw contacts 1.5-2.5 mm²
- replaceable button



STIKALO ENOPOLNO 16AX 250V~ 1M __ IN



- SM10PWIN - IN indikator
 - SM10MWIN - 16AX 250V~, tip SM10
 - SM10SBIN - ustreza EN 60669-1
 - SM10ATIN - vijačna pritrditev vodnikov 1.5-2.5 mm²
 - SM10ESIN - tlvka ni priložena
 - SM10IWIN - zamenljiva tipka
- SWITCH 1WAY 16AX 250V~ 1M __ IN**
- IN indicator
- 16AX 250V~, type SM10
- in accordance with EN 60669-1
- screw contacts 1.5-2.5 mm²
- lamp is not included
- replaceable button



TIPKALO ENOPOLNO 16A 250V~ 1M

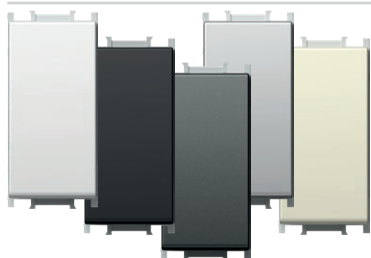

- SM11PW - 16A 250V~, tip SM11
 - SM11MW - ustreza EN 60669-1
 - SM11SB - vijačna pritrditev vodnikov 1.5-2.5 mm²
 - SM11AT - zamenljiva tipka
 - SM11ES
 - SM11IW
- PUSH BUTTON 1WAY 16A 250V~ 1M**
- 16A 250V~, type SM11
- in accordance with EN 60669-1
- screw contacts 1.5-2.5 mm²
- replaceable button



TIPKALO ENOPOLNO 16A 250V~ 1M __ IN 01



- SM11PWIN01 - IN 01 indikator zvonec
 - SM11MWIN01 - 16A 250V~, tip SM11
 - SM11SBIN01 - ustreza EN 60669-1
 - SM11ATIN01 - vijačna pritrditev vodnikov 1.5-2.5 mm²
 - SM11ESIN01 - tlvka ni priložena
 - SM11IWIN01 - zamenljiva tipka
- PUSH BUTTON 1WAY 16A 250V~ 1M __ IN 01**
- IN 01 indicator bell
- 16A 250V~, type SM11
- in accordance with EN 60669-1
- screw contacts 1.5-2.5 mm²
- lamp is not included
- replaceable button



S W I T C H E S S M

TIPKALO ENOPOLNO 16A 250V~ 1M __ IN 02



- SM11PWIN02 - IN 02 indikator luč
- SM11MWIN02 - 16A 250V~, tip SM11
- SM11SBIN02 - ustreza EN 60669-1
- SM11ATIN02 - vijakna pritržitev vodnikov 1.5-2.5 mm²
- SM11ESIN02 - tlička ni priložena
- SM11WIN02 - zamenljiva tipka

PUSH BUTTON 1WAY 16A 250V~ 1M __ IN 02

- IN 02 indicator light
- 16A 250V~, type SM11
- in accordance with EN 60669-1
- screw contacts 1.5-2.5 mm²
- lamp is not included
- replaceable button



STIKALO DVOPOLNO 16AX 250V~ 1M __ NT 03



- SM20PWNT03 - NT 03 nevtral 0-1
- SM20MWNT03 - 16AX 250V~, tip SM20
- SM20SBNT03 - ustreza EN 60669-1
- SM20ATNT03 - vijakna pritržitev vodnikov 1.5-2.5 mm²
- SM20ESNT03 - zamenljiva tipka
- SM20IWNT03

SWITCH 2POLE 16AX 250V~ 1M __ NT 03

- NT 03 neutral 0-1
- 16AX 250V~, type SM20
- in accordance with EN 60669-1
- screw contacts 1.5-2.5 mm²
- replaceable button



STIKALO DVOPOLNO 16AX 250V~ 1M __ IN



- SM20PWIN - IN indikator
- SM20MWIN - 16AX 250V~, tip SM20
- SM20SBIN - ustreza EN 60669-1
- SM20ATIN - vijakna pritržitev vodnikov 1.5-2.5 mm²
- SM20ESIN - tlička ni priložena
- SM20IWIN - zamenljiva tipka

SWITCH 2POLE 16AX 250V~ 1M __ IN

- IN indicator
- 16AX 250V~, type SM20
- in accordance with EN 60669-1
- screw contacts 1.5-2.5 mm²
- lamp is not included
- replaceable button



STIKALO ŽALUZIJSKO 1-0-2 16AX 250V~ 1M __ NT 10

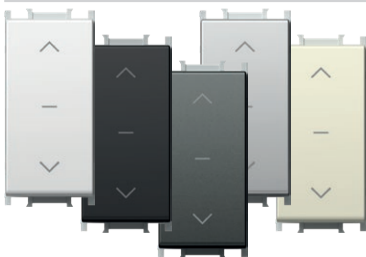

- SM40PWNT10 - NT 10 nevtral 1-0-2
- SM40MWNT10 - 16AX 250V~, tip SM40
- SM40SBNT10 - ustreza EN 60669-1
- SM40ATNT10 - vijakna pritržitev vodnikov 1.5-2.5 mm²
- SM40ESNT10 - zamenljiva tipka
- SM40IWNT10

SWITCH SHUTTERS 1-0-2 16AX 250V~ 1M __ NT 10

- NT 10 neutral 1-0-2
- 16AX 250V~, type SM40
- in accordance with EN 60669-1
- screw contacts 1.5-2.5 mm²
- replaceable button



TIPKALO ŽALUZIJSKO 1-0-2 16A 250V~ 1M __ NT 10



- SM41PWNT10 - NT 10 nevtral 1-0-2
- SM41MWNT10 - 16A 250V~, tip SM41
- SM41SBNT10 - ustreza EN 60669-1
- SM41ATNT10 - vijakna pritržitev vodnikov 1.5-2.5 mm²
- SM41ESNT10 - zamenljiva tipka
- SM41IWNT10

PUSH BUTTON SHUTTERS 1-0-2 16A 250V~ 1M __ NT 10

- NT 10 neutral 1-0-2
- 16A 250V~, type SM41
- in accordance with EN 60669-1
- screw contacts 1.5-2.5 mm²
- replaceable button



STIKALO MENJALNO 16AX 250V~ 1M



- SM60PW - 16AX 250V~, tip SM60
- SM60MW - ustreza EN 60669-1
- SM60SB - vijakna pritržitev vodnikov 1.5-2.5 mm²
- SM60AT - zamenljiva tipka
- SM60ES
- SM60IW

SWITCH 2WAY 16AX 250V~ 1M

- 16AX 250V~, type SM60
- in accordance with EN 60669-1
- screw contacts 1.5-2.5 mm²
- replaceable button



TIPKALO MENJALNO 16A 250V~ 1M

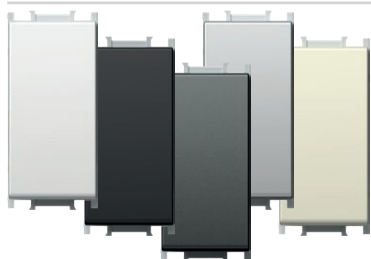

- SM61PW
- SM61MW
- SM61SB
- SM61AT
- SM61ES
- SM61IW

- 16A 250V~, tip SM61
 - ustreza EN 60669-1
 - vijačna pritrditev vodnikov 1.5-2.5 mm²
 - zamenljiva tipka

PUSH BUTTON 2WAY 16A 250V~ 1M

- 16A 250V~, type SM61
 - in accordance with EN 60669-1
 - screw contacts 1.5-2.5 mm²
 - replaceable button



TIPKALO MENJALNO Z VRVICO 16A 250V~ 1M __ CD



- SM62PWCD
- SM62MWCD
- SM62SBCD
- SM62ATCD
- SM62ESCD
- SM62IWCD

- CD indikator+vrvica
 - vrvica dolžine 1.5m
 - 16A 250V~, tip SM62
 - ustreza EN 60669-1
 - vijačna pritrditev vodnikov 1.5-2.5 mm²

PUSH BUTTON 2WAY WITH CORD 16A 250V~ 1M __ CD

- CD indikator+cord
 - cord length 1.5m
 - 16A 250V~, type SM62
 - in accordance with EN 60669-1
 - screw contacts 1.5-2.5 mm²



STIKALO KRIŽNO 16AX 250V~ 1M



- SM70PW
- SM70MW
- SM70SB
- SM70AT
- SM70ES
- SM70IW

- 16AX 250V~, tip SM70
 - ustreza EN 60669-1
 - vijačna pritrditev vodnikov 1.5-2.5 mm²
 - zamenljiva tipka

SWITCH INTERMEDIATE 16AX 250V~ 1M

- 16AX 250V~, type SM70
 - in accordance with EN 60669-1
 - screw contacts 1.5-2.5 mm²
 - replaceable button



1M = 22,5 x 45
 2M = 45 x 45

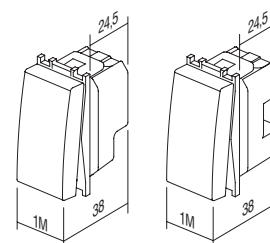

B U T T O N S T M

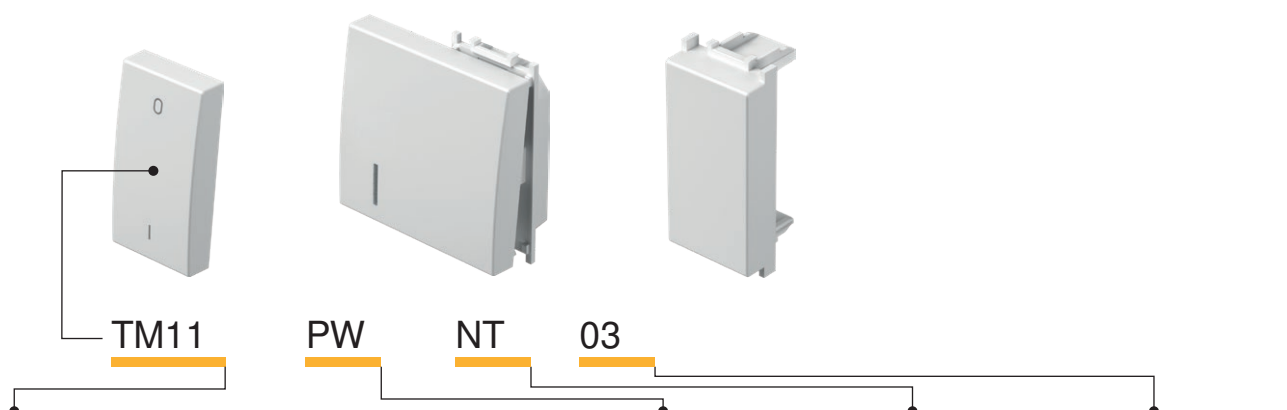

| tip type | naziv description | velikost size | barva colour | opcijski opis 1 optional data 1 | opcijski opis 2 optional data 2 |
|-------------|----------------------|------------------|---|------------------------------------|------------------------------------|
| TM11 | TIPKA BUTTON | 1M | <input type="checkbox"/> PW bela-sijaj polar white | NT nevtral neutral | 01 |
| TM12 | TIPKA BUTTON | 2M | <input type="checkbox"/> MW bela-mat matte white | IN indikator indicator | 02 |
| TM21 | POLNILO BLANK | 1M | <input checked="" type="checkbox"/> SB črna-mat soft touch black | | 03 |
| : | : | : | <input type="checkbox"/> AT antracit anthracite | | |
| : | : | : | <input type="checkbox"/> ES srebrna-mat elox silver | | |
| : | : | : | <input type="checkbox"/> IW bež-sijaj ivory white | | |

TIPKA 1M



- TM11PW
- TM11MW
- TM11SB
- TM11AT
- TM11ES
- TM11IW

- zamenljiva tipka velikosti 1M
- ustreza EN 60669-1

BUTTON 1M

- replaceable button 1M
- in accordance with EN 60669-1



TIPKA 1M INDIKATOR



- TM11PWIN
- TM11MWIN
- TM11SBIN
- TM11ATIN
- TM11ESIN
- TM11IWIN

- zamenljiva tipka velikosti 1M
- ustreza EN 60669-1

BUTTON 1M INDICATOR

- replaceable button 1M
- in accordance with EN 60669-1



TIPKA 2M

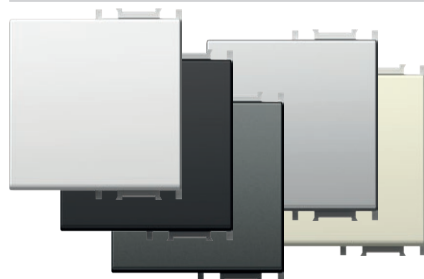

- TM12PW
- TM12MW
- TM12SB
- TM12AT
- TM12ES
- TM12IW

- zamenljiva tipka velikost 2M z nosilcem tipke
- uporablja se pri nadgradnji stikala ali tipkala
velikosti 1M v velikost 2M
- ustreza EN 60669-1

BUTTON 2M

- replaceable button 2M with button carrier
- to upgrade switch or push button
from size 1M to size 2M
- in accordance with EN 60669-1



TIPKA 2M INDIKATOR

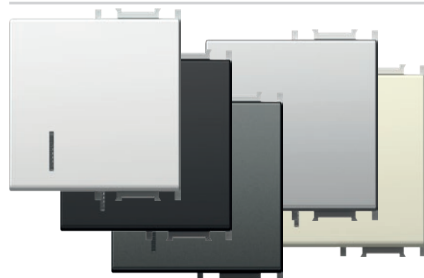

- TM12PWIN
- TM12MWIN
- TM12SBIN
- TM12ATIN
- TM12ESIN
- TM12IWIN

- zamenljiva tipka velikost 2M z nosilcem tipke
- uporablja se pri nadgradnji stikala ali tipkala
velikosti 1M v velikost 2M
- ustreza EN 60669-1

BUTTON 2M INDICATOR

- replaceable button 2M with button carrier
- to upgrade switch or push button
from size 1M to size 2M
- in accordance with EN 60669-1



TIPKA 2M Z NAPISNO PLOŠČICO

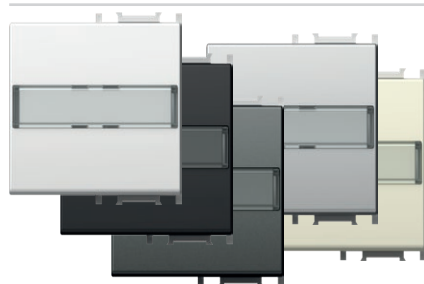

- TM13PWIL
- TM13MWIL
- TM13SBIL
- TM13ATIL
- TM13ESIL
- TM13IWIL

- zamenljiva tipka velikost 2M z nosilcem tipke
 - uporablja se pri nadgradnji stikala ali tipkala velikosti 1M v velikost 2M
 - ustreza EN 60669-1

BUTTON 2M WITH INSCRIPTION PLATE
 - replaceable button 2M with button carrier
 - to upgrade switch or push button from size 1M to size 2M
 - in accordance with EN 60669-1



TIPKA 1M DVOPOLNA

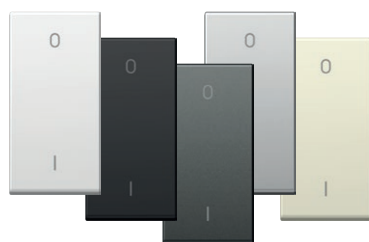

- TM15PW
- TM15MW
- TM15SB
- TM15AT
- TM15ES
- TM15IW

- zamenljiva tipka velikosti 1M
 - samo v kombinaciji z mehanizmom SM20
 - ustreza EN 60669-1

BUTTON 1M 2POLE
 - replaceable button 1M
 - only in combination with mechanism SM20
 - in accordance with EN 60669-1



POLNILO 1M

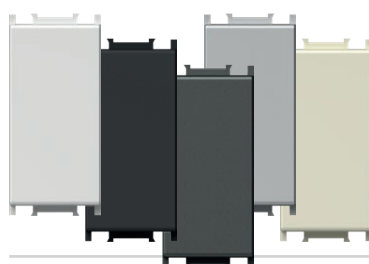

- TM21PW
- TM21MW
- TM21SB
- TM21AT
- TM21ES
- TM21IW

- za zapolnjevanje praznih mest
 - ustreza EN 60669-1

BLANK 1M
 - blank modul to fill up empty spaces
 - in accordance with EN 60669-1



POLNILO 2M

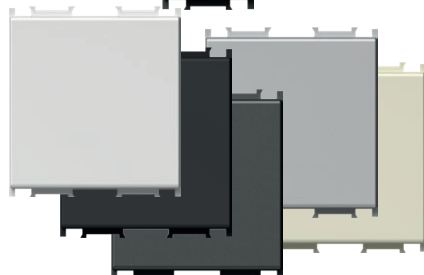

- TM22PW
- TM22MW
- TM22SB
- TM22AT
- TM22ES
- TM22IW

- za zapolnjevanje praznih mest
 - ustreza EN 60669-1

BLANK 2M
 - blank modul to fill up empty spaces
 - in accordance with EN 60669-1

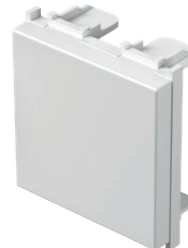

UVODNICA 1M

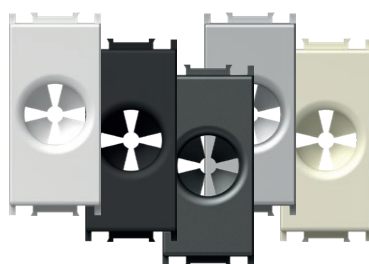

- TM31PW
- TM31MW
- TM31SB
- TM31AT
- TM31ES
- TM31IW

- uvodnica za kabel
 - ustreza EN-60669-1

CABLE OUTLET 1M
 - outlet for cable
 - in accordance with EN-60669-1



1M = 22,5 x 45
 2M = 45 x 45

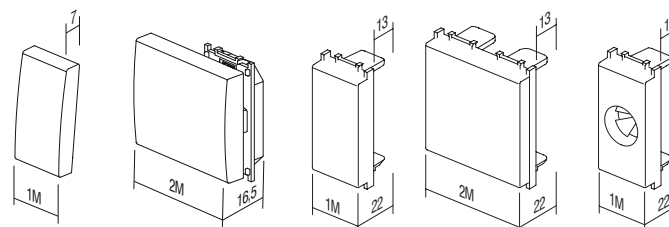

TM11
 TM15

TM12
 TM13

TM21

TM22

TM31

B U T T O N S T M

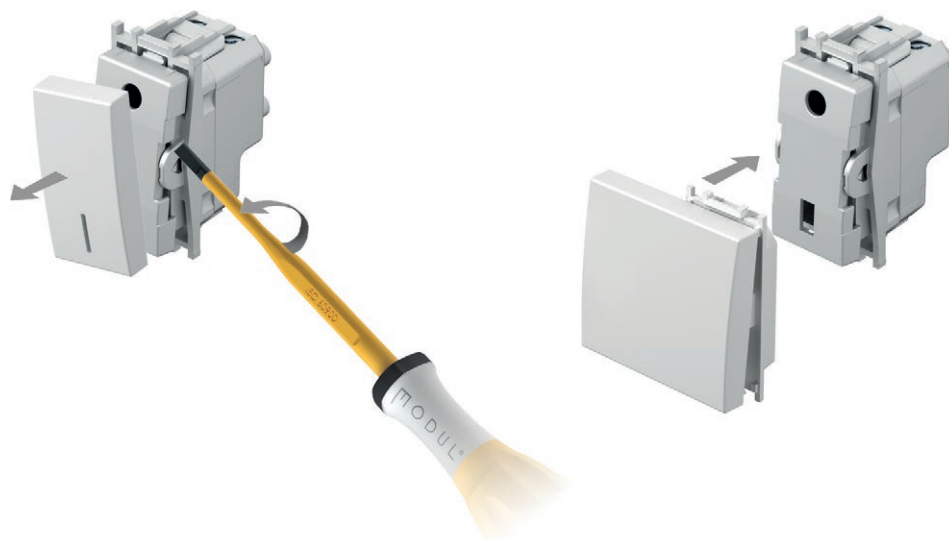

LASERSKI TISK NA TIPKE

- laserski tisk poljubne grafike na označena mesta
- standardni simboli iz zaloge, ostali po naročilu

LASER PRINT ON BUTTONS

- laser print of any graphics on marked locations
- standard symbols from stock, other on request

1M

| |
|---|
| A |
| B |
| C |

2M

| | | |
|---|---|---|
| A | D | G |
| B | E | H |
| C | F | I |

GRAFIKE

SYMBOLS

| | | | | | | | | | | | | | | | |
|----|----|----|----|----|-------|-------|-----|----|----|----|----|----|-------------|----|----|
| 01 | 02 | 03 | 04 | 05 | 06 | 07 | 08 | 09 | 10 | 11 | 12 | 13 | 14 | 20 | 21 |
| | | | | | | | | | | | | | 1 0 2 | + | - |
| 22 | 23 | 24 | 25 | 26 | 27 | 28 | 29 | 30 | 31 | 32 | 33 | 34 | 35 | 36 | 37 |
| | | | | | alarm | alarm | OFF | ON | + | | | | AC | | |
| 38 | 39 | 40 | 41 | 42 | 43 | 44 | 45 | 46 | 47 | 48 | | | | | |
| | | | | | | | | | | | | | | | |

STANDARDNE GRAFIKE

STANDARD SYMBOLS

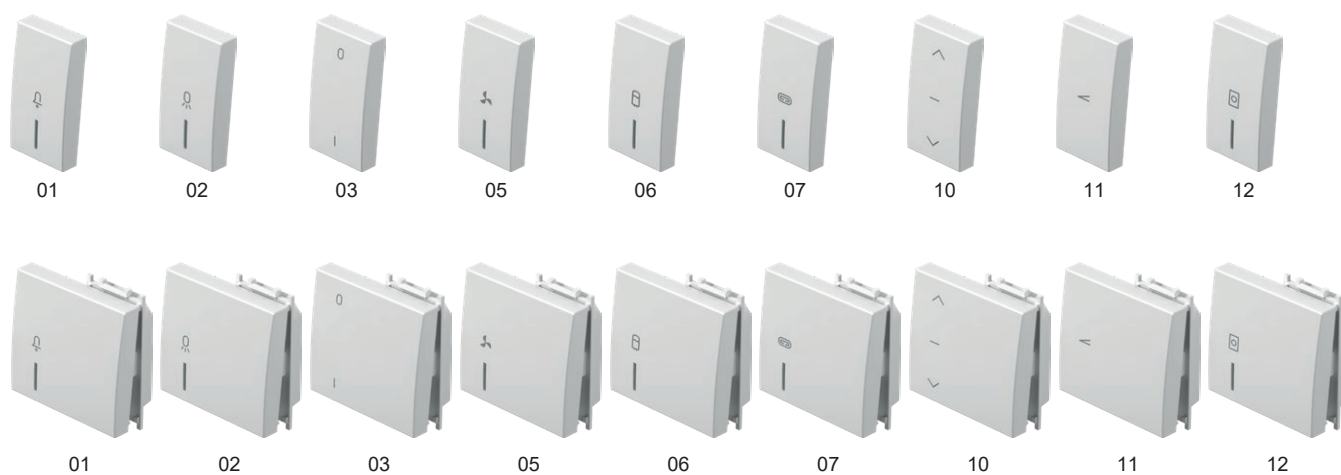

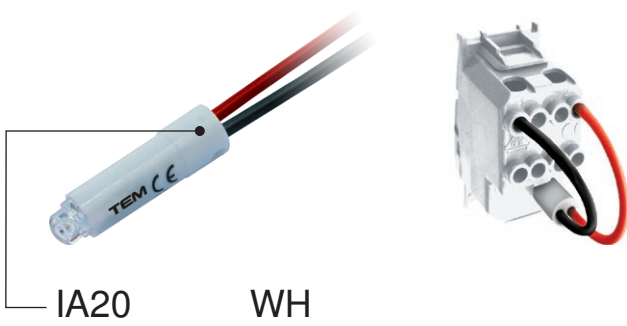

| tip type | naziv description | tehnični opis technical data | barva colour |
|-------------|--|---------------------------------|--|
| IA10 | TLIVKA NEON LAMP | 230V~ 0,34W | <input type="checkbox"/> WH bela white |
| IA20 | LED SIGNALIZACIJA LED SIGNALLING UNIT | 230V~ AC/DC 0,40W | <input checked="" type="checkbox"/> BL modra blue |
| IA21 | LED SIGNALIZACIJA LED SIGNALLING UNIT | 24V AC/DC 0,20W | <input checked="" type="checkbox"/> RD rdeča red |
| · | · | · | <input checked="" type="checkbox"/> GR zelena green |
| · | · | · | <input checked="" type="checkbox"/> OR oranžna orange |

TLIVKA 230V~ 0,34W



IA10OR

- za indikacijo, signalizacijo ali stalno signalizacijo
- v kombinaciji s tipko z indikatorjem

NEON LAMP 230V~ 0,34W

- for indication, signalling or permanent signalling
- in combination with a button featuring an indicator

LED SIGNALIZACIJA 230V AC/DC 0,40W

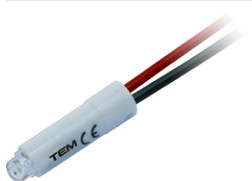

IA20WH
 IA20GR
 IA20RD
 IA20BL

- za indikacijo, signalizacijo ali stalno signalizacijo
- v kombinaciji s tipko z indikatorjem

LED SIGNALLING UNIT 230V AC/DC 0,40W

- for indication, signalling or permanent signalling
- in combination with a button featuring an indicator

LED SIGNALIZACIJA 24V AC/DC 0,20W

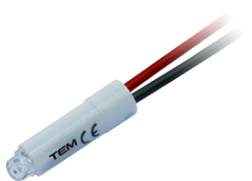

IA21WH
 IA21RD

- za indikacijo, signalizacijo ali stalno signalizacijo
- v kombinaciji s tipko z indikatorjem

LED SIGNALLING UNIT LAMP 24V AC/DC 0,20W

- for indication, signalling or permanent signalling
- in combination with a button featuring an indicator

LED SIGNALIZACIJA 12V AC/DC 0,10W

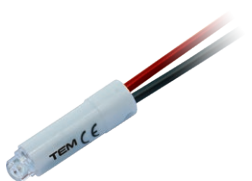

IA22WH
 IA22RD

- za indikacijo, signalizacijo ali stalno signalizacijo
- v kombinaciji s tipko z indikatorjem

LED SIGNALLING UNIT 12V AC/DC 0,10W

- for indication, signalling or permanent signalling
- in combination with a button featuring an indicator

RC VEZJE 250V~

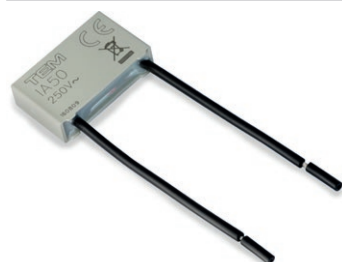

IA50

- RC vezje za odpravo motenj pri delovanju LED sijalk
- možna je vzporedna vezava več RC vezij s sijalkami
- 0,1 µF, 100 Ω, 250V~

RC CIRCUIT 250V~

- RC circuit to eliminate disturbances in the operation of LED lamps
- parallel connections of more RC circuits with lamps are possible
- 0,1 µF, 100 Ω, 250V~

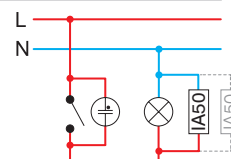

S I G N A L I Z A T I O N I A

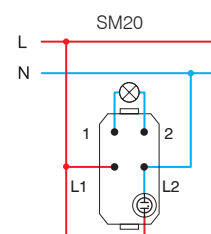
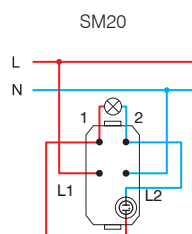
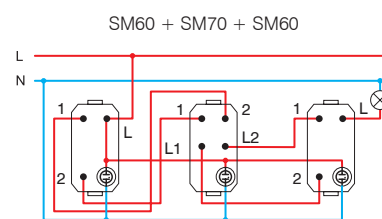
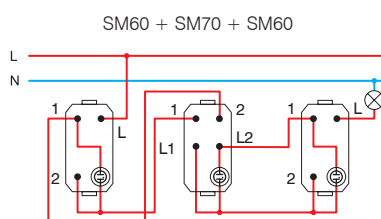
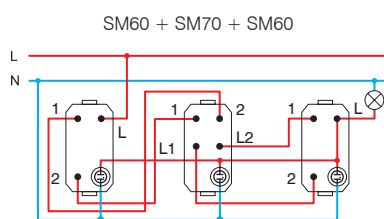
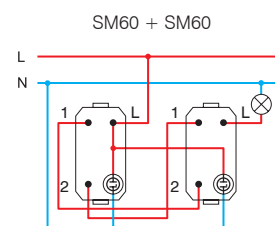
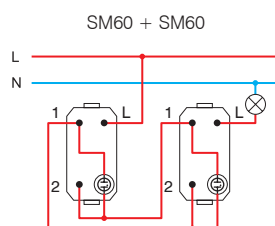
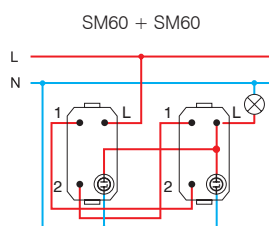
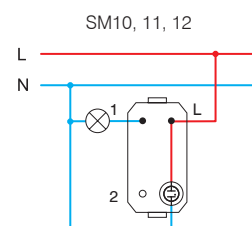
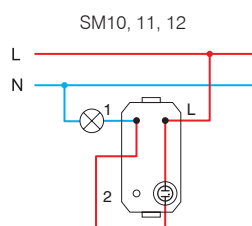
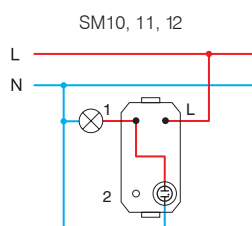
Indikacija /
Indication* Signalizacija /
SignalizationStalna signalizacija
Permanent signalling

* vezave niso primerne za varčne (CFL, LED) sijalke /
the connections are not suitable for energy-saving bulbs (CFL, LED)

1M = 22,5 x 45
2M = 45 x 45

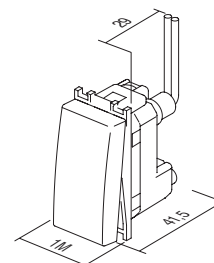

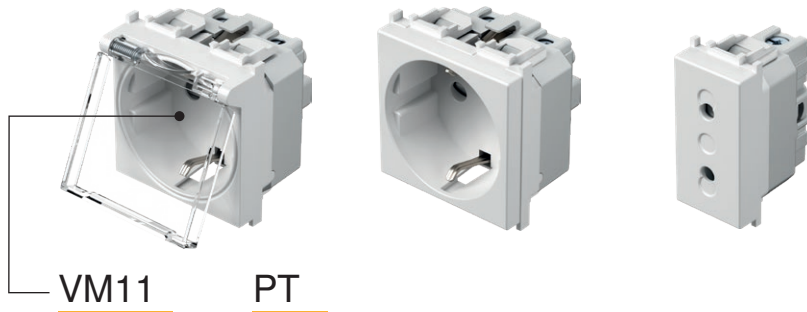

| tip type | naziv description | tehnični opis technical data | velikost size | barva colour | | | | | | | | | | | | | | | | | | | | | |
|---|--|---|------------------|--|---|---|--|---|--|---|---|---|---|---|--|---|---|--|---|--|---|---|--|---|---|
| VM10 | VTIČNICA SCHUKO+KS SOCKET SCHUKO+KS | 2P+E 16A 250V~ | 2M | <table border="0"> <tr> <td><input type="checkbox"/> PW bela-sijaj polar white</td> <td><input checked="" type="checkbox"/> PT bela+prozorna white+transparent</td> <td><input type="checkbox"/> PP bela+bela white+white</td> </tr> </table> | <input type="checkbox"/> PW bela-sijaj polar white | <input checked="" type="checkbox"/> PT bela+prozorna white+transparent | <input type="checkbox"/> PP bela+bela white+white | | | | | | | | | | | | | | | | | | |
| <input type="checkbox"/> PW bela-sijaj polar white | <input checked="" type="checkbox"/> PT bela+prozorna white+transparent | <input type="checkbox"/> PP bela+bela white+white | | | | | | | | | | | | | | | | | | | | | | | |
| VM11 | VTIČNICA SCHUKO+KS+POKROV SOCKET SCHUKO+KS+COVER | 2P+E 16A 250V~ | 2M | <table border="0"> <tr> <td><input type="checkbox"/> MW bela- mat matte white</td> <td><input checked="" type="checkbox"/> MT bela+prozorna white+transparent</td> <td><input type="checkbox"/> MM bela+bela white+white</td> </tr> </table> | <input type="checkbox"/> MW bela- mat matte white | <input checked="" type="checkbox"/> MT bela+prozorna white+transparent | <input type="checkbox"/> MM bela+bela white+white | | | | | | | | | | | | | | | | | | |
| <input type="checkbox"/> MW bela- mat matte white | <input checked="" type="checkbox"/> MT bela+prozorna white+transparent | <input type="checkbox"/> MM bela+bela white+white | | | | | | | | | | | | | | | | | | | | | | | |
| VM20 | VTIČNICA EURO+KS SOCKET EURO+KS | 2P 10A 250V~ | 1M | <table border="0"> <tr> <td><input checked="" type="checkbox"/> SB črna-mat soft touch black</td> <td><input checked="" type="checkbox"/> BT črna+prozorna black+transparent</td> <td><input checked="" type="checkbox"/> BB črna+črna soft touch black+black</td> </tr> <tr> <td><input checked="" type="checkbox"/> AT antracit anthracite</td> <td><input checked="" type="checkbox"/> AT antracit+prozorna anthracite+transparent</td> <td><input checked="" type="checkbox"/> AA antracit+antracit anthracite+anthracite</td> </tr> <tr> <td><input checked="" type="checkbox"/> ES srebrna-mat elox silver</td> <td><input checked="" type="checkbox"/> ST srebrna+prozorna silver+transparent</td> <td><input checked="" type="checkbox"/> SS srebrna+srebrna silver+silver</td> </tr> <tr> <td><input checked="" type="checkbox"/> IW bež-sijaj ivory white</td> <td><input checked="" type="checkbox"/> IT bež+prozorna ivory+transparent</td> <td><input checked="" type="checkbox"/> II bež+bež ivory+ivory</td> </tr> <tr> <td><input checked="" type="checkbox"/> RD rdeča red</td> <td><input checked="" type="checkbox"/> RT rdeča+prozorna red+transparent</td> <td><input checked="" type="checkbox"/> RR rdeča+rdeča red+red</td> </tr> <tr> <td><input checked="" type="checkbox"/> GR zelena green</td> <td><input checked="" type="checkbox"/> GT zelena+prozorna green+transparent</td> <td><input checked="" type="checkbox"/> GG zelena+zelena green+green</td> </tr> <tr> <td><input checked="" type="checkbox"/> OR oranžna orange</td> <td><input checked="" type="checkbox"/> OT oranžna+prozorna orange+transparent</td> <td><input checked="" type="checkbox"/> OO oranžna+oranžna orange+orange</td> </tr> </table> | <input checked="" type="checkbox"/> SB črna-mat soft touch black | <input checked="" type="checkbox"/> BT črna+prozorna black+transparent | <input checked="" type="checkbox"/> BB črna+črna soft touch black+black | <input checked="" type="checkbox"/> AT antracit anthracite | <input checked="" type="checkbox"/> AT antracit+prozorna anthracite+transparent | <input checked="" type="checkbox"/> AA antracit+antracit anthracite+anthracite | <input checked="" type="checkbox"/> ES srebrna-mat elox silver | <input checked="" type="checkbox"/> ST srebrna+prozorna silver+transparent | <input checked="" type="checkbox"/> SS srebrna+srebrna silver+silver | <input checked="" type="checkbox"/> IW bež-sijaj ivory white | <input checked="" type="checkbox"/> IT bež+prozorna ivory+transparent | <input checked="" type="checkbox"/> II bež+bež ivory+ivory | <input checked="" type="checkbox"/> RD rdeča red | <input checked="" type="checkbox"/> RT rdeča+prozorna red+transparent | <input checked="" type="checkbox"/> RR rdeča+rdeča red+red | <input checked="" type="checkbox"/> GR zelena green | <input checked="" type="checkbox"/> GT zelena+prozorna green+transparent | <input checked="" type="checkbox"/> GG zelena+zelena green+green | <input checked="" type="checkbox"/> OR oranžna orange | <input checked="" type="checkbox"/> OT oranžna+prozorna orange+transparent | <input checked="" type="checkbox"/> OO oranžna+oranžna orange+orange |
| <input checked="" type="checkbox"/> SB črna-mat soft touch black | <input checked="" type="checkbox"/> BT črna+prozorna black+transparent | <input checked="" type="checkbox"/> BB črna+črna soft touch black+black | | | | | | | | | | | | | | | | | | | | | | | |
| <input checked="" type="checkbox"/> AT antracit anthracite | <input checked="" type="checkbox"/> AT antracit+prozorna anthracite+transparent | <input checked="" type="checkbox"/> AA antracit+antracit anthracite+anthracite | | | | | | | | | | | | | | | | | | | | | | | |
| <input checked="" type="checkbox"/> ES srebrna-mat elox silver | <input checked="" type="checkbox"/> ST srebrna+prozorna silver+transparent | <input checked="" type="checkbox"/> SS srebrna+srebrna silver+silver | | | | | | | | | | | | | | | | | | | | | | | |
| <input checked="" type="checkbox"/> IW bež-sijaj ivory white | <input checked="" type="checkbox"/> IT bež+prozorna ivory+transparent | <input checked="" type="checkbox"/> II bež+bež ivory+ivory | | | | | | | | | | | | | | | | | | | | | | | |
| <input checked="" type="checkbox"/> RD rdeča red | <input checked="" type="checkbox"/> RT rdeča+prozorna red+transparent | <input checked="" type="checkbox"/> RR rdeča+rdeča red+red | | | | | | | | | | | | | | | | | | | | | | | |
| <input checked="" type="checkbox"/> GR zelena green | <input checked="" type="checkbox"/> GT zelena+prozorna green+transparent | <input checked="" type="checkbox"/> GG zelena+zelena green+green | | | | | | | | | | | | | | | | | | | | | | | |
| <input checked="" type="checkbox"/> OR oranžna orange | <input checked="" type="checkbox"/> OT oranžna+prozorna orange+transparent | <input checked="" type="checkbox"/> OO oranžna+oranžna orange+orange | | | | | | | | | | | | | | | | | | | | | | | |



VTIČNICA SCHUKO+KS 2P+E 16A 250V~ 2M

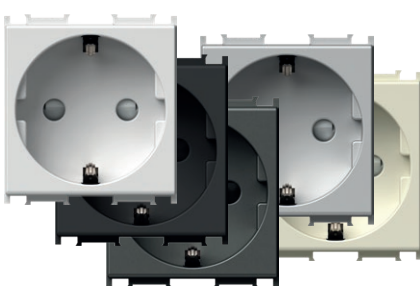

- VM10PW
- VM10MW
- VM10SB
- VM10AT
- VM10ES
- VM10IW

- 2P+E schuko
- 16A 250V~, tip VM10
- ustreza IEC 60884-1, CEE7
- vijajčna pritrditev vodnikov 1.5-2.5 mm²
- vgrajena zaščita pred dotikom kontaktov

SOCKET SCHUKO+KS 2P+E 16A 250V~ 2M

- 2P+E schuko
- 16A 250V~, type VM10
- in accordance with IEC 60884-1, CEE7
- screw contacts 1.5-2.5 mm²
- shuttered live contacts



VTIČNICA SCHUKO+KS 2P+E 16A 250V~ 2M

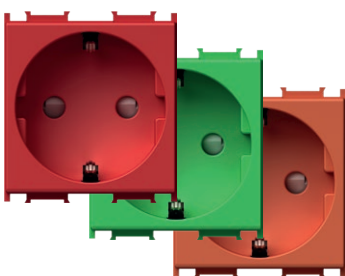

- VM10RD
- VM10GR
- VM10OR

- 2P+E schuko
- 16A 250V~, tip VM10
- ustreza IEC 60884-1, CEE7
- vijajčna pritrditev vodnikov 1.5-2.5 mm²
- vgrajena zaščita pred dotikom kontaktov

SOCKET SCHUKO+KS 2P+E 16A 250V~ 2M

- 2P+E schuko
- 16A 250V~, type VM10
- in accordance with IEC 60884-1, CEE7
- screw contacts 1.5-2.5 mm²
- shuttered live contacts



VTIČNICA SCHUKO+KS+POKROV 2P+E 16A 250V~ 2M

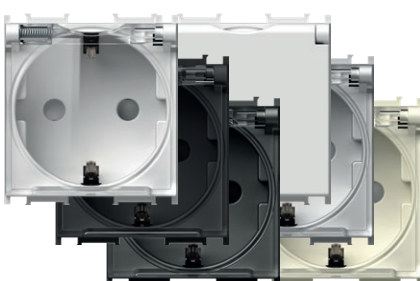

- VM11PT
- VM11MT
- VM11BT
- VM11AT
- VM11ST
- VM11IT
- VM11PP

- 2P+E schuko+pokrov
- 16A 250V~, tip VM11
- ustreza IEC 60884-1, CEE7
- vijajčna pritrditev vodnikov 1.5-2.5 mm²
- vgrajena zaščita pred dotikom kontaktov

SOCKET SCHUKO+KS+COVER
2P+E 16A 250V~ 2M

- 2P+E schuko+cover
- 16A 250V~, type VM11
- in accordance with IEC 60884-1, CEE7
- screw contacts 1.5-2.5 mm²
- shuttered live contacts



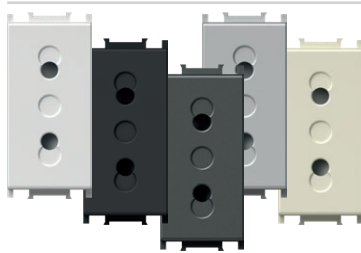

- VM20PW
- VM20MW
- VM20SB
- VM20AT
- VM20ES
- VM20IW

VTIČNICA EURO+KS 2P 10A 250V~ 1M

- 2P euro
- 10A 250V~, tip VM20
- ustreza IEC 60884-1, CEE7
- vijačna pritrditev vodnikov 1.5-2.5 mm²
- vgrajena zaščita pred dotikom kontaktov

SOCKET EURO+KS 2P 10A 250V~ 1M

- 2P Euro
- 10A 250V~, type VM20
- in accordance with IEC 60884-1, CEE7
- screw contacts 1.5-2.5 mm²
- shuttered live contacts

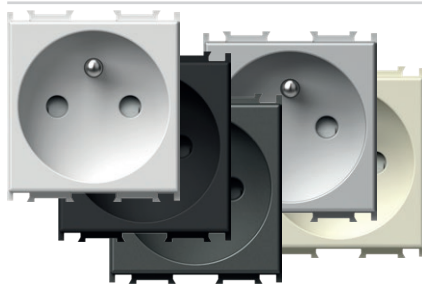

- VM40PW
- VM40MW
- VM40SB
- VM40AT
- VM40ES
- VM40IW

VTIČNICA FRANCOSKA+KS 2P+E 16A 250V~ 2M

- 2P+E francoska
- 16A 250V~, tip VM40
- ustreza IEC 60884-1, NF C 61-314, CEE7
- vijačna pritrditev vodnikov 1.5-2.5 mm²
- vgrajena zaščita pred dotikom kontaktov

SOCKET FRENCH+KS 2P+E 16A 250V~ 2M

- 2P+E French
- 16A 250V~, type VM40
- in accordance with IEC 60884-1, NF C 61-314, CEE7
- screw contacts 1.5-2.5 mm²
- shuttered live contacts

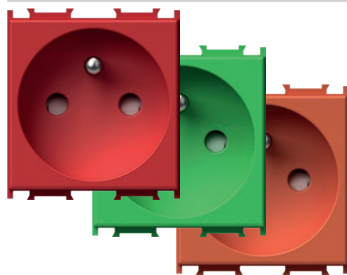

- VM40RD
- VM40GR
- VM40OR

VTIČNICA FRANCOSKA+KS 2P+E 16A 250V~ 2M

- 2P+E francoska
- 16A 250V~, tip VM40
- ustreza IEC 60884-1, NF C 61-314, CEE7
- vijačna pritrditev vodnikov 1.5-2.5 mm²
- vgrajena zaščita pred dotikom kontaktov

SOCKET FRENCH+KS 2P+E 16A 250V~ 2M

- 2P+E French
- 16A 250V~, type VM40
- in accordance with IEC 60884-1, NF C 61-314, CEE7
- screw contacts 1.5-2.5 mm²
- shuttered live contacts



- VM41PT
- VM41MT
- VM41BT
- VM41AT
- VM41PP
- VM41ST
- VM41IT

VTIČNICA FRANCOSKA+KS+POKROV 2P+E 16A 250V~ 2M

- 2P+E francoska+pokrov
- 16A 250V~, tip VM41
- ustreza IEC 60884-1, NF C 61-314, CEE7
- vijačna pritrditev vodnikov 1.5-2.5 mm²
- vgrajena zaščita pred dotikom kontaktov

SOCKET FRENCH+KS+COVER

- 2P+E 16A 250V~ 2M
- 2P+E French+cover
- 16A 250V~, type VM41
- in accordance with IEC 60884-1, NF C 61-314, CEE7
- screw contacts 1.5-2.5 mm²
- shuttered live contacts

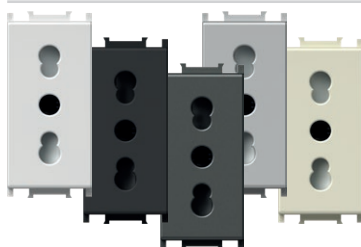

- VM30PW
- VM30MW
- VM30SB
- VM30AT
- VM30ES
- VM30IW

VTIČNICA ITALIJANSKA P17/11+KS 2P+E 16A 250V~ 1M

- 2P+E italijanska P17/11
- 16A 250V~, tip VM30
- ustreza IEC 60884-1, CEI 23-50
- vijačna pritrditev vodnikov 1.5-2.5 mm²
- vgrajena zaščita pred dotikom kontaktov

SOCKET ITALIAN P17/11+KS 2P+E 16A 250V~ 1M

- 2P+E Italian P17/11
- 16A 250V~, type VM30
- in accordance with IEC 60884-1, CEI 23-50
- screw contacts 1.5-2.5 mm²
- shuttered live contacts

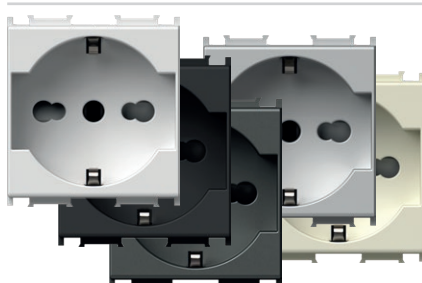

- VM31PW
- VM31MW
- VM31SB
- VM31AT
- VM31ES
- VM31IW

VTIČNICA SCHUKO/ITA P17/11+KS 2P+E 16A 250V~ 2M

- 2P+E schuko/italijanska P17/11
- 16A 250V~, tip VM31
- ustreza IEC 60884-1, CEI 23-50
- vijačna pritrditev vodnikov 1.5-2.5 mm²
- vgrajena zaščita pred dotikom kontaktov

SOCKET SCHUKO/ITA P17/11+KS

- 2P+E 16A 250V~ 2M
- 2P+E schuko/Italian P17/11
- 16A 250V~, type VM31
- in accordance with IEC 60884-1, CEI 23-50
- screw contacts 1.5-2.5 mm²
- shuttered live contacts

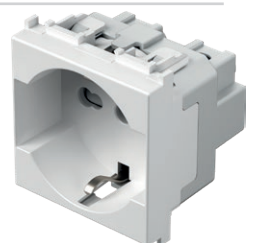

VTIČNICA SCHUKO/ITA P30+KS 2P+E 16A 250V~ 2M

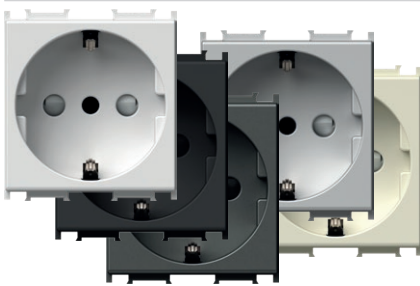

- VM32PW
- VM32MW
- VM32SB
- VM32AT
- VM32ES
- VM32IW

- 2P+E schuko/italijanska P30
- 16A 250V~, tip VM32
- ustreza IEC 60884-1, CEI 23-50
- vijačna pritrditvev vodnikov 1.5-2.5 mm²
- vgrajena zaščita pred dotikom kontaktov



SOCKET SCHUKO/ITA P30+KS
2P+E 16A 250V~ 2M

- 2P+E schuko/Italian P30
- 16A 250V~, type VM32
- in accordance with IEC 60884-1, CEI 23-50
- screw contacts 1.5-2.5 mm²
- shuttered live contacts

VTIČNICA ITALIJANSKA P11+KS 2P+E 10A 250V~ 1M

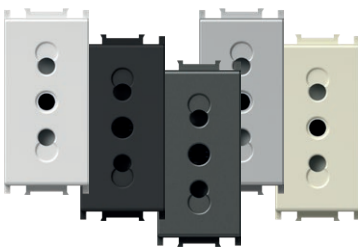

- VM33PW
- VM33MW
- VM33SB
- VM33AT
- VM33ES
- VM33IW

- 2P+E italijanska P11
- 10A 250V~, tip VM33
- ustreza IEC 60884-1, CEI 23-50
- vijačna pritrditvev vodnikov 1.5-2.5 mm²
- vgrajena zaščita pred dotikom kontaktov



SOCKET ITALIAN P11+KS 2P+E 10A 250V~ 1M

- 2P+E Italian P11
- 10A 250V~, type VM33
- in accordance with IEC 60884-1, CEI 23-50
- screw contacts 1.5-2.5 mm²
- shuttered live contacts

VTIČNICA EURO/AMERIŠKA+KS 2P 16A 250V~ 1M

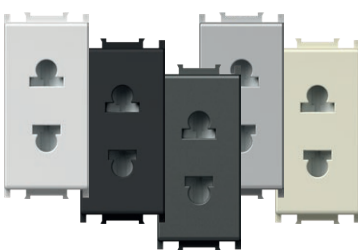

- VM21PW
- VM21MW
- VM21SB
- VM21AT
- VM21ES
- VM21IW

- 2P euro/ameriška
- 16A 250V~, tip VM21
- vijačna pritrditvev vodnikov 1.5-2.5 mm²
- vgrajena zaščita pred dotikom kontaktov
- samo za države izven EU



SOCKET EURO/AMERICAN+KS 2P 16A 250V~ 1M

- 2P Euro/American
- 16A 250V~, type VM21
- screw contacts 1.5-2.5 mm²
- shuttered live contacts
- only for countries not members of EU

VTIČNICA BRITANSKA BS 1363-2+KS 2P+E 13A 250V~ 2M

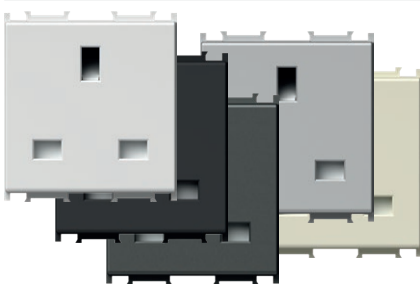

- VM52PW
- VM52MW
- VM52SB
- VM52AT
- VM52ES
- VM52IW

- 2P+E britanski standard BS 1363-2
- 13A/250V~, tip VM52
- ustreza BS 1363-2
- vijačna pritrditvev vodnikov 1.5-4 mm²
- vgrajena zaščita pred dotikom kontaktov

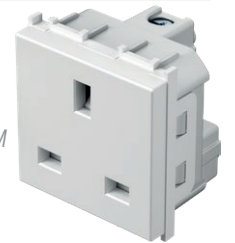

SOCKET BRITISH BS 1363-2+KS 2P+E 13A 250V~ 2M

- 2P+E British BS 1363-2
- 13A 250V~, type VM52
- in accordance with BS 1363-2
- screw contacts 1.5-4 mm²
- shuttered live contacts

VTIČNICA VEČSTANDARDNA+KS 2P+E 13A 250V~ 2M

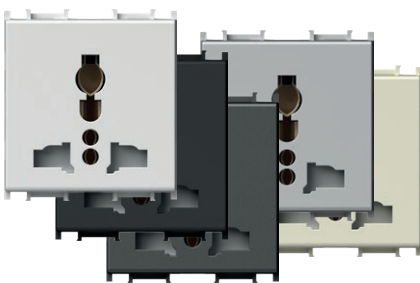

- VM55PW
- VM55MW
- VM55SB
- VM55AT
- VM55ES
- VM55IW

- brezvijačna pritrditvev vodnikov 1.5-2.5mm²
- vgrajena zaščita pred dotikom kontaktov

SOCKET MULTI-STANDARD+KS 2P+E 13A 250V~ 2M

- plug-in contacts 1.5-2.5 mm²
- shuttered live contacts



PRENAPETOSTNA ZAŠČITA MPE MINI 275V/50Hz



VM80

- vzporedna vezava s prvo vtičnico v seriji
- razred zaščite III
- U_c=275Vac, U_{oc}/I_{sc}=6kV/3kA, U_p<800V
- ustreza IEC 61643-1
- vodniki 1.5mm², IP20
- zvočni signal ob uničenju



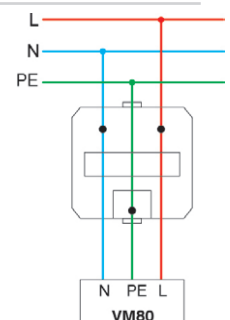

SURGE PROTECTOR MPE MINI 275V/50Hz

- parallel connection with the first socket in the row
- protection class III
- U_c=275Vac, U_{oc}/I_{sc}=6kV/3kA, U_p<800V
- in accordance with IEC 61643-1
- wires 1.5mm², IP20
- sound signal at breakdown





S O C K E T S V M

 UJEMANJE VTIČNIC IN VTIČEV
 SOCKETS AND PLUGS MATCHING

| VTIČNICA / SOCKET | VM10 VM11 | VM20 | VM30 | VM33 | VM31 | VM32 | VM40 VM41 | VM21 | VM55 |
|---|--------------|------|------|------|------|------|--------------|------|------|
| STIL VTIČA / PLUG STYLE | | | | | | | | | |
| nemški / German  | • | | | | • | • | | | • |
| francoski / French  | • | | | | • | • | • | | • |
| italijanski / Italian S11  | | | • | • | • | • | | | • |
| italijanski / Italian S17  | | | • | | • | | | | • |
| euro  | • | • | • | | • | • | • | • | • |

 UJEMANJE VTIČNIC IN VTIČEV
 SOCKETS AND PLUGS MATCHING

| VTIČNICA / SOCKET | VM21 | VM52 | VM55 |
|--|------|------|------|
| STIL VTIČA / PLUG STYLE | | | |
| ameriški / American  | • | | • |
| britanski / British BS 1363-2  | | • | • |

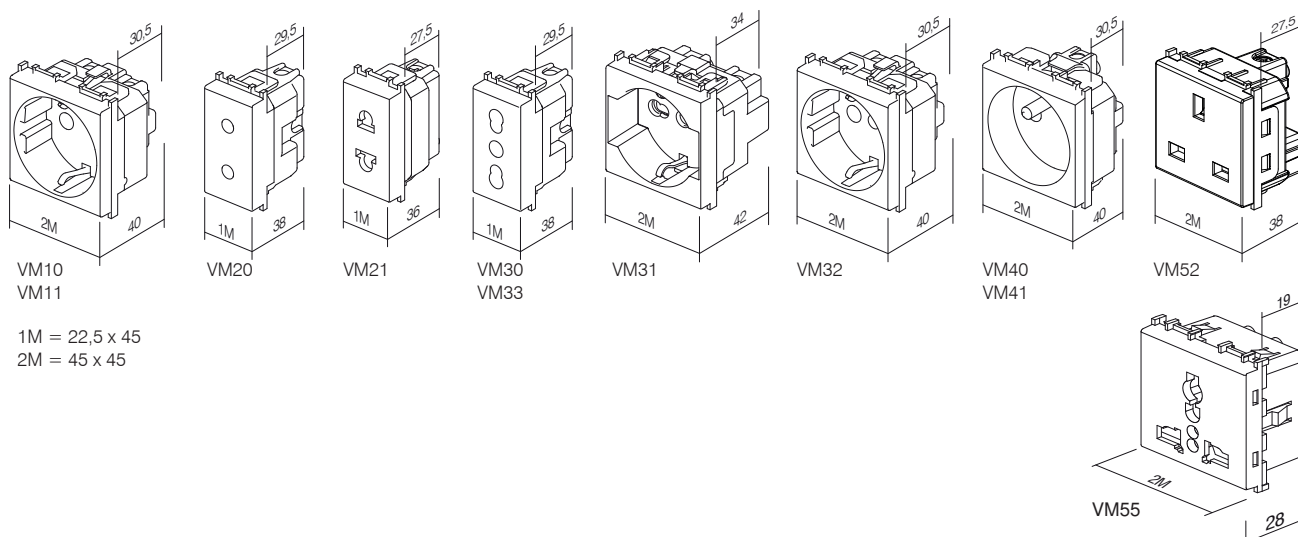



| tip type | naziv description | tehnični opis technical data | velikost size | barva colour |
|-------------|--|---------------------------------|------------------|---|
| KM10 | VTIČNICA TV OSNOVNA SOCKET TV BASIC | 0dB | 1M | <input type="checkbox"/> PW bela-sijaj polar white |
| KM11 | VTIČNICA TV KONČNA SOCKET TV END-LINE | 1dB | 1M | <input type="checkbox"/> MW bela- mat matte white |
| KM12 | VTIČNICA TV PREHODNA SOCKET TV TROUGHPASS | 10dB | 1M | <input checked="" type="checkbox"/> SB črna-mat soft touch black |
| : | : | : | : | <input type="checkbox"/> AT antracit anthracite |
| : | : | : | : | <input type="checkbox"/> ES srebrna-mat elox silver |
| : | : | : | : | <input type="checkbox"/> IW bež-sijaj ivory white |

VTIČNICA TV OSNOVNA 0dB 1M



- KM10PW
- KM10MW
- KM10SB
- KM10AT
- KM10ES
- KM10IW

- TV osnovna
- dušenje 0dB
- konektor zadaj – F standard
SOCKET TV BASIC 0dB 1M
- TV basic
- reduction 0dB
- back connector – F standard



VTIČNICA TV OSNOVNA 0dB 2M

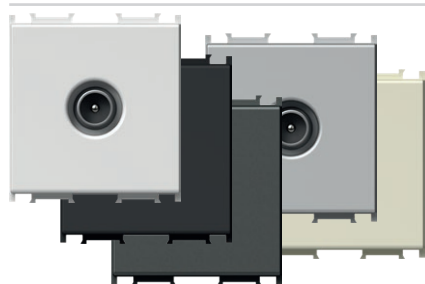

- KM20PW
- KM20MW
- KM20SB
- KM20AT
- KM20ES
- KM20IW

- TV osnovna
- dušenje 0dB
- konektor zadaj – F standard
SOCKET TV BASIC 0dB 2M
- TV basic
- reduction 0dB
- back connector – F standard



VTIČNICA TV KONČNA 1dB 1M



- KM11PW
- KM11MW
- KM11SB
- KM11AT
- KM11ES
- KM11IW

- TV končna
- frekvenčni pas 5÷2400 MHz
- dušenje < 1 dB
- ustreza EN 50083-1
- vijačna priključitev
SOCKET TV END-LINE 1dB 1M
- TV end-line
- frequency range 5÷2400 MHz
- reduction < 1 dB
- in accordance with EN 50083-1
- screw contacts

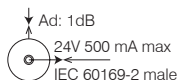

VTIČNICA TV PREHODNA 10dB 1M

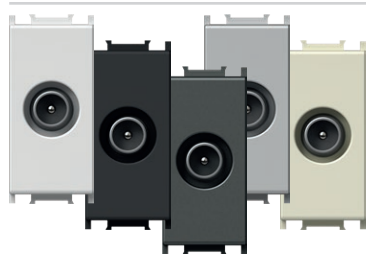

- KM12PW
- KM12MW
- KM12SB
- KM12AT
- KM12ES
- KM12IW

- TV prehodna
- frekvenčni pas 5÷2400 MHz
- dušenje < 10 dB
- ustreza EN 50083-1
- vijačna priključitev
SOCKET TV TROUGHPASS 10dB 1M
- TV troughpass
- frequency range 5÷2400 MHz
- reduction < 10 dB
- in accordance with EN 50083-1
- screw contacts

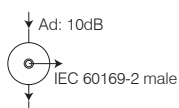

VTIČNICA SAT OSNOVNA 0dB 1M



- KM15PW
- KM15MW
- KM15SB
- KM15AT
- KM15ES
- KM15IW

- SAT osnovna
- dušenje 0dB
- konektor zadaj – F standard
- SOCKET SAT BASIC 0dB 1M*
- SAT basic
- reduction 0dB
- back connector – F standard



VTIČNICA SAT OSNOVNA 0dB 2M

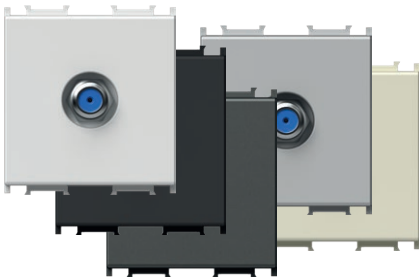

- KM24PW
- KM24MW
- KM24SB
- KM24AT
- KM24ES
- KM24IW

- SAT osnovna
- dušenje 0dB
- konektor zadaj – F standard
- SOCKET SAT BASIC 0dB 2M*
- SAT basic
- reduction 0dB
- back connector – F standard



VTIČNICA SAT KONČNA 1dB 1M

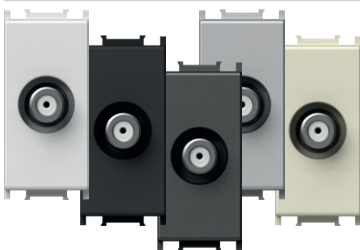

- KM16PW
- KM16MW
- KM16SB
- KM16AT
- KM16ES
- KM16IW

- SAT končna
- frekvenčni pas 5÷2400 MHz
- dušenje < 1dB
- ustreza EN 50083-1
- vijajna priključitev
- SOCKET SAT END-LINE 1dB 1M*
- SAT end-line
- frequency range 5÷2400 MHz
- reduction < 1dB
- in accordance with EN 50083-1
- screw contacts

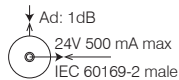

VTIČNICA R OSNOVNA 0dB 1M



- KM19PW
- KM19MW
- KM19SB
- KM19AT
- KM19ES
- KM19IW

- R osnovna
- dušenje 0dB
- konektor zadaj – F standard
- SOCKET R BASIC 0dB 1M*
- R basic
- reduction 0dB
- back connector – F standard



VTIČNICA R OSNOVNA 0dB 2M

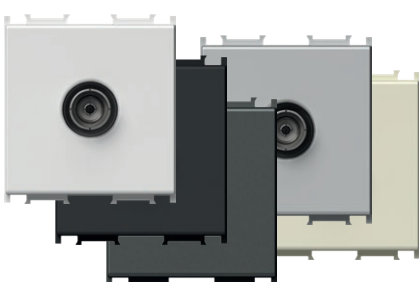

- KM29PW
- KM29MW
- KM29SB
- KM29AT
- KM29ES
- KM29IW

- R osnovna
- dušenje 0dB
- konektor zadaj – F standard
- SOCKET R BASIC 0dB 2M*
- R basic
- reduction 0dB
- back connector – F standard



VTIČNICA SAT-TV KONČNA 1dB 2M

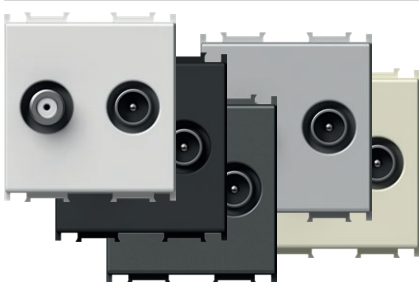

- KM25PW
- KM25MW
- KM25SB
- KM25AT
- KM25ES
- KM25IW

- SAT-TV končna
- frekvenčni pas 5÷2400 MHz
- dušenje < 1dB
- ustreza EN 50083-1
- vijajna priključitev
- SOCKET SAT-TV END-LINE 1dB 2M*
- SAT-TV end-line
- frequency range 5÷2400 MHz
- reduction < 1dB
- in accordance with EN 50083-1
- screw contacts

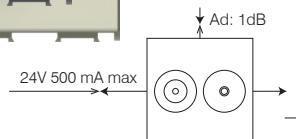

OSNOVNE VEZALNE SCHEME
BASIC CONNECTION SAMPLES

samostojna vezava
stand alone connection



KM10
KM20
KM11
KM15
KM24
KM16
KM19
KM29
KM25

zvezda vezava
star connection

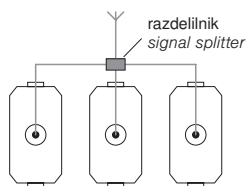

KM10
KM20
KM11
KM15
KM24
KM16
KM19
KM29
KM25

prehodna vezava
throughpass connection

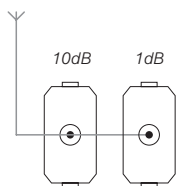

KM12 KM11



- KM22PW
- KM22MW
- KM22SB
- KM22AT
- KM22ES
- KM22IW

VTIČNICA AVDIO 2xRCA 1M

- avdio 2x RCA
- pritrditev vodnikov zadaj s spajkanjem

SOCKET AUDIO 2xRCA 1M

- audio 2x RCA
- soldering connection of cable at the back side



- KM23PW
- KM23MW
- KM23SB
- KM23AT
- KM23ES
- KM23IW

VTIČNICA AVDIO ZVOČNIŠKA 1M

- avdio 2x Ø4mm
- za priklop zvočniškega vodnika, vtiča Ø4mm ali viličastega kabel čevlja
- pritrditev vodnikov zadaj s spajkanjem

SOCKET AUDIO LOUDSPEAKERS 1M

- audio 2x Ø4mm
- to accommodate speaker wire, banana plug Ø4mm or spades
- soldering connection of cable at the back side



- KM26PW
- KM26MW
- KM26SB
- KM26AT
- KM26ES
- KM26IW

VTIČNICA AVDIO ZVOČNIŠKA 2M

- avdio 2x Ø4mm
- za priklop zvočniškega vodnika, vtiča Ø4mm ali viličastega kabel čevlja
- pritrditev vodnikov zadaj s spajkanjem

SOCKET AUDIO LOUDSPEAKERS 2M

- audio 2x Ø4mm
- to accommodate speaker wire, banana plug Ø4mm or spades
- soldering connection of cable at the back side



1M = 22,5 x 45
2M = 45 x 45

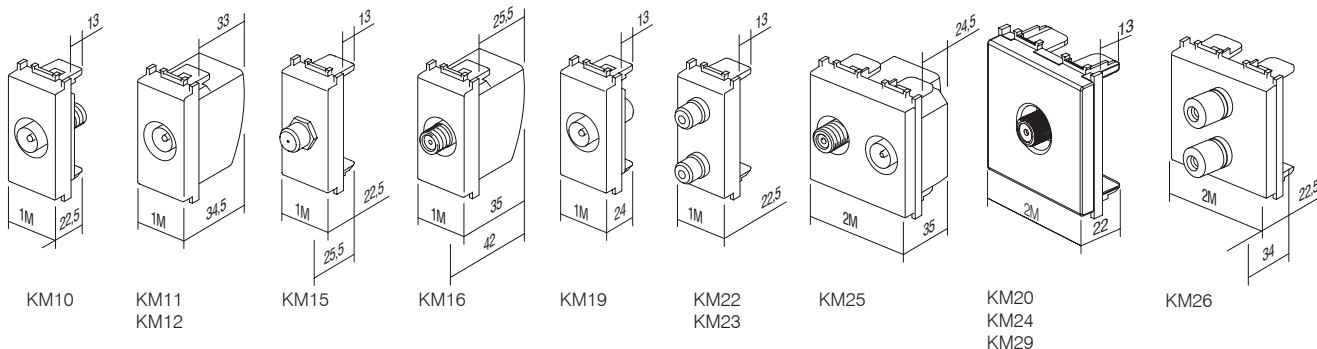

VTIČNICA TEL LT RJ11 6/4 1M



- KM30PW
- KM30MW
- KM30SB
- KM30AT
- KM30ES
- KM30IW

- TEL LT vijak
- RJ11 6/4
- ustreza IEC 60603-7
- vijačna pritrditev vodnikov

SOCKET TEL LT RJ11 6/4 1M

- TEL LT screw
- RJ11 6/4
- in accordance with IEC 60603-7
- screw contacts



VTIČNICA TEL BT SEC 6/6 1M

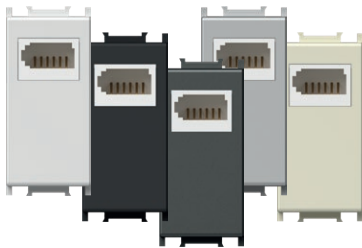

- KM31PW
- KM31MW
- KM31SB
- KM31AT
- KM31ES
- KM31IW

- TEL BT britanski standard
- SEC sekundarna 6/6
- ustreza BS 6312
- vijačna pritrditev vodnikov

SOCKET TEL BT SEC 6/6 1M

- TEL BT British standard
- SEC secondary 6/6
- in accordance with BS 6312
- screw contacts



VTIČNICA TEL KS RJ11 6/4 1M

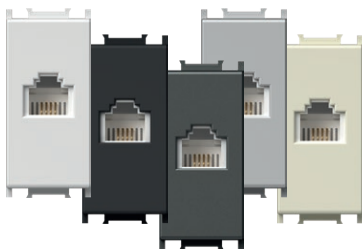

- KM36PW
- KM36MW
- KM36SB
- KM36AT
- KM36ES
- KM36IW

- KS keystone pritrditveni standard
- RJ11 6/4
- ustreza IEC 60603-7

SOCKET TEL KS RJ11 6/4 1M

- KS keystone fixing standard
- RJ11 6/4
- in accordance with IEC 60603-7

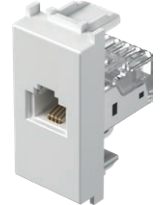

VTIČNICA CAT5e KS RJ45 8/8 1M

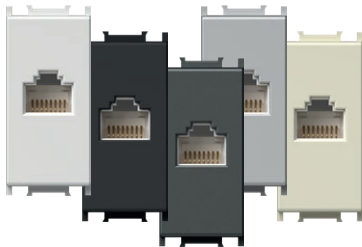

- KM37PW
- KM37MW
- KM37SB
- KM37AT
- KM37ES
- KM37IW

- KS keystone pritrditveni standard
- CAT5e, RJ45 8/8
- ustreza IEC 60603-7

SOCKET CAT5e KS RJ45 8/8 1M

- KS keystone fixing standard
- CAT5e, RJ45 8/8
- in accordance with IEC 60603-7

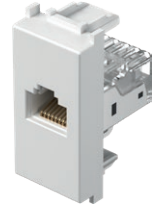

ADAPTER KS 1M

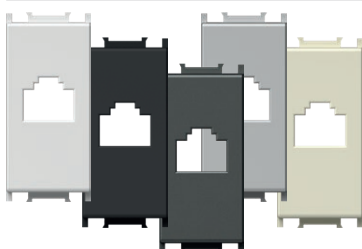

- KM35PW
- KM35MW
- KM35SB
- KM35AT
- KM35ES
- KM35IW

- KS keystone pritrditveni standard
- AMP, Avaya, Brandrex, FMT, Mfico, Tyco, ...
- komunikacijski modul ni vgrajen

ADAPTER KS 1M

- KS keystone fixing standard
- AMP, Avaya, Brandrex, FMT, Mfico, Tyco, ...
- communication module not included



ADAPTER KS S PRAŠNO ZAŠČITO 1M

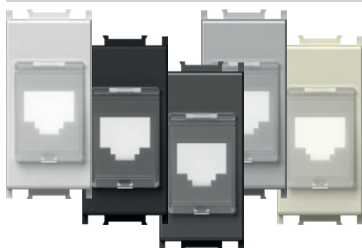

- KM38PW
- KM38MW
- KM38SB
- KM38AT
- KM38ES
- KM38IW

- KS keystone pritrditveni standard s protiprašnim pokrovom
- AMP, Avaya, Brandrex, FMT, Mfico, Tyco, ...
- komunikacijski modul ni vgrajen

ADAPTER KS WITH DUST PROTECTION 1M

- KS keystone fixing standard with dust protection
- AMP, Avaya, Brandrex, FMT, Mfico, Tyco, ...
- communication module not included



VTIČNICA CAT6 SCH KS RJ45 8/8 1M

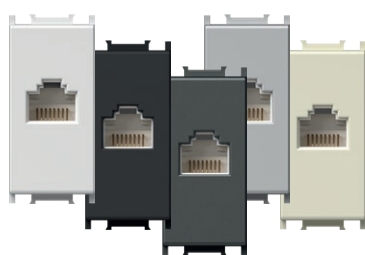

- KM39PW
- KM39MW
- KM39SB
- KM39AT
- KM39ES
- KM39IW

- KS keystone pritrditveni standard
- CAT6 UTP toolless, RJ45 8/8
- ustreza ISO/IEC 11801

SOCKET CAT6 SCH KS RJ45 8/8 1M

- KS keystone fixing standard
- CAT6 UTP toolless, RJ45 8/8
- in accordance with ISO/IEC 11801



ADAPTER KS UNIVERZALNI 1M

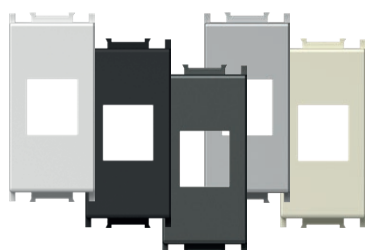

- KM50PW
- KM50MW
- KM50SB
- KM50AT
- KM50ES
- KM50IW

- KS keystone pritrditveni standard
- primeren za HDMI, USB
- komunikacijski modul ni vgrajen

ADAPTER KS UNIVERSAL 1M

- KS keystone fixing standard
- suitable for HDMI, USB
- communication module not included



ADAPTER PD 1M

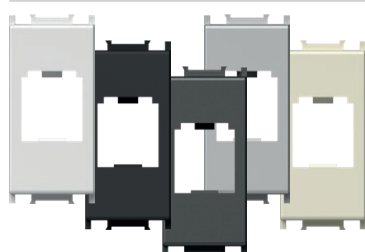

- KM40PW
- KM40MW
- KM40SB
- KM40AT
- KM40ES
- KM40IW

- PD Panduit Mini-COM pritrditveni standard
- komunikacijski modul ni vgrajen

ADAPTER PD 1M

- PD Panduit Mini-COM fixing standard
- communication module not included



ADAPTER PD S PRAŠNO ZAŠČITO 1M



- KM43PW
- KM43MW
- KM43SB
- KM43AT
- KM43ES
- KM43IW

- PD Panduit Mini-COM pritrditveni standard s protiprašnim pokrovom
- komunikacijski modul ni vgrajen

ADAPTER PD WITH DUST PROTECTION 1M

- PD Panduit Mini-COM fixing standard with dust protection
- communication module not included



ADAPTER R&M 1M

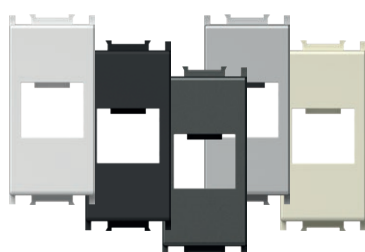

- KM46PW
- KM46MW
- KM46SB
- KM46AT
- KM46ES
- KM46IW

- R&M pritrditveni standard
- komunikacijski modul ni vgrajen

ADAPTER R&M 1M

- R&M fixing standard
- communication module not included



ADAPTER R&M CAT6A 1M

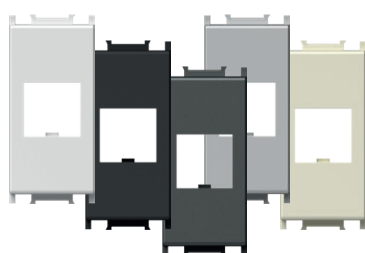

- KM52PW
- KM52MW
- KM52SB
- KM52AT
- KM52ES
- KM52IW

- R&M pritrditev za CAT6A
- komunikacijski modul ni vgrajen

ADAPTER R&M CAT6A 1M

- R&M fixing for CAT6A
- communication module not included





- KM47PW
- KM47MW
- KM47SB
- KM47AT
- KM47ES
- KM47IW

ADAPTER R&M S PRAŠNO ZAŠČITO 1M

- R&M pritrditveni standard s protiprašnim pokrovom
- komunikacijski modul ni vgrajen

ADAPTER R&M WITH DUST PROTECTION 1M

- R&M fixing standard with dust protection
- communication module not included



- KM53PW
- KM53MW
- KM53SB
- KM53AT
- KM53ES
- KM53IW

ADAPTER R&M CAT6A S PRAŠNO ZAŠČITO 1M

- R&M pritrditev za CAT6A s protiprašnim pokrovom
- komunikacijski modul ni vgrajen

ADAPTER R&M CAT6A WITH DUST PROTECTION 1M

- R&M fixing for CAT6A with dust protection
- communication module not included



ADAPTER LK 1M

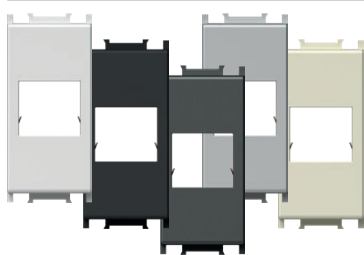

- KM45PW
- KM45MW
- KM45SB
- KM45AT
- KM45ES
- KM45IW

- LK LeoniKerpen eLine / BKS NewLine pritrditveni standard
- komunikacijski modul ni vgrajen

ADAPTER LK 1M

- LK LeoniKerpen eLine / BKS NewLine fixing standard
- communication module not included



ADAPTER NEXANS/SCHRACK 2M

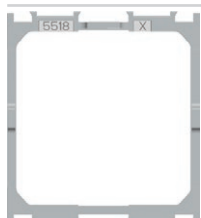

KA26

- adapter za pritrditev modulov Nexans LANmark in Schrack velikosti 45x45mm
- primerna za Nexans tip N423.540N
- primeren za Schrack tip HSEMD02W2F
- komunikacijski modul ni vgrajen

ADAPTER NEXANS/SCHRACK 2M

- fixing adapter for Nexans LANmark and Schrack module 45x45mm
- suitable for Nexans type N423.540N
- suitable for Schrack type HSEMD02W2F
- communication module not included

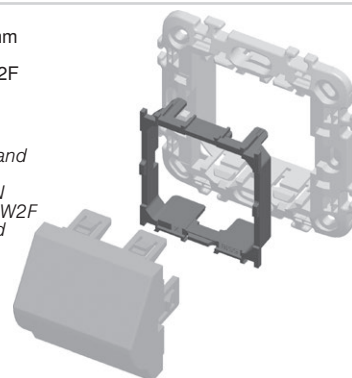

ADAPTER AT&T SYSTIMAX S PRAŠNO ZAŠČITO 1M

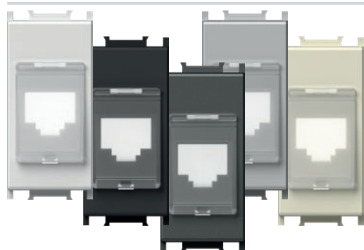

- KM48PW
- KM48MW
- KM48SB
- KM48AT
- KM48ES
- KM48IW

- AT&T Systimax pritrditveni standard s protiprašnim pokrovom
- komunikacijski modul ni vgrajen

ADAPTER AT&T SYSTIMAX WITH DUST PROTECTION 1M

- AT&T Systimax fixing standard with dust protection
- communication module not included



VTIČNICA USB TIP A 1M



- KM51PW
- KM51MW
- KM51SB
- KM51AT
- KM51ES
- KM51IW

- USB 2.0 vtičnica tip A
- vijajna pritrditev vodnikov, raster 5 mm, 1,5 mm², 1x2P + 1x3P
- ožičenje:
PIN 1 – VCC (+5V, rdeča žica)
PIN 2 – signal - (bela žica)
PIN 3 – signal + (zelena žica)
PIN 4 – GND - masa (črna žica)
S – oklop
- ustreza direktivi 2011/95/EU (RoHS2)

SOCKET USB TYPE A 1M

- USB 2.0 socket type A
- screw contacts, raster 5 mm, 1,5 mm², 1x2P + 1x3P
- wiring:
PIN 1 – VCC (+5V, red wire)
PIN 2 – Data - (white wire)
PIN 3 – Data + (green wire)
PIN 4 – GND - ground (black wire)
S – shield
- in accordance with directive 2011/95/EU (RoHS2)



1M = 22,5 x 45
2M = 45 x 45

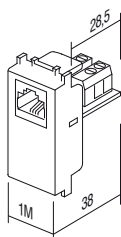

KM30

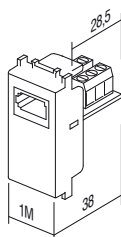

KM31

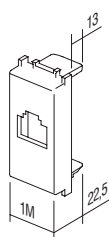

KM35
KM38
KM48

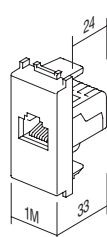

KM36
KM37
KM39

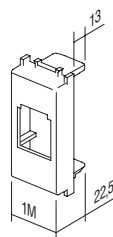

KM40
KM43

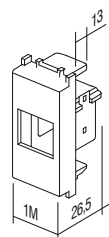

KM45

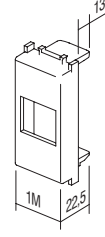

KM46
KM47
KM50
KM52
KM53

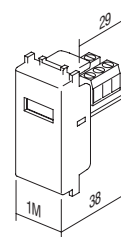

KM51



KA10

| tip type | naziv description | tehnični opis technical data |
|-------------|---|---------------------------------|
| KA10 | KONEKTOR KS CAT3 CONNECTOR KS CAT3 | RJ11 6/4 |
| KA11 | KONEKTOR KS CAT5e CONNECTOR KS CAT5e | RJ45 8/8 |
| KA12 | KONEKTOR KS CAT5eS CONNECTOR KS CAT5eS | RJ45 8/8 |
| ⋮ | ⋮ | ⋮ |



| KONEKTOR KS CAT3 RJ11 6/4 | |
|---------------------------|---|
| KA10 | <ul style="list-style-type: none"> - KS keystone pritrditveni standard - CAT3, RJ11 6/4 - ustreza IEC 60603-7 <p><i>CONNECTOR KS CAT3 RJ11 6/4</i></p> <ul style="list-style-type: none"> - KS keystone fixing standard - CAT3, RJ11 6/4 - in accordance with IEC 60603-7 |



| KONEKTOR KS CAT5e RJ45 8/8 | |
|----------------------------|--|
| KA11 | <ul style="list-style-type: none"> - KS keystone pritrditveni standard - CAT5e, RJ45 8/8 - ustreza IEC 60603-7 <p><i>CONNECTOR KS CAT5e RJ45 8/8</i></p> <ul style="list-style-type: none"> - KS keystone fixing standard - CAT5e, RJ45 8/8 - in accordance with IEC 60603-7 |



| KONEKTOR KS CAT5eS RJ45 8/8 | |
|-----------------------------|---|
| KA12 | <ul style="list-style-type: none"> - KS keystone pritrditveni standard - CAT5eS, RJ45 8/8 - ustreza IEC 60603-7 <p><i>CONNECTOR KS CAT5eS RJ45 8/8</i></p> <ul style="list-style-type: none"> - KS keystone fixing standard - CAT5eS, RJ45 8/8 - in accordance with IEC 60603-7 |



| KONEKTOR KS CAT6 SCH RJ45 8/8 | |
|-------------------------------|---|
| KA15 | <ul style="list-style-type: none"> - KS keystone pritrditveni standard - CAT6 UTP toolless, RJ45 8/8 - ustreza ISO/IEC 11801 <p><i>CONNECTOR KS CAT6 SCH RJ45 8/8</i></p> <ul style="list-style-type: none"> - KS keystone fixing standard - CAT6 UTP toolless, RJ45 8/8 - in accordance with ISO/IEC 11801 |



| KONEKTOR KS CAT6S SCH RJ45 8/8 | |
|--------------------------------|--|
| KA16 | <ul style="list-style-type: none"> - KS keystone pritrditveni standard - CAT6S STP toolless, RJ45 8/8 - ustreza ISO/IEC 11801 <p><i>CONNECTOR KS CAT6S SCH RJ45 8/8</i></p> <ul style="list-style-type: none"> - KS keystone fixing standard - CAT6S STP toolless, RJ45 8/8 - in accordance with ISO/IEC 11801 |



| KONEKTOR KS CAT6a SCH RJ45 8/8 | |
|--------------------------------|--|
| KA17 | <ul style="list-style-type: none"> - KS keystone pritrditveni standard - CAT6a STP toolless, RJ45 8/8 - ustreza ISO/IEC 11801 <p><i>CONNECTOR KS CAT6a SCH RJ45 8/8</i></p> <ul style="list-style-type: none"> - KS keystone fixing standard - CAT6a STP toolless, RJ45 8/8 - in accordance with ISO/IEC 11801 |



KA18

KONEKTOR SLIM KS CAT6S SCH RJ45 8/8

- KS keystone pritrditveni standard
- slim verzija
- CAT6S STP toolless, RJ45 8/8
- ustreza ISO/IEC 11801
- primeren tudi za dvojni adapter KE46

CONNECTOR SLIM KS CAT6S SCH RJ45 8/8

- KS keystone fixing standard
- slim style
- CAT6S STP toolless, RJ45 8/8
- in accordance with ISO/IEC 11801
- suitable also for KE46 double adapter



KA27

KONEKTOR KS HDMI

- KS keystone pritrditveni standard
- samo v kombinaciji z adapterjem KM50
- HDMI/HDMI

CONNECTOR KS HDMI

- KS keystone fixing standard
- only in combination with adapter KM50
- HDMI/HDMI



KA28

KABEL KS HDMI

- KS keystone pritrditveni standard
- samo v kombinaciji z adapterjem KM50
- HDMI/HDMI

CABLE KS HDMI

- KS keystone fixing standard
- only in combination with adapter KM50
- HDMI/HDMI



EM31



PW



| tip type | naziv description | tehnični opis technical data | velikost size | barva colour | |
|-------------|--|---------------------------------|------------------|--|--|
| EM12 | ZATEMNILNIK ROTACIJSKI MENJALNI DIMMER ROTATIVE 2WAY | RL 300W | 1M | <input type="checkbox"/> PW bela-sijaj polar white <input type="checkbox"/> MW bela-mat matte white <input type="checkbox"/> SB črna-mat soft touch black <input type="checkbox"/> AT antracit anthracite <input type="checkbox"/> ES srebrna-mat elox silver <input type="checkbox"/> IW bež-sijaj ivory white | <input type="checkbox"/> BL modra blue <input type="checkbox"/> RD rdeča red <input type="checkbox"/> GR zelena green <input type="checkbox"/> OR oranžna orange <input type="checkbox"/> RG rdeča/zelena red/green |
| EM23 | ZATEMNILNIK VGRADNI DIMMER INBOX | R (250 W), (RC,RL 200VA) | / | | |
| . | . | . | . | | |
| . | . | . | . | | |

ZATEMNILNIK ROTACIJSKI/MENJALNI RL 300 W 1M



- EM12PW
- EM12MW
- EM12SB
- EM12AT
- EM12ES
- EM12IW

- rotacijski z menjalnim stikalom
- breme RL, 40W - 300W
- napajanje 230V~ 50Hz
- možna vezava z menjalnim stikalom
- montaža več naprav skupaj v eno dozo dovoljena samo pod pogojem, da njihovo skupno maksimalno breme ne presega maksimalne moči enega zatemnilnika
- v istem tokokrogu je dovoljena uporaba samo enega zatemnilnega stikala
- varovalka ni vgrajena – potrebna vezava zunanje varovalke
- ustreza EN 60669-1
- vijalni kontakti - 1.5-2.5mm²
- vgrajena LED indikacija stopnje zatemnitve



DIMMER ROTATIVE/2WAY RL 300W 1M

- rotation control with 2-way switch
- load RL, 40W - 300W
- supply voltage 230V~ 50Hz
- 2-way switch combination is possible
- installing several devices together in one box is only permitted if their total maximum load does not exceed the maximum power of a single dimmer
- one circuit allows the use of only one dimmer
- no built-in fuse – external fuse must be used
- in accordance with EN 60669-1
- screw contacts - 1.5-2.5mm²
- integrated LED indication of dimming level

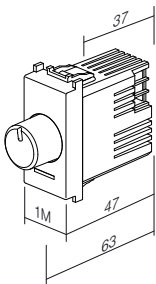

ZATEMNILNIK ROTACIJSKI/MENJALNI LED 60 W 1M



- EM13PW
- EM13MW
- EM13SB
- EM13AT
- EM13ES
- EM13IW

- rotacijski z menjalnim stikalom
- bremena: LED, 0 – 60 W (max. 6 LED zatemnilnih sijalk)
GLS, 0 – 60 W
- napajanje 230V~ 50Hz
- možna vezava z menjalnim stikalom
- montaža več naprav skupaj v eno dozo dovoljena samo pod pogojem, da njihovo skupno maksimalno breme ne presega maksimalne moči enega zatemnilnika
- v istem tokokrogu je dovoljena uporaba samo enega zatemnilnega stikala
- varovalka ni vgrajena – potrebna vezava zunanje varovalke
- ustreza IEC60669-2-1
- vijalni kontakti - 1.5-2.5mm²

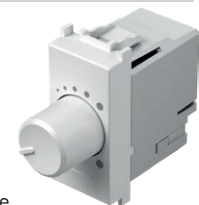

DIMMER ROTATIVE/2WAY LED 60W 1M

- rotation control with 2-way switch
- loads: LED, 0 – 60W (max. 6 dimmable LED lamps)
GLS, 0 – 60W
- supply voltage 230V~ 50Hz
- 2-way switch combination is possible
- installing several devices together in one box is only permitted if their total maximum load does not exceed the maximum power of a single dimmer
- one circuit allows the use of only one dimmer
- no built-in fuse – external fuse must be used
- in accordance with IEC60669-2-1
- screw contacts - 1.5-2.5mm²

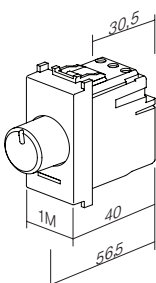

ZATEMNILNIK ROTACIJSKI/MENJALNI LED 180 W 1M



- EM14PW
- EM14MW
- EM14SB
- EM14AT
- EM14ES
- EM14IW

- rotacijski z menjalnim stikalom
- bremena:
 - LED, 0 – 180 W (max. 20 LED zatemnilnih sijalk)
 - GLS, 0 – 180 W
- napajanje 230V~ 50Hz
- možna vezava z menjalnim stikalom
- montaža več naprav skupaj v eno dozo dovoljena samo pod pogojem, da njihovo skupno maksimalno breme ne presega maksimalne moči enega zatemnilnika
- v istem tokokrogu je dovoljena uporaba samo enega zatemnilnega stikala
- varovalka ni vgrajena – potrebna vezava zunanje varovalke
- ustreza IEC60669-2-1
- vijaki kontakti - 1.5-2.5mm²

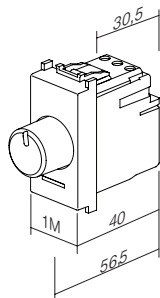

DIMMER ROTATIVE/2WAY LED 180W 1M

- rotation control with 2-way switch
- loads:
 - LED, 0 – 180W (max. 20 dimmable LED lamps)
 - GLS, 0 – 180W
- supply voltage 230V~ 50Hz
- 2-way switch combination is possible
- installing several devices together in one box is only permitted if their total maximum load does not exceed the maximum power of a single dimmer
- one circuit allows the use of only one dimmer
- no built-in fuse – external fuse must be used
- in accordance with IEC60669-2-1
- screw contacts - 1.5-2.5mm²

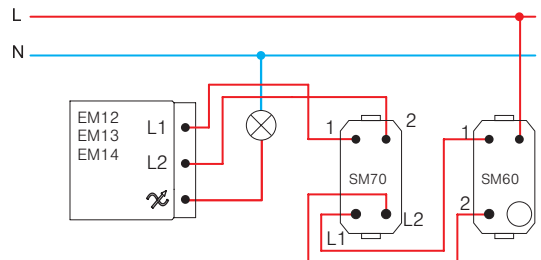
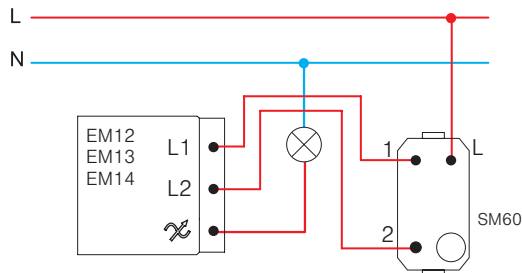
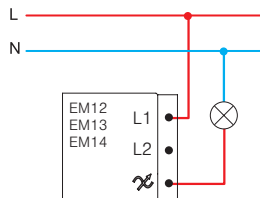

ZATEMNILNIK ROTACIJSKI R 250W 1M



- EM15PW
- EM15MW
- EM15SB
- EM15AT
- EM15ES
- EM15IW

- rotacijski brez stikala
- breme R, 40W - 250W
- napajanje 230V~ 50Hz
- vezava z menjalnim stikalom ni možna
- vezava več zatemnilnikov ni dovoljena
- ustreza EN 60669-1
- vijačna pritrditev vodnikov 1.5-2.5 mm²
- LED indikacija

DIMMER ROTATIVE R 250W 1M

- rotation control without switch
- load R, 40W - 250W
- supply voltage 230V~ 50Hz
- 2-way switch combination is not possible
- more dimmers combination is not allowed
- in accordance with EN 60669-1
- screw contacts 1.5-2.5mm²
- LED indication

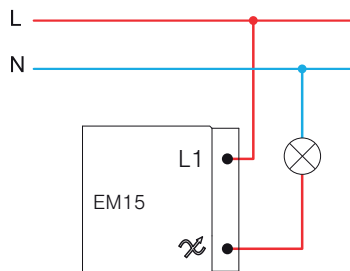
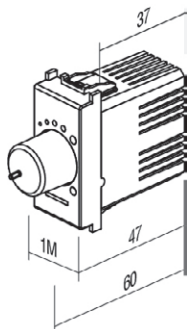



- EM16PW
- EM16MW
- EM16SB
- EM16AT
- EM16ES
- EM16IW

1-10 V ZATEMNILNIK ROTACIJSKI MENJALNI

- nominalna delovna napetost: 10VDC
- minimalna delovna napetost: 0,7VDC
- območje zatemnjevanja: 0,7% - 100% (odvisno od napajalnika in bremen)
- minimalni ponorni tok: 0,1mA
- maksimalni ponorni tok: 120mA
- maksimalna poraba: 0,35W
- prenapetostna zaščita: 15,8VDC do 250mA (nezamenljiva)
- največji pulzni tok: 3ADC
- vrsta bremen: 0-10V, 1-10V in PWM
- tip stikala: mehanski: potisni vklop/izklop
- ničelni vodnik: ni potreben
- nominalna delovna napetost: 100-240 VAC, 50-60 Hz
- maksimalni trenutni tok: 10A
- maksimalni delovni tok: 8A
- maksimalna obremenitev (pri 230 VAC): 1800VA (1800 x pf = max. W)
- izolacijska upornost: > 100MΩ pri 250 VAC
- prenapetostna in kratkostična zaščita: 10A, 350VAC (nezamenljiva)
- rotacijski kot: 270° ± 5°
- temperatura delovanja: -5 do 40°C
- temperatura skladiščenja: -30 do 80 °C
- maksimalna temperatura ohišja: 65°C
- maksimalna vlažnost: 90% (brez kondenzacije)
- EMC in imunost: CISPR 15(2008), IEC 61547
- LVD: IEC 60669-1:2017, IEC 60669-2-1:2015

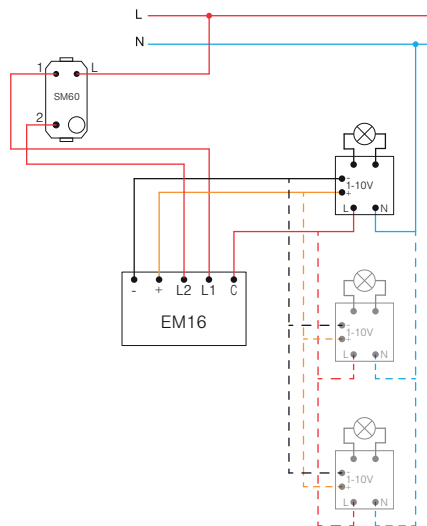
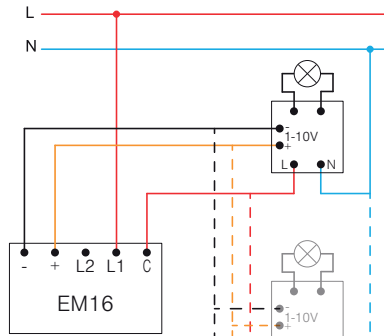
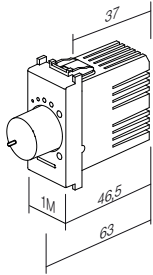
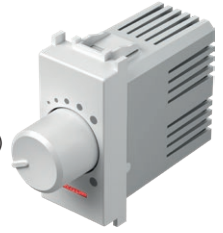

1-10 V DIMMER ROTARY TOGGLE

- nominal operating voltage: 10 VDC
- minimum operating voltage: 0.7 VDC
- dimming range: 0.7% - 100% (depending on power supply and loads)
- minimum sink current: 0.1 mA
- maximum consumption: 0.35 W
- surge protection: 15.8 VDC up to 250 mA (not replaceable)
- maximum pulse current: 3 ADC
- load types: 0-10 V, 1-10 V and PWM
- switch type: mechanical: push on/off
- zero cable: not required
- nominal operating voltage: 100-240 VAC, 50-60 Hz
- maximum instantaneous current: 10 A
- maximum operating current: 8 A
- maximum load (at 230 VAC): 1800 VA (1800 x pf = max. W)
- isolation resistance: > 100 MΩ at 250 VAC
- surge protection and Short-circuit protection: 10 A, 350 VAC (not replaceable)
- rotation angle: 270° ± 5°
- operating temperature: -5 to 40°C
- storing temperature: -30 to 80°C
- maximum housing temperature: 65°C
- maximum humidity: 90% (no condensation)
- EMC & immunity: CISPR 15(2008), IEC 61547
- LVD: IEC 60669-1:2017, IEC 60669-2-1:2015

ZATEMNILNIK VGRADNI R (250 W), (RC,RL 200VA)

EM23

- vgradni, za vezavo s tipkalom
- breme RLC 15-250W ali 15-200 VA
- napajanje 230 V~ 50Hz
- možna vezava več tipkal
- vezava več zatemnilnikov ni dovoljena
- vgrajena spominska funkcija
- funkcija mehkega vklopa/izklopa
- »leading edge«
- ustreza EN60669, EN60950, EN 61000, ETSI EN 300 220-1, ETSI EN 300 220-2
- vijačna pritrnitev vodnikov do preseka 2,5mm²

DIMMER INBOX R (250 W), (RC, RL 200 VA)

- inbox, controlled by external push button
- load RLC 15-250W or 15-200 VA
- supply voltage 230V~ 50Hz
- several push-buttons combinations are possible
- more dimmers combination is not allowed
- light intensity memory
- soft start/stop function
- »leading edge«
- in accordance with EN60669, EN60950, EN 61000, ETSI EN 300 220-1, ETSI EN 300 220-2
- screw contacts to wires 2,5 mm²

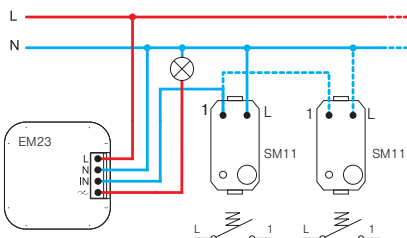
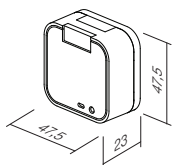

KRMILNI modul MZC za EM18

EM17

- MZC priklpite po vezalni shemi.
- možna vezava z več tipkali
- montaža samo ene naprave v eno dozo
- samo za notranjo uporabo
- napajanje: 230 V~ 50Hz
- maksimalna upornost žic: 50 kΩ
- maksimalen tok na enoto MZC: 10 mA
- število zatemnilnikov na MZC: 1-4
- maksimalno število MZC v vezavi: omejeno na varovalko v tokokrogu
- temperatura delovanja: -5 °C do 45 °C
- temperatura skladiščenja: -30 °C do 80 °C
- maksimalna vlažnost: 90 % (brez kondenziranja)
- dimenzije ohišja: 36 x 36 x 12 mm

MZC CONTROL Module for EM18

- Connect the MZC according to the wiring diagram.
- Possible wiring with several push buttons.
- Only one device installation per mounting box.
- For indoor use only.
- Power supply: 230V~ 50Hz
- Max. cable resistance: 50kΩ
- Max. current per MZC unit: 10mA
- Number of dimmers on MZC: 1-4
- Max. number of MZC in the wiring: limited to the fuse in the circuit
- Operating temperature: -5°C to 45°C
- Storage temperature: -30°C to 80°C
- Max. humidity: 90% (no condensation)
- Casing dimensions: 36x36x12 mm

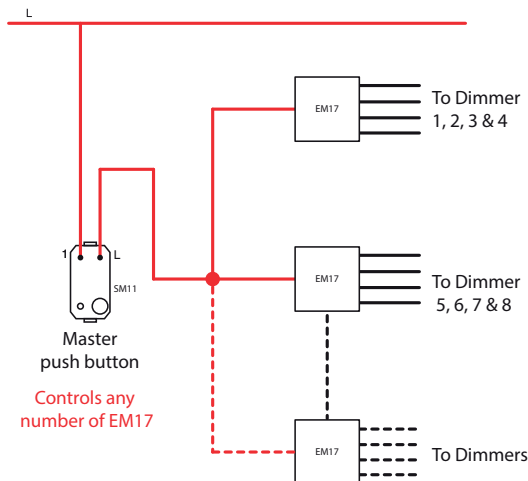
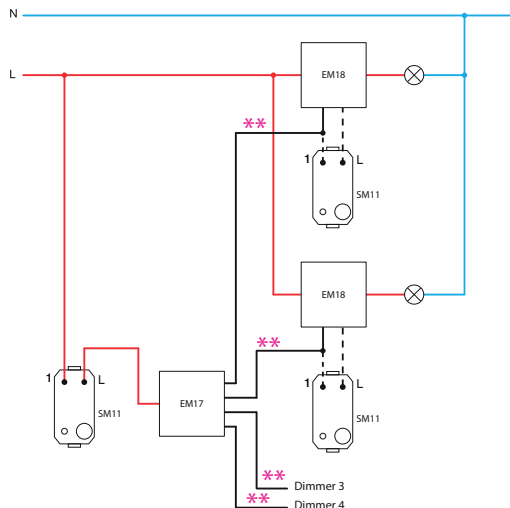
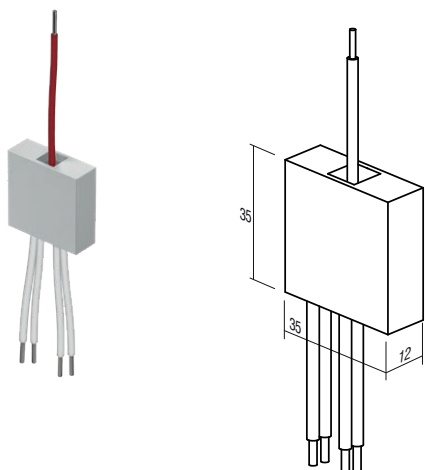

ZATEMNILNIK VGRADNI LED 250W

EM18

- vgradni, za vezavo s tipkalom
- za leading ali trailing edge
- napajanje 230 V~ 50 Hz
- možna vezava z več tipkali
- funkcija pomnjenja zadnje nastavitve, razen v primeru izpada napetosti
- funkcija mehkega vklopa/izklopa
- nastavitve minimalne svetilnosti
- montaža samo ene naprave v eno dozo
- samo za notranjo uporabo
- ustreza EN 60669-1 in EN 60669-2-1

DIMMER INBOX LED 250W

- inbox, controlled by external push button
- for leading or trailing edge
- supply voltage 230V~ 50Hz
- several push-buttons combinations is possible
- memory function of the last setting, except in the case of a power failure
- soft start / stop function
- minimum intensity control
- only one dimmer per wall box
- only for indoor usage
- in accordance with EN 60669-1 and EN 60669-2-1

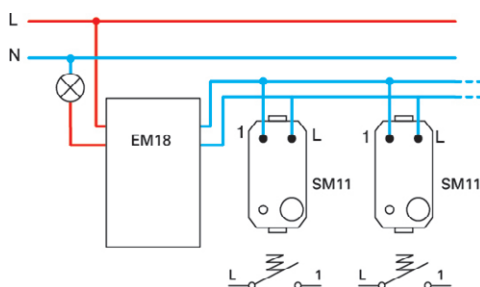
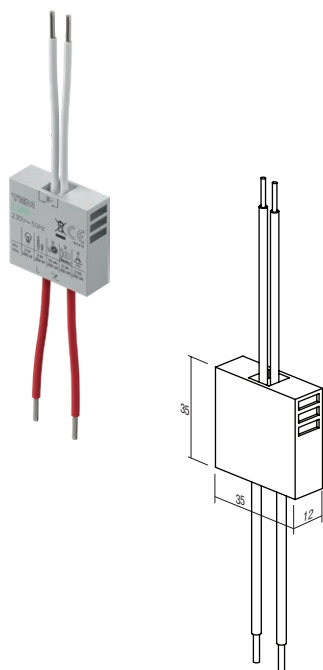

ZATEMNILNIK VGRADNI DC LED 96W

EM19

- vgradni, za vezavo s tipkalom
- vezava z vsemi LED napajalniki s konstantno napetostjo in nekaterimi LED napajalniki s konstantnim tokom, 9 – 48V DC, max 96W (tudi za LED trakove)
- ni za uporabo z induktivnimi bremen
- možna vezava z več tipkali in več zatemnilniki
- funkcija pomnjenja zadnje nastavitve, razen v primeru izpada napetosti
- funkcija mehkega vklopa / izklopa
- montaža samo ene naprave v eno dozo
- samo za notranjo uporabo

DIMMER INBOX DC LED 96W

- inbox, controlled by external push button
- for use with constant voltage LED drivers and some constant current LED drivers, 9-48V DC, max 96W (also for LED strips)
- not for use with inductive loads
- several push-buttons combinations and several dimmers is possible
- memory function of the last setting, except in the case of a power failure
- soft start / stop function
- only one dimmer per wall box
- only for indoor usage

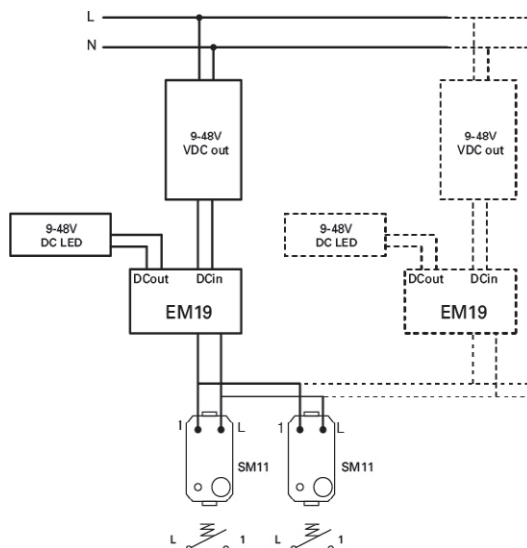
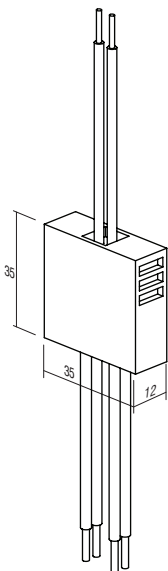

POZOR!

V primeru montaže več zatemnilnih stikal v isto dozo se za vsako dodatno zatemnilno stikalo zmanjša maksimalna skupna moč za 10%.

ATTENTION!

If more dimmers are connected in one box reduce maximum common power for 10% for each dimmer.

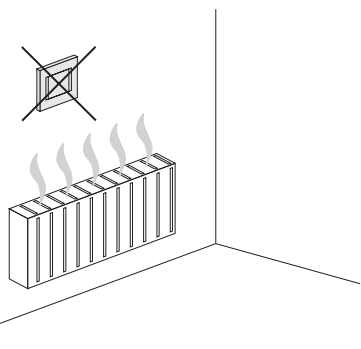

EM15 (40÷250W)

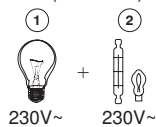

EM12 (40÷300W)

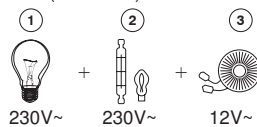

EM13 (0÷60W), EM14 (0÷180W), EM23 (15÷250W, 15÷200VA),

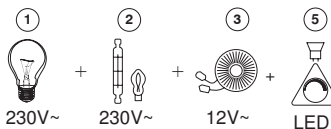

EM18 (2÷250VA)

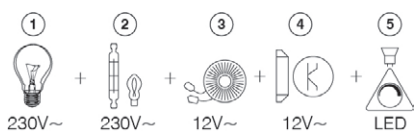

- 1 - žarnica z žarilno nitko / incandescent lamp
- 2 - halogenska žarnica / halogen lamp
- 3 - klasični transformator / classical transformer
- 4 - zatemnilni elektronski transformator / dimmable electronic transformer
- 5 - zatemnilna LED sijalka / dimmable LED lamp

STIKALO / ZATEMNILNIK UNIVERZALNI RLC 0-300W 2M

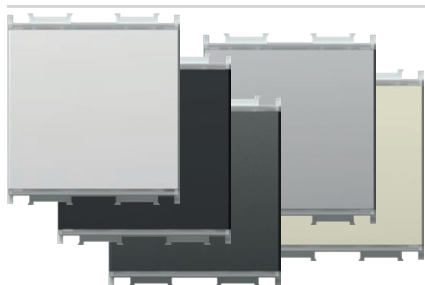

- EM25PW
- EM25MW
- EM25SB
- EM25AT
- EM25ES
- EM25IW



TOUCH EM25 je mikroprocesorsko voden elektronski zatemnilnik. Omogoča vklop, izklop in zatemnjevanje vseh zatemnilnih in nekaterih nezatemnilnih žarnic in sijalk. Vgrajeni mikroprocesor samodejno zazna vrsto sijalke in prilagodi režim delovanja. Ob izklopu si zapomni zadnjo nastavitve, saj ima vgrajeno spominsko funkcijo. Funkcija mehkega zagona podaljša življenjsko dobo sijalk. V tipko je vgrajena elegantna LED indikacija, z možnostjo izbire barve in nastavitve jakosti. Na EM25 lahko vežemo do 5 dodatnih upravljalnih tipkal EM26 (»slave«).

TOUCH EM25 is microprocessor controlled electronic light dimmer. It serves as switch and dimmer for dimmable and some of non-dimmable lamps. Integrated microprocessor automatically identifies the type of lamp and adjusts the operating mode. It remembers the level of dimming after switching off due to integrated memory function. Soft-start function extends the lamp service life. An elegant LED indication is integrated into the button and the option of choosing a colour and intensity level is provided. Optionally one can connect of up to 5 additional control tasters EM26 (»slave«).

- univerzalni elektronski zatemnilnik za vklop, izklop in zatemnjevanje vseh zatemnilnih žarnic in sijalk (klasične, halogenske, LED, CFL, ...)
- in nekaterih nezatemnilnih sijalk
- samodejno zazna vrsto sijalke in temu prilagodi režim delovanja
- z zatemnjevanjem se zmanjša poraba električne energije
- funkcija mehkega zagona podaljša življenjsko dobo sijalk
- upravljanje preko vgrajenih mikro-stikal
- vgrajena spominska funkcija - ob izklopu si zapomni nivo zatemnitve
- možna vezava do pet (5) dodatnih upravljalnih tipkal EM26
- vezava z menjalnimi stikali ni možna
- vgrajene zaščite pred kratkim stikom, pregrevanjem in preobremenitvijo
- napajanje 230V~ 50Hz
- vgrajena elegantna LED indikacija, z možnostjo nastavitve barve in jakosti
- omogoča zamenjavo klasičnega stikala – dvožična vezava⁽¹⁾
- s trožično vezavo dosežemo polno funkcionalnost zatemnilnika⁽²⁾
- ustreza EN 60669-1 in EN 60669-2-1
- vijajna pritrditev vodnikov 1.5mm² (maks. moment privitja vijakov 0,4 Nm)

SWITCH / DIMMER UNIVERSAL RLC 0-300W 2M

- universal electronic dimmer for ON/OFF switching and dimming of all dimmable lamps (classical, halogen, LED, CFL, ...) and some non-dimmable lamps
- automatic detection of lamp type and adjustment of operating mode
- reduction of energy consumption
- soft start function extends life of lamps
- controlled by build-in micro switches
- memory function included – memorizes brightness on turn-off
- up to five (5) additional control units EM26 can be connected
- connection with 2-way switch is not possible
- build-in short-circuit, overheating and overload protection
- supply voltage 230V~ 50Hz
- an elegant integrated LED indication with the option of setting colour and intensity.
- replacement of classical switch is possible at two-wire connection⁽¹⁾
- full functionality is achieved at three-wire connection⁽²⁾
- in accordance with EN 60669-1 and EN 60669-2-1
- screw contacts 1.5mm² (max. tightening torque 0.4Nm)

⁽¹⁾dvožična vezava
two-wire connection

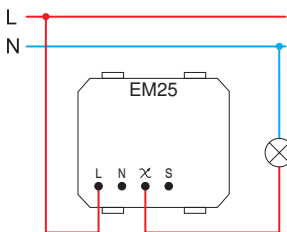

⁽²⁾trožična vezava
three-wire connection

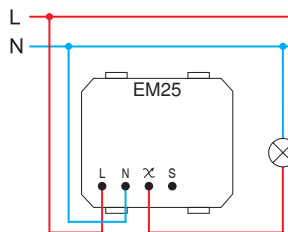

- dvožična vezava omogoča zatemnjevanje zatemnilnih žarnic in sijalk
- two-wire connection allows dimming of dimmable lamps

- trožična vezava omogoča zatemnjevanje zatemnilnih žarnic in sijalk in nekaterih nezatemnilnih LED in CFL sijalk
- three-wire connection allows dimming of dimmable lamps and some of non-dimmable LED and CFL lamps

| | 1 | 2 | 5 | 6 | 7 |
|------|-------|-------|--------|--------|--------|
| | | | | | |
| Min. | 40 W | 40 W | 40 VA | 40 VA | 40 VA |
| Max. | 300 W | 300 W | 300 VA | 100 VA | 100 VA |
| | (F) | (F) | (F) | | |

| | 1 | 2 | 4 | 6 | 7 | 8 | 9 |
|------|-------|-------|--------|--------|--------|--------|--------|
| | | | | | | | |
| Min. | 0 W | 0 W | 0 VA | 0 VA | 0 VA | 0 VA | 0 VA |
| Max. | 300 W | 300 W | 120 VA | 120 VA | 120 VA | 120 VA | 120 VA |
| | (F) | (F) | (F) | | | (F) | (F) |

- 1 - žarnica z žarilno nitko / incandescent lamp
- 2 - halogenska žarnica / halogen lamp

- 4 - zatemnilni elektronski transformator / dimmable electronic transformer
- 5 - klasični transformator / classical transformer

- 6 - zatemnilna varčna CFL sijalka / dimmable energy saving CFL lamp
- 7 - zatemnilna LED sijalka / dimmable LED lamp

- 8 - nezatemnilna varčna CFL sijalka / non-dimmable energy saving CFL lamp
- 9 - nezatemnilna LED sijalka / non-dimmable LED lamp

opombe / remarks

- (F) filter EM27
- priporočamo uporabo filtra EM27 / it is recommended to use filter EM27
- vse krmiljene žarnice in sijalke morajo biti enake / all controlled lamps must be the same
- tabela bremen velja za sijalke s faktorjem PF>0.5 / table of loads is valid for lamps with power factor PF>0.5

vklop in izklop ter zatemnjevanje luči /
on / off swithcing and dimming of lamp



vklop / izklop
kratek pritisk
on / off
short press

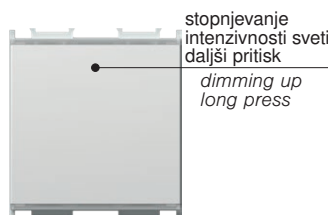

stopnjevanje
intenzivnosti svetila
daljši pritisk
dimming up
long press

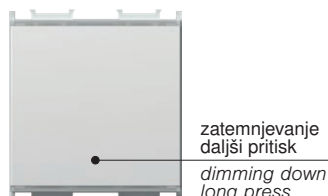

zatemnjevanje
daljši pritisk
dimming down
long press

izbira barve in nastavitev jakosti LED enote /
LED unit colour and intensity level selection

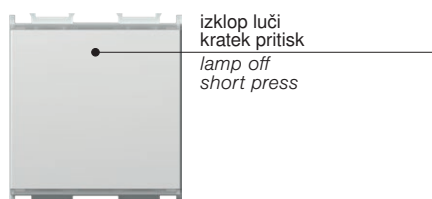

izklop luči
kratek pritisk
lamp off
short press



hkratni pritisk ~3s
vgrajena lučka 3x utripne
simultaneous press ~3s
integrated LED blinks 3
times



izbira barve
kratek pritisk
colour selection
short press

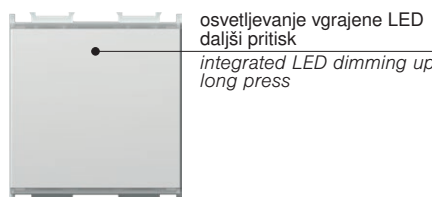

osvetljevanje vgrajene LED
daljši pritisk
integrated LED dimming up
long press



stopnjevanje intenzivnosti vgrajene LED enote
daljši pritisk
intensity escalation of the
integrated LED unit
long press

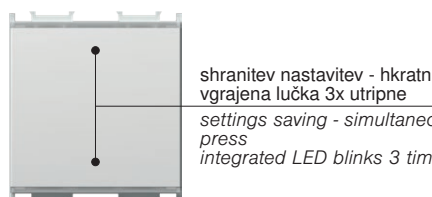

shranitev nastavitvev - hkratni kratek pritisk
vgrajena lučka 3x utripne
settings saving - simultaneous short
press
integrated LED blinks 3 times

*funkcija "RESET" /
"RESET" function



izklop luči
kratek pritisk
lamp off
short press

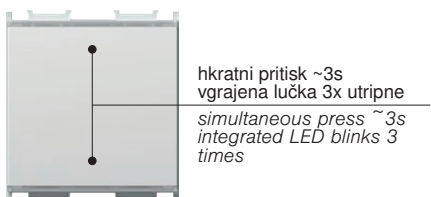

hkratni pritisk ~3s
vgrajena lučka 3x utripne
simultaneous press ~3s
integrated LED blinks 3
times

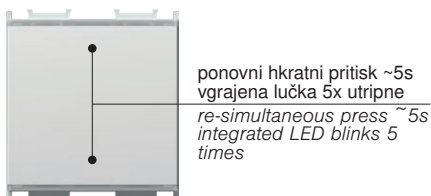

ponovni hkratni pritisk ~5s
vgrajena lučka 5x utripne
re-simultaneous press ~5s
integrated LED blinks 5
times

- * - priporočamo ob vgraditvi zatemnilnika in menjavi žarnic ali sijalk
- obvezno ob uporabi nezatemnilnih sijalk
- funkcija "RESET" pri uporabi dvožične vezave ne deluje
- možno samo pri EM25
- it is recommended at dimmer installation and lamp replacement
- mandatory when using non-dimmable lamps
- "RESET" function is not possible when using two-wire connection
- only possible on EM25

opozorila za vgradnjo /
installation precautions

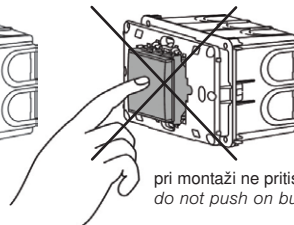
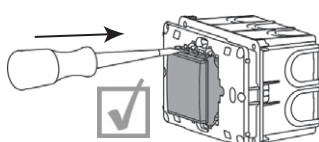
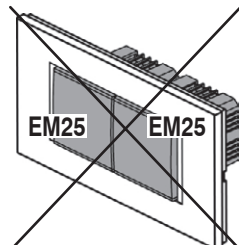
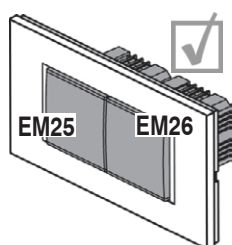

pri montaži ne pritisčaj na tipko /
do not push on button during mounting

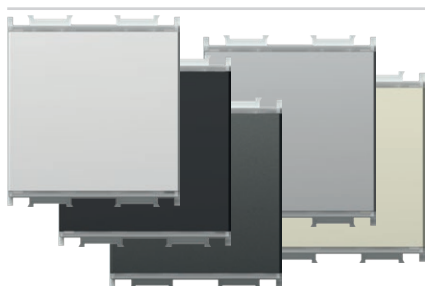

- EM26PW
- EM26MW
- EM26SB
- EM26AT
- EM26ES
- EM26IW

TIPKALO UPRAVLJALNO 2M

- v povezavi z univerzalnim zatemnilnikom EM25 omogoča upravljanje luči z več (do pet) lokacij z enako funkcionalnostjo kot EM25
- napajanje 230V ~ 50Hz
- ustreza EN 60669-1 in EN 60669-2-1
- vijačna pritrditev vodnikov 1.5mm² (maks. moment privitja vijakov 0,4 Nm)



PUSH-BUTTON CONTROL UNIT 2M

- connected to universal dimmer EM25 allows controlling of lamps with same functionality as EM25
- supply voltage 230V ~ 50Hz
- in accordance with EN 60669-1 and EN 60669-2-1
- screw contacts 1.5mm² (max. tightening torque 0.4Nm)

(1) dvožična vezava
two-wire connection

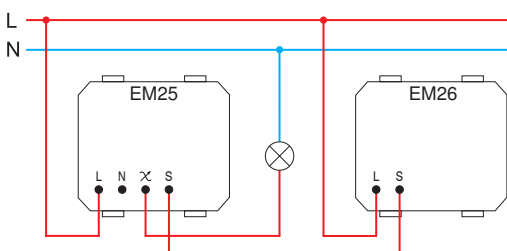

- dvožična vezava omogoča zatemnjevanje zatemnilnih žarnic in sijalk
- pri dvožični vezavi uporaba vsakega dodatnega upravljalnega tipkala poveča minimalno moč bremena za 25W

- two-wire connection allows dimming of dimmable lamps
- in a two-wire connection each additional control unit increases the minimum load by 25W

(2) trožična vezava
three-wire connection

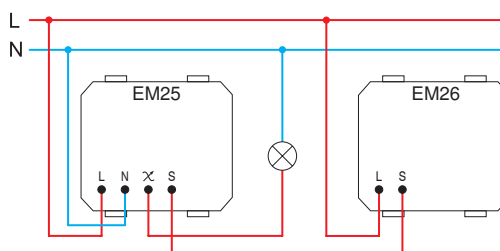

- trožična vezava omogoča zatemnjevanje zatemnilnih žarnic in sijalk in nekaterih nezatemnilnih LED in CFL sijalk

- three-wire connection allows dimming of dimmable lamps and some of non-dimmable LED and CFL lamps



EM27

FILTER OMREŽNIH MOTENJ

- filter frekvenčnih motenj za EM25
- slika je simbolična

FREQUENCY FILTER

- frequency filter for EM25
- image is symbolic

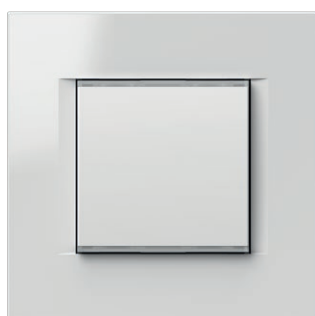
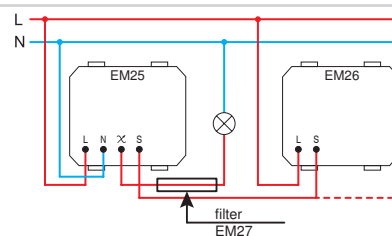

□ EM25PPOL20

SET STIKALO / ZATEMNILNIK UNIVERZALNI RLC 0-300W 2M PP OL20

- set vsebuje zatemnilnik EM25, nosilec 2M in okvir LINE 2M PW
- za tehnični opis glej EM25

SET SWITCH / DIMMER UNIVERSAL RLC 0-300W 2M PP OL20

- set includes dimmer EM25, mounting frame 2M and cover plate LINE 2M PW
- for technical details see EM25



2M = 45 x 45

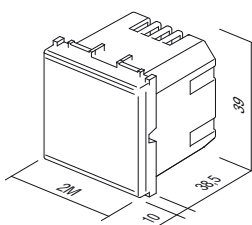

EM25
EM26

IR STIKALO 5A 230V~ 1M



- EM31PW
- EM31MW
- EM31SB
- EM31AT
- EM31ES
- EM31IW

- IR infrardeče stikalo
- napajanje: 230V~ ±10 % 50Hz
- rele: 5A / 250V~ (zero crossing)
- stopnja varnosti: IP40
- presek žic pri stičniku: 0,75 - 2,5 mm²
- kot zaznavanja: do 110° pri 20°C
- območje zaznavanja: približno 8 m pri 20°C
- nastavljenost časovnega trajanja: od približno 5 s do 12 min
- nastavljenost osvetlitve: od približno 5 do 200 LUX
- temperatura delovanja: od 0°C do +40°C
- ni primeren za vgradnjo v doze, globine 45 mm in ohišja CUBO IP20
- samo za notranjo uporabo



IR SWITCH 5A 230V~ 1M

- IR infrared switch
- supply voltage: 230V~ ±10 % 50Hz
- relay: 5A / 250V~ (zero crossing)
- protection rating: IP40
- cross-section of wires at the contact terminal: 0.75 - 2.5 mm²
- detection angle: up to 110° at 20°C
- detection area: approx. 8 m at 20°C
- adjustability of duration: from approx. 5 s to 12 min
- adjustability of brightness: from approx. 5 to 200 LUX
- operating temperature: from 0°C to +40°C
- not suitable for installation in 45 mm deep boxes and surface mount box CUBO IP20
- only for indoor usage

IR STIKALO 5A 230V~ 2M

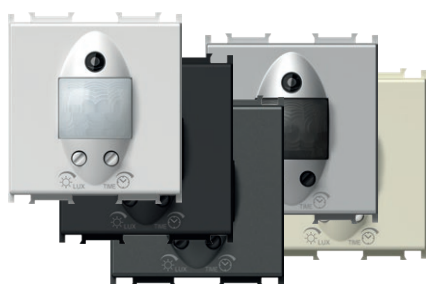

- EM32PW
- EM32MW
- EM32SB
- EM32AT
- EM32ES
- EM32IW

- IR infrardeče stikalo
- napajanje: 230V~ ±10 % 50Hz
- rele: 5A / 250V~ (zero crossing)
- stopnja varnosti: IP40
- presek žic pri stičniku: 0,75 - 2,5 mm²
- kot zaznavanja: do 110° pri 20°C
- območje zaznavanja: približno 8 m pri 20°C
- nastavljenost časovnega trajanja: od približno 5 s do 12 min
- nastavljenost osvetlitve: od približno 5 do 200 LUX
- temperatura delovanja: od 0°C do +40°C
- ni primeren za vgradnjo v doze, globine 45 mm in ohišja CUBO IP20
- samo za notranjo uporabo



IR SWITCH 5A 230V~ 2M

- IR infrared switch
- supply voltage: 230V~ ±10 % 50Hz
- relay: 5A / 250V~ (zero crossing)
- protection rating: IP40
- cross-section of wires at the contact terminal: 0.75 - 2.5 mm²
- detection angle: up to 110° at 20°C
- detection area: approx. 8 m at 20°C
- adjustability of duration: from approx. 5 s to 12 min
- adjustability of brightness: from approx. 5 to 200 LUX
- operating temperature: from 0°C to +40°C
- not suitable for installation in 45 mm deep boxes and surface mount box CUBO IP20
- only for indoor usage

območje zaznavanja /
detection range

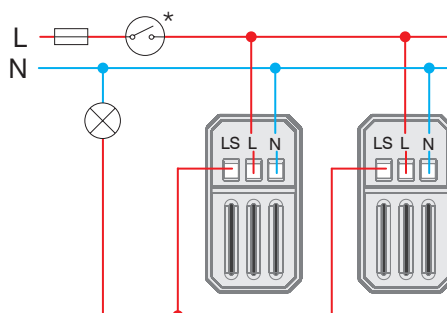
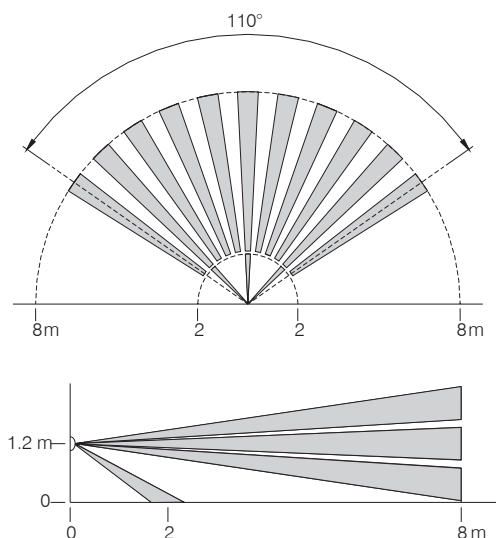

E L E C T R O N I C S E M

nastavitev občutljivosti in časa osvetlitve /
time and twilight adjustment

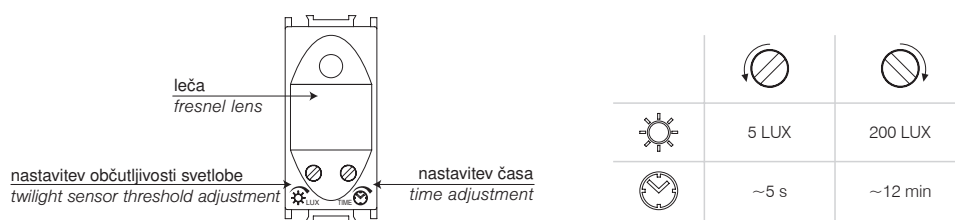

| | 1 | 2 | 3 | 4 | 5 | 6 | 7 | 8 |
|------|-------|-------|----|---------|--------|---------------|---------|---------|
| Min. | 1 W | 1 W | | 1 VA | 1 W | 1 W | 1 VA | 1 VA |
| Max. | 800 W | 800 W | 5A | 6x20 VA | 6x36 W | 4x36 W (20μF) | 6x23 VA | 6x20 VA |

1 - žarnica z žarilno nitko /
incandescent lamp

2 - halogenska žarnica /
halogen lamp

3 - uporavno grelno telo /
resistive heating element

4 - elektronski transformator /
electronic transformer

5 - fluorescentna cev (izvedba 1) /
fluorescent tube (version 1)

6 - fluorescentna cev (izvedba 2) /
fluorescent tube (version 2)

7 - varčna CFL sijalka /
energy saving CFL lamp

8 - LED sijalka /
LED lamp

opozorila /
attention

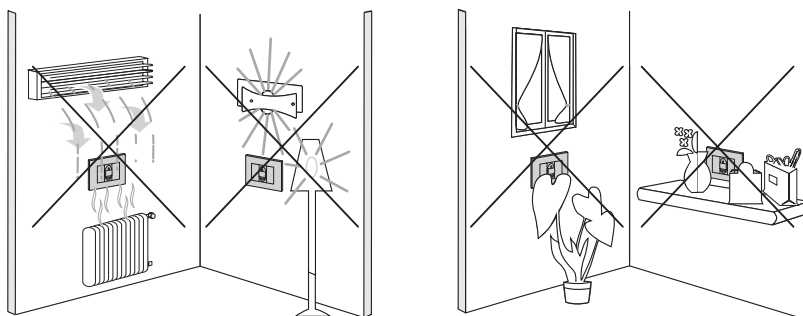

1M = 22,5 x 45
2M = 45 x 45

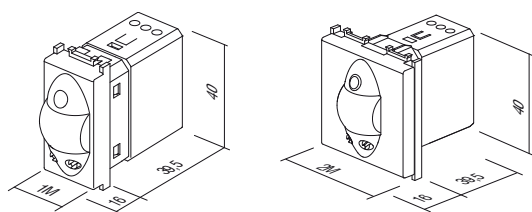

TERMOSTAT OSNOVNI 6A 230V~ 2M



- EM37PW
- EM37SB
- EM37AT
- EM37ES
- EM37IW

- termostat elektronski osnovni
- način delovanja: ogrevanje / hlajenje / izklop
- napajanje: 230 VAC, 50 Hz
- izhod: 6(2) A, 230 VAC, preklopni rele
- območje regulacije: +10 °C do +30 °C
- histereza: ±0,5 °C, ED = 20min
- zaščita proti zmrzovanju (način ogrevanje): +6 °C
- zaščita proti pregrevanju (način hlajenje): +32 °C
- funkcija ECO za znižanje temperature za 3 °C za 6 ur v načinu ogrevanje in povečanje temperature za 3 °C za 6 ur v načinu hlajenje
- funkcija adaptivni ECO, avtomatsko vsak dan ob istem času zniža temperaturo za 3 °C za 6 ur v načinu ogrevanje in poveča temperaturo za 3 °C za 6 ur v načinu hlajenje
- možnost vklopa ECO režima delovanja z zunanjim proženjem preko ločenega vhoda
- LED signalizacija delovanja
- ni primeren za električno talno ogrevanje
- vijačna pritrditev vodnikov max. 2.5 mm²
- ustreza LV Direktivi, EMC direktivi, standardi EN60730-1 in EN60730-2-9
- za pravilno delovanje, priporočamo vgradnjo v samostojno dozo, ločeno od naprav, ki generirajo toploto
- temperatura uporabe: 5 ÷ 35 °C
- temperatura skladiščenja: -20 ÷ 50 °C



Termostat je namenjen reguliranju temperature v prostoru. Termostat omogoča dva načina delovanja – ogrevanje ali hlajenje. Vgrajene ima varovalne funkcije zaščito proti zmrzovanju (način ogrevanja) in zaščito proti pregrevanju (način hlajenja). Delovanje se signalizira s pomočjo LED signalizacije. Nastavljanje termostata se vrši s pomočjo rotacijskega gumba za nastavitev temperature in kapacitivnih tipk na dotik.

The thermostat is intended for regulating temperature in a room. A thermostat enables two modes of operation – heating or cooling. It has safety functions installed for protection against freezing (heating mode) and protection against overheating (cooling mode). The operation is indicated via LED signaling. Thermostat setup is performed with the help of a rotary button for setting the temperature and with other capacitive touch buttons.

THERMOSTAT BASIC 6A 230 V ~ 2M

- electronic thermostat, basic
- operation mode: heating/cooling/turn off
- power supply: 230 VAC, 50 Hz
- output: 6(2) A, 230 VAC, relay switch
- regulation range: +10 °C to +30 °C
- hysteresis: ±0.5 °C, ED = 20min
- anti-freeze protection (heating mode): +6 °C
- overheating protection (cooling mode): +32 °C
- ECO function for lowering the temperature by 3 °C for 6 hours in the heating mode and raising temperature by 3 °C for 6 hours in the cooling mode
- adaptive ECO function, automatically every day at the same time lowers the temperature by 3 °C for 6 hours in the heating mode and raises temperature by 3 °C for 6 hours in the cooling mode
- option to turn on the ECO operating mode by external trigger via a separate input
- LED signalling of the operation
- not suitable for electrical floor heating
- screw contacts max. 2.5 mm²
- in accordance with the LV Directive, the EMC Directive, standards EN60730-1 and EN60730-2-9
- for correct operation, we recommend installing in an independent single box, separate from devices that generate heat
- operating temperature: 5 ÷ 35 °C
- storage temperature: -20 ÷ 50 °C

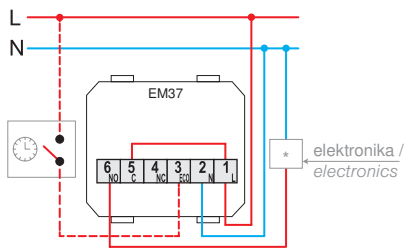

obtočna črpalka, gorilnik (direktna priključitev),
termoelektrični pogon /
circulation pump, burner (direct connection)
thermoelectric drive

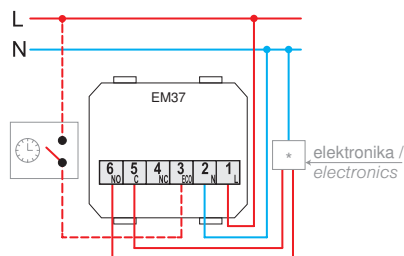

kotel, toplotna črpalka, gorilnik (krmilni vhod T1/T2) /
boiler, heat pump, burner (control input T1/T2)

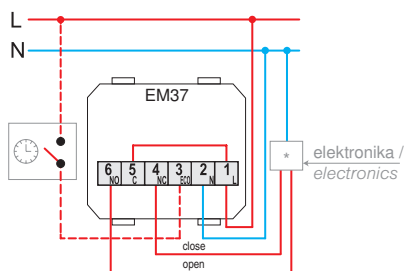

motorni pogon (omejena uporaba pri talnem ogrevanju) /
motor drive (limited use with underfloor heating)

nastavitev delovanja in temperature /
function and temperature adjustment

tipka za izbiro delovanja in
LED signalizacija stanja:
rdeča: ogrevanje
modra: hlajenje
ne sveti: izklopljeno

function selection button and
LED status signalization:
red: heating
blue: air conditioning
no light: switched off

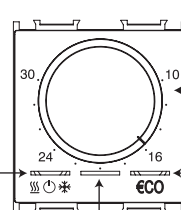

nastavitev temperature
temperature setting

tipka za izbiro "ECO" režima in
LED indikator "ECO" režima
zelen: ECO režim vklopljen
oranžna: adaptivni ECO aktiviran
ne sveti: dnevni režim

"ECO" function selection button and
LED "ECO" status indicator
green: ECO energy saving ON
orange: adaptive ECO mode activated
no light: day mode

LED signalizacija stanja izhodnega releja
bela: rele vklopljen
ne sveti: rele izklopljen

LED output relay state signalization
white: relay ON
no light: relay OFF

opozorila /
attention

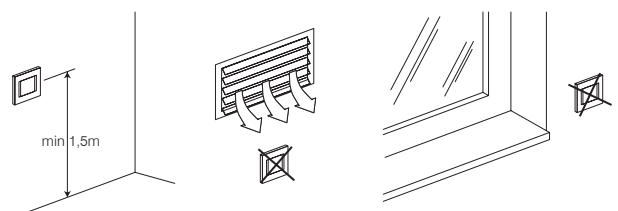

TERMOSTAT OGREVANJE 5(2)A 230V~ 2M

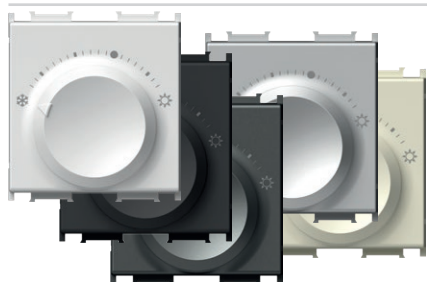

- EM38PW
- EM38MW
- EM38SB
- EM38AT
- EM38ES
- EM38IW

- način delovanja: ogrevanje
- napajanje: 230 VAC, 50 Hz
- napetostni pulz: 4 kV
- poraba energije: < 0,5 W
- izhod: 2 A (max. 5 A); 230 VAC, 50 Hz
- izhodni priključek: NO (max. 10 aktuatorjev)
- območje regulacije: +5 °C do +30 °C
- zaščita proti zmrzovanju: +5 °C
- histereza: 0,5 K
- zaščita: IP30
- vrsta tipala: bimetal
- vrsta električnega priključka: vzmetni kontakti
- vrsta vodnikov:
- 0,75 - 1,5mm² (mehkožilni);
- 1,0 - 2,5 mm² (trdožilni)
- skladno z direktivo DIN EN 60730



HEATING THERMOSTAT 5(2)A 230V~ 2M

- operation mode: heating
- power supply: 230 VAC, 50 Hz
- voltage pulse: 4 kV
- energy consumption: < 0.5 W
- output: 2 A (max. 5 A); 230 VAC, 50 Hz
- switching output: NO (max. 10 actuators)
- regulation range: +5°C to +30°C
- frost protection: +5°C
- hysteresis: 0.5 K
- protection: IP30
- sensor type: Bimetal
- type of electrical connection: Spring-loaded contacts
- type of conductors: 0.75 – 1.5 mm² (flexible-stranded core);
- 1.0 – 2.5 mm² (solid core)
- in compliance with Directive DIN EN 60730

TERMOSTAT OGREVANJE/HLAJENJE 3(1,5)A 230V~ 2M

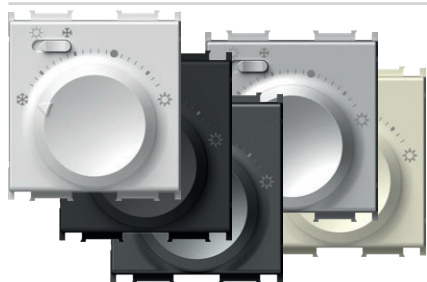

- EM39PW
- EM39MW
- EM39SB
- EM39AT
- EM39ES
- EM39IW

- način delovanja: ogrevanje/hlajenje
- napajanje: 230 VAC, 50 Hz
- napetostni pulz: 4 kV
- poraba energije: < 0,5 W
- izhod: 1.5 A (max. 3 A); 230 VAC, 50 Hz
- izhodni priključek: preklopno stikalo (max. 5 aktuatorjev)
- območje regulacije: +5 °C do +30 °C
- zaščita proti zmrzovanju: +5 °C
- histereza: 0,5 K
- zaščita: IP30
- vrsta tipala: bimetal
- vrsta električnega priključka: vzmetni kontakti
- vrsta vodnikov:
- 0,75 - 1,5mm² (mehkožilni);
- 1,0 - 2,5 mm² (trdožilni)
- skladno z direktivo DIN EN 60730



HEATING/COOLING THERMOSTAT 3(1,5)A 230V~ 2M

- operation mode: cooling/heating
- power supply: 230 VAC, 50 Hz
- voltage pulse: 4 kV
- energy consumption: < 0.5 W
- output: 1 A (max. 3 A); 230 VAC, 50 Hz
- switching output: mode selector switch (max. 5 actuators)
- regulation range: +5°C to +30°C
- frost protection: +5°C
- hysteresis: 0.5 K
- protection: IP30
- sensor type: Bimetal
- type of electrical connection: Spring-loaded contacts
- type of conductors: 0.75 - 1.5mm² (flexible-stranded core);
- 1.0 - 2.5 mm² (solid core)
- in compliance with the Directive DIN EN 60730

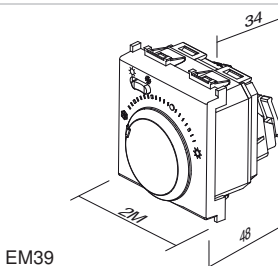
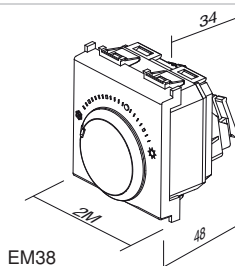
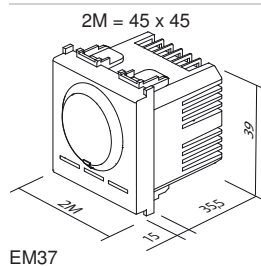
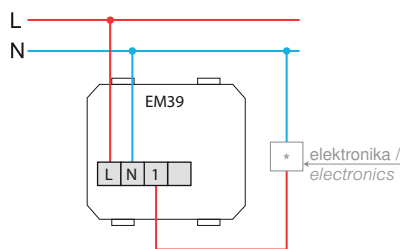
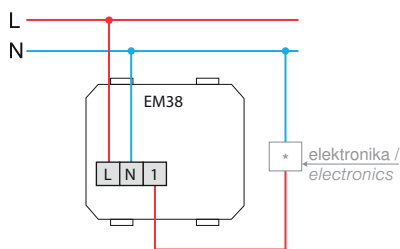

NOSILEC Z VIJAKI ZA TERMOSTATE FANTINI COSMI 3M

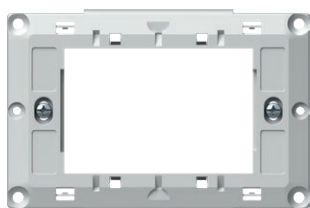

NM39

- nosilec z vijaki za termostate Fantini Cosmi 3M
- namenjen za uporabo z dnevnimi termostati Fantini Cosmi za modela CH121 in CH123
- namenjen za uporabo s tedenskimi termostati Fantini Cosmi za modela CH141A in CH143A
- montaža v pravokotne doze velikosti 3M
- primeren za sestavo z okvirji PURE, Line, Soft

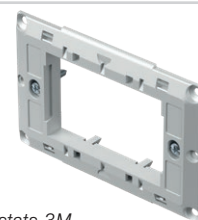

MOUNTING FRAME WITH SCREWS FOR FANTINI COSMI THERMOSTATS 3M

- mounting frame with screws for Fantini Cosmi thermostats 3M
- suitable for use with Fantini Cosmi daily thermostats models CH121 and CH123
- suitable for use with Fantini Cosmi weekly thermostats models CH141A and CH143A
- for mounting in rectangular boxes 3M
- suitable for assembling with cover plates PURE, Line, Soft

KARTIČNO STIKALO ZA VARČEVANJE Z ENERGIJO 3A 250V~ 3M



- EM40PW
- EM40MW
- EM40SB
- EM40AT
- EM40ES
- EM40IW

- kartično stikalo osnovno, poljubna ISO kartica
- napajanje 230V~ 50Hz
- izhod 3A 250V~ za vklop zunanjega kontaktorja *
- zakasnitev izklopa 15-20s
- ustreza EN 61000-6-1
- kartica ni priložena
- ni namenjeno kontroli pristopa

ENERGY SAVER CARD SWITCH 3A 250V~ 3M

- card switch basic, any ISO card
- supply voltage 230V~ 50Hz
- output 3A 250V~ for switching contactor *
- switch off delay 15-20s
- in accordance with EN 61000-6-1
- card is not included
- not for access control



3M = 67,5 x 45

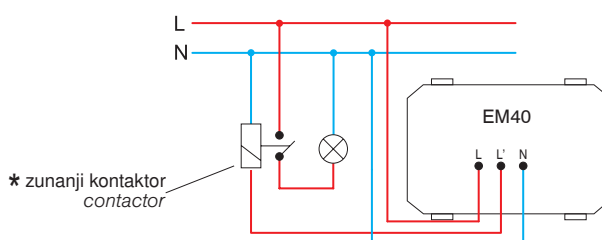
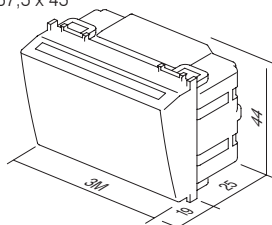

KARTICA ISO

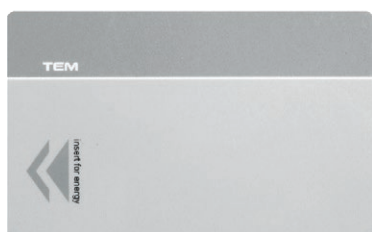

EM47

- ISO kartica
- za uporabo s kartičnim stikalom EM40
- velikost: 85x54 mm

CARD ISO

- ISO card
- for combination with card switch EM40
- size: 85x54 mm



EM44BK

KARTIČNO STIKALO ZA VARČEVANJE Z ENERGIJO RF HF 13,56MHz 3M

- kartično stikalo elektronsko na RFID ISO kartico
- napajanje iz rele enote EM49 preko kabla s konektorji RJ12
- izhod za povezavo z rele enoto EM49
- zakasnitev izklopa "main power" ob izvlečenju kartice 15-20 s
- zakasnitev izklopa "HVAC" ob izvlečenju kartice pri odprtih balkonskih vratih ali oknu - 1 min
- ustreza EN 61000-6-1
- kartica ni priložena
- ni namenjeno kontroli pristopa

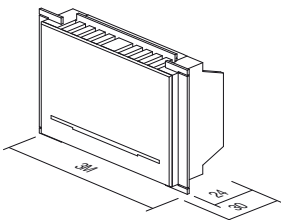
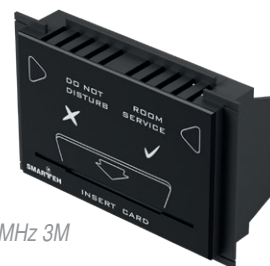

ENERGY SAVER CARD SWITCH RF HF 13,56MHz 3M

- electronic card switch for RFID ISO card
- supply from relay unit EM49 through cable connectors RJ12
- output to be connected to relay output unit EM49
- 15-20s "main power" switch off delay with card withdrawal
- 1 min "HVAC" switch off delay with card withdrawal when balcony doors or windows opened
- in accordance with EN 61000-6-1
- card is not included
- not for access control

RELE ENOTA ZA KARTIČNO STIKALO 2X16A 250V~

- rele enota za kartična stikala EM44
- napajanje 230V~ 50 Hz
- ustreza EN 61000-6-1
- montaža na DIN letev 35mm, 3MU
- vhodi in izhodi glede na vgradnjo: enosobno ali dvosobno



ENERGY SAVER CONTROL UNIT 2x16A 250V~

- relay unit for card switches EM44
- supply voltage 230V~ 50Hz
- in accordance with EN 61000-6-1
- mounting on DIN rail 35mm, 3MU
- input and output depending on implementation: single or double room

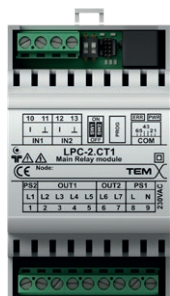

EM49

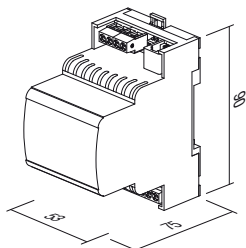

RAZDELILNIK SPL-1

- za povezavo dveh kartičnih stikal EM44 z rele enoto EM49
- komunikacijski konektor RJ12
- velikost: 37 x 30 x 27 mm



EM45

SPLITTER SPL-1

- used to connect two peripheral modules EM44 to relay unit EM49
- communication connector RJ12
- size: 37 x 30 x 27 mm

vezalna shema za enosobno delovanje / wiring diagram for single room implementation

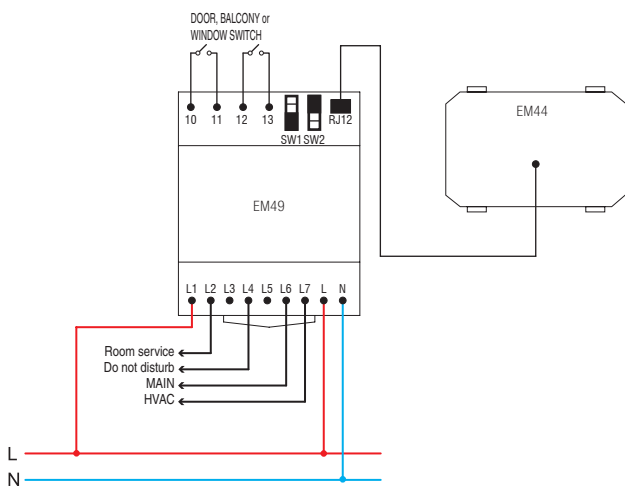

vezalna shema za dvosobno delovanje / wiring diagram for double room implementation

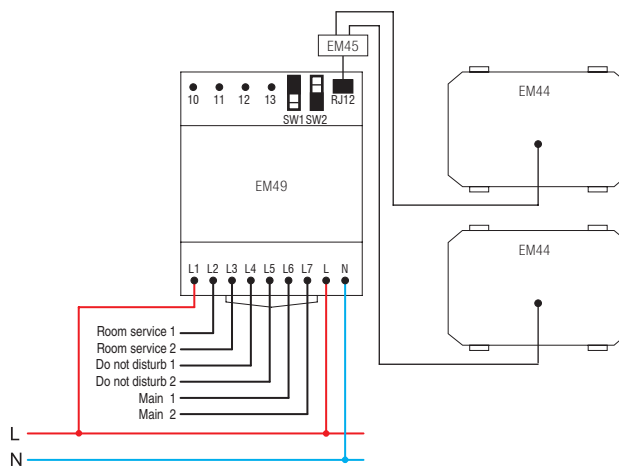

povezovalni kabel RJ12 med EM44 in EM49 / connection cable RJ12 between EM44 and EM49

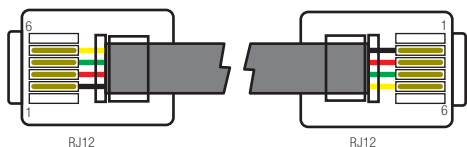

VTIČNICA ZA BRIVNIK 230V~/120V~ 3M

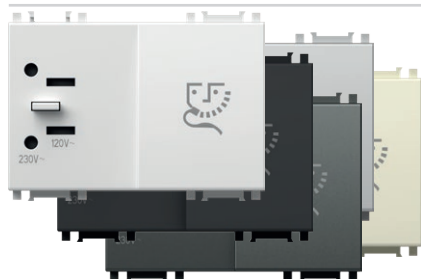

- EM60PW
- EM60MW
- EM60SB
- EM60AT
- EM60ES
- EM60IW

- vtičnica za brivnik z ločilnim transformatorjem 20VA
- vhod: 230V~ 50-60Hz
- izhod:
- 230V~ za 2P 2.5A EURO vtič ali
- 120V~ za 2P 15A ameriški vtič
- razred zaščite II
- ustreza EN 61558-2-5



SOCKET SHAVER 230V~/120V~ 3M

- shaver supply unit with isolating transformer 20VA
- supply: 230V~ 50-60Hz
- output:
- 230V~ for 2P 2.5A Europlug or
- 120V~ for 2P 15A American plug
- Class II
- in accordance with EN 61558-2-5

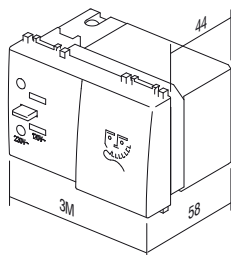

3M = 67,5 x 45

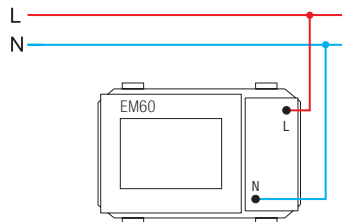

POLNILNIK USB 5V 2,4A 1M



- EM67PW
- EM67MW
- EM67SB
- EM67AT
- EM67ES
- EM67IW

- za polnjenje elektronskih naprav prek standardnega USB priključka (kompatibilno tudi z Apple napravami)
- napajanje: 100-230 V~ 50/60 Hz
- poraba med delovanjem:
- 300 mA pri 100 V~/150 mA pri 230 V~
- poraba v mirovanju: 30 mW pri 230 V~
- izhodna napetost: 5 VDC ($\pm 5\%$) SELV
- nihanje izhodne napetosti: 150 mV
- nominalni izhodni tok: 2,4 A ($\pm 10\%$)
- učinkovitost: maksimalno 77 %
- temperatura delovanja: 0 °C/+ 45 °C (notranja uporaba)
- IP zaščitni razred: IP20, samo za notranjo uporabo
- varnostni razred naprave II
- prenapetostna zaščita (EN 62109): razred III
- vijačna pritrditev vodnikov max. 2.5 mm²
- naprava z odmikom kontaktov min. 3 mm
- ustreza standardu EN 60950-1 in direktivam EMC in LVD
- ni primeren za vgradnjo v doze globine 45 mm in ohišja CUBO IP20

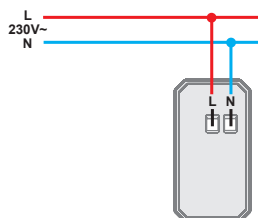
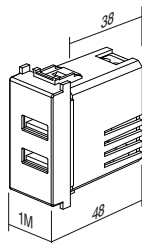

USB POWER SUPPLY UNIT 5V 2,4A 1M

- for charging of electronic devices via a standard USB port (also compatible with Apple devices)
- power supply: 100-230V~ 50/60Hz
- power consumption: 300mA at 100V~/150mA at 230V~
- standby power consumption: 30mW at 230V~
- nominal output voltage: 5 VCD ($\pm 5\%$) SELV
- output ripple voltage: 150mV
- nominal output current: 2,4A ($\pm 10\%$)
- efficiency: maximum of 77%
- operating temperature: 0°C/+45°C (indoor use)
- IP protection class: IP20, indoor use only
- class device II
- overvoltage category (EN 62109): Class III
- screw contacts: max. 2.5 mm²
- device with a contact gap of at least 3mm
- in accordance with EN 60950-1 and LVD & EMC directives
- not suitable for installation in 45 mm deep boxes and surface mount boxes CUBO IP20

POLNILNIK USB 5V 3,0A



- EM68PW
- EM68MW
- EM68SB
- EM68AT
- EM68ES
- EM68IW

- za polnjenje elektronskih naprav prek standardnega USB priključka (kompatibilno tudi z Apple napravami)
- napajanje: 100-230 V ~ 50/60 Hz
- poraba med delovanjem: 300 mA pri 100 V~/150 mA pri 230 V~
- poraba v mirovanju: 30 mW pri 230 V~
- izhodna napetost: 5 VDC ($\pm 5\%$) SELV
- nihanje izhodne napetosti: 150 mV
- nominalni izhodni tok: 3,0 A ($\pm 10\%$)
- tip konektorja: USB A / USB C
- učinkovitost: maksimalno 77 %
- temperatura delovanja: 0 °C/+ 45 °C (notranja uporaba)
- IP zaščitni razred: IP20, samo za notranjo uporabo
- varnostni razred naprave II
- prenapetostna zaščita (EN 62109): razred III
- vijajčna pritrditev vodnikov max. 2,5 mm²
- naprava z odmikom kontaktov min. 3 mm
- ustreza standardu EN 60950-1 in direktivam EMC in LVD
- ni primeren za vgradnjo v doze globine 45 mm in ohišja CUBO IP20

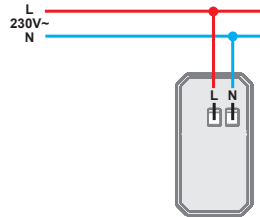
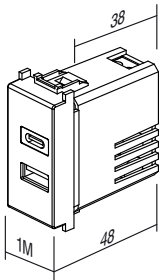

USB POWER SUPPLY UNIT 5V 3,0A

- for charging of electronic devices via a standard USB port (also compatible with Apple devices)
- power supply: 100-230V~ 50/60Hz
- power consumption: 300mA at 100V~/150mA at 230V~
- standby power consumption: 30mW at 230V~
- nominal output voltage: 5 VCD ($\pm 5\%$) SELV
- output ripple voltage: 150mV
- nominal output current: 3,0 A ($\pm 10\%$)
- connector type: USB A / USB C
- efficiency: maximum of 77%
- operating temperature: 0°C/+45°C (indoor use)
- IP protection class: IP20, indoor use only
- class device II
- overvoltage category (EN 62109): Class III
- screw contacts: max. 2.5 mm²
- device with a contact gap of at least 3mm
- in accordance with EN 60950-1 and LVD & EMC directives
- not suitable for installation in 45 mm deep boxes and surface mount boxes CUBO IP20

LED ZASILNA SVETILKA 250V~ 0.9W, NiCd 3h 7M



- EM55

- zasilna LED svetilka
- napajanje 250V~ 50Hz 3xLED 0,3W, 10000mcd, 6500K
- NiCd akumulator 4,8V 400 mAh, zamenljiv
- avtonomija 3h, polnjenje 24h
- razred zaščite II
- ustreza EN 60598-1, EN 60598-2-2, EN 60598-2-22



LED EMERGENCY LIGHT 250V~ 0.90W, NiCd 3h 7M

- emergency LED lamp
- supply voltage 250V~ 50Hz 3x LED 0,3W, 10000mcd, 6500K
- NiCd accumulator 4,8V 400 mAh, replaceable
- autonomy 3h, charging 24h
- Class II
- in accordance with EN 60598-1, EN 60598-2-2, EN 60598-2-22

7M = 157 X 45

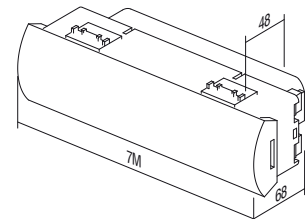
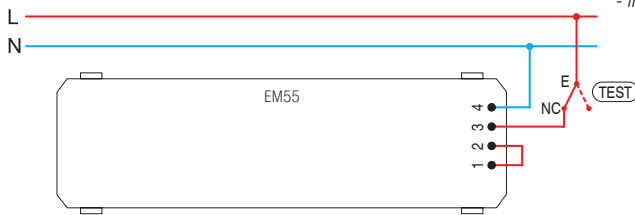

LED ZASILNA SVETILKA 230V~50Hz, 0.5W, NiMH 2h 2M



- EM57

- zasilna LED svetilka
- možnost uporabe kot prenosne ročne svetilke (izvlečni mehanizem)
- napajanje 230V 50Hz 1xLED 0.5W
- NiMH akumulator 3,6V 140mAh, zamenljiv
- avtonomija 2 h, polnjenje 36 h
- varnostni razred naprave II
- ustreza EN60598-1, EN60598-2-2, EN62471, EN55015:2006, EN61547

LED EMERGENCY LIGHT 230V~50Hz, 0.5W, NiMH 2h 2M

- emergency LED lamp
- option to use it as a hand lamp (pull-out mechanism)
- supply voltage 230V~50Hz, 1xLED 0.5W
- NiMH accumulator 140mAh, replaceable
- autonomy 2h, charging 36h
- class device II
- in accordance EN60598-1, EN60598-2-2, EN62471, EN55015:2006, EN61547

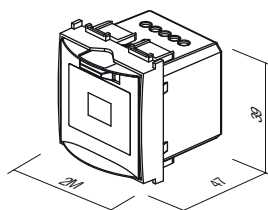
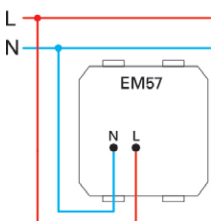
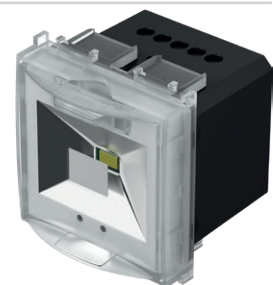

LED AMBIENTALNA ENOTA ENOBARVNA 250V~ 0,8W 2M

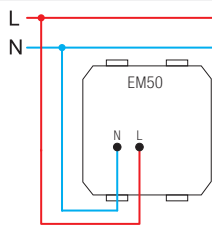

- EM50WH
- EM50BL
- EM50RD
- EM50GR

- LED ambientalna enota za stopnišča in hodnike
- napajanje 230V~ 50Hz 0,8W, 6500K
- razred zaščite II
- ustreza EN 60598-1
- uporaba tudi za usmerjanje ali signalizacijo z možnostjo laserskega tiska poljubne grafike



LED AMBIENT UNIT MONOCOLOUR 250V~ 0,8W 2M

- step marker LED unit
- supply voltage 230V~ 50Hz 0,8W, 6500K
- Class II
- in accordance with EN 60598-1
- optional usage for directional signalization with customized laser printing on diffuser

SVETILKA LED DVOBARVNA 250V~ 2x0,4W 2M

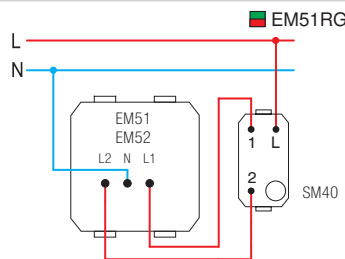

- EM51RG

- LED dvobarvna svetilka (rdeča/zelena) za signalizacijo
- napajanje 230V~ 50Hz 2x0,4W, 6500K
- razred zaščite II
- ustreza EN 60598-1
- vsebuje grafiko kot na sliki
- možnost laserskega tiska poljubne grafike

LED LAMP DUAL COLOR 250V~ 2x0,4W 2M

- signaling dual color (red/green) LED lamp
- supply voltage 230V~ 50Hz 2x0,4W, 6500K
- Class II
- in accordance with EN 60598-1
- diffuser includes graphics as shown
- possible customized laser printing on diffuser



SVETILKA LED 3D DVOBARVNA 250V~ 2x0,4W 2M

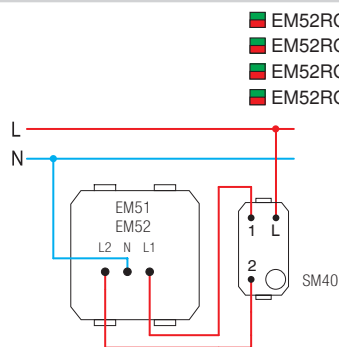

- EM52RG
- EM52RG90
- EM52RG91
- EM52RG99

- LED dvobarvna svetilka (rdeče/zelena) s 3D simbolom, za signalizacijo
- napajanje 230V~ 50Hz 2x0,4 W, 6500K
- razred zaščite II
- ustreza EN 60598-1
- možnost tiska različnih grafik po naročilu
- 90 moški simbol, 91 ženski simbol, 99 simbol po naročilu

LED LAMP 3D DUAL COLOR 250V~ 2x0,4W 2M

- signalling LED lamp, dual color (red/green) with 3D symbol
- supply voltage 230V~ 50Hz 2x0,4W, 6500K
- class II
- in accordance with EN 60598-1
- possible customized graphics on request
- 90 male symbol, 91 female symbol, 99 symbol on request



- EM52RG91

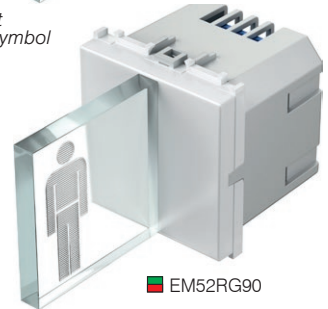

- EM52RG90

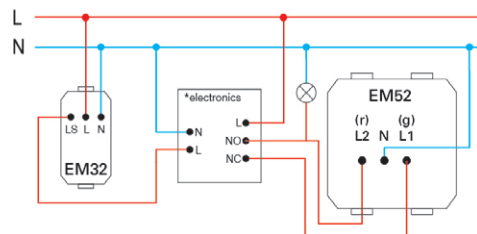

2M = 45 x 45

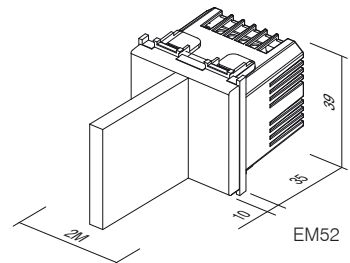
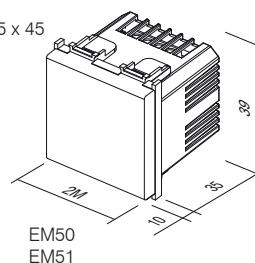



- EM71PW
- EM71MW
- EM71SB
- EM71AT
- EM71ES
- EM71IW

STIKALO NA PRSTNI ODTIS BIOPASS 2M

- stikalo na prstni odtis v kompletu z notranjo rele enoto in napajalnikom
- kapaciteta: 500 prstnih odtisov
- enostavno upravljanje prek mobilne aplikacije X-Manager
- napajalna napetost: 8-30 V – DC ali AC (napajalnik priložen)
- kapacitivni senzor
- 2 izhodna releja
- maksimalna napetost/tok na releju: 40V/3A
- čas proženja releja: 1 - 10 s
- maksimalna moč: 3,6 W
- Temperaturno območje delovanja: -30 °C do +80 °C
- Maksimalna vlažnost okolice do: 100 % IP65
- 256-bitna enkripcija povezave med stikalom in notranjo rele enoto
- Set vključuje tudi nosilec NM24 in dekorativni okvir OS20.

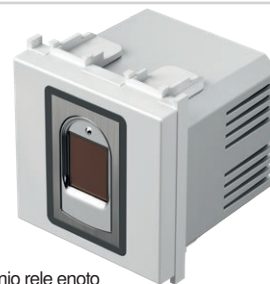

FINGERPRINT SWITCH BIOPASS 2M

- fingerprint switch with included internal relay unit and power supply
- capacity: 500 fingerprints
- easy management via X-Manager mobile app
- power supply voltage: 8-30V – DC or AC (power supply included)
- capacitive sensor
- 2 output relays
- maximum voltage/current on relay: 40V/3A
- relay triggering time: 1-10 sec
- maximum power: 3.6W
- 256-bit encrypted link between switch and internal relay unit
- Set also includes NM24 mounting frame and OS20 decorative cover plate.

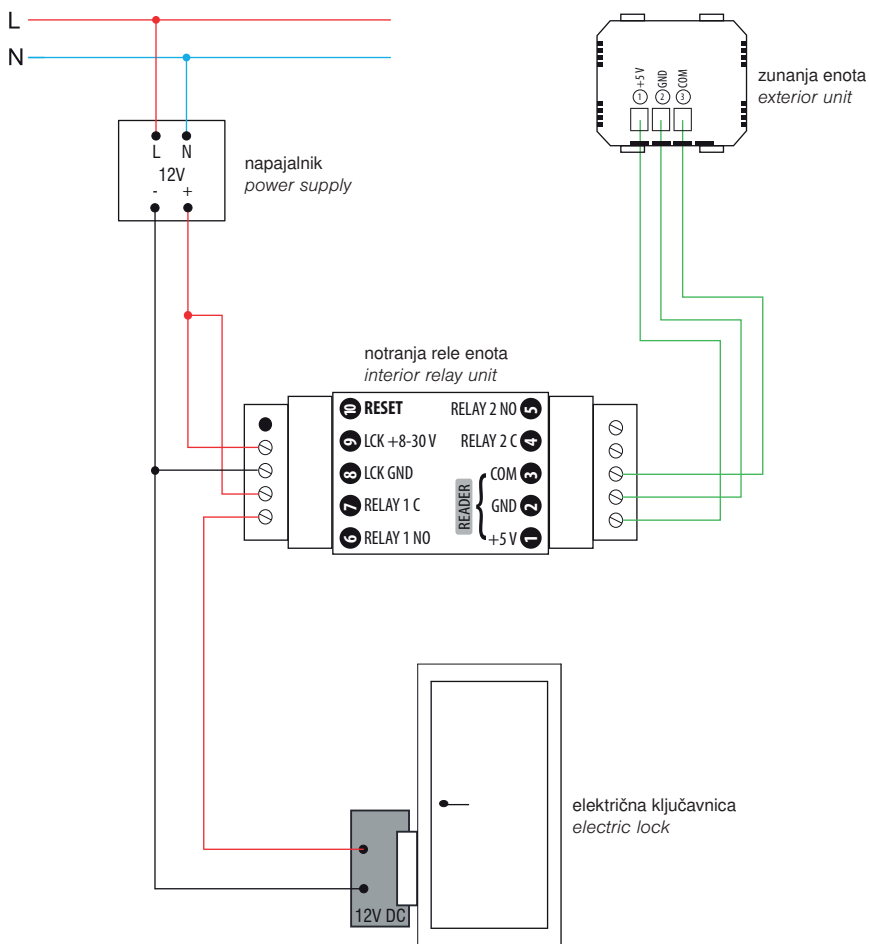

X-Manager app



podpora.tem.si



zunanja enota
exterior unit

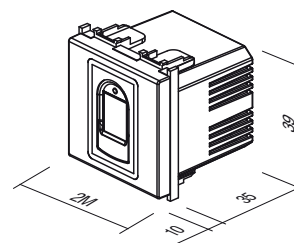

VEČOPRAVILNO ČASOVNO STIKALO EM82



- EM82PW
- EM82MW
- EM82SB
- EM82AT
- EM82ES
- EM82IW

- Napajalna napetost: 230 VAC, 50Hz
- Izhod: Rele 16 A / 250 V AC, 50Hz
- Presek žic: 0,75 – 4.0 mm²
- Temperatura delovanja: 0 do +40 °C
- Temperatura skladiščenja: -5 do +60 °C
- Funkcije: **Časovnik, Rele (krmiljeno stikalo), Stikalo, Tipkalo**
- Indikacija programa / stanja: RGB LED
- Število tipk: 2
- Vrsta delovanja tipke: Kapacitivno
- Število priključkov: 6 - 2x N, 2x L, 1x Izhod (L'), 1x Krmiljen vhod (S)
- Možnost krmiljenega vхода: Da. Priključitev signala omrežne napetosti (230 VAC) na sponko S
- Implementirano delovanje »zero crossing« (preklop stikala ob prehodu napetosti skozi 0 V)
- Poraba v stanju OFF / ON: 0.3 W / 1.0 W
- Stikalo EM82 NI PRIMERNO za vgradnjo v podometne doze globine 45 mm in ohišja CUBO IP20.
- Stikalo je namenjeno za uporabo v notranjih prostorih, zaščiteneh pred vplivom vlage.

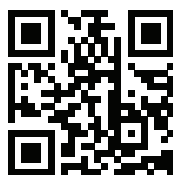
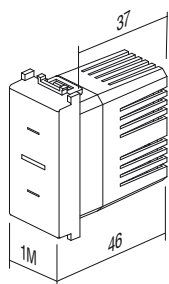

MULTIPURPOSE TIMER SWITCH EM82

- Supply voltage: 230 VAC, 50Hz
- Output: Rele 16 A / 250 V AC, 50Hz
- Wire cross section: 0,75 – 4.0 mm²
- Operating temperature: 0 to + 40 °C
- Storage temperature: -5 to + 60 °C
- Functions: **Timer, Relay (controlled switch), Switch, Push button**
- Program/status indication: RGB LED
- Number of buttons: 2
- Push button operation type: Capacitive
- Number of ports: 6 - 2x N, 2x L, 1x Output (L'), 1x Controlled input (S)
- Controlled input option: Yes. Connection of the main voltage signal (230 VAC) to terminal S.
- Implemented "zero crossing" operation (switching the switch when the voltage passes through 0 V)
- Power consumption in the OFF / ON state: 0.3 W / 1.0 W
- The EM82 switch is NOT SUITABLE for installation in concealed boxes with a depth of 45 mm and CUBO IP20 housing.
- The switch is intended for indoor use, protected from moisture.



- 1 - TIPKA 1
- 2 - LED INDIKATOR
- 3 - TIPKA 2

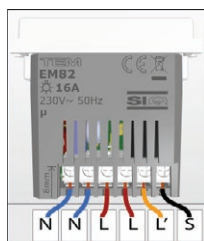

- N NEVTRALNI VODNIK
- L FAZNI VODNIK
- L' IZHOD (KRMILJENA FAZA)
- S VHODNI KRMILNI SIGNAL (230 VAC)

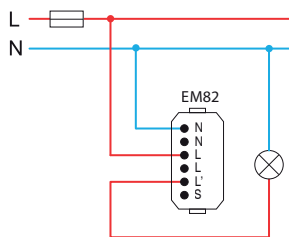

EM82 IS IN A SWITCH OR A TIMER MODE

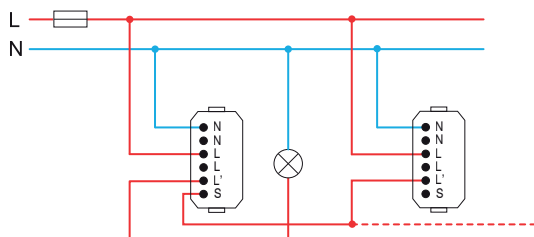

EM82-1 IS IN A SWITCH OR A TIMER MODE
EM82-2 IS IN A PUSH BUTTON MODE

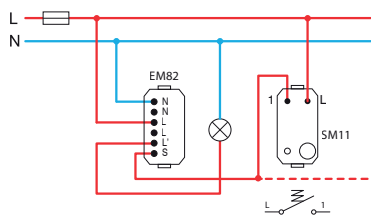

EM82 IS IN A SWITCH OR A TIMER MODE

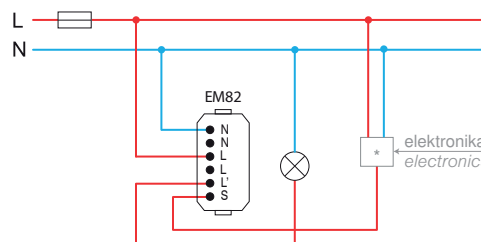

EM82 IS IN A RELAY MODE

| | 1 | 2 | 3 | 4 | 5 | 6 | 7 | 8 |
|------|------|------|------|-----|------|-----------------|--------|--------|
| | | | | | | | | |
| Max. | 16 A | 16 A | 16 A | 8 A | 8 A5 | A cos fi=0.6 | 200 VA | 200 VA |

1 - incandescent lamp
2 - halogen lamp

3 - resistive heating element
4 - electronic transformer

5 - classical transformer
6 - motor

7 - energy saving CFL lamp
8 - LED lamp

OPERATION OF THE CONTROL SIGNAL S – MODE 1

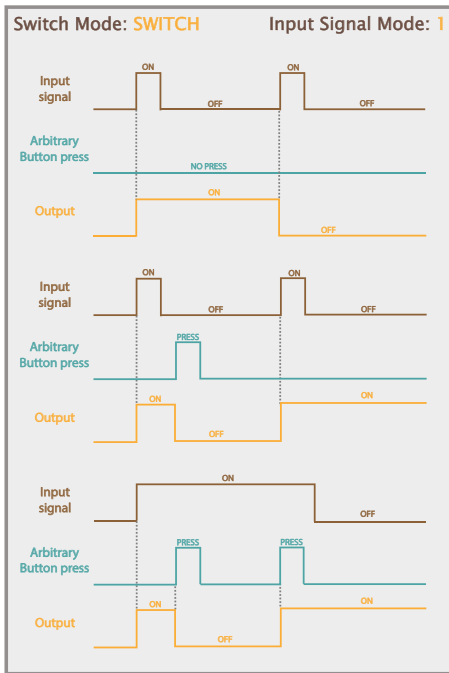

FIGURE 6: DISPLAY OF THE OPERATION OF THE EXTERNAL SIGNAL S AND BUTTONS IN THE SWITCH OPERATING MODE AND EXTERNAL SIGNAL IN MODE 1

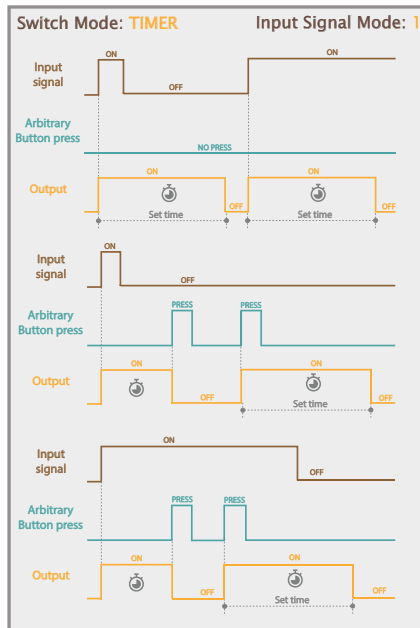

FIGURE 7: DISPLAY OF THE OPERATION OF THE EXTERNAL SIGNAL S AND BUTTONS IN THE TIMER OPERATING MODE AND EXTERNAL SIGNAL IN MODE 1

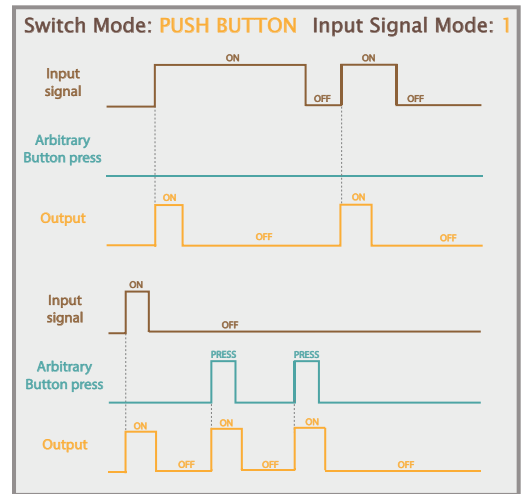

FIGURE 8: DISPLAY OF THE OPERATION OF THE EXTERNAL SIGNAL S AND BUTTONS IN THE PUSH BUTTON OPERATING MODE AND EXTERNAL SIGNAL IN MODE 1

OPERATION OF THE CONTROL SIGNAL S – MODE 2

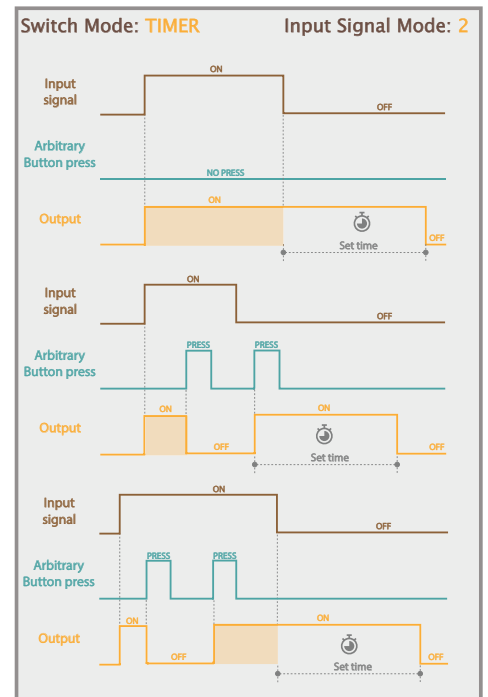

FIGURE 10: DISPLAY OF THE OPERATION OF THE EXTERNAL SIGNAL S AND BUTTONS IN THE TIMER OPERATING MODE AND EXTERNAL SIGNAL IN MODE 2

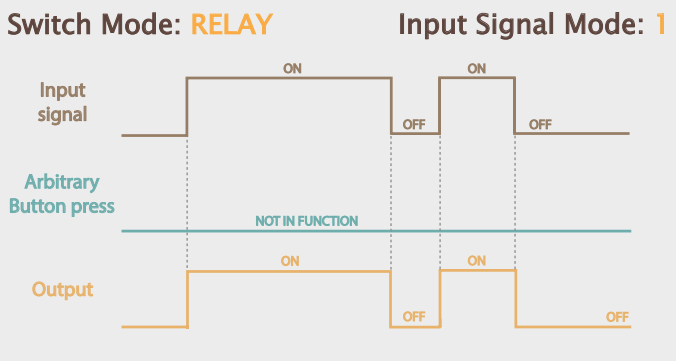

FIGURE 9: DISPLAY OF THE OPERATION OF THE EXTERNAL SIGNAL S AND BUTTONS IN THE RELAY OPERATING MODE AND EXTERNAL SIGNAL IN MODE 1

OPERATING MODE SETTINGS OF THE EXTERNAL CONTROL SIGNAL S

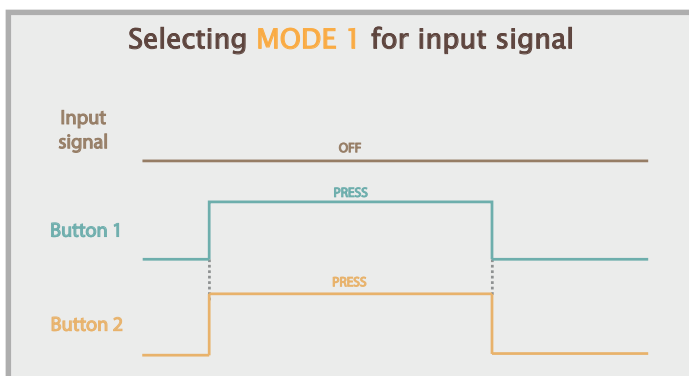

FIGURE 11: SETTING THE OPERATING MODE OF THE INPUT SIGNAL S FOR MODE 1

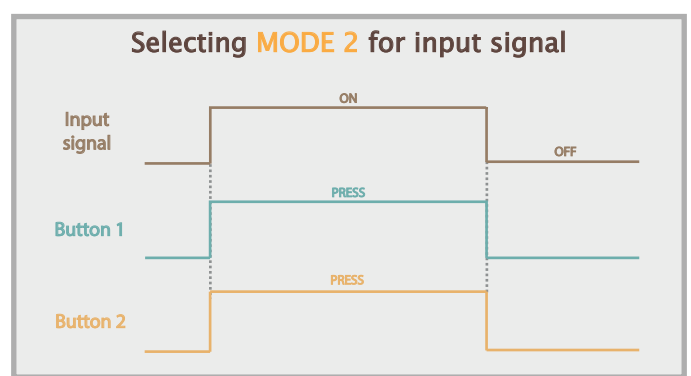
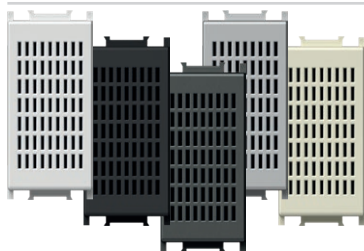

FIGURE 12: SETTING THE OPERATING MODE OF THE INPUT SIGNAL S FOR MODE 2

BRENČAČ 8VA 230V~ 1M



- EM90PW
- EM90MW
- EM90SB
- EM90AT
- EM90ES
- EM90IW

- signalni brenčač
 - dolžina zvoka je enaka dolžini pritiska na tipko
 - napajanje 230V~ 50Hz 8VA

BUZZER 8VA 230V~1M

- signal buzzer
 - the sound emission has the same lasting time as the control operation
 - supply voltage 230V~ 50Hz 8VA



BRENČAČ 8VA 12V~ 1M

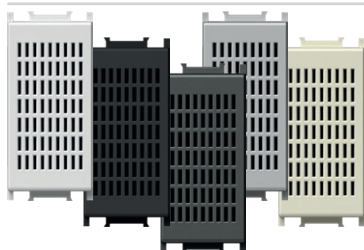

- EM91PW
- EM91MW
- EM91SB
- EM91AT
- EM91ES
- EM91IW

- signalni brenčač
 - dolžina zvoka je enaka dolžini pritiska na tipko
 - napajanje 12V~ 50Hz 8VA

BUZZER 8VA 12V~1M

- signal buzzer
 - the sound emission has the same lasting time as the control operation
 - supply voltage 12V~ 50Hz 8VA



ZVONEC 8VA 230V~ 1M

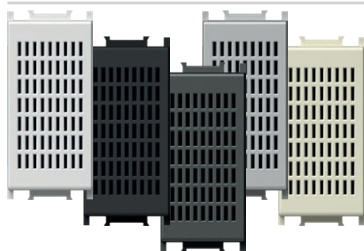

- EM92PW
- EM92MW
- EM92SB
- EM92AT
- EM92ES
- EM92IW

- signalni zvonec
 - dolžina zvoka je enaka dolžini pritiska na tipko
 - napajanje 230V~ 50Hz 8VA

BELL 8VA 230V~1M

- signal bell
 - the sound emission has the same lasting time as the control operation
 - supply voltage 230V~ 50Hz 8VA



ZVONEC 8VA 12V~ 1M

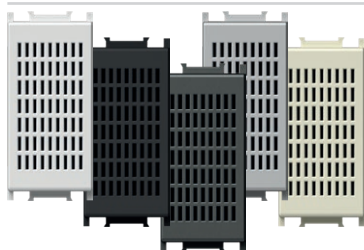

- EM93PW
- EM93MW
- EM93SB
- EM93AT
- EM93ES
- EM93IW

- signalni zvonec
 - dolžina zvoka je enaka dolžini pritiska na tipko
 - napajanje 12V~ 50Hz 8VA

BELL 8VA 12V~1M

- signal bell
 - the sound emission has the same lasting time as the control operation
 - supply voltage 12V~ 50Hz 8VA

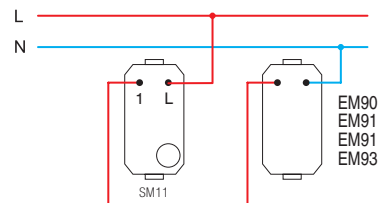
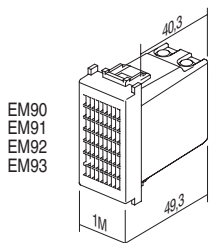

ELEKTRONSKI ZVONEC 230V~ 6mA rms 1M

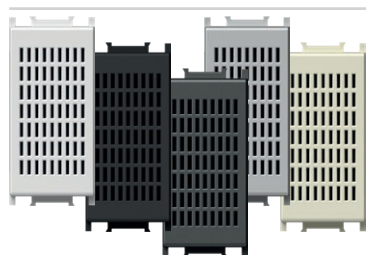

- EM94PW
- EM94MW
- EM94SB
- EM94AT
- EM94ES
- EM94IW

- napajanje 230 V~ 50/60 Hz
- poraba melodija 1; 4,7 mA rms
- poraba melodija 2; 5,9 mA rms
- nivo zvoka melodija 1; 90,5 dB
- nivo zvoka melodija 2; 86 dB
- temperatura delovanja: 0°C/45 °C (notranja uporaba)
- temperatura skladiščenja -20 °C /50 °C
- IP zaščitni razred : IP20 (samo za notranjo uporabo)
- varnostni razred naprave II
- prenapetostna zaščita (EN62109): razred III
- vijčna pritrditev vodnikov max. 2,5 mm²
- naprava z odmikom kontaktov min. 3mm
- zvonček mora biti varovan z ustreznim zunanjim odklopnikom
- direktivi EMC in LVD

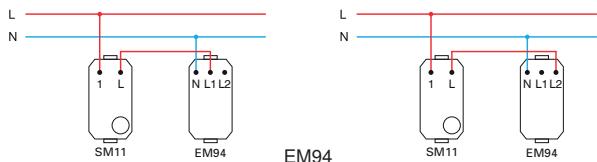

EM94

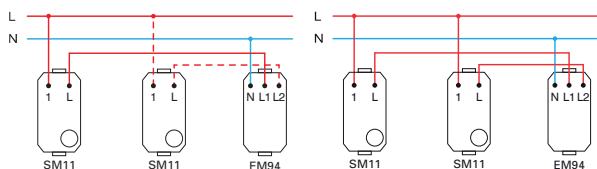

ELECTRONIC BELL 230V~ 6mA rms 1M

- power supply 230 V~ 50/60 Hz
- power consumption when playing melody 1: 4.7 mA rms
- power consumption when playing melody 2: 5.9 mA rms
- sound level of melody 1: 90.5 dB
- sound level of melody 2: 86 dB
- operating temperature 0°C/45°C (indoor use)
- storage temperature: -20°C /50°C
- IP protection class: IP20 (indoor use only)
- class device II
- overvoltage category (EN62109): Class III
- screw contacts: max. 2.5 mm²
- device with a contact gap of at least 3 mm
- an easily accessible cut-off switch must be installed upstream from bell
- complies with EMC & LVD directives

REGULATOR GLASNOSTI ZA 100V AVDIO LINIJO 35W 2M



- EM95PW
- EM95MW
- EM95SB
- EM95AT
- EM95ES
- EM95IW

- regulator glasnosti (atenuator) za 100V avdio sisteme
- nazivna moč 35W (max. 45W), 6 stopenjska nastavitev glasnosti
- primeren za vgradnjo v globoke doze (min. 60 mm)
- ni primeren za vgradnjo v doze globine 45 mm in ohišja CUBO IP20
- samo za notranjo uporabo



VOLUME CONTROL 100V AUDIO LINE 35W 2M

- volume control (attenuator) for 100V audio systems
- power rating 35W (max.45W), 6 steps volume control
- suitable for boxes min. 60 mm deep
- not suitable for installation in 45 mm deep boxes and surface mount boxes CUBO IP20
- for indoor use only

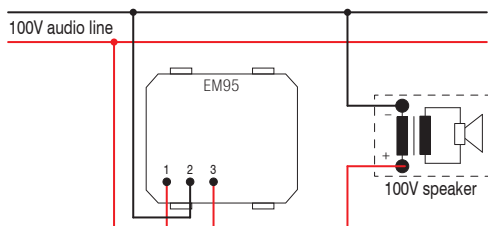

REGULATOR GLASNOSTI NIZKOOHMSKI 4-8 Ω 35W 2M

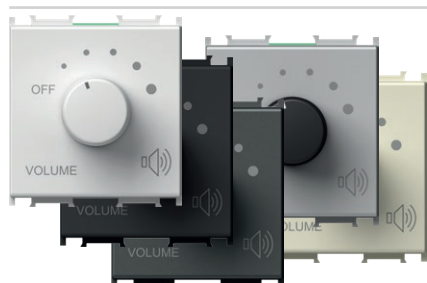

- EM96PW
- EM96MW
- EM96SB
- EM96AT
- EM96ES
- EM96IW

- regulator glasnosti za nizkonapetostne izhode 4-8 Ω 35W
- za priklop na HI-FI naprave
- nazivna moč 35W, 6 stopenjska nastavitev glasnosti
- primeren za vgradnjo v globoke doze (min. 60 mm)
- ni primeren za vgradnjo v doze globine 45 mm in ohišja CUBO IP20
- samo za notranjo uporabo



VOLUME CONTROL 4-8 Ω 35W 2M

- volume control (attenuator) for low voltage outputs 4-8 Ω, 35W
- power rating 35W, 6 steps volume control
- suitable for boxes min. 60 mm deep
- not suitable for installation in 45 mm deep boxes and surface mount boxes CUBO IP20
- for indoor use only

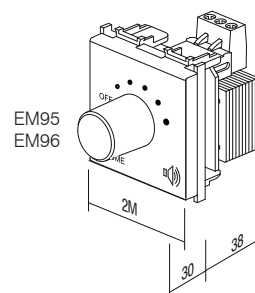
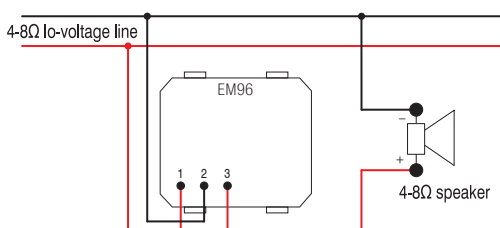

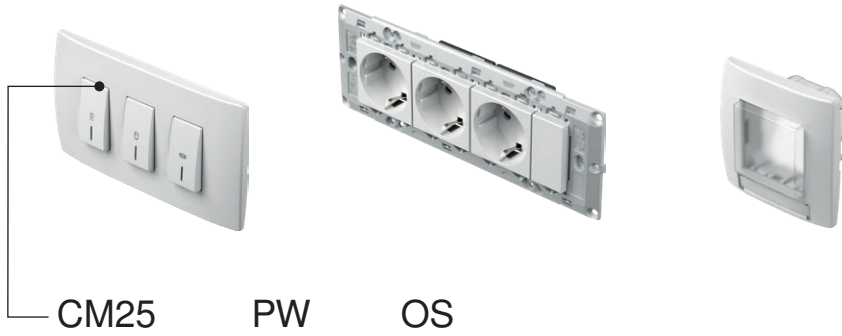

| tip type | naziv description | tehnični opis technical data | velikost size | barva colour | opsijski opis 1 optional data 1 |
|-------------|---|---------------------------------|------------------|---|--|
| CM10 | SET VTIČNIC 2x SCHUKO SOCKET SET 2x SCHUKO | 2P+E 16A 250V~ | 4M | <input type="checkbox"/> PW bela-sijaj polar white | <input type="checkbox"/> OL okvir LINE cover plate LINE |
| CM11 | SET VTIČNIC 3x SCHUKO SOCKET SET 3x SCHUKO | 2P+E 16A 250V~ | 7M | <input type="checkbox"/> MW bela- mat matte white | <input type="checkbox"/> OS okvir SOFT cover plate SOFT |
| CM15 | SET VEZNIKOV BARVNI LINK WIRE SET | 3x1.5mm ² | 1M | <input checked="" type="checkbox"/> SB črna-mat soft touch black | |
| ⋮ | ⋮ | ⋮ | ⋮ | <input checked="" type="checkbox"/> AT antracit anthracite | |
| ⋮ | ⋮ | ⋮ | ⋮ | <input type="checkbox"/> ES srebrna-mat elox silver | |
| ⋮ | ⋮ | ⋮ | ⋮ | <input type="checkbox"/> IW bež-sijaj ivory white | |

SET VTIČNIC 2x SCHUKO 2P+E 16A 250V~ 4M

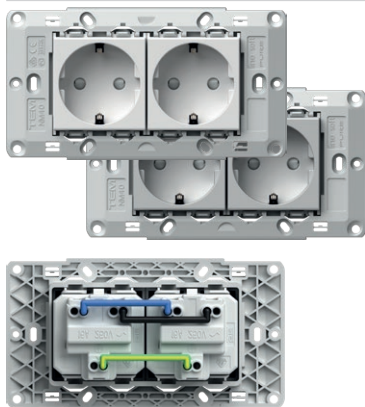

- CM10PW
- CM10ES

- set vtičnic 2x schuko VM10 2P+E 16A 250V~
- vtičnici povezani z vezniki CM16
- z nosilcem 4M brez vijakov
- za pritrnitev nosilcev uporabiti vijake CM17, CM18 ali CM19
- vijačna pritrnitev vodnikov 1.5-2.5 mm²
- ustreza IEC 60884-1, CEE7

SOCKETS SET 2x SCHUKO 2P+E 16A 250V~ 4M

- socket set 2x schuko VM10 2P+E 16A 250V~
- prewired with link wires CM16
- with mounting frame 4M without screws
- for mounting frame fixing use screws CM17, CM18 or CM19
- screw contacts 1.5-2.5 mm²
- in accordance with IEC-60884-1, CEE7

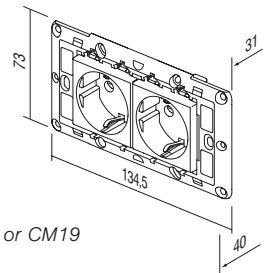

SET VTIČNIC 3x SCHUKO 2P+E 16A 250V~ 7M

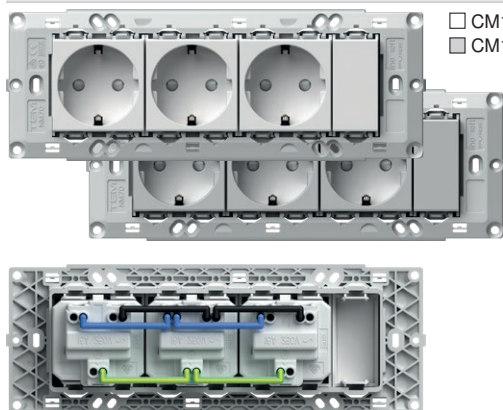

- CM11PW
- CM11ES

- set vtičnic 3x schuko VM10 2P+E 16A 250V~
- vtičnice povezane z vezniki CM16
- z nosilcem 7M brez vijakov
- za pritrnitev nosilcev uporabiti vijake CM17, CM18 ali CM19
- vijačna pritrnitev vodnikov 1.5-2.5 mm²
- ustreza IEC 60884-1, CEE7

SOCKETS SET 3x SCHUKO 2P+E 16A 250V~ 7M

- socket set 3x schuko VM10 2P+E 16A 250V~
- prewired with link wires CM16
- with mounting frame 7M without screws
- for mounting frame fixing use screws CM17, CM18 or CM19
- screw contacts 1.5-2.5 mm²
- in accordance with IEC-60884-1, CEE7

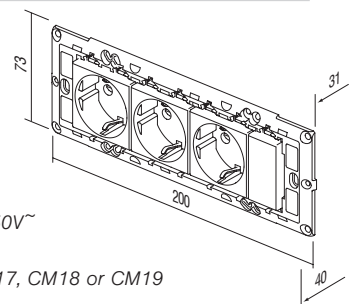

SET VEZNIKOV BARVNI 3x1.5mm² 1M

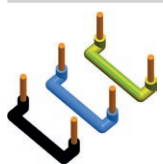

CM15

- set veznikov za povezavo dveh elementov velikosti 1M
- vsebuje 10 črnih, 10 modrih in 10 rumeno-zelenih veznikov

LINK WIRE SET 3x1.5mm² 1M

- link wire set to connect two elements size 1M
- includes 10 black, 10 blue and 10 yellow/green wires

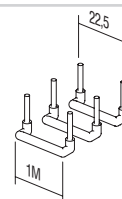

SET VEZNIKOV BARVNI 3x2.5mm² 2M

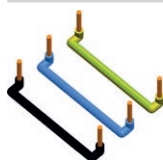

CM16

- set veznikov za povezavo dveh elementov velikosti 2M
- vsebuje 10 črnih, 10 modrih in 10 rumeno-zelenih veznikov

LINK WIRE SET 3x2.5mm² 2M

- link wire set to connect two elements size 2M
- includes 10 black, 10 blue and 10 yellow/green wires

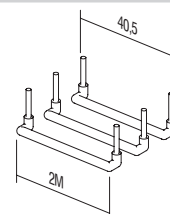

SET VIJAKOV 3,5

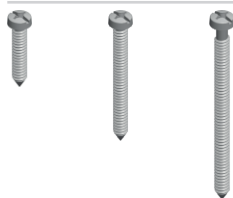

CM17
CM18
CM19

- set vijakov za pritrditev nosilcev setov NM30, NM32, NM40, NM41, NM70
- CM17 - l=20mm, 100kos
- CM18 - l=35mm, 50kos
- CM19 - l=50mm, 50kos

SCREW SET 3,5

- screw set for fixing mounting frames NM30, NM32, NM40, NM41, NM70
- CM17 - l=20mm, 100pcs
- CM18 - l=35mm, 50pcs
- CM19 - l=50mm, 50pcs

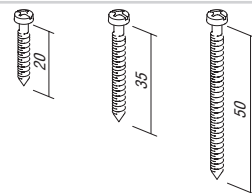

SET ZA STIKALA IP44 2M



- CM22PW
- CM22MW
- CM22SB
- CM22AT
- CM22ES
- CM22IW

- za vgradnjo v vlažne prostore
- IP44 zaščito zagotavlja za vsa stikala Modul
- stikala in tipke niso sestavni del seta
- okvir SOFT 2M z napisno ploščico
- ustreza IEC 60669-1

SET SWITCHES IP44 2M

- for usage in humid areas
- IP44 protection provides for all Modul switches
- switches and buttons are not part of the set
- SOFT 2M cover plate with inscription plate
- in accordance with IEC 60669-1



SET ZA VTIČNICE IP44 2M



- CM23PW
- CM23MW
- CM23SB
- CM23AT
- CM23ES
- CM23IW

- za vgradnjo v vlažne prostore
- IP44 zaščito zagotavlja le v kombinaciji z vtičnico s pokrovom (VM11, VM41)
- vtičnice niso sestavni del seta
- okvir SOFT 2M z napisno ploščico
- ustreza IEC 60884-1

SET SOCKETS IP44 2M

- for usage in humid areas
- IP44 protection can be achieved only in combination with covered socket (VM11, VM41)
- sockets are not part of the set
- SOFT 2M cover plate with inscription plate
- in accordance with IEC 60884-1



KOPALNIŠKI SET 3x20A 250V~ 4M

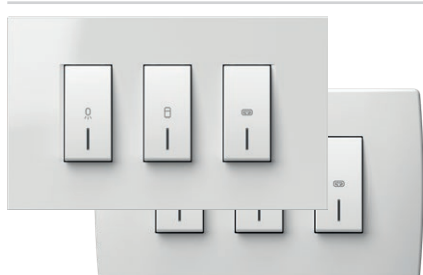

- CM25PWOL
- CM25IWOL
- CM25PWOS
- CM25IWOS

- set stikal 3xSM12 20A 250V~ z nosilcem in okvirjem
- vijalna pritrditev vodnikov 1.5-2.5mm²
- ustreza EN 60669-1
- možnost pritrditve na že vgrajene doze pritrditvenih mer od 108 do 135mm ali na doze velikosti 4M
- višina okvirja 90mm

SWITCH SET FOR BATHROOM 3x20A 250V~ 4M

- switch set 3xSM12 20A 250V~ with mounting frame and cover plate
- screw contacts 1.5-2.5mm²
- in accordance with EN 60669-1
- universal solution for renovation on boxes with fixing dimensions 108-135mm or boxes 4M size
- cover plate height 90mm

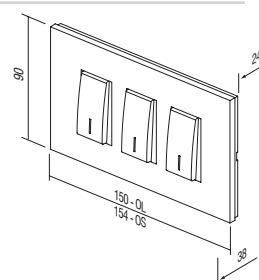

NOSILEC KOPALNIŠKI SET 4M



NM41

- nosilec kopalniški set univerzalni z vijaki
- možnost pritrditve na že vgrajene pravokotne doze pritrditvenih mer od 108 do 135mm ali na doze velikosti 4M
- ustreza EN 60669-1

MOUNTING FRAME BATHROOM SET 4M

- universal mounting frame for bathroom set with screws
- universal solution for mounting on rectangular boxes with fixing dimensions 108-135mm or boxes 4M size
- in accordance with EN 60669-1

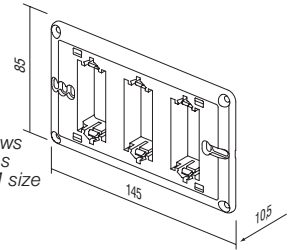

OKVIR LINE KOPALNIŠKI SET



- | | |
|--|--------|
| | OL41PW |
| | OL41MW |
| | OL41NB |
| | OL41IW |
| | OL41ES |
| | OL41SG |
| | OL41IB |
| | OL41AT |
| | OL41TI |
| | OL41SB |

- dekorativni okvir kopalniški set LINE
- višina 90mm
- ustreza EN 60669-1

COVER PLATE LINE BATHROOM SET

- decorative cover plate bathroom set LINE
- height 90mm
- in accordance with EN 60669-1

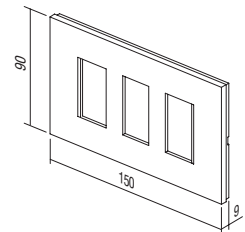

OKVIR SOFT KOPALNIŠKI SET



- | | | | |
|--|--------|--|--------|
| | OS41PW | | OS41SB |
| | OS41MW | | OS41WE |
| | OS41NB | | OS41AT |
| | OS41IW | | OS41TI |
| | OS41ES | | |
| | OS41SG | | |

- dekorativni okvir kopalniški set SOFT
- višina 90mm
- ustreza EN 60669-1

COVER PLATE SOFT BATHROOM SET

- decorative cover plate bathroom set SOFT
- height 90mm
- in accordance with EN 60669-1

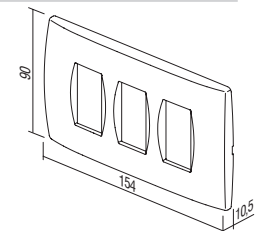

ANTIBAKTERIJSKI PROGRAM MODUL

| tip type | naziv description | velikost size | barva colour | opcijski opis 1 optional data 1 |
|----------|-------------------|---------------|--|---------------------------------|
| TM11 | TIPKA BUTTON | 1M | <input type="checkbox"/> AW antibakterijsko bela antibacterial white | NT nevtral neutral |
| TM21 | POLNILO BLANK | 1M | | |
| VM10 | VTIČNICA SOCKET | 2M | | IN indikator indicator |
| . | . | . | | |
| . | . | . | | |

ANTIBAKTERIJSKI PROGRAM MODUL

- stikala in vtičnice so vsakodnevno izpostavljene dotiku večjega števila ljudi, zato so to pogosta mesta za razvoj in širjenje bakterij
- zahvaljujoč svojim naravnim antibakterijskim lastnostim je srebro že 3 tisočletja v uporabi kot varno in učinkovito dezinfekcijsko sredstvo, saj je popolnoma naravno ter zdravju in okolju prijazno
- poseben antibakterijski dodatek srebrnih ionov zagotavlja dolgoročno, zanesljivo in učinkovito zaščito pred razvojem in širjenjem različnih bakterij, mikrobov in glivic
- antibakterijska zaščita pomeni večjo higiensko, čistočo in zdravje ljudi
- antibakterijski program MODUL je primeren za uporabo povsod, kjer veljajo strogi higienski pogoji (bolnišnice, zdravstveni domovi, farmacevtski objekti, domovi za starejše, negovalni domovi, laboratoriji, restavracije, hoteli, letališča, avtobusne in železniške postaje, poslovni in trgovski prostori, javne institucije ...)
- laboratorijska testiranja so bila opravljena v neodvisni instituciji na podlagi najvišjih japonskih standardov JIS Z 2801
- nizki stroški za zagotavljanje zdravja ljudi
- oblika in funkcionalnost antibakterijskega programa MODUL omogočata enostavno čiščenje in vzdrževanje
- antibakterijski program MODUL kombiniramo z antibakterijskimi tipkami, okvirji in vtičnicami skupaj s klasičnimi nosilci in stikali
- vsak izdelek je zaradi lažje identifikacije na zadnji strani označen z AW (antibacterial white)

ANTIBACTERIAL PROGRAM MODUL

- switches and sockets are daily touched by many people, so this is a common place for development and spread of bacteria
- thanks to its natural antibacterial characteristics silver has been used for three millennia as a safe and effective disinfectant, since it is completely natural, healthy and environmentally friendly
- special antibacterial silver ions additive provides long-term, reliable and effective protection against the development and spread of bacteria, microbes and fungi
- antibacterial protection ensures hygiene, cleanliness and health for people
- perfectly suitable for use in environments with strict hygiene conditions (hospitals, health centers, pharmaceutical facilities, homes for elderly, nursing homes, laboratories, restaurants, hotels, airports, bus and railway stations, business and shopping areas, public institutions ...)
- independent laboratory testings have been carried out in accordance with highest Japanese standards JIS Z 2801
- low cost for providing human health
- design and functionality of antibacterial program MODUL allow easy cleaning and maintenance
- antibacterial buttons, cover plates and sockets are combined with classic mounting frames and switches
- products are labelled on the back with AW (antibacterial white)

A N T I B A C T E R I A L P R O G R A M M O D U L

| | | | |
|--|-----------------------------------|---|--|
| | <input type="checkbox"/> TM11AW | <p>TIPKA 1M</p> <ul style="list-style-type: none"> - zamenljiva tipka velikosti 1M - ustreza EN 60669-1 - antibakterijska zaščita skladna z JIS Z 2801 | |
| | <input type="checkbox"/> TM11AWIN | <p>TIPKA 1M INDIKATOR</p> <ul style="list-style-type: none"> - zamenljiva tipka velikosti 1M - ustreza EN 60669-1 - antibakterijska zaščita skladna z JIS Z 2801 <p><i>BUTTON 1M</i></p> <ul style="list-style-type: none"> - replaceable button 1M - in accordance with EN 60669-1 - antibacterial protection in accordance with JIS Z 2801 | |
| | <input type="checkbox"/> TM12AW | <p>TIPKA 2M</p> <ul style="list-style-type: none"> - zamenljiva tipka velikost 2M z nosilcem tipke - uporablja se pri nadgradnji stikala ali tipkala velikosti 1M v velikost 2M - ustreza EN 60669-1 - antibakterijska zaščita skladna z JIS Z 2801 <p><i>BUTTON 2M</i></p> <ul style="list-style-type: none"> - replaceable button 2M with button carrier - to upgrade switch or push button from size 1M to size 2M - in accordance with EN 60669-1 - antibacterial protection in accordance with JIS Z 2801 | |
| | <input type="checkbox"/> TM12AWIN | <p>TIPKA 2M INDIKATOR</p> <ul style="list-style-type: none"> - zamenljiva tipka velikost 2M z nosilcem tipke - uporablja se pri nadgradnji stikala ali tipkala velikosti 1M v velikost 2M - ustreza EN 60669-1 - antibakterijska zaščita skladna z JIS Z 2801 <p><i>BUTTON 2M INDIKATOR</i></p> <ul style="list-style-type: none"> - replaceable button 2M with button carrier - to upgrade switch or push button from size 1M to size 2M - in accordance with EN 60669-1 - antibacterial protection in accordance with JIS Z 2801 | |
| | <input type="checkbox"/> TM21AW | <p>POLNILO 1M</p> <ul style="list-style-type: none"> - za zapolnjevanje praznih mest - ustreza EN 60669-1 - antibakterijska zaščita skladna z JIS Z 2801 <p><i>BLANK 1M</i></p> <ul style="list-style-type: none"> - blank modul to fill up empty spaces - in accordance with EN 60669-1 - antibacterial protection in accordance with JIS Z 2801 | |
| | <input type="checkbox"/> TM22AW | <p>POLNILO 2M</p> <ul style="list-style-type: none"> - za zapolnjevanje praznih mest - ustreza EN 60669-1 - antibakterijska zaščita skladna z JIS Z 2801 <p><i>BLANK 2M</i></p> <ul style="list-style-type: none"> - blank modul to fill up empty spaces - in accordance with EN 60669-1 - antibacterial protection in accordance with JIS Z 2801 | |

VTIČNICA SCHUKO+KS 2P+E 16A 250V~ 2M



□ VM10AW

- 2P+E schuko
- 16A 250V~, tip VM10
- ustreza IEC 60884-1, CEE7
- vijačna pritrditev vodnikov 1.5-2.5 mm²
- vgrajena zaščita pred dotikom kontaktov
- antibakterijska zaščita skladna z JIS Z 2801



SOCKET SCHUKO+KS 2P+E 16A 250V~ 2M

- 2P+E schuko
- 16A 250V~, type VM10
- in accordance with IEC 60884-1, CEE7
- screw contacts 1.5-2.5 mm²
- built-in contact protection
- antibacterial protection in accordance with JIS Z 2801

VTIČNICA SCHUKO+KS+POKROV 2P+E 16A 250V~ 2M



□ VM11AW

- 2P+E schuko+pokrov
- 16A 250V~, tip VM11
- ustreza IEC 60884-1, CEE7
- vijačna pritrditev vodnikov 1.5-2.5 mm²
- vgrajena zaščita pred dotikom kontaktov
- antibakterijska zaščita skladna z JIS Z 2801



SOCKET SCHUKO+KS+COVER

- 2P+E schuko+cover
- 16A 250V~, type VM11
- in accordance with IEC 60884-1, CEE7
- screw contacts 1.5-2.5 mm²
- built-in contact protection
- antibacterial protection in accordance with JIS Z 2801

VTIČNICA EURO+KS 2P 10A 250V~ 1M



□ VM20AW

- 2P euro
- 10A 250V~, tip VM20
- ustreza IEC 60884-1, CEE7
- vijačna pritrditev vodnikov 1.5-2.5 mm²
- vgrajena zaščita pred dotikom kontaktov
- antibakterijska zaščita skladna z JIS Z 2801



SOCKET EURO+KS 2P 10A 250V~ 1M

- 2P Euro
- 10A 250V~, type VM20
- in accordance with IEC 60884-1, CEE7
- screw contacts 1.5-2.5 mm²
- built-in contact protection
- antibacterial protection in accordance with JIS Z 2801

VTIČNICA TV KONČNA 1dB 1M



□ KM11AW

- TV končna
- frekvenčni pas 5÷2400 MHz
- dušenje < 1 dB
- ustreza EN 50083-1
- vijačna priključitev
- antibakterijska zaščita skladna z JIS Z 2801



SOCKET TV END-LINE 1dB 1M

- TV end-line
- frequency range 5÷2400 MHz
- reduction < 1 dB
- in accordance with EN 50083-1
- screw contacts
- antibacterial protection in accordance with JIS Z 2801

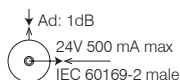

ADAPTER KS 1M



□ KM35AW

- KS keystone pritrditveni standard
- AMP, Avaya, Brandrex, FMT, Mfico, Tyco, ...
- komunikacijski modul ni vgrajen
- antibakterijska zaščita skladna z JIS Z 2801

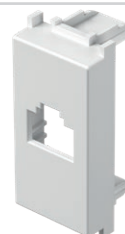

ADAPTER KS 1M

- KS keystone fixing standard
- AMP, Avaya, Brandrex, FMT, Mfico, Tyco, ...
- communication module not included
- antibacterial protection in accordance with JIS Z 2801

A N T I B A C T E R I A L P R O G R A M M O D U L



OS20AW

OKVIR SOFT 2M

- dekorativni okvir SOFT 2M
- ustreza EN 60669-1
- antibakterijska zaščita skladna z JIS Z 2801

COVER PLATE SOFT 2M

- decorative cover plate SOFT 2M
- in accordance with EN 60669-1
- antibacterial protection in accordance with JIS Z 2801



OS24AW

OKVIR SOFT 2x2M

- dekorativni okvir SOFT 2x2M
- horizontalna ali vertikalna vgradnja
- ustreza EN 60669-1
- antibakterijska zaščita skladna z JIS Z 2801

COVER PLATE SOFT 2x2M

- decorative cover plate SOFT 2x2M
- horizontal or vertical mounting
- in accordance with EN 60669-1
- antibacterial protection in accordance with JIS Z 2801



OS26AW

OKVIR SOFT 3x2M

- dekorativni okvir SOFT 3x2M
- horizontalna ali vertikalna vgradnja
- ustreza EN 60669-1
- antibakterijska zaščita skladna z JIS Z 2801

COVER PLATE SOFT 3x2M

- decorative cover plate SOFT 3x2M
- horizontal or vertical mounting
- in accordance with EN 60669-1
- antibacterial protection in accordance with JIS Z 2801

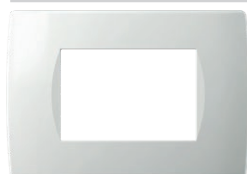

OS30AW

OKVIR SOFT 3M

- dekorativni okvir SOFT 3M
- ustreza EN 60669-1
- antibakterijska zaščita skladna z JIS Z 2801

COVER PLATE SOFT 3M

- decorative cover plate SOFT 3M
- in accordance with EN 60669-1
- antibacterial protection in accordance with JIS Z 2801

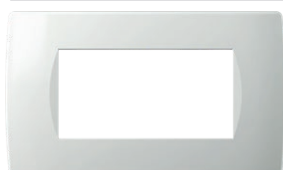

OS40AW

OKVIR SOFT 4M

- dekorativni okvir SOFT 4M
- ustreza EN 60669-1
- antibakterijska zaščita skladna z JIS Z 2801

COVER PLATE SOFT 4M

- decorative cover plate SOFT 4M
- in accordance with EN 60669-1
- antibacterial protection in accordance with JIS Z 2801

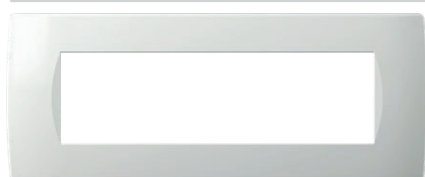

OS70AW

OKVIR SOFT 7M

- dekorativni okvir SOFT 7M
- ustreza EN 60669-1
- antibakterijska zaščita skladna z JIS Z 2801

COVER PLATE SOFT 7M

- decorative cover plate SOFT 7M
- in accordance with EN 60669-1
- antibacterial protection in accordance with JIS Z 2801

les
wood

WB bambus
bamboo



WW oreh
walnut



WM javor
maple



WE wenge
wenge



Narava je edinstvena in dragocena, kot naši okvirji, med katerimi ni enakega.

Reklamacij glede različnosti izgleda in medsebojnega razlikovanja pri lesenih okvirjih ne moremo upoštevati.

Nature is unique and precious, as our decorative cover plates where no two are the same.

Complaints about wooden decorative cover plate's diverse appearance and differentiation cannot be considered.

MODUL

PURE

C O V E R P L A T E S P U R E O P

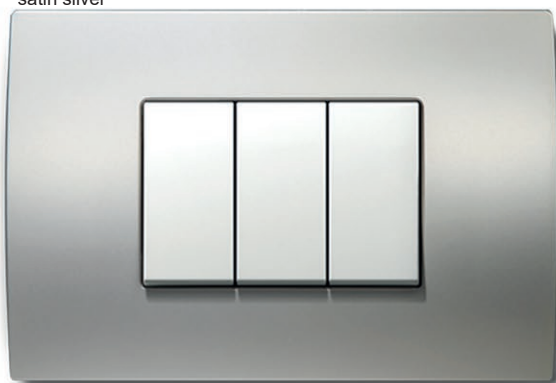
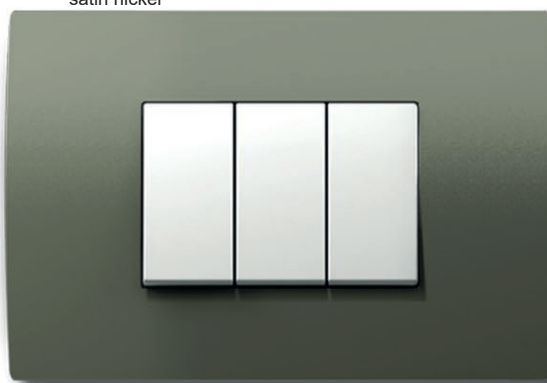
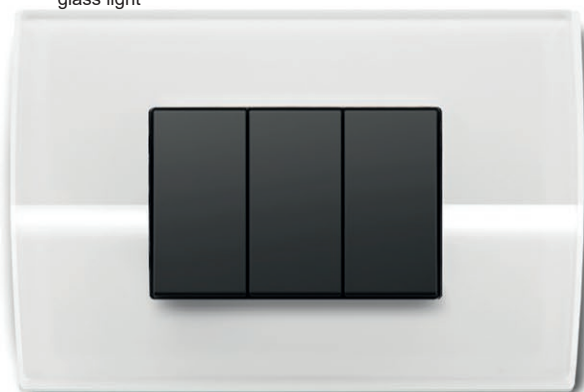
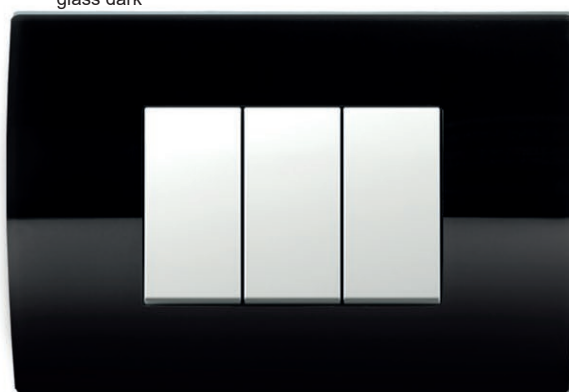
kovina
metalMH kovano jeklo
hammered steelME zarjavelo železo
etched ironMS satinirano srebro
satin silverMN satiniran nikelj
satin nickelsteklo
glassGL bela
glass lightGD črna
glass dark

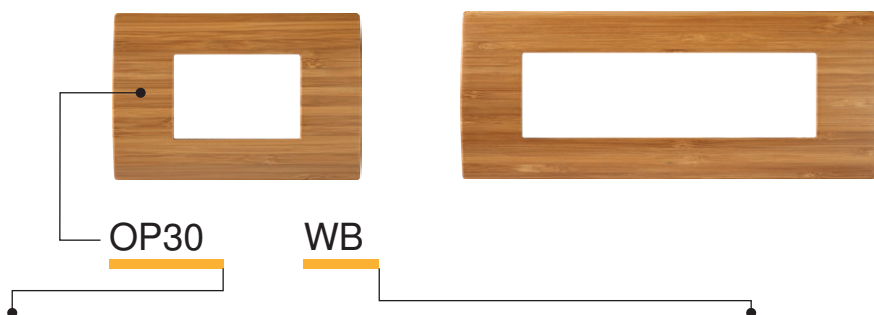

| tip type | naziv description | velikost size | barva colour | |
|----------|-----------------------------|---------------|-----------------------------------|------------------|
| OP13 | OKVIR PURE COVER PLATE PURE | 1/3M | MH kovano jeklo hammered steel | WB bambus bamboo |
| OP20 | OKVIR PURE COVER PLATE PURE | 2M | ME zarjavelo železo etched iron | WW oreh walnut |
| OP23 | OKVIR PURE COVER PLATE PURE | 2/3M | MS satinirano srebro satin silver | WM javor maple |
| . | . | . | MN satiniran nikelj satin nickel | WE wenge wenge |
| . | . | . | | |
| . | . | . | | |

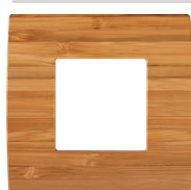

| | |
|--------|--------|
| OP20MH | OP20WB |
| OP20ME | OP20WW |
| OP20MS | OP20WM |
| OP20MN | OP20WE |
| | OP20GL |
| | OP20GD |

OKVIR PURE 2M

- dekorativni okvir PURE 2M
- ustreza EN 60669-1
- samo v kombinaciji z nosilcem NM24 ali NM25

COVER PLATE PURE 2M

- decorative cover plate PURE 2M
- in accordance with EN 60669-1
- only in combination with mounting frame NM24 or NM25

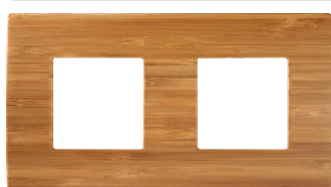

| | |
|--------|--------|
| OP24MH | OP24WB |
| OP24ME | OP24WW |
| OP24MS | OP24WM |
| OP24MN | OP24WE |
| | OP24GL |
| | OP24GD |

OKVIR PURE 2x2M

- dekorativni okvir PURE 2x2M
- horizontalna ali vertikalna vgradnja
- ustreza EN 60669-1
- samo v kombinaciji z nosilcema NM24 ali NM25

COVER PLATE PURE 2x2M

- decorative cover plate PURE 2x2M
- horizontal or vertical mounting
- in accordance with EN 60669-1
- only in combination with mounting frames NM24 or NM25



| | |
|--------|--------|
| OP26MH | OP26WB |
| OP26ME | OP26WW |
| OP26MS | OP26WM |
| OP26MN | OP26WE |
| | OP26GL |
| | OP26GD |

OKVIR PURE 3x2M

- dekorativni okvir PURE 3x2M
- horizontalna ali vertikalna vgradnja
- ustreza EN 60669-1
- samo v kombinaciji z nosilci NM24 ali NM25

COVER PLATE PURE 3x2M

- decorative cover plate PURE 3x2M
- horizontal or vertical mounting
- in accordance with EN 60669-1
- only in combination with mounting frames NM24 or NM25



| | |
|--------|--------|
| OP28MH | OP28WB |
| OP28ME | OP28WW |
| OP28MS | OP28WM |
| OP28MN | OP28WE |
| | OP28GL |
| | OP28GD |

OKVIR PURE 4x2M

- dekorativni okvir PURE 4x2M
- horizontalna ali vertikalna vgradnja
- ustreza EN 60669-1
- samo v kombinaciji z nosilci NM24 ali NM25

COVER PLATE PURE 4x2M

- decorative cover plate PURE 4x2M
- horizontal or vertical mounting
- in accordance with EN 60669-1
- only in combination with mounting frames NM24 or NM25

COVER PLATES PURE OP



| | | | |
|--|--------|--|--------|
| | OP30MH | | OP30WB |
| | OP30ME | | OP30WW |
| | OP30MS | | OP30WM |
| | OP30MN | | OP30WE |
| | | | OP30GL |
| | | | OP30GD |

OKVIR PURE 3M

- dekorativni okvir PURE 3M
- ustreza EN 60669-1

COVER PLATE PURE 3M

- decorative cover plate PURE 3M
- in accordance with EN 60669-1

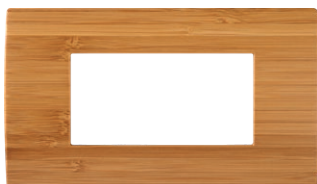

| | | | |
|--|--------|--|--------|
| | OP40MH | | OP40WB |
| | OP40ME | | OP40WW |
| | OP40MS | | OP40WM |
| | OP40MN | | OP40WE |
| | | | OP40GL |
| | | | OP40GD |

OKVIR PURE 4M

- dekorativni okvir PURE 4M
- ustreza EN 60669-1

COVER PLATE PURE 4M

- decorative cover plate PURE 4M
- in accordance with EN 60669-1



| | | | |
|--|--------|--|--------|
| | OP70MH | | OP70WB |
| | OP70ME | | OP70WW |
| | OP70MS | | OP70WM |
| | OP70MN | | OP70WE |
| | | | OP70GL |
| | | | OP70GD |

OKVIR PURE 7M

- dekorativni okvir PURE 7M
- ustreza EN 60669-1

COVER PLATE PURE 7M

- decorative cover plate PURE 7M
- in accordance with EN 60669-1



| | | | |
|--|--------|--|--------|
| | OP13MH | | OP13WB |
| | OP13ME | | OP13WW |
| | OP13MS | | OP13WM |
| | OP13MN | | OP13WE |
| | | | OP13GL |
| | | | OP13GD |

OKVIR PURE 1/3M

- dekorativni okvir PURE 1/3M
- ustreza EN 60669-1

COVER PLATE PURE 1/3M

- decorative cover plate PURE 1/3M
- in accordance with EN 60669-1



| | | | |
|--|--------|--|--------|
| | OP23MH | | OP23WB |
| | OP23ME | | OP23WW |
| | OP23MS | | OP23WM |
| | OP23MN | | OP23WE |
| | | | OP23GL |
| | | | OP23GD |

OKVIR PURE 2/3M

- dekorativni okvir PURE 2/3M
- ustreza EN 60669-1

COVER PLATE PURE 2/3M

- decorative cover plate PURE 2/3M
- in accordance with EN 60669-1

basic
basic

PW bela-sijaj
polar white

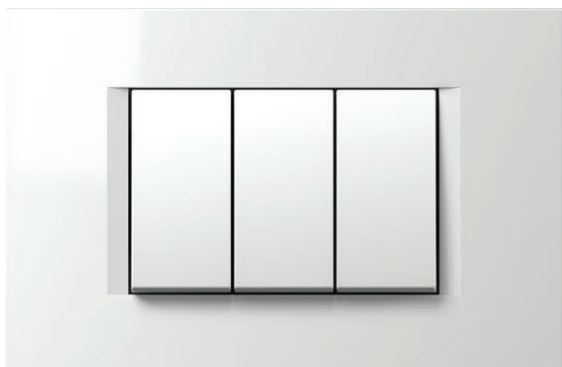

IW bež-sijaj
ivory white

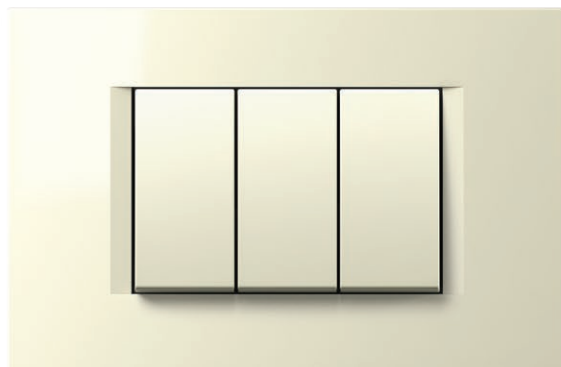

ES srebrna-mat
elox silver



SB črna-mat
soft touch black



AT antracit
anthracite

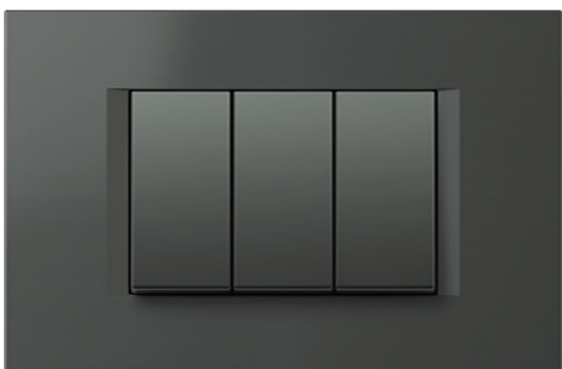

MW bela-mat
matte white

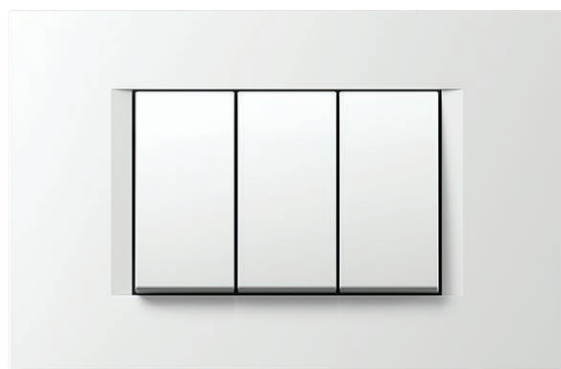

COVER PLATES LINE OL

dekor
decor

SG zlata-mat
sand gold

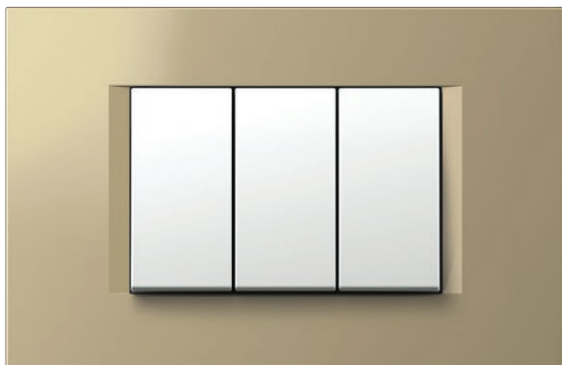

NB črna-sijaj
night black

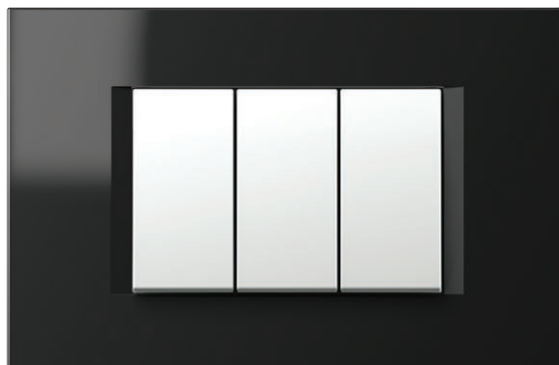

IB modra-mat
impulse blue



TI titan
titanium



SW kamen beli
stone white



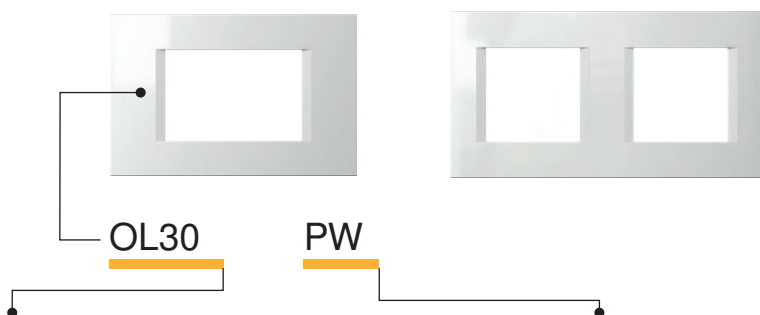

| tip type | naziv description | velikost size | barva colour | | | | | | | | | | | | | | | | | | | | | | | | |
|-------------|--------------------------------|------------------|---|--|----|------------|------------------|--|----|------------|--------------|--|----|------------|-------------|--|----|-------------|-------------|--|----|----------|------------------|--|--|--|--|
| OL10 | OKVIR LINE COVER PLATE LINE | 1/2M | <table border="0"> <tr> <td></td> <td>PW</td> <td>bela-sijaj</td> <td>polar white</td> <td></td> <td>SG</td> <td>zlata-mat</td> <td>sand gold</td> <td></td> <td>AT</td> <td>antracit</td> <td>anthracite</td> </tr> </table> | | PW | bela-sijaj | polar white | | SG | zlata-mat | sand gold | | AT | antracit | anthracite | | | | | | | | | | | | |
| | PW | bela-sijaj | polar white | | SG | zlata-mat | sand gold | | AT | antracit | anthracite | | | | | | | | | | | | | | | | |
| OL13 | OKVIR LINE COVER PLATE LINE | 1/3M | <table border="0"> <tr> <td></td> <td>MW</td> <td>bela- mat</td> <td>matte white</td> <td></td> <td>NB</td> <td>črna-sijaj</td> <td>night black</td> <td></td> <td>TI</td> <td>titan</td> <td>titanium</td> </tr> </table> | | MW | bela- mat | matte white | | NB | črna-sijaj | night black | | TI | titan | titanium | | | | | | | | | | | | |
| | MW | bela- mat | matte white | | NB | črna-sijaj | night black | | TI | titan | titanium | | | | | | | | | | | | | | | | |
| OL20 | OKVIR LINE COVER PLATE LINE | 2M | <table border="0"> <tr> <td></td> <td>IW</td> <td>bež-sijaj</td> <td>ivory white</td> <td></td> <td>IB</td> <td>modra-mat</td> <td>impulse blue</td> <td></td> <td>SW</td> <td>kamen beli</td> <td>stone white</td> </tr> <tr> <td></td> <td>ES</td> <td>srebrna-mat</td> <td>elox silver</td> <td></td> <td>SB</td> <td>črna-mat</td> <td>soft touch black</td> <td></td> <td></td> <td></td> <td></td> </tr> </table> | | IW | bež-sijaj | ivory white | | IB | modra-mat | impulse blue | | SW | kamen beli | stone white | | ES | srebrna-mat | elox silver | | SB | črna-mat | soft touch black | | | | |
| | IW | bež-sijaj | ivory white | | IB | modra-mat | impulse blue | | SW | kamen beli | stone white | | | | | | | | | | | | | | | | |
| | ES | srebrna-mat | elox silver | | SB | črna-mat | soft touch black | | | | | | | | | | | | | | | | | | | | |



OKVIR LINE 2M

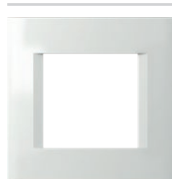

| | | | |
|--|--------|--|--------|
| | OL20PW | | OL20SG |
| | OL20MW | | OL20NB |
| | OL20IW | | OL20IB |
| | OL20ES | | OL20AT |
| | OL20SB | | OL20TI |
| | | | OL20SW |

- dekorativni okvir LINE 2M
- ustreza EN 60669-1

COVER PLATE LINE 2M
- decorative cover plate LINE 2M
- in accordance with EN 60669-1

OKVIR LINE 2x2M



| | | | |
|--|--------|--|--------|
| | OL24PW | | OL24SG |
| | OL24MW | | OL24NB |
| | OL24IW | | OL24IB |
| | OL24ES | | OL24AT |
| | OL24SB | | OL24TI |
| | | | OL24SW |

- dekorativni okvir LINE 2x2M
- horizontalna ali vertikalna vgradnja
- ustreza EN 60669-1

COVER PLATE LINE 2x2M
- decorative cover plate LINE 2x2M
- horizontal or vertical mounting
- in accordance with EN 60669-1

OKVIR LINE 3x2M

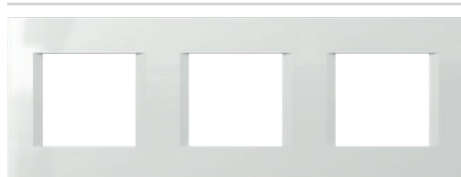

| | | | |
|--|--------|--|--------|
| | OL26PW | | OL26SG |
| | OL26MW | | OL26NB |
| | OL26IW | | OL26IB |
| | OL26ES | | OL26AT |
| | OL26SB | | OL26TI |
| | | | OL26SW |

- dekorativni okvir LINE 3x2M
- horizontalna ali vertikalna vgradnja
- ustreza EN 60669-1

COVER PLATE LINE 3x2M
- decorative cover plate LINE 3x2M
- horizontal or vertical mounting
- in accordance with EN 60669-1

OKVIR LINE 4x2M



| | | | |
|--|--------|--|--------|
| | OL28PW | | OL28SG |
| | OL28MW | | OL28NB |
| | OL28IW | | OL28IB |
| | OL28ES | | OL28AT |
| | OL28SB | | OL28TI |
| | | | OL28SW |

- dekorativni okvir LINE 4x2M
- horizontalna ali vertikalna vgradnja
- ustreza EN 60669-1

COVER PLATE LINE 4x2M
- decorative cover plate LINE 4x2M
- horizontal or vertical mounting
- in accordance with EN 60669-1

OKVIR LINE 5x2M

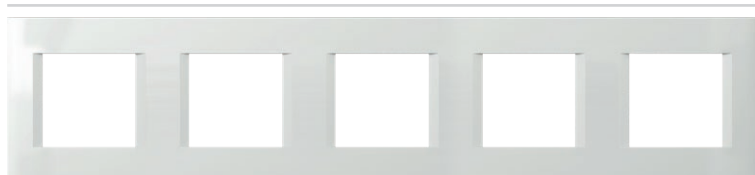

| | |
|--|--------|
| | OL29PW |
| | OL29MW |
| | OL29IW |
| | OL29ES |
| | OL29SB |
| | OL29AT |
| | OL29TI |

- dekorativni okvir LINE 5x2M
- horizontalna ali vertikalna vgradnja
- ustreza EN 60669-1

COVER PLATE LINE 5x2M
- decorative cover plate LINE 5x2M
- horizontal or vertical mounting
- in accordance with EN 60669-1

COVER PLATES LINE OL

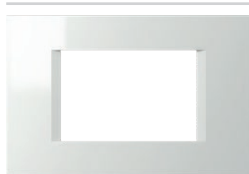

| | | | |
|--|--------|--|--------|
| | OL30PW | | OL30SG |
| | OL30MW | | OL30NB |
| | OL30IW | | OL30IB |
| | OL30ES | | OL30AT |
| | OL30SB | | OL30TI |
| | | | OL30SW |

OKVIR LINE 3M

- dekorativni okvir LINE 3M
- ustreza EN 60669-1

COVER PLATE LINE 3M
- decorative cover plate LINE 3M
- in accordance with EN 60669-1

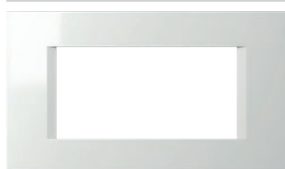

| | | | |
|--|--------|--|--------|
| | OL40PW | | OL40SG |
| | OL40MW | | OL40NB |
| | OL40IW | | OL40IB |
| | OL40ES | | OL40AT |
| | OL40SB | | OL40TI |
| | | | OL40SW |

OKVIR LINE 4M

- dekorativni okvir LINE 4M
- ustreza EN 60669-1

COVER PLATE LINE 4M
- decorative cover plate LINE 4M
- in accordance with EN 60669-1

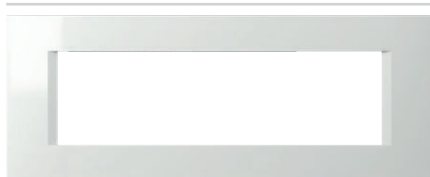

| | | | |
|--|--------|--|--------|
| | OL70PW | | OL70SG |
| | OL70MW | | OL70NB |
| | OL70IW | | OL70IB |
| | OL70ES | | OL70AT |
| | OL70SB | | OL70TI |
| | | | OL70SW |

OKVIR LINE 7M

- dekorativni okvir LINE 7M
- ustreza EN 60669-1

COVER PLATE LINE 7M
- decorative cover plate LINE 7M
- in accordance with EN 60669-1



| | | | |
|--|--------|--|--------|
| | OL71PW | | OL71AT |
| | OL71MW | | OL71TI |
| | OL71IW | | |
| | OL71ES | | |
| | OL71SB | | |

OKVIR LINE 2x7M

- dekorativni okvir LINE 2x7M
- ustreza EN 60669-1

COVER PLATE LINE 2x7M
- decorative cover plate LINE 2x7M
- in accordance with EN 60669-1



| | | | |
|--|--------|--|--------|
| | OL10PW | | OL10SG |
| | OL10MW | | OL10NB |
| | OL10IW | | OL10IB |
| | OL10ES | | OL10AT |
| | OL10SB | | OL10TI |
| | | | OL10SW |

OKVIR LINE 1/2M

- dekorativni okvir LINE 1/2M
- ustreza EN 60669-1

COVER PLATE LINE 1/2M
- decorative cover plate LINE 1/2M
- in accordance with EN 60669-1

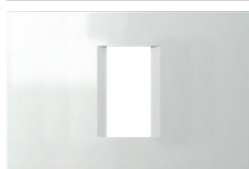

| | | | |
|--|--------|--|--------|
| | OL13PW | | OL13SG |
| | OL13MW | | OL13NB |
| | OL13IW | | OL13IB |
| | OL13ES | | OL13AT |
| | OL13SB | | OL13TI |
| | | | OL13SW |

OKVIR LINE 1/3M

- dekorativni okvir LINE 1/3M
- ustreza EN 60669-1

COVER PLATE LINE 1/3M
- decorative cover plate LINE 1/3M
- in accordance with EN 60669-1

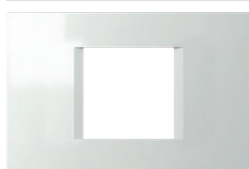

| | | | |
|--|--------|--|--------|
| | OL23PW | | OL23SG |
| | OL23MW | | OL23NB |
| | OL23IW | | OL23IB |
| | OL23ES | | OL23AT |
| | OL23SB | | OL23TI |
| | | | OL23SW |

OKVIR LINE 2/3M

- dekorativni okvir LINE 2/3M
- ustreza EN 60669-1

COVER PLATE LINE 2/3M
- decorative cover plate LINE 2/3M
- in accordance with EN 60669-1

basic
basic

PW bela-sijaj
polar white

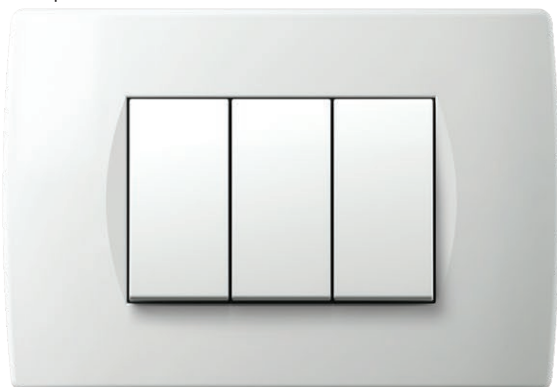

IW bež-sijaj
ivory white

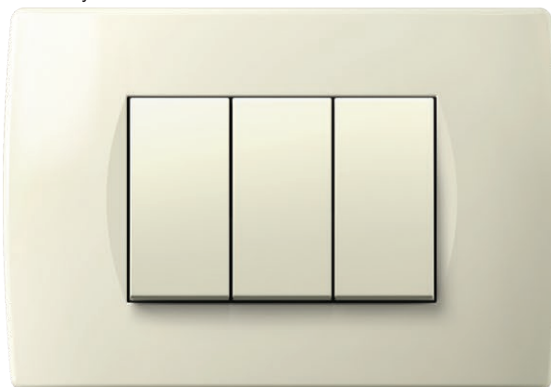

ES srebrna-mat
elox silver

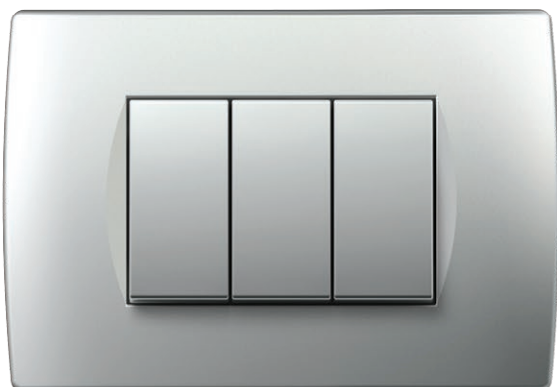

SB črna-mat
soft touch black

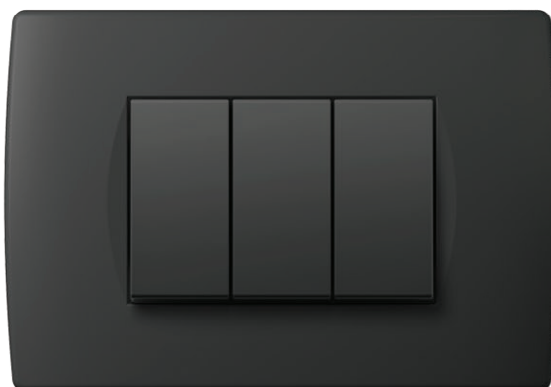

AT antracit
anthracite



MW bela-mat
matte white

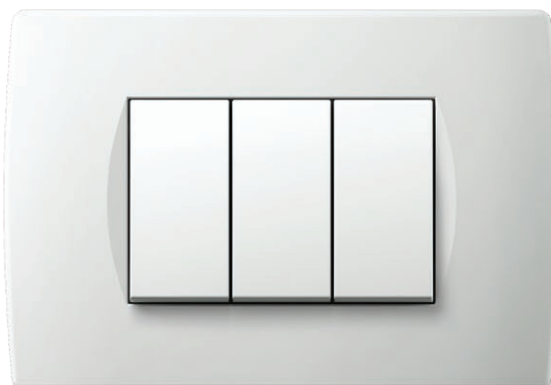

COVER PLATES SOFT OS

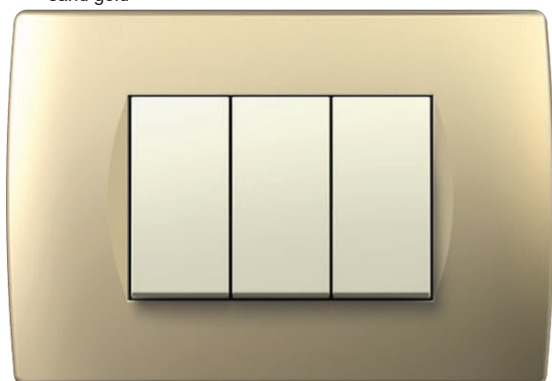
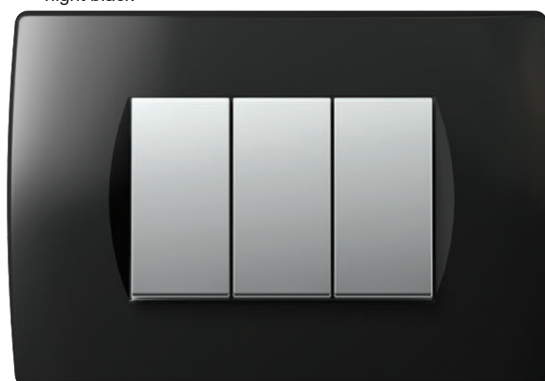
dekor
decorSG zlata-mat
sand goldNB črna-sijaj
night blackTI titan
titaniumWE wenge
wengeWW oreh
walnut

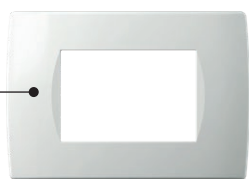

OS30

PW

| tip type | naziv description | velikost size | barva colour | | | | | | | | | |
|------------------------------|-----------------------------|----------------|--|---------------------------|---------------------------|----------------|----------------------------|-------------------|--|------------------------------|--|--|
| OS10 | OKVIR SOFT COVER PLATE SOFT | 1/2M | <table border="0"> <tr> <td> PW bela-sijaj polar white</td> <td> SG zlata-mat sand gold</td> <td> WW oreh walnut</td> </tr> </table> | PW bela-sijaj polar white | SG zlata-mat sand gold | WW oreh walnut | | | | | | |
| PW bela-sijaj polar white | SG zlata-mat sand gold | WW oreh walnut | | | | | | | | | | |
| OS13 | OKVIR SOFT COVER PLATE SOFT | 1/3M | <table border="0"> <tr> <td> MW bela-mat matte white</td> <td> NB črna-sijaj night black</td> <td> WE wenge wenge</td> </tr> </table> | MW bela-mat matte white | NB črna-sijaj night black | WE wenge wenge | | | | | | |
| MW bela-mat matte white | NB črna-sijaj night black | WE wenge wenge | | | | | | | | | | |
| OS20 | OKVIR SOFT COVER PLATE SOFT | 2M | <table border="0"> <tr> <td> IW bež-sijaj ivory white</td> <td> AT antracit anthracite</td> <td></td> </tr> <tr> <td> ES srebrna-mat elox silver</td> <td> TI titan titanium</td> <td></td> </tr> <tr> <td> SB črna-mat soft touch black</td> <td></td> <td></td> </tr> </table> | IW bež-sijaj ivory white | AT antracit anthracite | | ES srebrna-mat elox silver | TI titan titanium | | SB črna-mat soft touch black | | |
| IW bež-sijaj ivory white | AT antracit anthracite | | | | | | | | | | | |
| ES srebrna-mat elox silver | TI titan titanium | | | | | | | | | | | |
| SB črna-mat soft touch black | | | | | | | | | | | | |



| | |
|--------|--------|
| OS20PW | OS20SG |
| OS20MW | OS20NB |
| OS20IW | OS20AT |
| OS20ES | OS20TI |
| OS20SB | OS20WW |
| | OS20WE |

OKVIR SOFT 2M

- dekorativni okvir SOFT 2M
- ustreza EN 60669-1

COVER PLATE SOFT 2M

- decorative cover plate SOFT 2M
- in accordance with EN 60669-1



| | |
|--------|--------|
| OS24PW | OS24SG |
| OS24MW | OS24NB |
| OS24IW | OS24AT |
| OS24ES | OS24TI |
| OS24SB | OS24WW |
| | OS24WE |

OKVIR SOFT 2x2M

- dekorativni okvir SOFT 2x2M
- horizontalna ali vertikalna vgradnja
- ustreza EN 60669-1

COVER PLATE SOFT 2x2M

- decorative cover plate SOFT 2x2M
- horizontal or vertical mounting
- in accordance with EN 60669-1

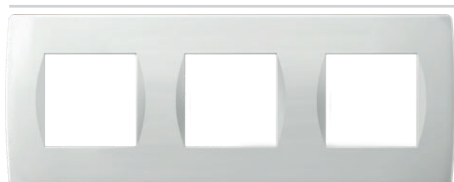

| | |
|--------|--------|
| OS26PW | OS26SG |
| OS26MW | OS26NB |
| OS26IW | OS26AT |
| OS26ES | OS26TI |
| OS26SB | OS26WW |
| | OS26WE |

OKVIR SOFT 3x2M

- dekorativni okvir SOFT 3x2M
- horizontalna ali vertikalna vgradnja
- ustreza EN 60669-1

COVER PLATE SOFT 3x2M

- decorative cover plate SOFT 3x2M
- horizontal or vertical mounting
- in accordance with EN 60669-1



| | |
|--------|--------|
| OS28PW | OS28SG |
| OS28MW | OS28NB |
| OS28IW | OS28AT |
| OS28ES | OS28TI |
| OS28SB | OS28WW |
| | OS28WE |

OKVIR SOFT 4x2M

- dekorativni okvir SOFT 4x2M
- horizontalna ali vertikalna vgradnja
- ustreza EN 60669-1

COVER PLATE SOFT 4x2M

- decorative cover plate SOFT 4x2M
- horizontal or vertical mounting
- in accordance with EN 60669-1

MODUL

SOFT

COVER PLATES SOFT OS

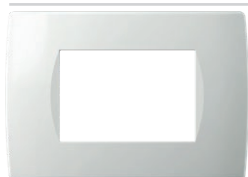

| | |
|--|--|
|  OS30PW |  OS30SG |
|  OS30MW |  OS30NB |
|  OS30IW |  OS30AT |
|  OS30ES |  OS30TI |
|  OS30SB |  OS30WW |
| |  OS30WE |

OKVIR SOFT 3M

- dekorativni okvir SOFT 3M
- ustreza EN 60669-1

COVER PLATE SOFT 3M

- decorative cover plate SOFT 3M
- in accordance with EN 60669-1



| | |
|--|--|
|  OS40PW |  OS40SG |
|  OS40MW |  OS40NB |
|  OS40IW |  OS40AT |
|  OS40ES |  OS40TI |
|  OS40SB |  OS40WW |
| |  OS40WE |

OKVIR SOFT 4M

- dekorativni okvir SOFT 4M
- ustreza EN 60669-1

COVER PLATE SOFT 4M

- decorative cover plate SOFT 4M
- in accordance with EN 60669-1

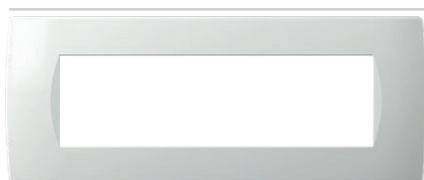

| | |
|--|--|
|  OS70PW |  OS70SG |
|  OS70MW |  OS70NB |
|  OS70IW |  OS70AT |
|  OS70ES |  OS70TI |
|  OS70SB |  OS70WW |
| |  OS70WE |







OKVIR SOFT 7M

- dekorativni okvir SOFT 7M
- ustreza EN 60669-1

COVER PLATE SOFT 7M

- decorative cover plate SOFT 7M
- in accordance with EN 60669-1



| | |
|--|--|
|  OS71PW |  OS71AT |
|  OS71MW |  OS71TI |
|  OS71IW | |
|  OS71ES | |
|  OS71SB | |







OKVIR SOFT 2x7M

- dekorativni okvir SOFT 2x7M
- ustreza EN 60669-1

COVER PLATE SOFT 2x7M

- decorative cover plate SOFT 2x7M
- in accordance with EN 60669-1



| | |
|--|--|
|  OS72PW |  OS72SG |
|  OS72IW |  OS72AT |
|  OS72ES |  OS72TI |
|  OS72SB | |

OKVIR SOFT 2x7M Z NAPISNO PLOŠČICO

- dekorativni okvir SOFT 2x7M z
napisno ploščico
- ustreza EN 60669-1

COVER PLATE SOFT 2x7M

- decorative cover plate SOFT 2x7M
with inscription plate
- in accordance with EN 60669-1



| | |
|--|--|
|  OS10PW |  OS10SG |
|  OS10MW |  OS10NB |
|  OS10IW |  OS10AT |
|  OS10ES |  OS10TI |
|  OS10SB |  OS10WW |
| |  OS10WE |











OKVIR SOFT 1/2M

- dekorativni okvir SOFT 1/2M
- ustreza EN 60669-1

COVER PLATE SOFT 1/2M

- decorative cover plate SOFT 1/2M
- in accordance with EN 60669-1



| | |
|--|--|
|  OS13PW |  OS13SG |
|  OS13MW |  OS13NB |
|  OS13IW |  OS13AT |
|  OS13ES |  OS13TI |
|  OS13SB |  OS13WW |
| |  OS13WE |

OKVIR SOFT 1/3M

- dekorativni okvir SOFT 1/3M
- ustreza EN 60669-1

COVER PLATE SOFT 1/3M

- decorative cover plate SOFT 1/3M
- in accordance with EN 60669-1

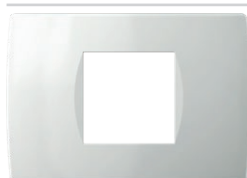

| | |
|--|--|
|  OS23PW |  OS23SG |
|  OS23MW |  OS23NB |
|  OS23IW |  OS23AT |
|  OS23ES |  OS23TI |
|  OS23SB |  OS23WW |
| |  OS23WE |

OKVIR SOFT 2/3M

- dekorativni okvir SOFT 2/3M
- ustreza EN 60669-1

COVER PLATE SOFT 2/3M

- decorative cover plate SOFT 2/3M
- in accordance with EN 60669-1

DEKORACIJE OKVIRJEV







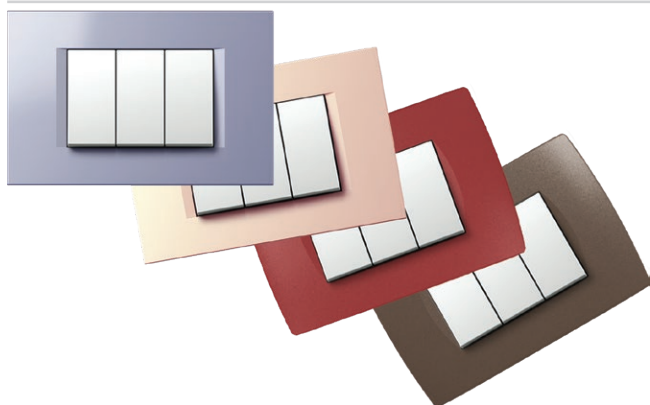



- pri večjem naročilu naredimo dekorativne okvirje v barvi po vaših željah
- primerno za okvirje OL, OS

COVER PLATES DECORATIONS

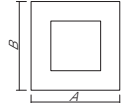
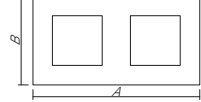
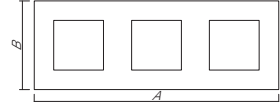
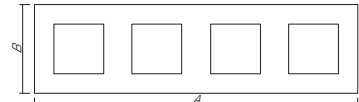
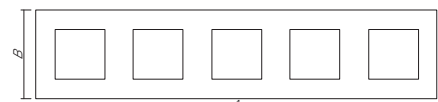
- when ordering large quantities, cover plates can be made in the
colour of your choice
- suitable for cover plates OL, OS

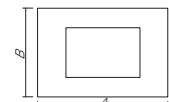

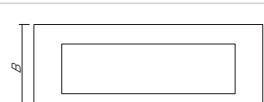
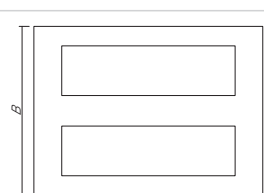
F R A M E S

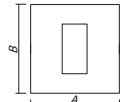
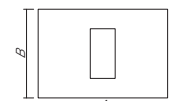
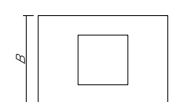
|  |  MODUL LINE A x B |  MODUL SOFT A x B |  MODUL PURE A x B |
|--|---|---|---|
| 2M  | 80 x 80 mm | 84 x 84 mm | 93 x 90 mm |
| 2x2M  | 151 x 80 mm | 155 x 84 mm | 164 x 90 mm |
| 3x2M  | 222 x 80 mm | 226 x 84 mm | 235 x 90 mm |
| 4x2M  | 293 x 80 mm | 297 x 84 mm | 304 x 90 mm |
| 5x2M  | 364,1 x 80 mm | | |
|  | | | |
| 3M  | 122 x 80 mm | 122 x 84 mm | 134 x 90 mm |
| 4M  | 149 x 80 mm | 144 x 84 mm | 157 x 90 mm |
| 7M  | 207 x 80 mm | 212 x 84 mm | 224 x 90 mm |
| 2x7M  | 215 x 159 mm | 212 x 158 mm | |
|  | | | |
| 1/2M  | 80 x 80 mm | 84 x 84 mm | |
| 1/3M  | 122 x 80 mm | 122 x 84 mm | 134 x 90 mm |
| 2/3M  | 122 x 80 mm | 122 x 84 mm | 134 x 90 mm |

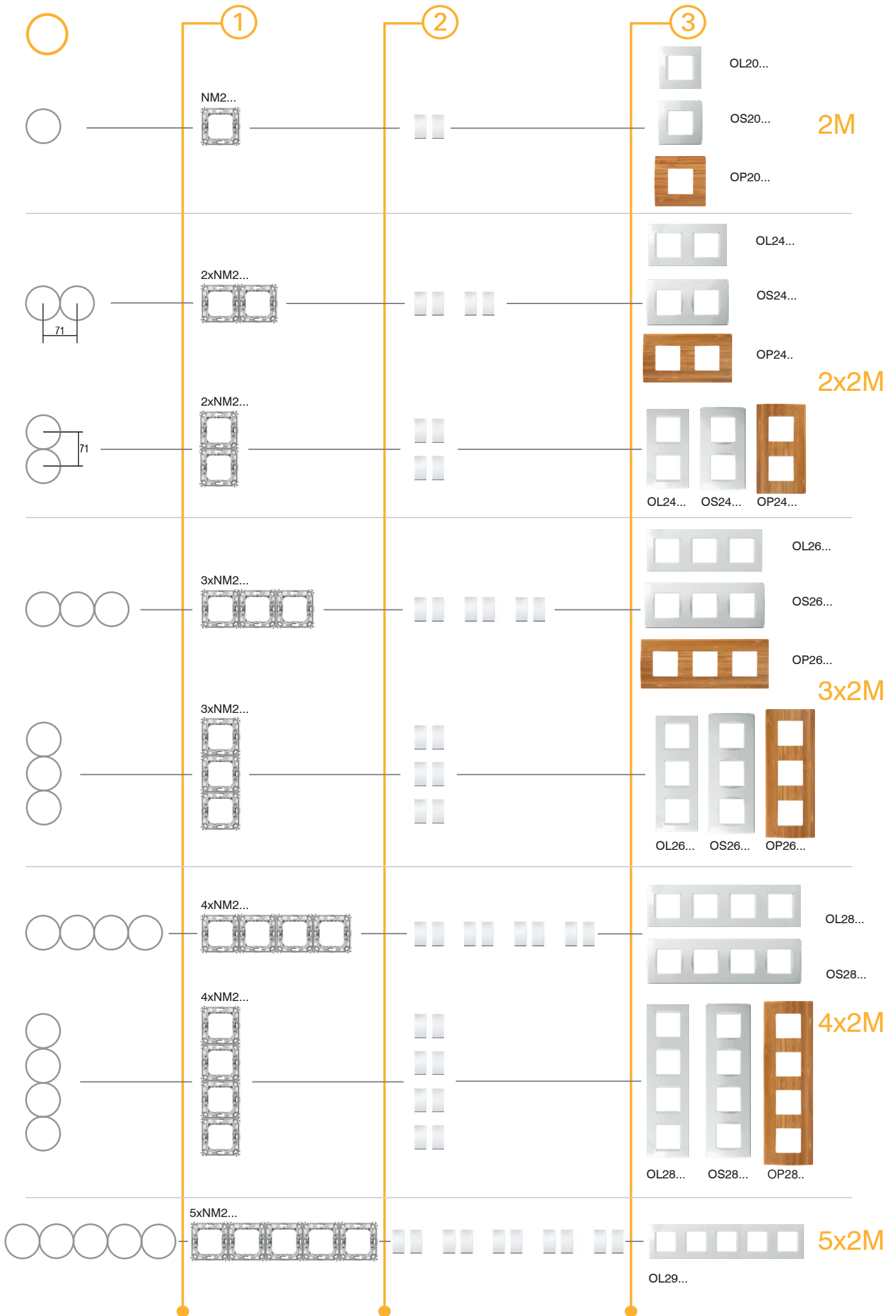

C O M B I N A T I O N S

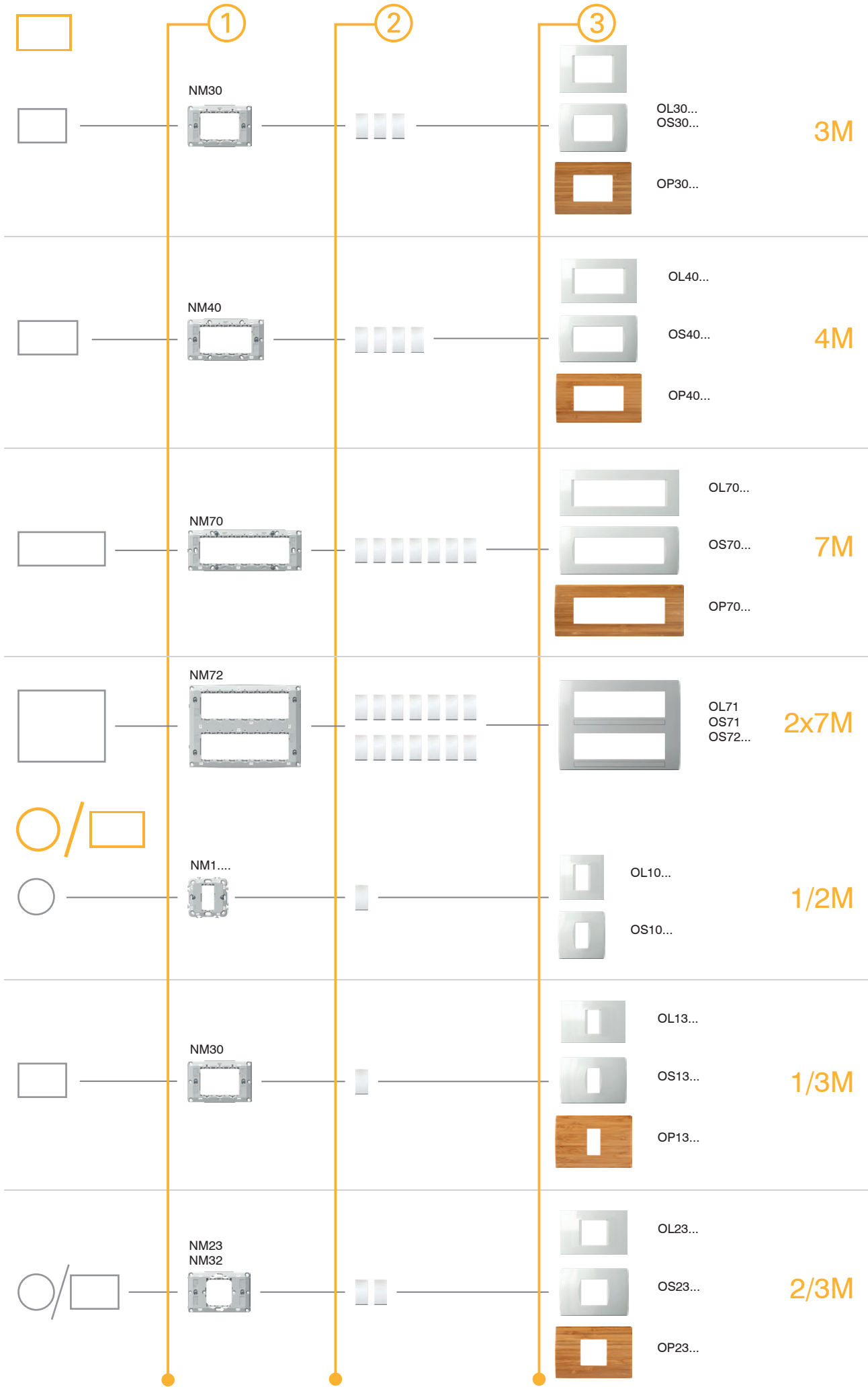

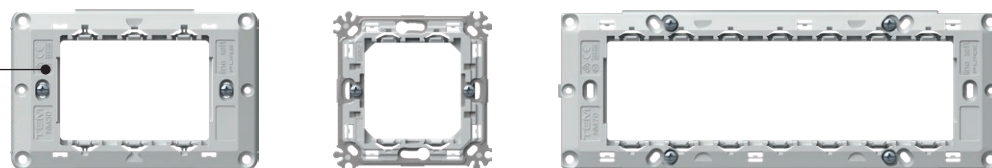

NM30

| tip type | naziv description | velikost size |
|-------------|---|------------------|
| NM10 | NOSILEC S KREPELJCI MOUNTING FRAME WITH CLAWS | 1/2M |
| NM11 | NOSILEC BREZ VIJAKOV MOUNTING FRAME WITHOUT SCREWS | 1/2M |
| NM20 | NOSILEC S KREPELJCI MOUNTING FRAME WITH CLAWS | 2M |
| ... | ... | ... |



NOSILEC S KREPELJCI 2M

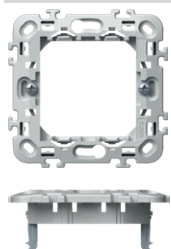

NM20

- nosilec 2M s krepeljci
- montaža v doze Ø60 (DE...) s krepeljci
- možno horizontalno ali vertikalno nizanje 2x2M, 3x2M in 4x2M
- primeren za sestavo z okvirji LINE in SOFT
- ustreza EN 60669-1

MOUNTING FRAME WITH CLAWS 2M

- mounting frame 2M with claws
- for mounting on boxes Ø60 (DE...) with claws
- possible horizontal or vertical combinations 2x2M, 3x2M and 4x2M
- suitable for assembling with cover plates LINE and SOFT
- in accordance with EN 60669-1

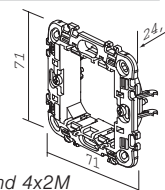

NOSILEC BREZ VIJAKOV 2M

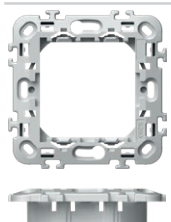

NM21

- nosilec 2M brez vijakov in brez krepeljcev
- montaža v doze Ø60 (HE..., BE...) z vijaki
- možno horizontalno ali vertikalno nizanje 2x2M, 3x2M in 4x2M
- primeren za sestavo z okvirji LINE in SOFT
- ustreza EN 60669-1

MOUNTING FRAME WITHOUT SCREWS 2M

- mounting frame 2M without screws and without claws
- for mounting on boxes Ø60 (HE..., BE...) with screws
- possible horizontal or vertical combinations 2x2M, 3x2M and 4x2M
- suitable for assembling with cover plates LINE and SOFT
- in accordance with EN 60669-1

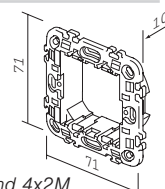

NOSILEC KOVINSKI S KREPELJCI 2M

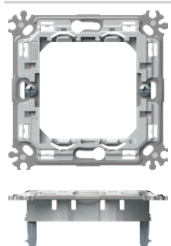

NM24

- kovinski nosilec 2M s krepeljci - toga izvedba
- montaža v doze Ø60 (DE...) s krepeljci
- možno horizontalno ali vertikalno nizanje 2x2M, 3x2M in 4x2M
- primeren za sestavo z okvirji PURE, LINE in SOFT
- ustreza EN 60669-1

MOUNTING FRAME METAL WITH CLAWS 2M

- metal mounting frame 2M with claws - stiff version
- for mounting on boxes Ø60 (DE...) with claws
- possible horizontal or vertical combinations 2x2M, 3x2M and 4x2M
- suitable for assembling with cover plates PURE, LINE and SOFT
- in accordance with EN 60669-1

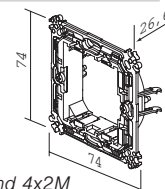

NOSILEC KOVINSKI BREZ VIJAKOV 2M

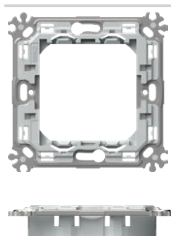

NM25

- kovinski nosilec brez vijakov in brez krepeljcev - toga izvedba
- montaža v doze Ø60 (HE..., BE...) z vijaki
- možno horizontalno ali vertikalno nizanje 2x2M, 3x2M in 4x2M
- primeren za sestavo z okvirji PURE, LINE in SOFT
- ustreza EN 60669-1

MOUNTING FRAME METAL WITHOUT SCREWS 2M

- metal mounting frame 2M without screws and without claws - stiff version
- for mounting in boxes Ø60 (HE..., BE...) with screws
- possible horizontal or vertical combinations 2x2M, 3x2M and 4x2M
- suitable for assembling with cover plates PURE, LINE and SOFT
- in accordance with EN 60669-1

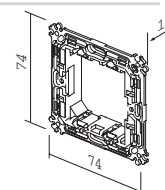

M O U N T I N G F R A M E S N M



| | | | |
|--|------|---|--|
| | NM10 | <p>NOSILEC S KREPELJCI 1/2M</p> <ul style="list-style-type: none"> - nosilec 1/2M s krepeljci - montaža v doze Ø60 (DE..) s krepeljci - primeren za sestavo z okvirji LINE in SOFT - ustreza EN 60669-1 | |
| | NM11 | <p>NOSILEC BREZ VIJAKOV 1/2M</p> <ul style="list-style-type: none"> - nosilec 1/2M brez vijakov in brez krepeljcev - montaža v doze Ø60 (HE., BE..) z vijaki - primeren za sestavo z okvirji LINE in SOFT - ustreza EN 60669-1 | |
| | NM23 | <p>NOSILEC S KREPELJCI 2/3M</p> <ul style="list-style-type: none"> - nosilec 2/3M s krepeljci - montaža v doze Ø60 (DE..) s krepeljci - primeren za sestavo z okvirji PURE, LINE in SOFT - ustreza EN 60669-1 | |

MOUNTING FRAME WITH CLAWS 1/2M

- mounting frame 1/2M with claws
- for mounting on boxes Ø60 (DE..) with claws
- suitable for assembling with cover plates LINE and SOFT
- in accordance with EN 60669-1

MOUNTING FRAME WITHOUT SCREWS 1/2M

- mounting frame 1/2M without screws and without claws
- for mounting on boxes Ø60 (HE., BE..) with screws
- suitable for assembling with cover plates LINE and SOFT
- in accordance with EN 60669-1

MOUNTING FRAME WITH CLAWS 2/3M

- mounting frame 2/3M with claws
- for mounting on boxes Ø60 (DE..) with claws
- suitable for assembling with cover plates PURE, LINE and SOFT
- in accordance with EN 60669-1

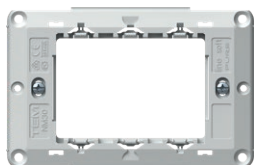

NM30

NOSILEC Z VIJAKI 3M

- nosilec 3M z vijaki
- montaža v pravokotne doze velikosti 3M
- primeren za sestavo z okvirji PURE, LINE in SOFT
- ustreza EN 60669-1

MOUNTING FRAME WITH SCREWS 3M

- mounting frame 3M with screws
- for mounting on rectangular boxes 3M
- suitable for assembling with cover plates PURE, LINE and SOFT
- in accordance with EN 60669-1

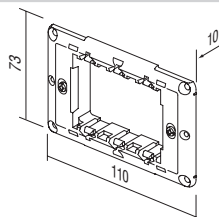

NM40

NOSILEC Z VIJAKI 4M

- nosilec 4M z vijaki
- montaža v pravokotne doze velikosti 4M
- primeren za sestavo z okvirji PURE, LINE in SOFT
- ustreza EN 60669-1

MOUNTING FRAME WITH SCREWS 4M

- mounting frame 4M with screws
- for mounting on rectangular boxes 4M
- suitable for assembling with cover plates PURE, LINE and SOFT
- in accordance with EN 60669-1

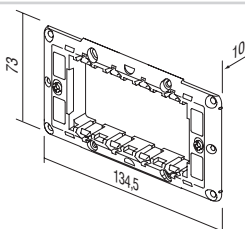

NM70

NOSILEC Z VIJAKI 7M

- nosilec 7M z vijaki
- montaža v pravokotne doze velikosti 7M
- primeren za sestavo z okvirji 2x 7M
- ustreza EN 60669-1

MOUNTING FRAME WITH SCREWS 7M

- mounting frame 7M with screws
- for mounting on rectangular boxes 7M
- suitable for assembling with cover plates 2x 7M
- in accordance with EN 60669-1

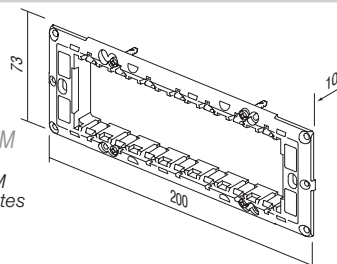

NM72

NOSILEC Z VIJAKI 2x7M

- nosilec 2x7M z vijaki
- montaža v pravokotne doze velikosti 2x7M
- primeren za sestavo z okvirji 2x7M
- ustreza EN 60669-1

MOUNTING FRAME WITH SCREWS 2x7M

- mounting frame 2x7M with screws
- for mounting on rectangular boxes 2x7M
- suitable for assembling with cover plates 2x 7M
- in accordance with EN 60669-1

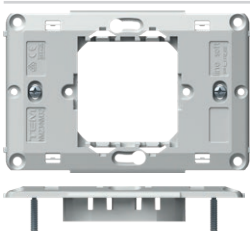
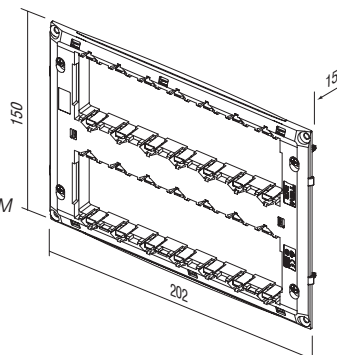

NM32

NOSILEC Z VIJAKI 2/3M

- nosilec 2/3M z vijaki
- montaža v pravokotne doze velikosti 3M
- primeren za sestavo z okvirji PURE, LINE in SOFT
- ustreza EN 60669-1

MOUNTING FRAME WITH SCREWS 2/3M

- mounting frame 2/3M with screws
- for mounting on rectangular boxes 3M
- suitable for assembling with cover plates PURE, LINE and SOFT
- in accordance with EN 60669-1

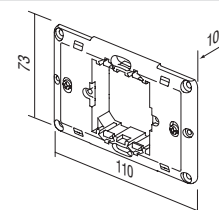





DOZE

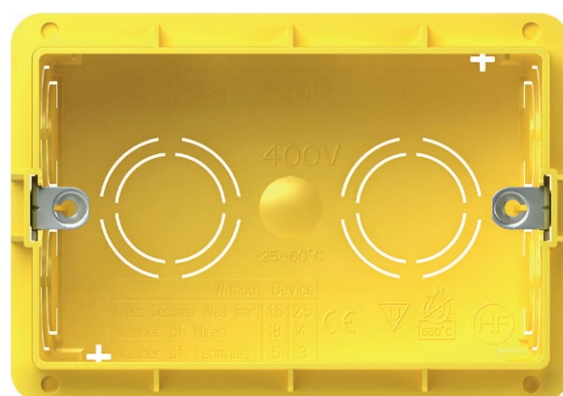

TEM



DE12



HE11



BE10

| tip type | naziv description | velikost size |
|-------------|--|------------------|
| DE10 | DOZA OKROGLA ZA ZID ROUND BOX BRICK | SM60-01 |
| HE10 | DOZA OKROGLA ZA VOTLE STENE ROUND BOX HOLLOW WALL | SM68X40 |
| BE10 | DOZA OKROGLA ZA BETON ROUND BOX CONCRETE | |
| · | · | · |
| · | · | · |

DOZA OKROGLA ZA ZID SM60-01



DE10

- Ø60, globina 40mm
- 650°C, 500V~
- ustreza IEC 60670-1
- "halogen free"
- možnost pritrditve nosilca z vijaki Ø 3 mm

ROUND BOX BRICK SM60-01

- Ø60, depth 40mm
- 650°C, 500V~
- in accordance with IEC 60670-1
- halogen free
- option of mounting the mounting frame with Ø 3 mm screws

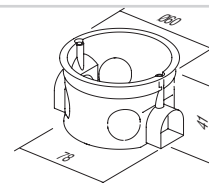

DOZA OKROGLA ZA ZID GLOBOKA SM60-06



DE11

- Ø60, globina 60mm
- 650°C, 500V~
- ustreza IEC 60670-1
- "halogen free"
- možnost pritrditve nosilca z vijaki Ø 3 mm

ROUND BOX BRICK DEEP SM60-06

- Ø60, depth 60mm
- 650°C, 500V~
- in accordance with IEC 60670-1
- halogen free
- option of mounting the mounting frame with Ø 3 mm screws

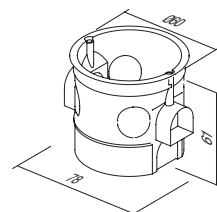

VEZNI ČLEN DOZE ZA ZID SM60-03



DE30

- za vertikalno povezavo doz SM60-06 ali SM60-01
- na razdaljo 91 mm
- ustreza IEC 60670-1
- "halogen free"

COMBI-CLIP SM60-03

- for vertical fitting of boxes SM60-06 or SM60-01 on distance 91 mm
- in accordance with IEC 60670-1
- halogen free

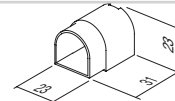

VEZNI ČLEN DOZE ZA ZID SM60-04



DE31







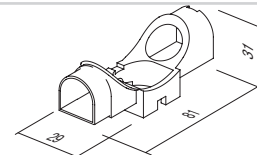



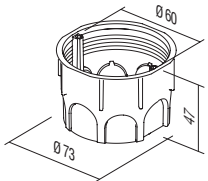

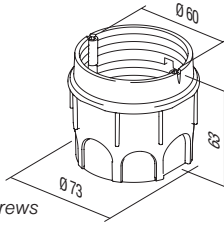

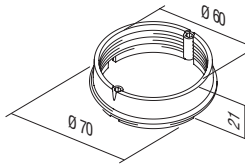
- za horizontalno povezavo doz SM60-06 ali SM60-01
- na razdaljo 71mm
- ustreza IEC 60670-1
- "halogen free"

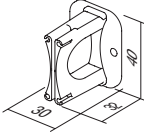
COMBI-CLIP SM60-04

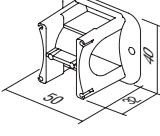
- for horizontal fitting of boxes SM60-06 or SM60-01 on distance 71mm
- in accordance with IEC 60670-1
- halogen free

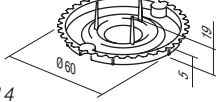

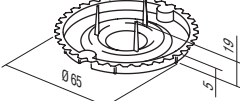
R O U N D B O X E S

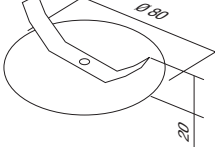
| | | | | |
|---|------|-------------------------------------|--|---|
|  | DE12 | DOZA OKROGLA ZA ZID MD65-46 | <ul style="list-style-type: none"> - Ø65, globina 46mm - 650°C, 500V~ - ustreza IEC 60670-1 - "halogen free" - možnost pritrditve nosilca z vijaki Ø 3 mm |  |
| | | ROUND BOX BRICK MD65-46 | <ul style="list-style-type: none"> - Ø65, depth 46mm - 650°C, 500V~ - in accordance with IEC 60670-1 - halogen free - option of mounting the mounting frame with Ø 3 mm screws | |
|  | DE13 | DOZA OKROGLA ZA ZID GLOBOKA MD65-60 | <ul style="list-style-type: none"> - Ø65/60, globina 62mm - 650°C, 500V~ - ustreza IEC 60670-1 - "halogen free" - možnost pritrditve nosilca z vijaki Ø 3 mm |  |
| | | ROUND BOX BRICK DEEP MD65-60 | <ul style="list-style-type: none"> - Ø65/60, depth 62mm - 650°C, 500V~ - in accordance with IEC 60670-1 - halogen free - option of mounting the mounting frame with Ø 3 mm screws | |
|  | DE14 | PODALJŠEK DOZE ZA ZID MD65-46 | <ul style="list-style-type: none"> - Ø65/60, globina 17mm - 650°C, 500V~ - ustreza IEC 60670-1 - "halogen free" |  |
| | | ADDITIONAL PIECE FOR MD65-46 | <ul style="list-style-type: none"> - Ø65/60, depth 17mm - 650°C, 500V~ - in accordance with IEC 60670-1 - halogen free | |
|  | DE32 | VEZNI ČLEN DOZE ZA ZID MD65-71 | <ul style="list-style-type: none"> - za povezavo doz MD65 na razdaljo 71 mm - ustreza IEC 60670-1 - "halogen free" |  |
| | | COMBI-CLIP MD65-71 | <ul style="list-style-type: none"> - for fitting of boxes MD65 on distance 71mm - in accordance with IEC 60670-1 - halogen free | |
|  | DE33 | VEZNI ČLEN DOZE ZA ZID MD65-91 | <ul style="list-style-type: none"> - za povezavo doz MD65 na razdaljo 91mm - ustreza IEC 60670-1 - "halogen free" |  |
| | | COMBI-CLIP MD65-91 | <ul style="list-style-type: none"> - for fitting of boxes MD65 on distance 91mm - in accordance with IEC 60670-1 - halogen free | |
|  | DE20 | POKROV DOZE ZAŠČITNI 60 | <ul style="list-style-type: none"> - zaščitni pokrov doze Ø60 za DE10, DE11, DE13, DE14 - ustreza IEC 60670-1 - za zaščito pri ometavanju |  |
| | | BOX COVER PROTECTIVE 60 | <ul style="list-style-type: none"> - protective cover for box Ø60 for DE10, DE11, DE13, DE14 - in accordance with IEC 60670-1 - box protection during plastering | |
|  | DE21 | POKROV DOZE ZAŠČITNI 65 | <ul style="list-style-type: none"> - zaščitni pokrov doze Ø65 za DE12 - ustreza IEC 60670-1 - za zaščito pri ometavanju |  |
| | | BOX COVER PROTECTIVE 65 | <ul style="list-style-type: none"> - protective cover for box Ø65 for DE12 - in accordance with IEC 60670-1 - box protection during plastering | |
|  | DE22 | POKROV DOZE DEKORATIVNI SM60 | <ul style="list-style-type: none"> - dekorativni pokrov doze Ø60 - ustreza IEC 60670-1 - "halogen free" |  |
| | | BOX COVER DECORATIVE SM60 | <ul style="list-style-type: none"> - decorative cover for boxes Ø60 - in accordance with IEC 60670-1 - halogen free | |



navodila za montažo /
assembly instructions

razdalja med dozami /
distance between boxes: 71mm

razdalja med dozami /
distance between boxes: 91mm

DE10,11

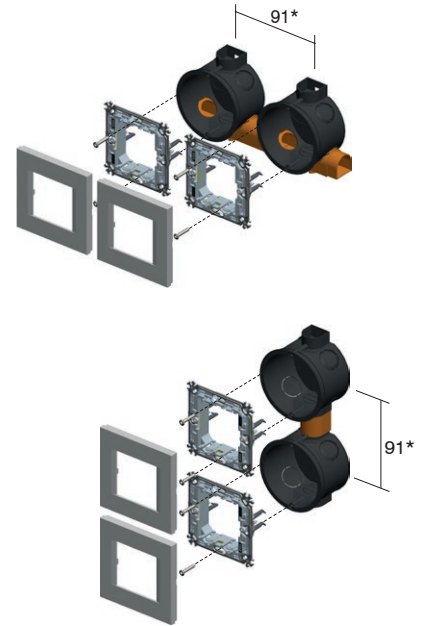
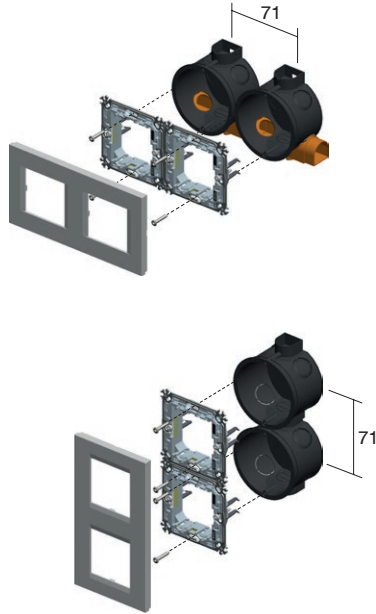
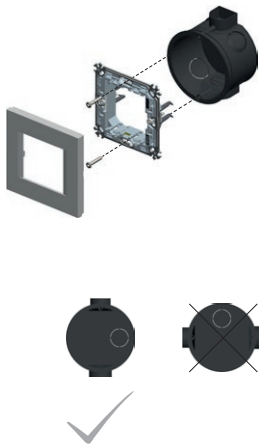

DE12,13

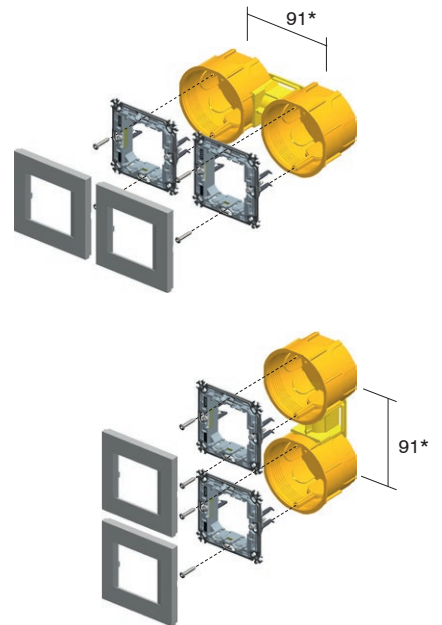
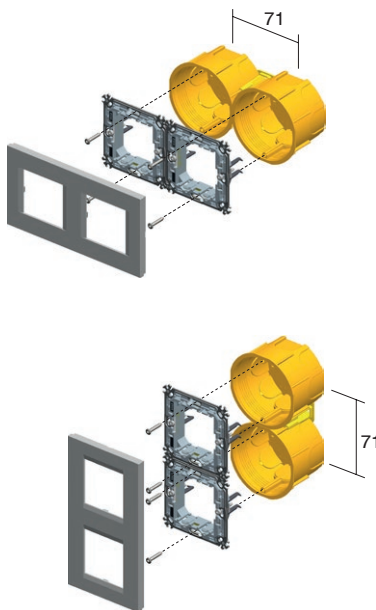
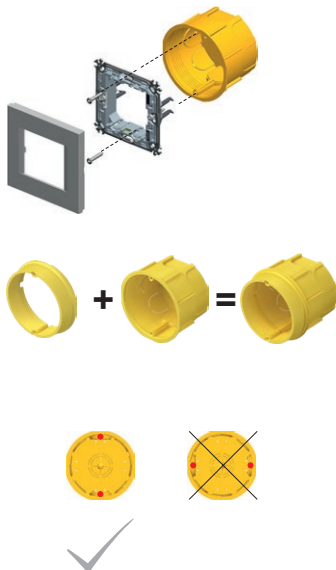

* za okvirje PURE je minimalna razdalja
med dozami 100mm

* for PURE cover plates the minimum distance between
boxes is 100mm

R O U N D B O X E S



DE10,11



DE12,13



NM20



NM24



DE10,11



DE12,13



NM10



DE10,11



DE12,13



NM23



71

2xDE10,11 + 2xDE31



2xNM20



2xDE12,13 + 1xDE32



2xNM24



2xDE10,11 2xDE12,13 + 1xDE32



2xNM20



2xNM24



3xDE10,11 + 3xDE31



3xNM20



3xDE12,13 + 2xDE32



3xNM24

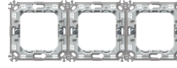

3xDE10,11 3xDE12,13 + 2xDE32



3xNM20



3xNM24

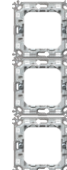

4xDE10,11 + 4xDE31



4xNM20



4xDE12,13 + 3xDE32



4xNM24



4xDE10,11 4xDE12,13 + 3xDE32

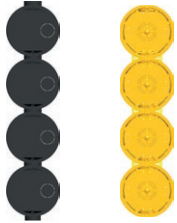

4xNM20



4xNM24



5xDE10,11

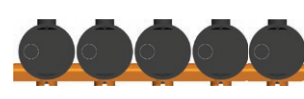

5xNM20



5xDE12,13 + 4xDE32



5xNM24

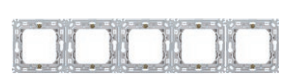

DOZA OKROGLA ZA VOTLE STENE SM68x40



HE10

- Ø60, globina 40mm
- vgradnja v izvrtino Ø68
- 850°C, 400V~
- ustreza IEC 60670-1
- montaža s krepeljci
- "halogen free"
- pritrnitev nosilca z vijaki Ø 3 mm

ROUND BOX HOLLOW WALL SM68x40

- Ø60, depth 40mm
- cutting hole Ø68
- 850°C, 400V~
- in accordance with IEC 60670-1
- mounting with claws
- halogen free
- mounting the mounting frame with Ø 3 mm screws

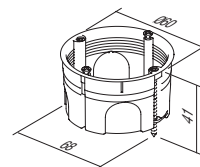

DOZA OKROGLA ZA VOTLE STENE SM68x55



HE11

- Ø60, globina 55mm
- vgradnja v izvrtino Ø68
- 850°C, 400V~
- ustreza IEC 60670-1
- montaža s krepeljci
- "halogen free"
- pritrnitev nosilca z vijaki Ø 3 mm

ROUND BOX HOLLOW WALL SM68x55

- Ø60, depth 55mm
- cutting hole Ø68
- 850°C, 400V~
- in accordance with IEC 60670-1
- mounting with claws
- halogen free
- mounting the mounting frame with Ø 3 mm screws

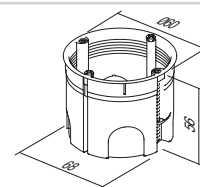

DOZA OKROGLA ZA BETON



BE10

- Ø60mm, globina 49mm
- 650°C, 500V~
- ustreza IEC 60670-1
- "halogen free"
- pritrnitev nosilca z vijaki Ø 3 mm

ROUND BOX CONCRETE

- Ø60mm, depth 49mm
- 650°C, 500V~
- in accordance with IEC 60670-1
- halogen free
- mounting the mounting frame with Ø 3 mm screws

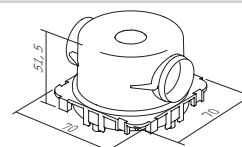

DOZA OKROGLA ZA BETON GLOBOKA



BE11

- Ø60mm, globina 58mm
- 650°C, 500V~
- ustreza IEC 60670-1
- "halogen free"
- pritrnitev nosilca z vijaki Ø 3 mm

ROUND BOX CONCRETE DEEP

- Ø60mm, depth 58mm
- 650°C, 500V~
- in accordance with IEC 60670-1
- halogen free
- mounting the mounting frame with Ø 3 mm screws

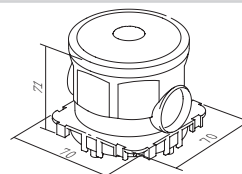

NOSILEC DOZE ZA BETON



BE20

- za utrditev doze z distančnim profilom BM82 v nasprotno steno
- ustreza IEC 60670-1
- "halogen free"

COUNTER BOX SUPPORT CONCRETE

- to support concrete boxes with discance profile BM82 for extreme loads
- in accordance with IEC 60670-1
- halogen free

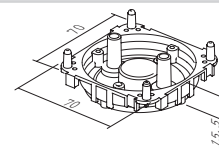

UVODNICA DOZE ZA BETON 16



BE21

- za utrditev instalacijske cevi
- ustreza IEC 60670-1
- "halogen free"

PIPE STOPPER CONCRETE BOX 16

- for firming installation pipe to box
- in accordance with IEC 60670-1
- halogen free

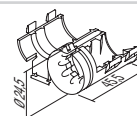

R O U N D

B O X E S

votle stene / hollow walls



beton / concrete



navodila za montažo /
assembly instructions

razdalja med dozami /
distance between boxes: 71mm

razdalja med dozami /
distance between boxes: 91mm

HE10,11

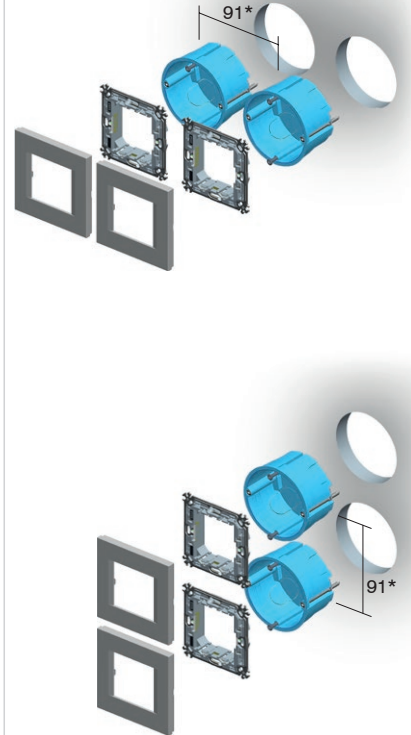
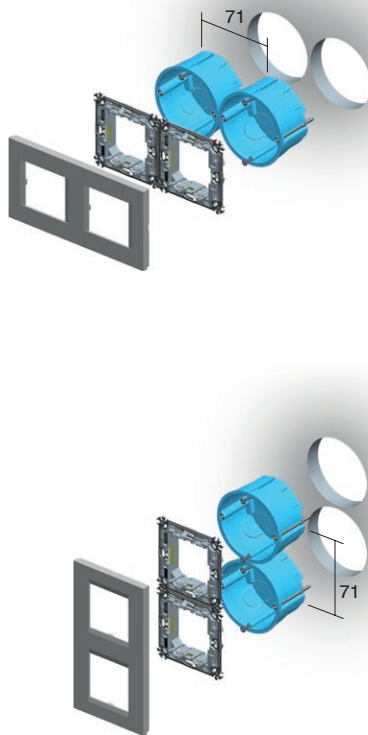
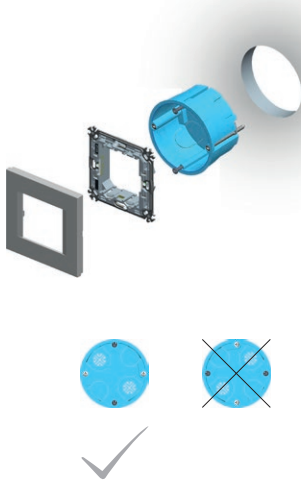

BE10

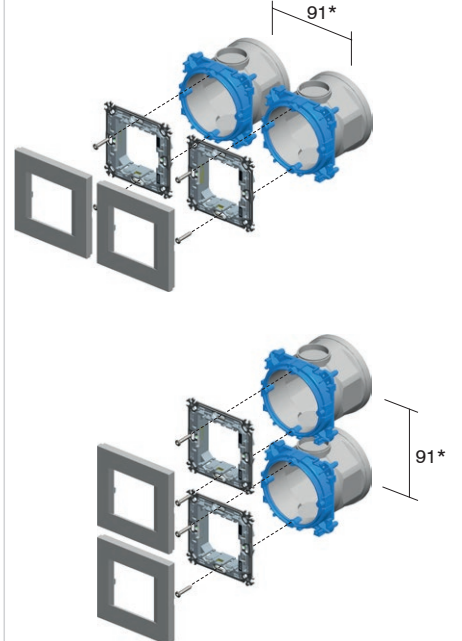
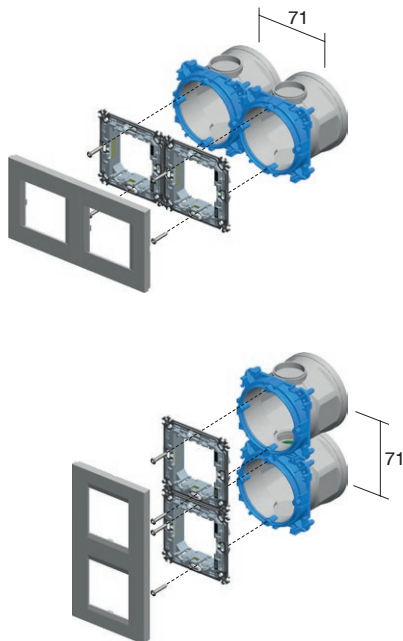
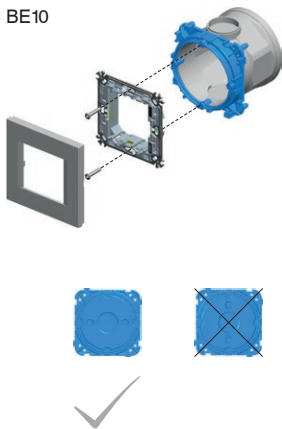

* za okvirje PURE je min. razdalja me dozami 100mm

* for PURE cover plates the minimum distance between boxes is 100mm

votle stene / hollow walls



beton / concrete



HE10,11



BE10,11



NM21



NM25



2M

HE10,11



BE10,11



NM11



1/2M

2xHE10,11



2xBE10,11



2xNM21



2xNM25



2x2M

HE10,11



BE10,11



NM32



2/3M

2xHE10,11



2xBE10,11



2xNM21



2xNM25



5xHE10,11



5xNM21



5xBE10,11



5xNM25



5x2M

3xHE10,11



3xBE10,11



3xNM21



3xNM25



3x2M

3xHE10,11



3xBE10,11



3xNM21



3xNM25



4xHE10,11



4xBE10,11



4xNM21



4xNM25



4x2M

4xHE10,11



4xBE10,11



4xNM21



4xNM25



R O U N D B O X E S

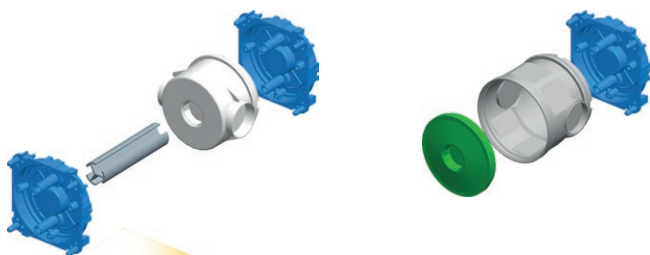

navodila za montažo /
assembly instructions

1

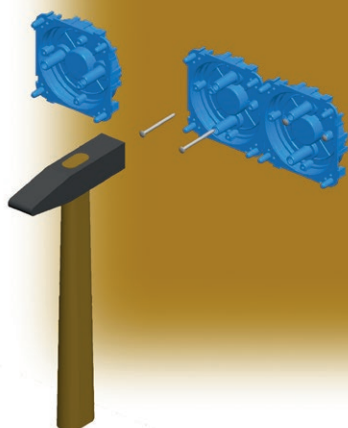

2

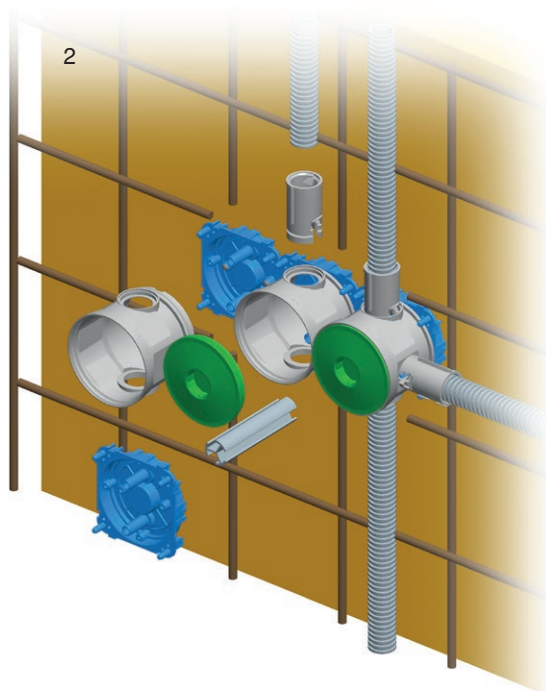

3

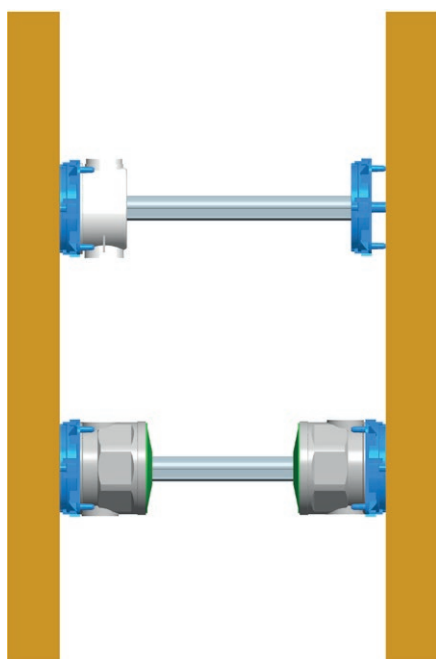

4

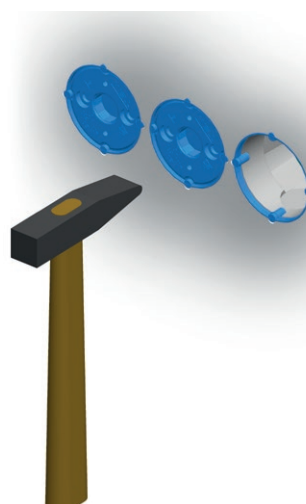



DM30



HM30



BM30

| tip type | naziv description | velikost size |
|-------------|---|------------------|
| DM30 | DOZA PRAVOKOTNA ZA ZID RECTANGULAR BOX BRICK | PM3 |
| HM30 | DOZA PRAVOKOTNA ZA VOTLE STENE RECTANGULAR BOX HOLLOW WALL | VM3 |
| BM30 | DOZA PRAVOKOTNA ZA BETON RECTANGULAR BOX CONCRETE | BM3 |
| · | · | · |
| · | · | · |

DOZA PRAVOKOTNA ZA ZID PM3



DM30

- velikost 3M, globina 49mm
- 650°C, 400V~
- ustreza IEC 60670-1
- "halogen free"

RECTANGULAR BOX BRICK PM3

- size 3M, depth 49mm
- 650°C, 400V~
- in accordance with IEC 60670-1
- halogen free

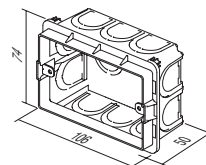

DOZA PRAVOKOTNA ZA ZID PM3-65



DM31

- velikost 3M, globina 65mm
- 650°C, 400V~
- ustreza IEC 60670-1
- "halogen free"

RECTANGULAR BOX BRICK PM3-65

- size 3M, depth 65mm
- 650°C, 400V~
- in accordance with IEC 60670-1
- halogen free

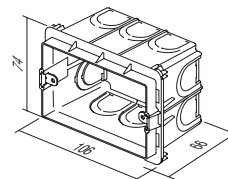

DOZA PRAVOKOTNA ZA ZID PM4



DM40

- velikosti 4M, globina 49mm
- 650°C, 400V~
- ustreza IEC 60670-1
- "halogen free"

RECTANGULAR BOX BRICK PM4

- size 4M, depth 49mm
- 650°C, 400V~
- in accordance with IEC 60670-1
- halogen free

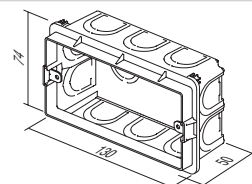

DOZA PRAVOKOTNA ZA ZID PM4-65



DM41

- velikosti 4M, globina 65mm
- 650°C, 400V~
- ustreza IEC 60670-1
- "halogen free"

RECTANGULAR BOX BRICK PM4-65

- size 4M, depth 65mm
- 650°C, 400V~
- in accordance with IEC 60670-1
- halogen free

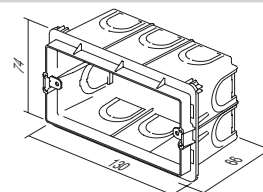

R E C T A N G U L A R B O X E S

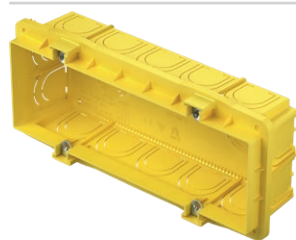

DM70

DOZA PRAVOKOTNA ZA ZID PM7

- velikost 7M, globina 49mm
- 650 °C, 400V~
- ustreza IEC 60670-1
- "halogen free"

RECTANGULAR BOX BRICK PM7

- size 7M, depth 49mm
- 650 °C, 400V~
- in accordance with IEC 60670-1
- halogen free

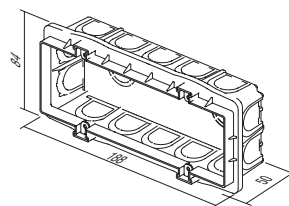

DM71

DOZA PRAVOKOTNA ZA ZID PM7-65

- velikost 7M, globina 65mm
- 650 °C, 400V~
- ustreza IEC 60670-1
- "halogen free"

RECTANGULAR BOX BRICK PM7-65

- size 7M, depth 65mm
- 650 °C, 400V~
- in accordance with IEC 60670-1
- halogen free

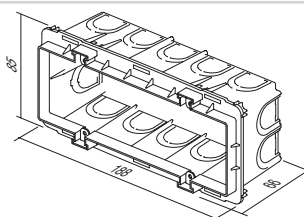

DM72

DOZA PRAVOKOTNA ZA ZID PM72-65

- velikost 2x7M, globina 64mm
- 650 °C, 400V~
- ustreza IEC 60670-1
- "halogen free"

RECTANGULAR BOX BRICK PM72-65

- size 2x7M, depth 64mm
- 650 °C, 400V~
- in accordance with IEC 60670-1
- halogen free

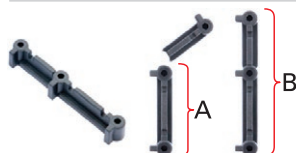
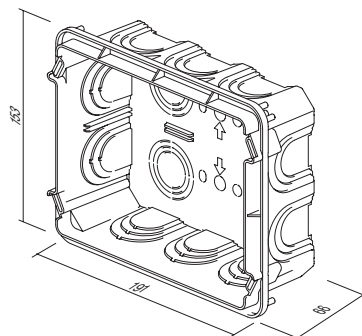

DM80

VEZNI ČLEN DOZE PM

- za vertikalno (A) in horizontalno (B) sestavo doz PM3, PM4 in PM7
- primeren za dekorativne okvirje Line in Soft (za PURE ni primeren)

DISTANCE PIECE FOR BOX PM

- for vertical (A) and horizontal (B) fitting of boxes PM3, PM4 and PM7
- suitable for Line and Soft decorative cover plates (not for PURE)

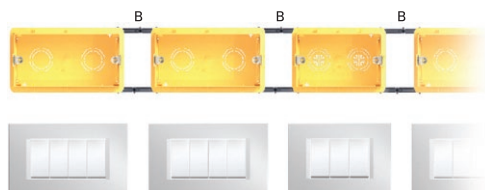
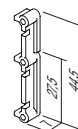

POKROV DOZE ZAŠČITNI PM3



DM33

- zaščitni pokrov doze PM3
- ustreza IEC 60670-1
- "halogen free"
- za zaščito pri ometavanju

BOX COVER PROTECTIVE PM3

- protective cover for box PM3
- in accordance with IEC 60670-1
- halogen free
- box protection during plastering

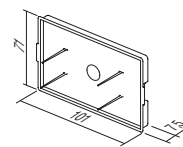

POKROV DOZE DEKORATIVNI PM3



DM34

- dekorativni pokrov doze 3M
- vijaka priložena
- ustreza IEC 60670-1
- "halogen free"

BOX COVER DECORATIVE PM3

- decorative cover for boxes 3M
- screws are included
- in accordance with IEC 60670-1
- halogen free

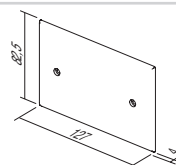

POKROV DOZE ZAŠČITNI PM4



DM43

- zaščitni pokrov doze PM4
- ustreza IEC 60670-1
- "halogen free"
- za zaščito pri ometavanju

BOX COVER PROTECTIVE PM4

- protective cover for box PM4
- in accordance with IEC 60670-1
- halogen free
- box protection during plastering

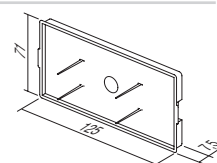

POKROV DOZE DEKORATIVNI PM4



DM44

- dekorativni pokrov doze 4M
- vijaka priložena
- ustreza IEC 60670-1
- "halogen free"

BOX COVER DECORATIVE PM4

- decorative cover for boxes 4M
- screws are included
- in accordance with IEC 60670-1
- halogen free

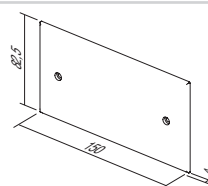

POKROV DOZE ZAŠČITNI PM7

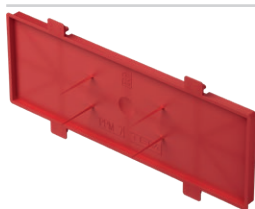

DM73

- zaščitni pokrov doze PM7
- ustreza IEC 60670-1
- "halogen free"
- za zaščito pri ometavanju

BOX COVER PROTECTIVE PM7

- protective cover for box PM7
- in accordance with IEC 60670-1
- halogen free
- box protection during plastering

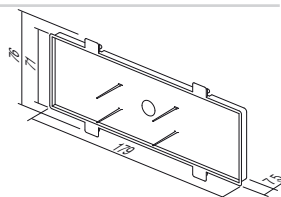

POKROV DOZE DEKORATIVNI PM7



DM74

- dekorativni pokrov doze 7M
- vijaka priložena
- ustreza IEC 60670-1
- "halogen free"

BOX COVER DECORATIVE PM7

- decorative cover for boxes 7M
- screws are included
- in accordance with IEC 60670-1
- halogen free

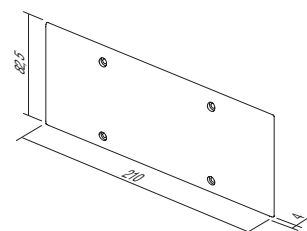

R E C T A N G U L A R B O X E S



DM75

POKROV DOZE DEKORATIVNI PM72

- dekorativni pokrov doze 2x7M
- vijaki priloženi
- ustreza IEC 60670-1

BOX COVER DECORATIVE PM72
- decorative cover for boxes 2x7M
- screws are included
- in accordance with IEC 60670-1

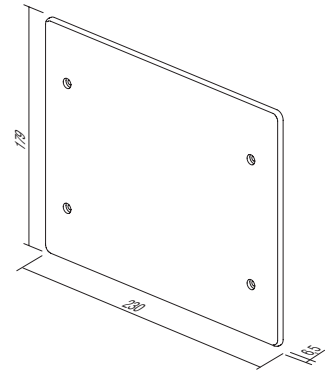

DOZA PRAVOKOTNA ZA VOTLE STENE VM3



HM30

- velikost 3M, globina 49mm
- vgradnja v izvrtino 2xØ68/45mm
- 850°C, 400V~
- ustreza IEC 60670-1
- "halogen free"

RECTANGULAR BOX HOLLOW WALL VM3

- size 3M, depth 49mm
- cutting hole 2xØ68/45mm
- 850°C, 400V~
- in accordance with IEC 60670-1
- halogen free

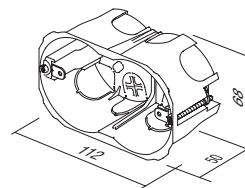

DOZA PRAVOKOTNA ZA VOTLE STENE VM4



HM40

- velikost 4M, globina 49mm
- vgradnja v izvrtino 2xØ68/70mm
- 850°C, 400V~
- ustreza IEC 60670-1
- "halogen free"

RECTANGULAR BOX HOLLOW WALL VM4

- size 4M, depth 49mm
- cutting hole 2xØ68/70mm
- 850°C, 400V~
- in accordance with IEC 60670-1
- halogen free

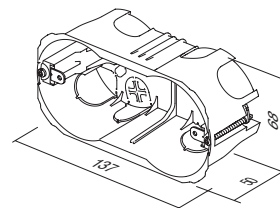

DOZA PRAVOKOTNA ZA VOTLE STENE VM7



HM70

- velikost 7M, globina 49mm
- vgradnja v izvrtino 2xØ68/120mm
- 850°C, 400V~
- ustreza IEC 60670-1
- "halogen free"

RECTANGULAR BOX HOLLOW WALL VM7

- size 7M, depth 49mm
- cutting hole 2xØ68/120mm
- 850°C, 400V~
- in accordance with IEC 60670-1
- halogen free

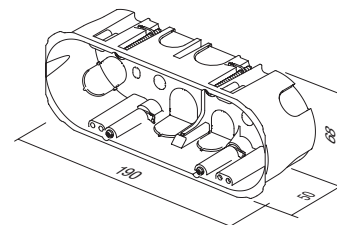

DOZA PRAVOKOTNA ZA VOTLE STENE VM72



HM72







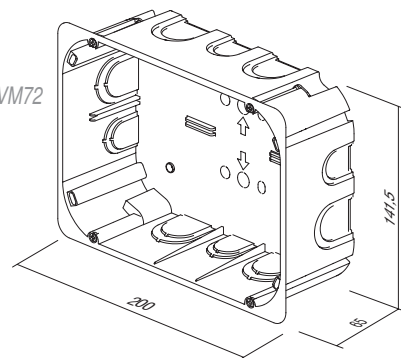

- velikost 2x7M, globina 63mm
- 850°C, 400V~
- ustreza IEC 60670-1
- "halogen free"

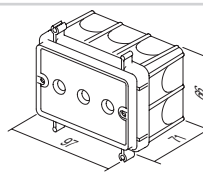
RECTANGULAR BOX HOLLOW WALL VM72

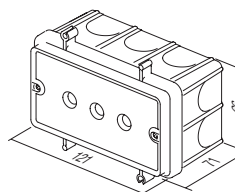
- size 2x7M, depth 63mm
- 850°C, 400V~
- in accordance with IEC 60670-1
- halogen free

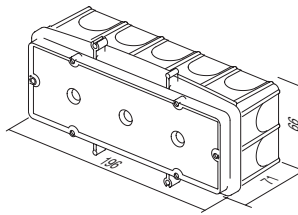

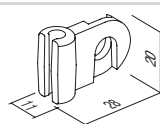
R E C T A N G U L A R B O X E S

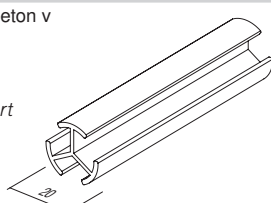
| | | | |
|---|------|---|---|
|  | BM30 | DOZA PRAVOKOTNA ZA BETON BM3 - velikost 3M, globina 60mm - 650°C, 400V~ - ustreza IEC 60670-1 - "halogen free" |  |
|  | BM40 | DOZA PRAVOKOTNA ZA BETON BM4 - velikost 4M, globina 60mm - 650°C, 400V~ - ustreza IEC 60670-1 - "halogen free" |  |
|  | BM70 | DOZA PRAVOKOTNA ZA BETON BM7 - velikost 7M, globina 60mm - 650°C, 400V~ - ustreza IEC 60670-1 - "halogen free" |  |
|  | BM80 | PRITRDLJNI ČLEN DOZ BM - za hitro pritrnitev pravokotnih doz BM na armaturno mrežo - primerno za palice do premera Ø8mm |  |
|  | BM82 | DISTANČNI PROFIL ZA DOZE - za utrditev doz BM skupaj z nosilcem doze za beton v nasprotno steno - dolžina l=1m, premer Ø20mm |  |

RECTANGULAR BOX CONCRETE BM3

- size 3M, depth 60mm
- 650°C, 400V~
- in accordance with IEC 60670-1
- halogen free

RECTANGULAR BOX CONCRETE BM4

- size 4M, depth 60mm
- 650°C, 400V~
- in accordance with IEC 60670-1
- halogen free

RECTANGULAR BOX CONCRETE BM7

- size 7M, depth 60mm
- 650°C, 400V~
- in accordance with IEC 60670-1
- halogen free

FIXING COMBI-CLIP BM

- for fast fixation of BM rectangular boxes on reinforcing bar
- suitable for bar diameter up to Ø8mm

DISTANCE PROFIL FOR BOXES BM

- to support boxes BM with counter box support on opposite wall
- length l=1m, diameter Ø20mm

P R A V O K O T N E D O Z E



opeka / brick

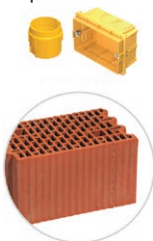

votle stene / hollow walls

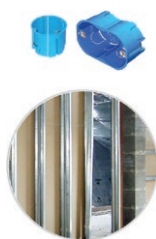

beton / concrete

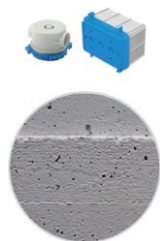

| | | | |
|------|--|------|------|
| DM30 | | NM30 | 3M |
| HM30 | | | |
| BM30 | | | |
| DM40 | | NM40 | 4M |
| HM40 | | | |
| BM40 | | | |
| DM70 | | NM70 | 7M |
| HM70 | | | |
| BM70 | | | |
| DM72 | | NM72 | 2x7M |
| HM72 | | | |
| DM30 | | NM32 | 2/3M |
| HM30 | | | |
| BM30 | | | |

R E C T A N G U L A R B O X E S

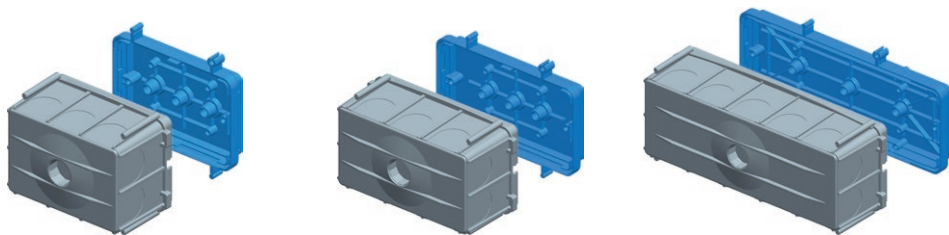

navodila za montažo /
assembly instructions

1

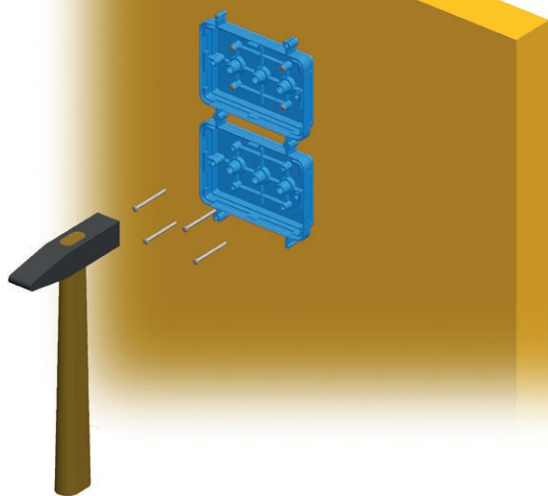

2

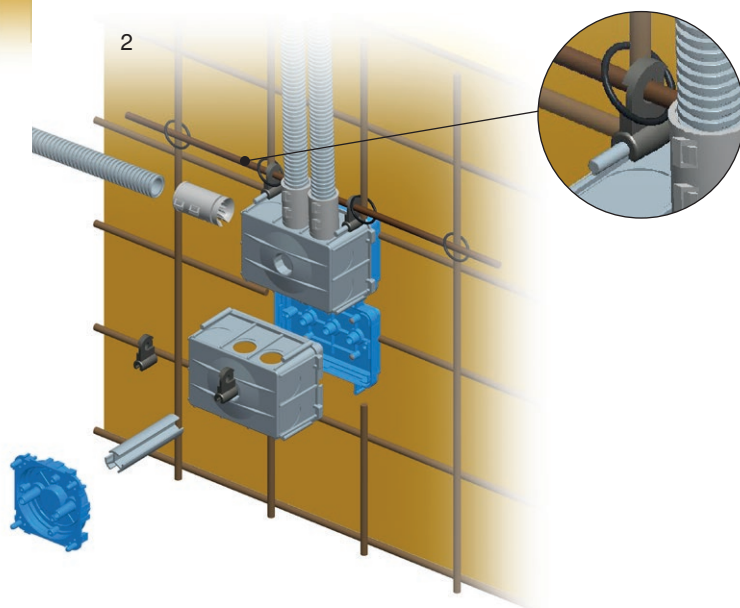

3

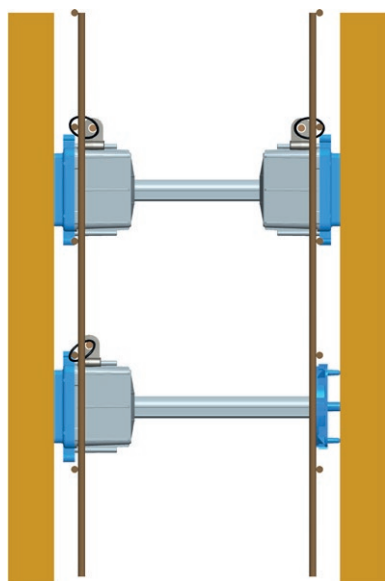

4

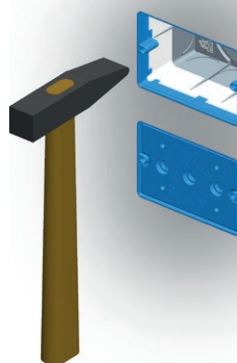

RAZVODNA DOZA OKROGLA ZA ZID DSM78



DW10

- Ø78, globina 40mm
- 650°C, 500V~
- ustreza IEC 60670-1 in IEC 60670-22
- "halogen free"

CONNECTION ROUND BOX BRICK DSM78

- Ø78, depth 40mm
- 650°C, 500V~
- in accordance with IEC 60670-1 and IEC 60670-22
- halogen free

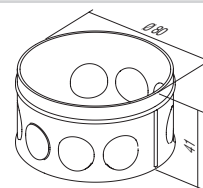

RAZVODNA DOZA OKROGLA ZA VOTLE STENE SM78x45



HW10

- Ø78, globina 45mm
- vgradnja v izvrtino Ø80
- 850°C, 400V~
- ustreza IEC 60670-1 in IEC 60670-22
- montaža s krepeljci
- "halogen free"

CONNECTION ROUND BOX HOLLOW WALL SM78x45

- Ø78, depth 45mm
- cutting hole Ø80
- 850°C, 400V~
- in accordance with IEC 60670-1 and IEC 60670-22
- mounting with claws
- halogen free

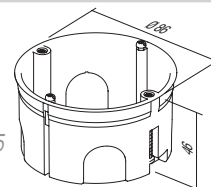

POKROV DOZE DEKORATIVNI SM78



DE23

- dekorativni pokrov doze Ø78
- ustreza IEC 60670-1 and IEC 60670-22
- "halogen free"

BOX COVER DECORATIVE SM78

- decorative cover for boxes Ø78
- in accordance with IEC 60670-1 and IEC 60670-22
- halogen free

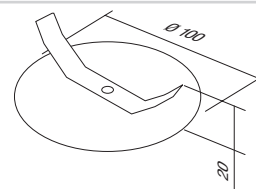

POKROV DOZE ZAŠČITNI 78



DE24

- zaščitni pokrov doze Ø78
- ustreza IEC 60670-1 in IEC 60670-22
- "halogen free"

BOX COVER PROTECTIVE 78

- protective cover for box Ø78
- in accordance with IEC 60670-1 and IEC 60670-22
- halogen free

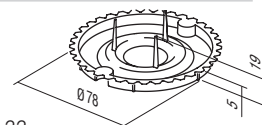

RAZVODNA DOZA KVADRATNA ZA ZID SM105x105



HW20

- 105x105mm, globina 50mm
- vgradnja v izvrtino s priloženo šablono
- 850°C, 400V~
- ustreza IEC 60670-1 in IEC 60670-22
- montaža s krepeljci
- "halogen free"

CONNECTION SQUARE BOX BRICK SM105x105

- size 105x105mm, depth 50mm
- cutting hole according to attached template
- 850°C, 400V~
- in accordance with IEC 60670-1 and IEC 60670-22
- mounting with claws
- halogen free

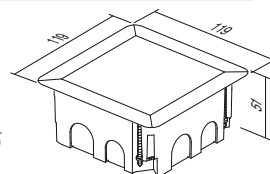

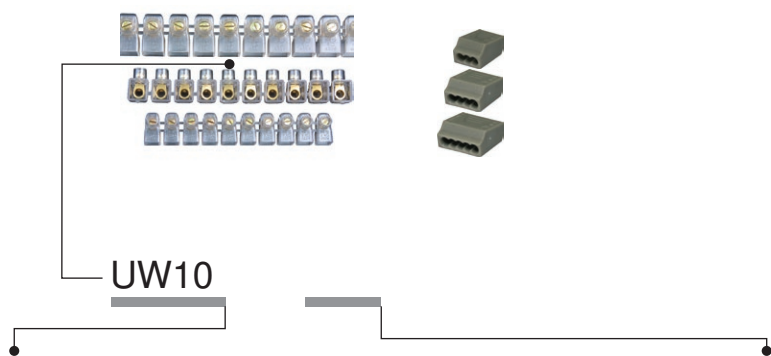

| tip type | naziv description | tehnični opis technical data | velikost size | barva colour |
|-------------|---|---------------------------------|------------------|--|
| UW10 | ENOREDNE SPONKE ZAPRTE 1 ROW TERMINAL BLOCKS | 2x2.5mm ² | 10P | <input checked="" type="checkbox"/> TS prozorna transparent |
| UW11 | ENOREDNE SPONKE ZAPRTE 1 ROW TERMINAL BLOCKS | 2x4mm ² | 10P | <input checked="" type="checkbox"/> CO barvne colour |
| UW12 | ENOREDNE SPONKE ZAPRTE 1 ROW TERMINAL BLOCKS | 2x6mm ² | 10P | <input type="checkbox"/> WH bela white |
| ⋮ | ⋮ | ⋮ | ⋮ | <input type="checkbox"/> GY siva grey |

ENOREDNE SPONKE ZAPRTE



- 450V~; 2x2.5mm² ÷ 2x6mm²
- termoplast PC, prozorne
- število polov: 10

1 ROW TERMINAL BLOCKS CLOSED

- 450V~; 2x2.5mm² ÷ 2x6mm²
- thermoplast PC, transparent
- number of poles: 10

| | | | |
|--------|--------|----------------------|-----|
| UW10TS | (NS12) | 2x2.5mm ² | 10P |
| UW11TS | (NS12) | 2x4mm ² | 10P |
| UW12TS | (NS12) | 2x6mm ² | 10P |

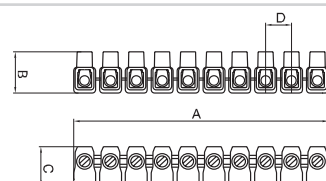

| | A | B | C | D |
|---------|-----|------|------|------|
| 2x2.5 □ | 110 | 17.5 | 17.5 | 11 |
| 2x4 □ | 128 | 21 | 19 | 12.5 |
| 2x6 □ | 146 | 21.5 | 22 | 15 |

ENOREDNE SPONKE

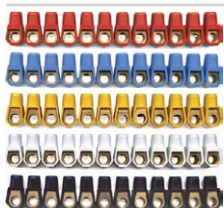

- 450V~; 2x2.5mm² ÷ 2x6mm²
- termoplast PA
- na voljo v različnih barvah
- število polov: 12

1 ROW TERMINAL BLOCKS

- 450V~; 2x2.5mm² ÷ 2x6mm²
- thermoplast PA
- available in different colours
- number of poles: 12

| | | | |
|--------|--------|----------------------|-----|
| UW15CO | (NS12) | 2x2.5mm ² | 12P |
| UW16CO | (NS12) | 2x4mm ² | 12P |
| UW17CO | (NS12) | 2x6mm ² | 12P |

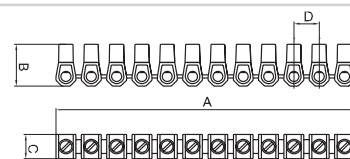

| | A | B | C | D |
|---------|-------|------|----|------|
| 2x2.5 □ | 110 | 16.4 | 9 | 10 |
| 2x4 □ | 118.8 | 19 | 10 | 10 |
| 2x6 □ | 129.8 | 21.3 | 11 | 11.8 |

DVOREDNE SPONKE PP

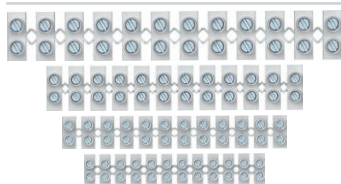

- 450 V~; 1 mm² ÷ 16 mm²
- termoplast polipropilen PP, bele
- za uporabo do 80°C
- število polov: 12

2 ROW TERMINAL BLOCKS PP

- 450V~; 1mm² ÷ 16mm²
- thermoplast polypropylene PP, white
- for temperatures up to 80°C
- number of poles: 12

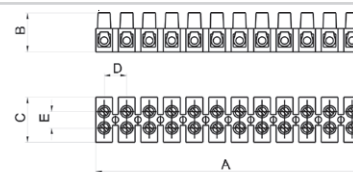

| | | | | | A | B | C | D | E |
|----------|------------------------|------|-------|--|-------|------|------|------|-----|
| UW29WHPP | 1.0-4.0mm ² | 24 A | 450 V | | 94,9 | 13 | 16,6 | 8,1 | 6,4 |
| UW30WHPP | 1.5-6.0mm ² | 32 A | 450 V | | 116,5 | 14,9 | 18,9 | 10 | 7,3 |
| UW31WHPP | 2.5-10mm ² | 41 A | 450 V | | 133,8 | 17,3 | 23,4 | 11,5 | 10 |
| UW32WHPP | 4-16mm ² | 76 A | 450 V | | 174,5 | 20,7 | 25 | 15 | 11 |

W I R I N G A C C E S S O R I E S

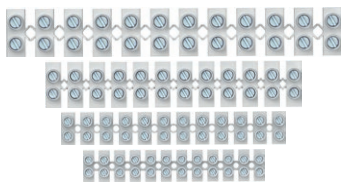

DVOREDNE SPONKE PA

- 450 V~; 1 mm² ÷ 16 mm²
- termoplast poliamid PA, bele
- za uporabo do 110°C
- število polov: 12

2 ROW TERMINAL BLOCKS PA

- 450V~; 1mm² ÷ 16mm²
- thermoplast polyamide PA, white
- for temperatures up to 110°C
- number of poles: 12

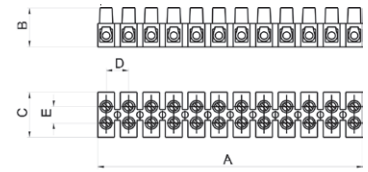

| | | | | | A | B | C | D | E |
|----------|------------------------|------|-------|--|-------|------|------|------|-----|
| UW25WHPA | 1.0-4.0mm ² | 24 A | 450 V | | 93,6 | 13,4 | 16,2 | 8 | 6,4 |
| UW26WHPA | 1.5-6.0mm ² | 32 A | 450 V | | 117 | 15 | 18,6 | 10 | 7,3 |
| UW27WHPA | 2.5-10mm ² | 41 A | 450 V | | 132,8 | 17,3 | 22,2 | 11,5 | 10 |
| UW28WHPA | 4-16mm ² | 76 A | 450 V | | 173,9 | 20,8 | 25,2 | 15 | 11 |

BREZVIJAČNE SPONKE



- 24A 450V~, termoplast PA, sive
- število polov: 3÷8
- brezvijačni kontakti 0.5 ÷ 1.5mm², za trde žice
- ustreza EN 60998-1

PLUG-IN WIRE CONNECTORS

- 24A 450V~, thermoplast PA, grey
- number of poles: 3÷8
- plug-in contacts 0.5÷1.5mm², for rigide wires
- in accordance with EN 60998-1

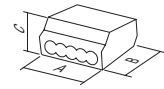

| | | | | | A | B | C |
|--------|-------|--------------------|----|----|----|----|---|
| UW40GY | PC153 | 1.5mm ² | 3P | 3P | 12 | 18 | 9 |
| UW41GY | PC155 | 1.5mm ² | 5P | 5P | 17 | 18 | 9 |
| UW42GY | PC158 | 1.5mm ² | 8P | 8P | 26 | 18 | 9 |

BREZVIJAČNE SPONKE



- 24A 450V~, termoplast PA, sive
- število polov: 3÷5
- brezvijačni kontakti 1.5 ÷ 2.5mm², za trde žice
- ustreza EN 60998-1

PLUG-IN WIRE CONNECTORS

- 24A 450V~, thermoplast PA, grey
- number of poles: 3÷5
- plug-in contacts 1.5÷2.5mm², for rigide wires
- in accordance with EN 60998-1

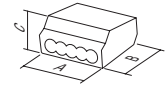

| | | | | | A | B | C |
|--------|-------|--------------------|----|----|----|----|---|
| UW45GY | PC253 | 2.5mm ² | 3P | 3P | 14 | 19 | 9 |
| UW46GY | PC254 | 2.5mm ² | 4P | 4P | 17 | 19 | 9 |
| UW47GY | PC255 | 2.5mm ² | 5P | 5P | 21 | 19 | 9 |

BREZVIJAČNE SPONKE



- 24A 450V~, termoplast PA, sive
- število polov: 2 (trda žica)+1 (mehka žica)
- brezvijačni kontakti 1.5 ÷ 2.5mm²
- ustreza EN 60998-1

PLUG-IN WIRE CONNECTOR

- 24A 450V~, thermoplast PA, grey
- number of poles: 2 (rigide wire)+1 (soft wire)
- plug-in contacts 1.5÷2.5mm²
- in accordance with EN 60998-1

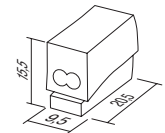

| | | | | | | | |
|--------|-------|--------------------|------|--|--|--|--|
| UW50WH | PC302 | 2.5mm ² | 2/1P | | | | |
|--------|-------|--------------------|------|--|--|--|--|



148



149



151

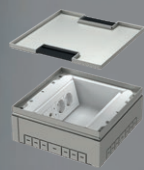

156

DISTRIBUCIJA



TEM



O H I Š J A C U B O I P 2 0 A C

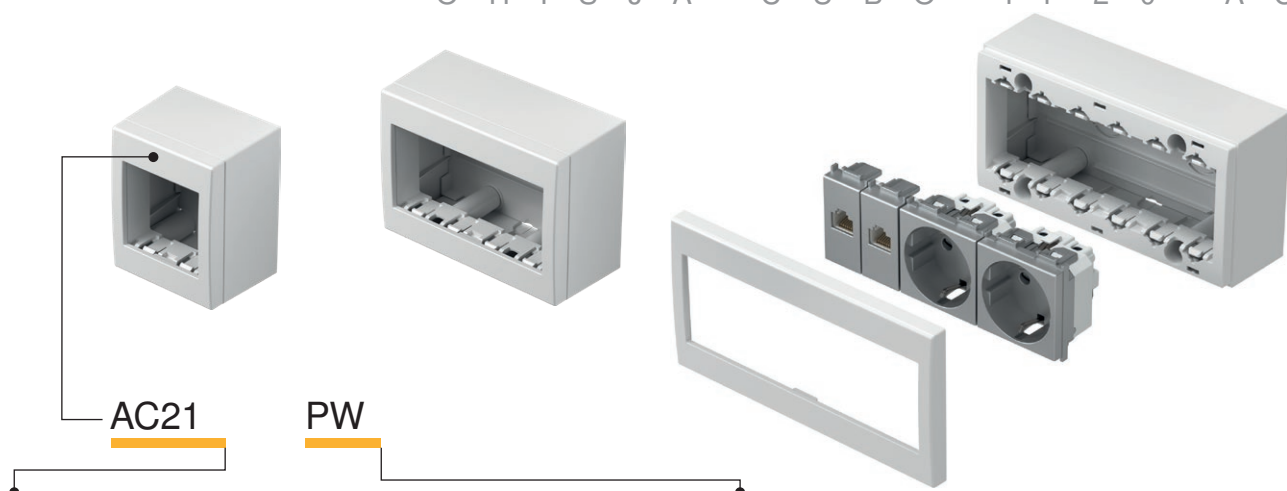

| tip type | naziv description | tehnični opis technical data | velikost size | barva colour |
|-------------|---|---------------------------------|------------------|---|
| AC11 | OHIŠJE NO CUBO Z DNOM SURFACE MOUNT BOX WITH BACK SIDE COVER | IP20 | 1M | <input type="checkbox"/> PW bela-sijaj polar white <input type="checkbox"/> ES srebrna-mat elox silver |
| AC21 | OHIŠJE NO CUBO Z DNOM SURFACE MOUNT BOX WITH BACK SIDE COVER | IP20 | 2M | <input type="checkbox"/> IW bež-sijaj ivory white |
| AC41 | OHIŠJE NO CUBO Z DNOM SURFACE MOUNT BOX WITH BACK SIDE COVER | IP20 | 4M | |

OHIŠJE NO CUBO Z DNOM IP20 1M



- AC11PW
- AC11ES
- AC11IW

- ohišje IP20 1M
- za nadometno pritrditev elementov
- primeren za stikala SM
- ustreza EN 60669-1



- BOX NO CUBO WITH BACK SIDE COVER IP20 1M*
- box IP20 1M
- for surface mounting of elements
- suitable to SM switches
- in accordance with EN 60669-1

OHIŠJE NO CUBO Z DNOM IP20 2M



- AC21PW
- AC21ES
- AC21IW

- ohišje IP20 2M
- za nadometno pritrditev elementov
- ustreza EN 60669-1, EN60884-1



- BOX NO CUBO WITH BACK SIDE COVER IP20 2M*
- box IP20 2M
- for surface mounting of elements
- in accordance with EN 60669-1, EN60884-1

OHIŠJE NO CUBO Z DNOM IP20 4M



- AC41PW
- AC41ES
- AC41IW

- ohišje IP20 4M
- za nadometno pritrditev elementov
- ustreza EN 60669-1, EN60884-1



- BOX NO CUBO WITH BACK SIDE COVER IP20 4M*
- box IP20 4M
- for surface mounting of elements
- in accordance with EN 60669-1, EN60884-1

OHIŠJE NO CUBO Z DNOM IP20 6M



- AC61PW
- AC61ES
- AC61IW

- ohišje IP20 6M
- za nadometno pritrditev elementov
- ustreza EN 60669-1, EN60884-1



- BOX NO CUBO WITH BACK SIDE COVER IP20 6M*
- box IP20 6M
- for surface mounting of elements
- in accordance with EN 60669-1, EN60884-1

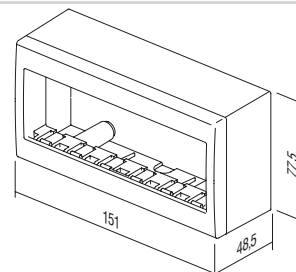
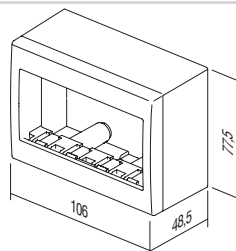
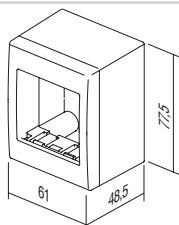
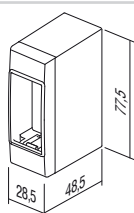

B O X E S C U B O I P 5 5 A Q



| tip type | naziv description | tehnični opis technical data | velikost size | barva colour |
|-------------|---|---------------------------------|------------------|---|
| AQ20 | OHIŠJE NO CUBO OUTDOOR SURFACE MOUNT BOX | IP55 | 2M | <input type="checkbox"/> PW bela sijaj polar white |
| AQ22 | OHIŠJE NO CUBO OUTDOOR SURFACE MOUNT BOX | IP55 | 2x2M | <input checked="" type="checkbox"/> GY siva grey |
| AQ30 | OHIŠJE NO CUBO OUTDOOR SURFACE MOUNT BOX | IP55 | 3M | |
| AQ31 | OHIŠJE PO CUBO OUTDOOR SURFACE MOUNT BOX | IP55 | 3M | |

OHIŠJE NO CUBO IP55 2M



- AQ20PW
 AQ20GY

- ohišje IP55 2M
- za nadometno pritrditev
- IP55 za vgradnjo v vlažne prostore
- ustreza CEI 23-48, EN 60670

BOX NO CUBO IP55 2M
- box IP55 2M
- for surface mounting
- IP55 for usage in humid areas
- in accordance with CEI 23-48, EN 60670



OHIŠJE NO CUBO IP55 2x2M



- AQ22PW
 AQ22GY

- ohišje IP55 2x2M
- za nadometno pritrditev
- IP55 za vgradnjo v vlažne prostore
- ustreza CEI 23-48, EN 60670

BOX NO CUBO IP55 2x2M
- box IP55 2x2M
- for surface mounting
- IP55 for usage in humid areas
- in accordance with CEI 23-48, EN 60670



OHIŠJE NO CUBO IP55 3M



- AQ30PW
 AQ30GY

- ohišje IP55 3M
- za nadometno pritrditev
- IP55 za vgradnjo v vlažne prostore
- ustreza CEI 23-48, EN 60670

BOX NO CUBO IP55 3M
- box IP55 3M
- for surface mounting
- IP55 for usage in humid areas
- in accordance with CEI 23-48, EN 60670





- AQ21PW
- AQ21AT

OHIŠJE PO CUBO IP55 2M

- ohišje IP55 2M
- lahko se kombinira z vsemi funkcijskimi elementi Modul
- za podometno pritrditev
- IP55 za vgradnjo v vlažne prostore
- ustreza CEI 23-48, EN 60670

BOX PO CUBO IP55 2M

- box IP55 2M
- can be combined with all Modul functional elements
- for flush mounting
- IP55 for usage in humid areas
- in accordance with CEI 23-48, EN 60670



- AQ31PW
- AQ31GY

OHIŠJE PO CUBO IP55 3M

- ohišje IP55 3M
- za podometno pritrditev
- IP55 za vgradnjo v vlažne prostore
- ustreza CEI 23-48, EN 60670

BOX PO CUBO IP55 3M

- box IP55 3M
- for flush mounting
- IP55 for usage in humid areas
- in accordance with CEI 23-48, EN 60670

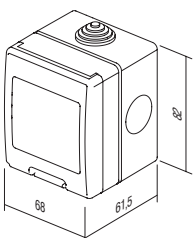

AQ20

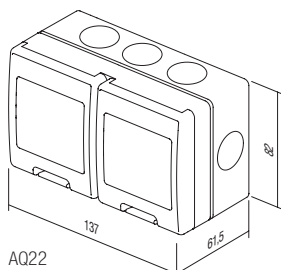

AQ22

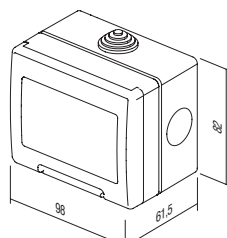

AQ30

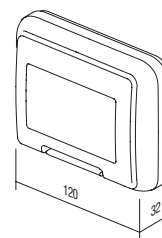

AQ31

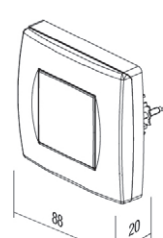

AQ21

TRUNKING SYSTEM ALUMINIUM

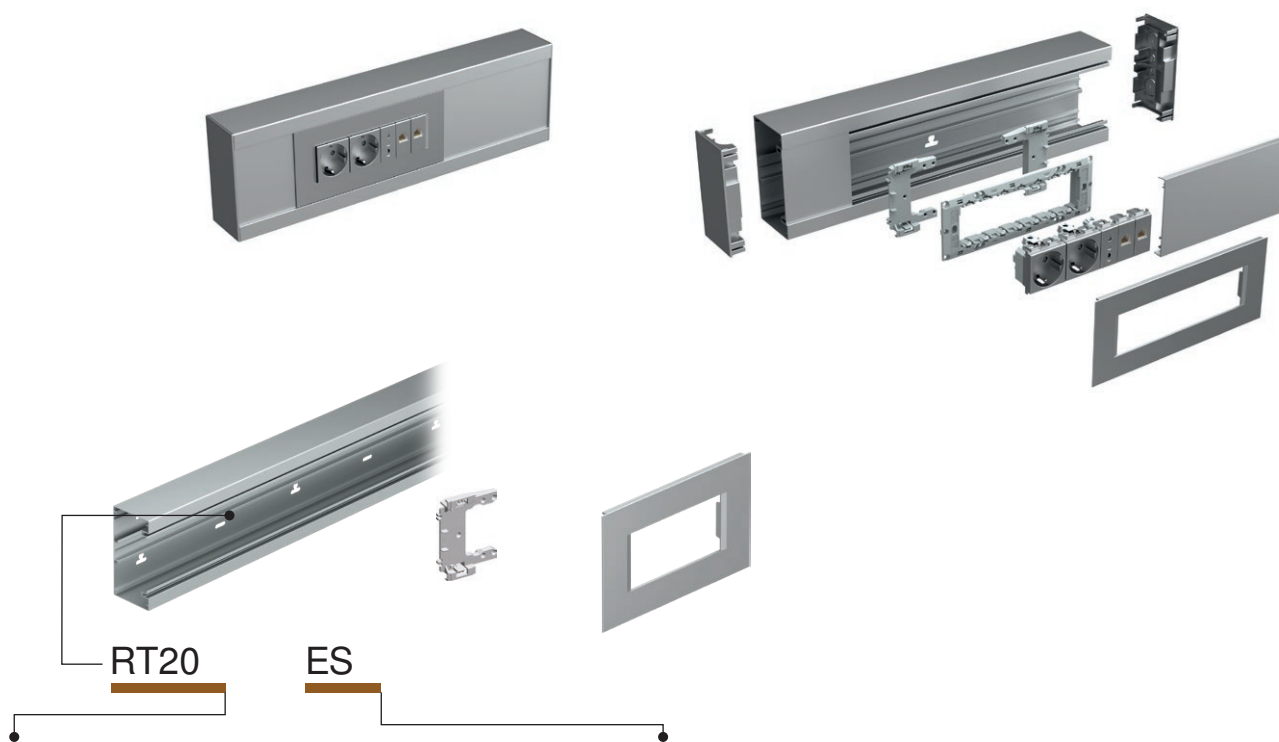

| tip type | naziv description | velikost size | barva colour |
|-------------|----------------------------------|------------------|---------------------------------------|
| RT10 | ADAPTER MA 92 ADAPTER MA 92 | / | ■ ES srebrna-mat elox silver-mat |
| RT12 | OKVIR MA 92 COVER PLATE MA 92 | 2/3M | □ PW bela-mat (RAL 9016) white-mat |
| RT14 | OKVIR MA 92 COVER PLATE MA 92 | 4M | |
| ⋮ | ⋮ | ⋮ | |

ADAPTER MA 92



RT10

- adapter za pritrditev nosilcev 2/3M, 4M ali 7M Modul na kanal MA brez doze
- vsak nosilec potrebuje dva adapterja
- ustreza EN 50085-1

ADAPTER MA 92

- adapter for fixing mounting frames 2/3M, 4M or 7M on MA trunking without box
- each mounting frame needs two adapters
- in accordance with EN 50085-1



OKVIR MA 92 2/3M



■ RT12ES
□ RT12PW

- dekorativni okvir MA 2/3M
- ustreza EN 50085-1

COVER PLATE MA 92 2/3M

- decorative cover plate MA 2/3M
- in accordance with EN 50085-1

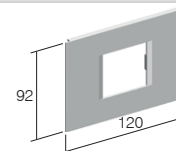

OKVIR MA 92 4M



■ RT14ES
□ RT14PW

- dekorativni okvir MA 4M
- ustreza EN 50085-1

COVER PLATE MA 92 4M

- decorative cover plate MA 4M
- in accordance with EN 50085-1

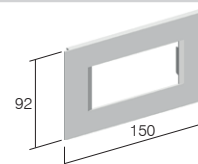

OKVIR MA 92 7M



■ RT17ES
□ RT17PW

- dekorativni okvir MA 7M
- ustreza EN 50085-1

COVER PLATE MA 92 7M

- decorative cover plate MA 7M
- in accordance with EN 50085-1

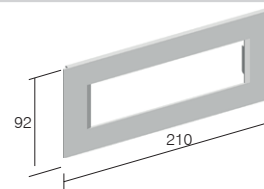

OSNOVA KANALA MA 130x65



- RT20ES
- RT20PW

- osnova kanala iz ekstrudiranega aluminija
- višina 130mm, dolžina 2m
- DIN letev 35mm na dnu
- ustreza EN 50085-1

TRUNKING BASE MA 130x65

- trunking base from extruded aluminium
- height 130mm, length 2m
- DIN - rail 35mm shape on bottom
- in accordance with EN 50085-1

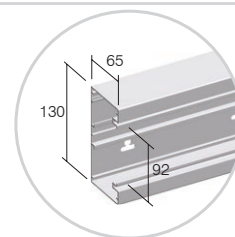

OSNOVA KANALA MA 165x65

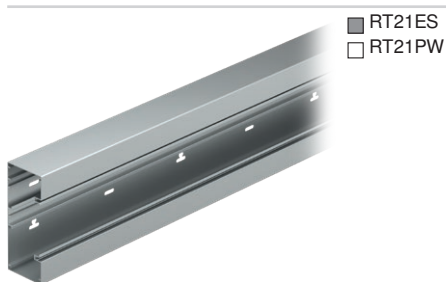

- RT21ES
- RT21PW

- osnova kanala iz ekstrudiranega aluminija
- višina 165mm, dolžina 2m
- DIN letev 35mm na dnu
- ustreza EN 50085-1

TRUNKING BASE MA 165x65

- trunking base from extruded aluminium
- height 165mm, length 2m
- DIN - rail 35mm shape on bottom
- in accordance with EN 50085-1

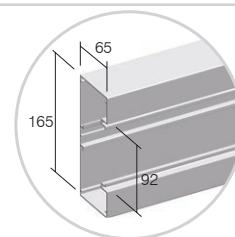

POKROV KANALA MA 92

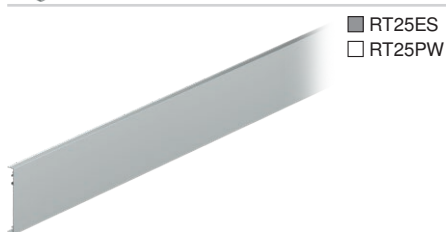

- RT25ES
- RT25PW

- pokrov kanala iz ekstrudiranega aluminija
- višina 92mm, dolžina 2m
- ustreza EN 50085-1

FRONT COVER MA 92

- front cover from extruded aluminium
- height 92mm, length 2m
- in accordance with EN 50085-1

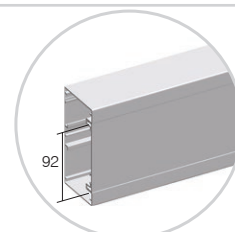

PREGRADA MA 43



RT30

- pregrada kanala iz ekstrudiranega polimera
- globina 43mm, dolžina 2m
- ustreza EN 50085-1

CABLE SHELF MA 43

- cable shelf from extruded polymer
- depth 43mm, length 2m
- in accordance with EN 50085-1

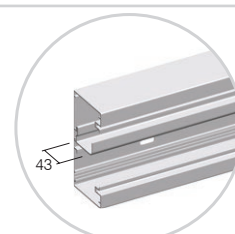

PREGRADA MA 43 AL



RT31

- pregrada kanala iz ekstrudiranega aluminija
- globina 43mm, dolžina 2m
- ustreza EN 50085-1

CABLE SHELF MA 43 AL

- cable shelf from extruded aluminium
- depth 43mm, length 2m
- in accordance with EN 50085-1

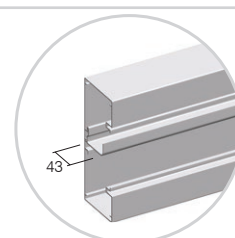

PREGRADA MA 43 AL DVOJNA



RT32

- dvojna pregrada kanala iz ekstrudiranega aluminija
- globina 43mm, dolžina 2m
- ustreza EN 50085-1

CABLE SHELF MA 43 AL DOUBLE

- double cable shelf from extruded aluminium
- depth 43mm, length 2m
- in accordance with EN 50085-1

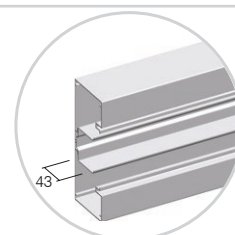

TRUNKING SYSTEM ALUMINIUM

| | | | |
|--|----------------------|--|--|
| | ■ RT35ES □ RT35PW | KONČNI ELEMENT MA 130x65 - končni element iz polimera - višina 130mm - ustreza EN 50085-1 <i>STOP END MA 130x65</i> - stop end element from polymer - height 130mm - in accordance with EN 50085-1 | |
| | ■ RT36ES □ RT36PW | KONČNI ELEMENT MA 165x65 - končni element iz kovine - višina 165mm - ustreza EN 50085-1 <i>STOP END MA 165x65</i> - stop end element from metal - height 165mm - in accordance with EN 50085-1 | |
| | RT38 | SET RAVNI VEZNI ELEMENT MA 65 - vezni element iz polimera - set vsebuje 2 vezna elementa in vijake - ustreza EN 50085-1 <i>SET JOINING PIECE MA 65</i> - joining piece from polymer - set contains two pieces and screws - in accordance with EN 50085-1 | |
| | ■ RT40ES □ RT40PW | UNIVERZALNI KOT MA 130x65 - univerzalni kotni element - višina 130mm - ustreza EN 50085-1 <i>UNIVERSAL CORNER MA 130x65</i> - universal corner element - height 130mm - in accordance with EN 50085-1 | |
| | ■ RT41ES □ RT41PW | UNIVERZALNI KOT MA 165x65 - univerzalni kotni element - višina 165mm - ustreza EN 50085-1 <i>UNIVERSAL CORNER MA 165x65</i> - universal corner element - height 165mm - in accordance with EN 50085-1 | |
| | RT42 | OZEMLJITVENA SPONKA MA 2x A6.3 - ozemljitvena sponka za ozemljitev osnove in pokrova kanala - ustreza EN 50085-1 <i>EARTHING PIECE MA 2x A6.3</i> - earthing piece for earthing of trunking base and front cover - in accordance with EN 50085-1 | |
| | ■ RT43ES □ RT43PW | L KOTNI ELEMENT MA 130x65 / 130 - univerzalni L kotni element iz aluminija - višina 130mm, dolžina 400mm - vezava na MA 130x65 - ustreza EN 50085-1 <i>L-BEND MA 130x65 / 130</i> - universal L bend element from aluminium - height 130mm, length 400mm - connection on MA 130x65 - in accordance with EN 50085-1 | |

L KOTNI ELEMENT MA 165x65 / 130



- RT44ES
- RT44PW

- univerzalni L kotni element iz aluminija
- višina 165mm, dolžina 400mm
- vezava na MA 130x65
- ustreza EN 50085-1

L-BEND MA 165x65 / 130

- universal L bend element from aluminium
- height 165mm, length 400mm
- connection on MA 130x65
- in accordance with EN 50085-1

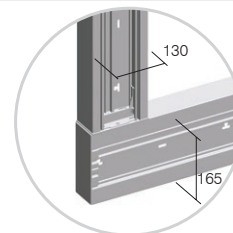

L KOTNI ELEMENT MA 165x65 / 165



- RT47ES
- RT47PW

- univerzalni L kotni element iz aluminija
- višina 165mm, dolžina 400mm
- vezava na MA 165x65
- ustreza EN 50085-1

L-BEND MA 165x65 / 165

- universal L bend element from aluminium
- height 165mm, length 400mm
- connection on MA 165x65
- in accordance with EN 50085-1

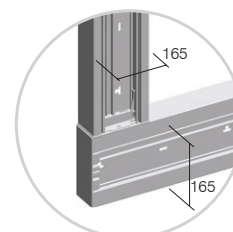

T ELEMENT MA 130x65 / 130



- RT45ES
- RT45PW

- univerzalni T kotni element iz aluminija
- višina 130mm, dolžina 400mm
- vezava na MA 130x65
- ustreza EN 50085-1

T-BEND MA 130x65 / 130

- universal T bend element from aluminium
- height 130mm, length 400mm
- connection on MA 130x65
- in accordance with EN 50085-1

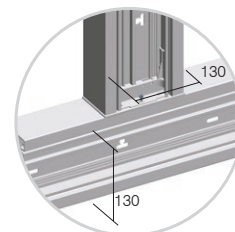

T ELEMENT MA 165x65 / 130



- RT46ES
- RT46PW

- univerzalni T kotni element iz aluminija
- višina 165mm, dolžina 400mm
- vezava na MA 130x65
- ustreza EN 50085-1

T-BEND MA 165x65 / 130

- universal T bend element from aluminium
- height 165mm, length 400mm
- connection on MA 130x65
- in accordance with EN 50085-1

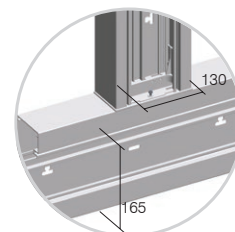

T ELEMENT MA 165x65 / 165



- RT48ES
- RT48PW

- univerzalni T kotni element iz aluminija
- višina 165mm, dolžina 400mm
- vezava na MA 165x65
- ustreza EN 50085-1

T-BEND MA 165x65 / 165

- universal T bend element from aluminium
- height 165mm, length 400mm
- connection on MA 165x65
- in accordance with EN 50085-1

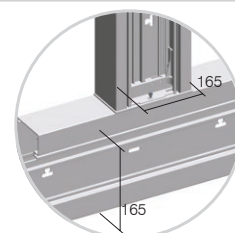

MA je modularni sistem za velikosti: 2M, 4M, 7M

MA trunking is based on modular system making 2M, 4M or 7M combinations of elements

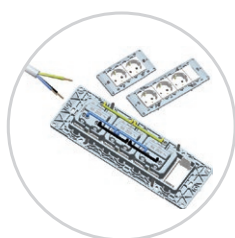

Modul vsebuje tudi elemente pripravljene za hitro montažo

In Modul we provide special elements for quick installation

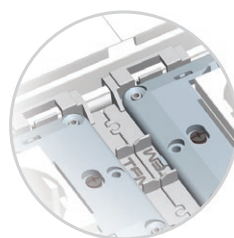

Adapter MA omogoča natančno pozicioniranje na rob kanala

With Adapter MA exact positioning without extra effort is provided

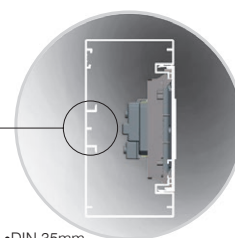

Montaža brez doze pomeni več prostora za kable, DIN letev oblika EN-60715

Mounted without box means more space for cables, DIN-rail base shape EN-60715

T R U N K I N G S Y S T E M A L U M I N I U M

**NOSILEC STEBRIČKA MA ENOJNI 130x65**

- RT50ES
- RT50PW

- nosilec za pritrnitev kanala MA130 v tla in/ali v strop prostora
- ustreza EN 50085-1

FIXING PLATE MA SINGLE 130x65

- fixing plate for fixing trunking base MA130 on the floor
and/or on the ceiling
- in accordance with EN 50085-1



- RT51ES
- RT51PW

NOSILEC STEBRIČKA MA DVOJNI 130x65

- nosilec za pritrnitev dveh kanalov MA130 v tla
in/ali v strop prostora
- ustreza EN 50085-1

FIXING PLATE MA DOUBLE 130x65

- fixing plate for fixing two trunking bases MA130 on the
floor and/or on the ceiling
- in accordance with EN 50085-1

**STEBRIČEK MA 130x65x500**

- RT52ES
- RT52PW

- instalacijski stebriček MA
- višina 500mm
- nosilec 7M vgrajen
- ustreza EN 50085-1

SERVICE POST MA 130x65x500

- service post MA
- height 500mm
- mounting frame 7M included
- in accordance with EN 50085-1

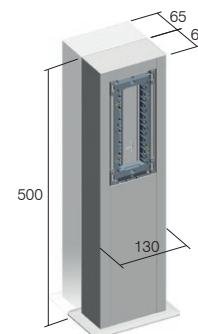
**STEBRIČEK MA DVOJNI 130x130x500**

- RT53ES
- RT53PW

- instalacijski stebriček MA dvojni
- višina 500mm
- nosilca 7M vgrajena
- ustreza EN 50085-1

SERVICE POST MA DOUBLE 130x130x500

- service post MA double
- height 500mm
- mounting frames 7M included
- in accordance with EN 50085-1

| Presek vodnika / Cable intersection mm ² | Uporabni presek kablov / Cable cross-section (mm ²) | | | | |
|---|---|------------------------|------------------------|------------------------|-------------------------|
| | 1 vodnik / 1 wire | 2 vodnika / 2 wires | 3 vodniki / 3 wires | 4 vodniki / 4 wires | 5 vodnikov / 5 wires |
| 1,5 | 44 | 111 | 121 | 144 | 169 |
| 2,5 | 49 | 133 | 157 | 169 | 211 |
| 4 | 58 | 169 | 183 | 211 | 256 |
| 6 | 68 | 196 | 225 | 256 | 307 |

| Kapaciteta kanala / Trunk capacity | | | | |
|------------------------------------|--------------------------------|--|--------------------------------|--|
| kanal / Trunk | MA 130x65 prazen / empty | MA 130x65 z Modul opremo / with Modul switches and sockets | MA 165x65 prazen / empty | MA 130x65 z Modul opremo / with Modul switches and sockets |
| kapaciteta capacity | 7600 mm ² | 5500 mm ² | 9900 mm ² | 7800 mm ² |
| max ø | 54 mm | 2x42 mm | 54 mm | 2x42 mm |

T A L N E D O Z E M T

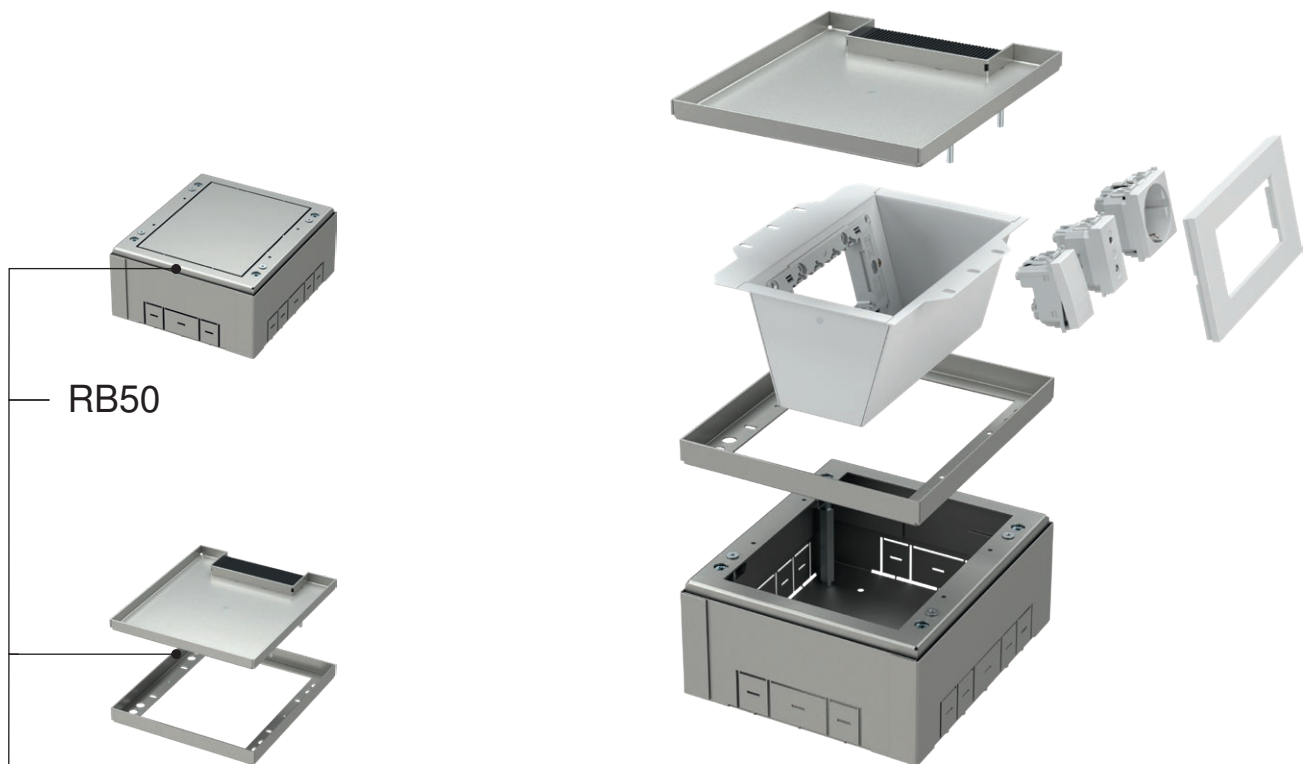

| tip type | naziv description | tehnični opis technical data |
|-------------|--|---------------------------------|
| RB50 | VGRADNO OHIŠJE TALNE DOZE FLOOR BOX BASE | 4M |
| RB65S1 | POKROV TALNE DOZE FLOOR DISTRIBUTION BOX COVER | 4M |
| RB60 | VLOŽEK TALNE DOZE INSERT FOR FLOOR DISTRIBUTION BOX | 4M |
| . | . | . |
| . | . | . |

| | RB65S1 | RB66S1 | RB67S2 | RB68S2 |
|---|--------|--------|--------|--------|
| X | 177 | 178 | 265 | 516,5 |
| Y | 200,5 | 265 | 265 | 265 |
| Z | 17,5 | 17,5 | 17,5 | 17,5 |

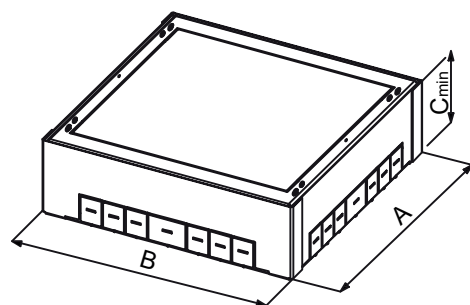
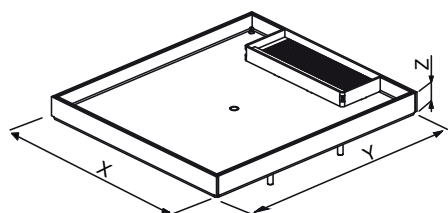

| | RB50 | RB51 | RB52 | RB53 |
|---|-------|-------|-------|------|
| A | 208,5 | 273 | 273 | 273 |
| B | 182 | 182,5 | 269,5 | 521 |
| C | 83 | 83 | 83 | 83 |

F L O O R B O X E S M T

VGRADNO OHIŠJE TALNE DOZE 4M



RB50

- vgradno ohišje 4M
- kovinsko, cinkano
- za vgradnjo v tlak ali dvojni pod
- vgradne mere 208,5 x 182 mm, globina min 83 mm
- nastavljiva višina 83–128 mm
- ustreza EN 5005-1 in EN 50085-2-2

FLOOR BOX BASE 4M

- floor box base 4M
- metal, galvanized
- for installation in a floor or double floor
- mounting dimensions 208.5x182mm, min. depth 83mm
- adjustable height 83-128mm
- in accordance with EN 5005-1 and EN 50085-2-2

VLOŽEK TALNE DOZE 4M



RB60

- vložek talne doze 4M
- kovinski, barva bela RAL 9006
- nosilec MODUL 4M vgrajen
- ustreza EN 5005-1 in EN 50085-2-2

INSERT FOR FLOOR DISTRIBUTION BOX 4M

- insert for floor box 4M
- metal, colour white RAL 9006
- mounting frame MODUL 4M included
- in accordance with EN 5005-1 and EN 50085-2-2

POKROV TALNE DOZE 4M



RB65S1

- pokrov doze 4M
- kovinski, cinkan
- vgradne mere 200,5 x 177 mm, globina 17,5 mm
- debelina talne obloge pokrova do 11,5 mm
- ustreza EN 5005-1 in EN 50085-2-2

FLOOR DISTRIBUTION BOX COVER 4M

- floor box cover 4M
- metal, galvanized
- mounting dimensions 200.5x177mm, depth 17.5mm
- floor thickness up to 11.5mm
- in accordance with EN 5005-1 and EN 50085-2-2

VGRADNO OHIŠJE TALNE DOZE 7M



RB51

- vgradno ohišje 7M
- kovinsko, cinkano
- za vgradnjo v tlak ali dvojni pod
- vgradne mere 273 x 182,5 mm, globina min 83 mm
- nastavljiva višina 83–128 mm
- ustreza EN 5005-1 in EN 50085-2-2

FLOOR BOX BASE 7M

- floor box base 7M
- metal, galvanized
- for installation in a floor or double floor
- mounting dimensions 273x182.5mm, min. depth 83mm
- adjustable height 83-128mm
- in accordance with EN 5005-1 and EN 50085-2-2

VLOŽEK TALNE DOZE 7M



RB61

- vložek talne doze 7M
- kovinski, barva bela RAL 9006
- nosilec MODUL 7M vgrajen
- ustreza EN 5005-1 in EN 50085-2-2

INSERT FOR FLOOR DISTRIBUTION BOX 7M

- insert for floor box 7M
- metal, colour white RAL 9006
- mounting frame MODUL 7M included
- in accordance with EN 5005-1 and EN 50085-2-2

POKROV TALNE DOZE 7M



RB66S1

- pokrov doze 7M
- kovinski, cinkan
- vgradne mere 265 x 178 mm, globina 17,5 mm
- debelina talne obloge pokrova do 11,5 mm
- ustreza EN 5005-1 in EN 50085-2-2

FLOOR DISTRIBUTION BOX COVER 7M

- floor box cover 7M
- metal, galvanized
- mounting dimensions 265x178mm, depth 17.5mm
- floor thickness up to 11.5mm
- in accordance with EN 5005-1 and EN 50085-2-2

VGRADNO OHIŠJE TALNE DOZE 2X7M



RB52

- vgradno ohišje 2 x 7M
- kovinsko, cinkano
- za vgradnjo v tlak ali dvojni pod
- vgradne mere 273 x 269,5 mm, globina min 83 mm
- nastavljiva višina 83–128 mm
- ustreza EN 5005-1 in EN 50085-2-2

FLOOR BOX BASE 2X7M

- floor box base 2X7M
- metal, galvanized
- for installation in a floor or double floor
- mounting dimensions 273x269.5mm, min. depth 83mm
- adjustable height 83-128mm
- in accordance with EN 5005-1 and EN 50085-2-2

VLOŽEK TALNE DOZE 2X7M



RB62

- vložek talne doze 2 x 7M
- kovinski, barva bela RAL 9006
- nosilca MODUL 2 x 7M vgrajena
- ustreza EN 5005-1 in EN 50085-2-2

INSERT FOR FLOOR DISTRIBUTION BOX 2X7M

- insert for floor box 2x7M
- metal, colour white RAL 9006
- mounting frames MODUL 2x7M included
- in accordance with EN 5005-1 and EN 50085-2-2

POKROV TALNE DOZE 2X7M

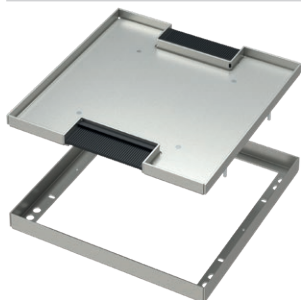

RB67S2

- pokrov doze 2 X 7M
- kovinski, cinkan
- vgradne mere 265 x 265 mm, globina 17,5 mm
- debelina talne obloge pokrova do 11,5 mm
- ustreza EN 5005-1 in EN 50085-2-2

FLOOR DISTRIBUTION BOX COVER 2X7M

- floor box cover 2x7M
- metal, galvanized
- mounting dimensions 265x265mm, depth 17.5mm
- floor thickness up to 11.5mm
- in accordance with EN 5005-1 and EN 50085-2-2

VGRADNO OHIŠJE TALNE DOZE 4X7M

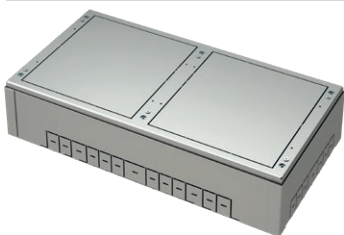

RB53

- vgradno ohišje 4 x 7M
- kovinsko, cinkano
- za vgradnjo v tlak ali dvojni pod
- vgradne mere 273 x 521 mm, globina min 83 mm
- nastavljiva višina 83–128 mm
- ustreza EN 5005-1 in EN 50085-2-2

FLOOR BOX BASE 4X7M

- floor box base 4X7M
- metal, galvanized
- for installation in a floor or double floor
- mounting dimensions 273x521mm, min. depth 83mm
- adjustable height 83-128mm
- in accordance with EN 5005-1 and EN 50085-2-2

VLOŽEK TALNE DOZE 2X7M

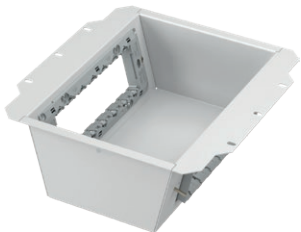

RB62

- vložek talne doze 2 x 7M
- kovinski, barva bela RAL 9006
- nosilca MODUL 2 x 7M vgrajena
- ustreza EN 5005-1 in EN 50085-2-2

INSERT FOR FLOOR DISTRIBUTION BOX 2X7M

- insert for floor box 2x7M
- metal, colour white RAL 9006
- mounting frames MODUL 2x7M included
- in accordance with EN 5005-1 and EN 50085-2-2

POKROV TALNE DOZE 4X7M



RB68S2

- pokrov doze 4 X 7M
- kovinski, cinkan
- vgradne mere 265 x 516,5 mm, globina 17,5 mm
- debelina talne obloge pokrova do 11,5 mm
- ustreza EN 5005-1 in EN 50085-2-2

FLOOR DISTRIBUTION BOX COVER 4X7M

- floor box cover 4x7M
- metal, galvanized
- mounting dimensions 265x516.5mm, depth 17.5mm
- floor thickness up to 11.5mm
- in accordance with EN 5005-1 and EN 50085-2-2



RB55S1

| tip type | naziv description | tehnični opis technical data |
|-------------|---|---------------------------------|
| RB55S1 | TALNA DOZA ZA DVOJNA TLA S POKROVOM FLOOR BOX WITH COVER FOR DOUBLE FLOORS | 4M |
| RB60 | VLOŽEK TALNE DOZE INSERT FOR FLOOR DISTRIBUTION BOX | 4M |
| ⋮ | ⋮ | ⋮ |
| ⋮ | ⋮ | ⋮ |

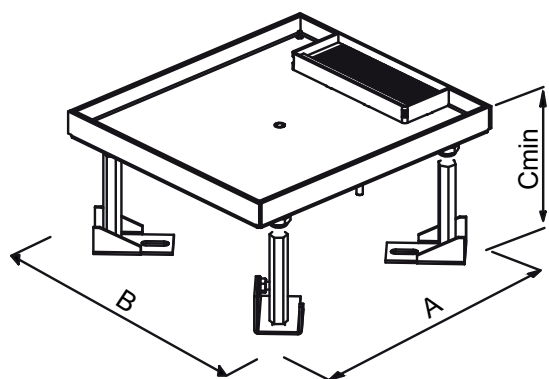

| | RB55S1 | RB56S1 | RB57S2 | RB58S2 |
|---|--------|--------|--------|--------|
| A | 200,5 | 265 | 265 | 265 |
| B | 177 | 178 | 265 | 516,5 |
| C | 100 | 100 | 100 | 100 |

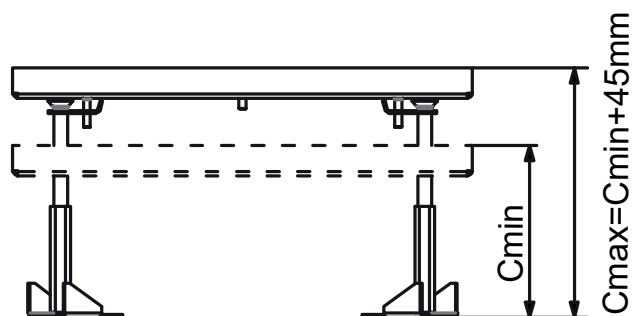

TALNA DOZA ZA DVOJNA TLA S POKROVOM 4M



RB55S1

- talna doza za dvojna tla 4M
- kovinska, cinkana
- vgradne mere 200,5 x 177 mm, globina min 100 mm
- nastavljiva višina 100–145 mm
- debelina talne obloge pokrova do 11,5 mm
- ustreza EN 5005-1 in EN 50085-2-2

FLOOR BOX WITH COVER FOR DOUBLE FLOORS 4M

- floor box base 4M
- metal, galvanized
- mounting dimensions 200.5x177mm, min. depth 100mm
- adjustable height 100-145mm
- floor thickness up to 11.5mm
- in accordance with EN 5005-1 and EN 50085-2-2

VLOŽEK TALNE DOZE 4M



RB60

- vložek talne doze 4M
- kovinski, barva bela RAL 9006
- nosilec MODUL 4M vgrajen
- ustreza EN 5005-1 in EN 50085-2-2

INSERT FOR FLOOR DISTRIBUTION BOX 4M

- insert for floor box 4M
- metal, colour white RAL 9006
- mounting frame MODUL 4M included
- in accordance with EN 5005-1 and EN 50085-2-2

TALNA DOZA ZA DVOJNA TLA S POKROVOM 7M



RB56S1

- talna doza za dvojna tla 7M
- kovinska, cinkana
- vgradne mere 265 x 178 mm, globina min 100 mm
- nastavljiva višina 100–145 mm
- debelina talne obloge pokrova do 11,5 mm
- ustreza EN 5005-1 in EN 50085-2-2

FLOOR BOX WITH COVER FOR DOUBLE FLOORS 7M

- floor box base 7M
- metal, galvanized
- mounting dimensions 265x178mm, min. depth 100mm
- adjustable height 100-145mm
- floor thickness up to 11.5mm
- in accordance with EN 5005-1 and EN 50085-2-2

VLOŽEK TALNE DOZE 7M



RB61

- vložek talne doze 7M
- kovinski, barva bela RAL 9006
- nosilec MODUL 7M vgrajen
- ustreza EN 5005-1 in EN 50085-2-2

INSERT FOR FLOOR DISTRIBUTION BOX 7M

- insert for floor box 7M
- metal, colour white RAL 9006
- mounting frame MODUL 7M included
- in accordance with EN 5005-1 and EN 50085-2-2

TALNA DOZA ZA DVOJNA TLA S POKROVOM 2X7M



RB57S2

- talna doza za dvojna tla 2 x 7M
- kovinska, cinkana
- vgradne mere 265 x 265 mm, globina min 100 mm
- nastavljiva višina 100–145 mm
- debelina talne obloge pokrova do 11,5 mm
- ustreza EN 5005-1 in EN 50085-2-2

FLOOR BOX WITH COVER FOR DOUBLE FLOORS 2X7M

- floor box base 2x7M
- metal, galvanized
- mounting dimensions 265x265mm, min. depth 100mm
- adjustable height 100-145mm
- floor thickness up to 11.5mm
- in accordance with EN 5005-1 and EN 50085-2-2

VLOŽEK TALNE DOZE 2X7M



RB62

- vložek talne doze 2 x 7M
- kovinski, barva bela RAL 9006
- nosilca MODUL 2 x 7M vgrajena
- ustreza EN 5005-1 in EN 50085-2-2

INSERT FOR FLOOR DISTRIBUTION BOX 2X7M

- insert for floor box 2x7M
- metal, colour white RAL 9006
- mounting frames MODUL 2x7M included
- in accordance with EN 5005-1 and EN 50085-2-2

TALNA DOZA ZA DVOJNA TLA S POKROVOM 4X7M



RB58S2

- talna doza za dvojna tla 4 x 7M
- kovinska, cinkana
- vgradne mere 265 x 516,5 mm, globina min 100 mm
- nastavljiva višina 100–145 mm
- debelina talne obloge pokrova do 11,5 mm
- ustreza EN 5005-1 in EN 50085-2-2

FLOOR BOX WITH COVER FOR DOUBLE FLOORS 4X7M

- floor box base 4x7M
- metal, galvanized
- mounting dimensions 265x516.5mm, min. depth 100mm
- adjustable height 100-145mm
- floor thickness up to 11.5mm
- in accordance with EN 5005-1 and EN 50085-2-2

VLOŽEK TALNE DOZE 2X7M



RB62

- vložek talne doze 2 x 7M
- kovinski, barva bela RAL 9006
- nosilca MODUL 2 x 7M vgrajena
- ustreza EN 5005-1 in EN 50085-2-2

INSERT FOR FLOOR DISTRIBUTION BOX 2X7M

- insert for floor box 2x7M
- metal, colour white RAL 9006
- mounting frames MODUL 2x7M included
- in accordance with EN 5005-1 and EN 50085-2-2

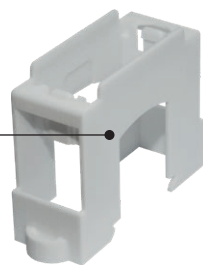

RB10

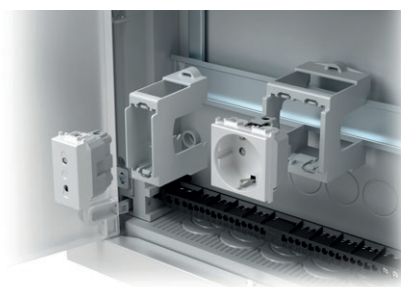

| tip type | naziv description | tehnični opis technical data |
|-------------|---|---------------------------------|
| RB10 | ADAPTER ZA DIN LETEV <i>ADAPTER FOR DIN RAIL</i> | 35mm 1M |
| RB11 | ADAPTER ZA DIN LETEV <i>ADAPTER FOR DIN RAIL</i> | 35mm 2M |
| ⋮ | ⋮ | ⋮ |

ADAPTER ZA DIN LETEV 35mm 1M



RB10

- adapter MODUL 1M
- za DIN letev 35mm
- ustreza EN 50022

ADAPTER FOR DIN RAIL 35mm 1M

- adapter MODUL 1M
- for DIN rail 35mm
- in accordance with EN 50022

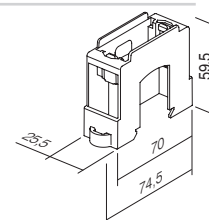

ADAPTER ZA DIN LETEV 35mm 2M



RB11

- adapter MODUL 2M
- za DIN letev 35mm
- ustreza EN 50022

ADAPTER FOR DIN RAIL 35mm 2M

- adapter MODUL 2M
- for DIN rail 35mm
- in accordance with EN 50022

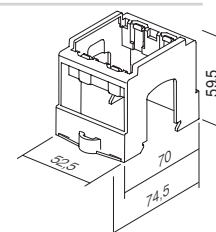

SWITCH
LOGIQ



TEM

LOGIQ

VSEPRISOTNA SAMOZAVEST **Narejen za vsak prostor**

Oblika, ki je doma v vsakem prostoru. Univerzalne linije stikal pustijo svoj pečat v modernih delovnih okoljih ali v bolj domačih toplih bivalnih prostorih. Za vsako vašo željo vam družina stikal LOGIQ ponuja preprosto in logično rešitev.

OMNIPRESENT CONFIDENCE made for every room

A shape for every room. The switches have universal lines that leave a mark in both modern work environments as well as in cosy, comfortable living spaces. The LOGIQ family offers a simple and logical solution for your every wish.



LOGIQ

HARMONIJA BARV Izberi svoj odtenek

Družino LOGIQ odlikuje logičen izbor preverjenih in elegantnih barvnih odtenkov, ki jih imajo uporabniki najraje. Ne prilagajajte se vi, linija LOGIQ se prilagaja vam, zato vam vedno lahko izdelamo tudi barvni ton, prilagojen vašim posebnim željam. Logično.

HARMONY OF COLOURS Choose your hue

The LOGIQ family prides itself on its logical range of verified and elegant hues known and loved by our clients. Don't compromise, the LOGIQ family has you covered. We can always create the hue of colour in accordance with your special request. Logically.

- | | |
|---------------------|--------------------|
| ■ antracit | <i>anthracite</i> |
| ■ titan | <i>titanium</i> |
| □ bela-sijaj | <i>polar white</i> |



NEOMEJENA DOMIŠLJIJA

Sestavi svojo kombinacijo

Družina LOGIQ omogoča sestavljanje poljubnih kombinacij. Za enostavno kombiniranje smo za vas izdelali uporabno dopolnitev, ki vam bo olajšala nizanje vodoravnih in navpičnih linij. Tako imenovani sistem 55/55 vam omogoča, da lahko vselej uporabite iste univerzalne elemente. Že veste, česa si želite? Ne skrbite, stikala LOGIQ berejo vaše misli.

LIMITLESS IMAGINATION

Create your own combination

The LOGIQ family allows you to create your own combination. To make combining simple, we have created a useful system that supports the sequencing of horizontal and vertical lines. The so-called 55/55 system allows you to use the same universal elements every time. Know what you want? Don't worry, the LOGIQ switches can read your mind.



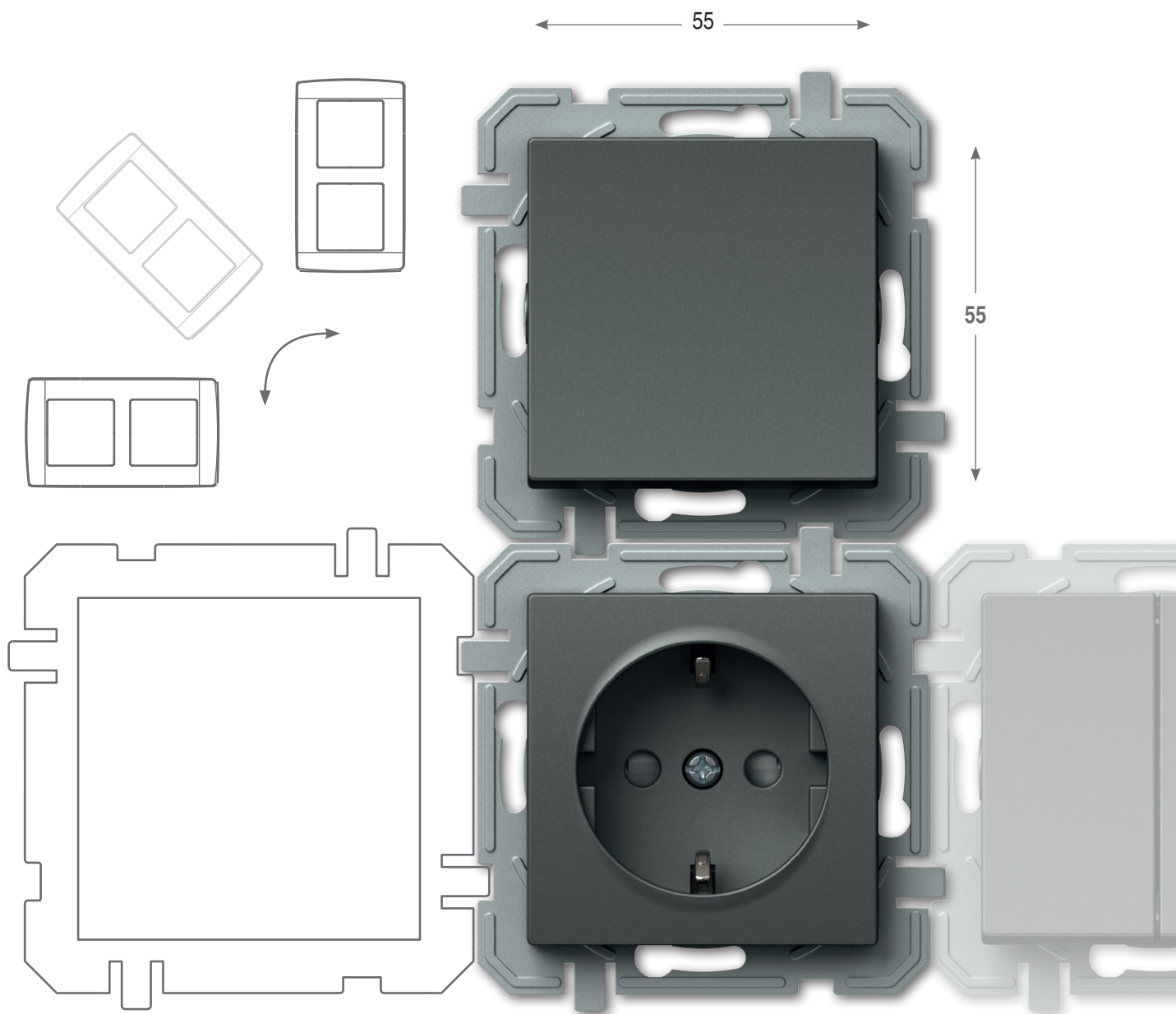

PREPROSTO ZA NAJZAHTEVNEJŠE

Družina LOGIQ so stikala, regulatorji, senzorji, vtičnice za vsak namen in vse na enem mestu. Lahko jih uporabite posamično ali v nizu. Kot vsaka družina, ki raste in se razvija, bomo tudi našo ponudbo razvijali naprej, skladno z vašimi potrebami in željami. Radi vam prisluhnemo in vam ponudimo rešitev, ki bo enostavno in logično nadaljevanje zgodbe družine LOGIQ.

SIMPLE FOR THE MOST DEMANDING

The LOGIQ family offers switches, regulators, sensors, and sockets for every purpose in one place. You can use these products individually or in a sequence. Just like every family that grows and develops, the LOGIQ family will continue to develop our range of products in accordance with your needs and wishes. We are happy to listen to you and offer a solution which will simply and logically continue the story of the LOGIQ family.



VSE NA ENEM MESTU IN ŠE VEČ

ALL IN ONE PLACE AND MORE

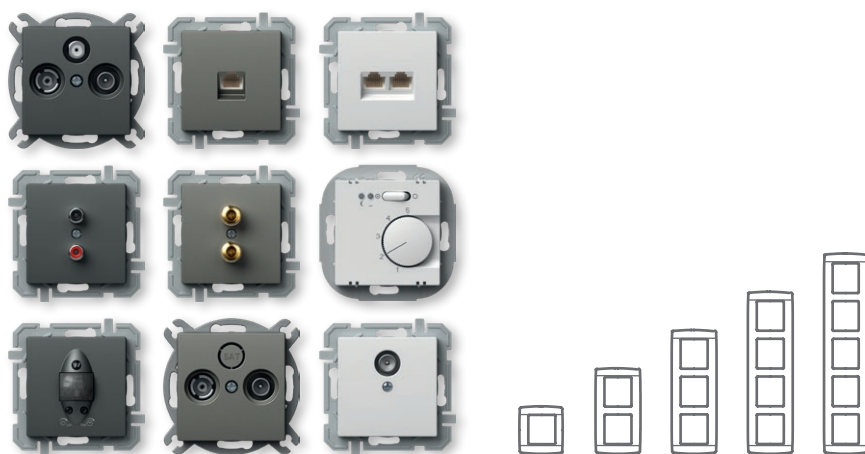

LOGIČNA MONTAŽA

LOGIQ je rešitev za sistem standardnih okroglih doz. Z njim lahko načrtujete tako enostavne kot tudi zahtevnejše inštalacije, novogradnje in adaptacije. Sistem odlikujejo brezvijačni kontakti, ki vam prihranijo čas pri vgradnji elementov.

LOGICAL INSTALLATION

LOGIQ is a solution for the system of standardized round installations boxes. It can be used for simple as well as more demanding installations, new buildings and adaptations. The system is characterised by plug-in contacts which save time during installation of elements.

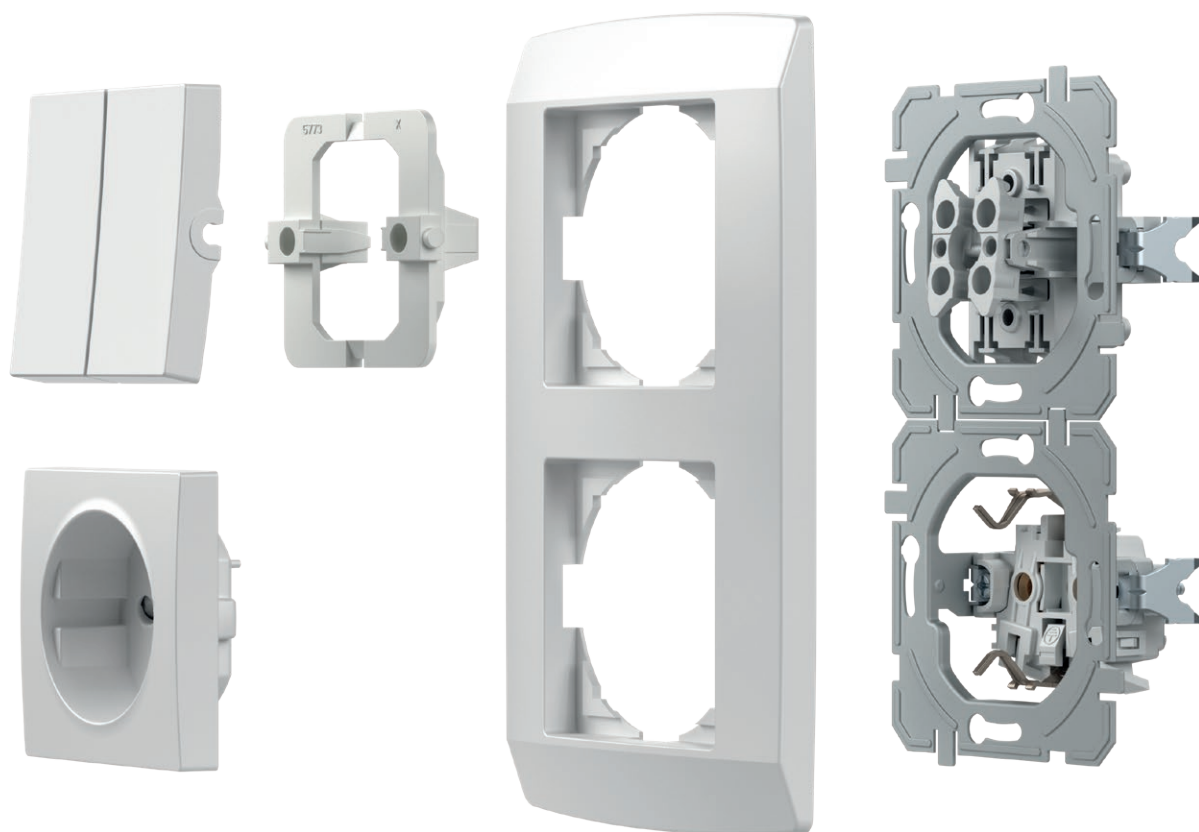

DOBRO JE VEDETI

GOOD TO KNOW



Vse vtičnice imajo vgrajeno varovalo pred dotikom elementov pod napetostjo.

All the sockets are equipped with a safety shutters assuring the protection to live contacts.



Dobro premišljena konstrukcija stikala omogoča enostavno indikacijo tudi naknadno.

The well-thought-out design of the switch enables the easy integration of the indication, including at a later time.



Za zanesljivost preklopa skrbijo kontakti iz srebrove zlitine.

Contacts made of silver alloy guarantee safe switching.



Brezvijačni kontakti omogočajo hitro in zanesljivo priključitev vodnikov. Na isti kontakt lahko pritrdite dva vodnika različnih premerov.

Plug-in contacts enable quick and reliable attachment of wires. Two wires of different diameters can be attached to the same contact.



Krepeljci omogočajo globljo pritrditev (tudi preko keramičnih ploščic ipd.).

Fixing claws enable deeper fixing (also through ceramic tiles, etc.)









Sestavljive doze vam bodo olajšale delo. Prave razdalje so vam zagotovljene.

Easy-fitting installation boxes will make your work easier. Proper lengths are guaranteed.



SQ11
PW
IN
01
XO

| tip type | naziv description | tehnični opis technical data | barva colour | opcijski opis 1 optional data 1 | opcijski opis 2 optional data 2 | opcijski opis 3 optional data 3 |
|-------------|-----------------------------------|---------------------------------|--|--|--|-------------------------------------|
| SQ10 | STIKALO ENOPOLNO SWITCH 1WAY | 10AX 250V~ | <input type="checkbox"/> PW bela - sijaj polar white |  NT nevtral neutral |  01 | XO brez okvirja without cover plate |
| SQ11 | TIPKALO ENOPOLNO PUSH BUTTON 1WAY | 10A 250V~ | <input type="checkbox"/> TI titan titanium |  |  02 | |
| SQ22 | STIKALO DVOPOLNO SWITCH 2POLE | 16AX 250V~ | <input type="checkbox"/> AT antracit anthracite |  |  03 | |
| ... | ... | ... | ... | ... | ... | ... |

STIKALO ENOPOLNO 10AX 250V~



- SQ10PWXO
- SQ10TIXO
- SQ10ATXO

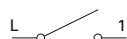

- 10AX 250V~, tip SQ10
 - ustreza EN 60669-1
 - brezvijačna pritrditev vodnikov 1.5-2.5mm²
SWITCH 1WAY 10AX 250V~
 - 10AX 250V~, type SQ10
 - in accordance with EN 60669-1
 - plug-in contacts 1.5-2.5mm²



STIKALO ENOPOLNO 10AX 250V~ __ IN

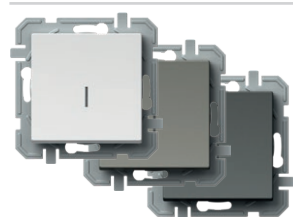

- SQ10PWINXO
- SQ10TIINXO
- SQ10ATINXO

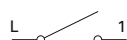

- IN indikator, brez tlivke
 - 10AX 250V~, tip SQ10
 - ustreza EN 60669-1
 - brezvijačna pritrditev vodnikov 1.5-2.5mm²
SWITCH 1WAY 10AX 250V~ __ IN
 - IN indicator, without neon lamp
 - 10AX 250V~, type SQ10
 - in accordance with EN 60669-1
 - plug-in contacts 1.5-2.5mm²



TIPKALO ENOPOLNO 10A 250V~



- SQ11PWXO
- SQ11TIXO
- SQ11ATXO

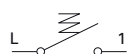

- 10A 250V~, tip SQ11
 - ustreza EN 60669-1
 - brezvijačna pritrditev vodnikov 1.5-2.5mm²
PUSH BUTTON 1WAY 10A 250V~
 - 10A 250V~, type SQ11
 - in accordance with EN 60669-1
 - plug-in contacts 1.5-2.5mm²



TIPKALO ENOPOLNO 10A 250V~ __ IN 01



- SQ11PWIN01XO
- SQ11TIIN01XO
- SQ11ATIN01XO

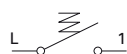

- IN 01 indikator zvonec, brez tlivke
 - 10A 250V~, tip SQ11
 - ustreza EN 60669-1
 - brezvijačna pritrditev vodnikov 1.5-2.5mm²
PUSH BUTTON 1WAY 10A 250V~ __ IN 01
 - IN 01 indicator bell, without neon lamp
 - 10A 250V~, type SQ11
 - in accordance with EN 60669-1
 - plug-in contacts 1.5-2.5mm²





- SQ11PWIN02XO
- SQ11TIIN02XO
- SQ11ATIN02XO



TIPKALO ENOPOLNO 10A 250V~ __ IN 02

- IN 02 indikator luč, brez tlivke
- 10A 250V~, tip SQ11
- ustreza EN 60669-1
- brezvijačna pritrditev vodnikov 1.5-2.5mm²

PUSH BUTTON 1WAY 10A 250V~ __ IN 02

- IN 02 indicator light, without neon lamp
- 10A 250V~, type SQ11
- in accordance with EN 60669-1
- plug-in contacts 1.5-2.5mm²

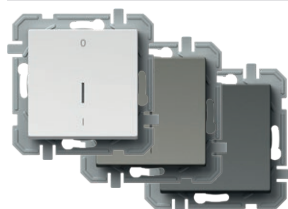

- SQ22PWIN03XO
- SQ22TIIN03XO
- SQ22ATIN03XO

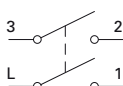

STIKALO DVOPOLNO 16AX 250V~ __ IN 03

- IN 03 nevtral 0-1, brez tlivke
- 16AX 250V~, tip SQ22
- ustreza EN 60669-1
- vijačna pritrditev vodnikov 1.5-2.5mm²

SWITCH 2POLE 16AX 250V~ __ IN 03

- IN 03 neutral 0-1, without neon lamp
- 16AX 250V~, type SQ22
- in accordance with EN 60669-1
- screw contacts 1.5-2.5mm²



- SQ50PWXO
- SQ50TIXO
- SQ50ATXO

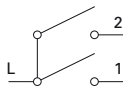

STIKALO SERIJSKO 10AX 250V~

- 10AX 250V~, tip SQ50
- ustreza EN 60669-1
- brezvijačna pritrditev vodnikov 1.5-2.5mm²

SWITCH 2GANG-1WAY 10AX 250V~

- 10AX 250V~, type SQ50
- in accordance with EN 60669-1
- plug-in contacts 1.5-2.5mm²

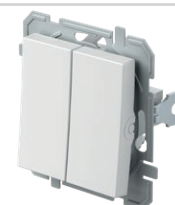

- SQ51PWXO
- SQ51TIXO
- SQ51ATXO

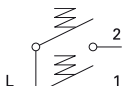

TIPKALO SERIJSKO 10A 250V~

- 10A 250V~, tip SQ51
- ustreza EN 60669-1
- brezvijačna pritrditev vodnikov 1.5-2.5mm²

PUSH BUTTON 2GANG-1WAY 10A 250V~

- 10A 250V~, type SQ51
- in accordance with EN 60669-1
- plug-in contacts 1.5-2.5mm²



- SQ52PWNT09XO
- SQ52TINT09XO
- SQ52ATNT09XO



STIKALO ŽALUZIJSKO 10AX 250V~ __ NT 09

- NT 09 nevtral gor-dol
- 10AX 250V~, tip SQ52
- ustreza EN 60669-1
- brezvijačna pritrditev vodnikov 1.5-2.5mm²
- z mehansko blokado hkratnega vklopa

SWITCH SHUTTERS 10AX 250V~ __ NT 09

- NT 09 neutral up-down
- 10AX 250V~, type SQ52
- in accordance with EN 60669-1
- plug-in contacts 1.5-2.5mm²
- with mechanical interblock

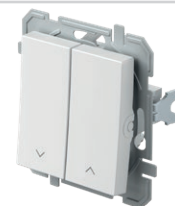

- SQ53PWNT09XO
- SQ53TINT09XO
- SQ53ATNT09XO

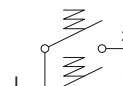

TIPKALO ŽALUZIJSKO 10A 250V~ __ NT 09

- NT 09 nevtral gor-dol
- 10A 250V~, tip SQ53
- ustreza EN 60669-1
- brezvijačna pritrditev vodnikov 1.5-2.5mm²
- z mehansko blokado hkratnega vklopa

PUSH BUTTON SHUTTERS 10A 250V~ __ NT 09

- NT 09 neutral up-down
- 10A 250V~, type SQ53
- in accordance with EN 60669-1
- plug-in contacts 1.5-2.5mm²
- with mechanical interblock

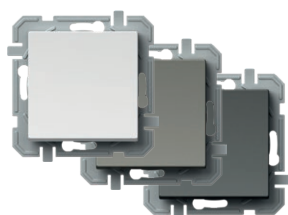

- SQ60PWXO
- SQ60TIXO
- SQ60ATXO

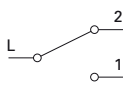

STIKALO MENJALNO 10AX 250V~

- 10AX 250V~, tip SQ60
- ustreza EN 60669-1
- brezvijačna pritrditev vodnikov 1.5-2.5mm²

SWITCH 2WAY 10AX 250V~

- 10AX 250V~, type SQ60
- in accordance with EN 60669-1
- plug-in contacts 1.5-2.5mm²



STIKALO DVOJNO MENJALNO 10AX 250V~



- SQ63PWXO
- SQ63TIXO
- SQ63ATXO

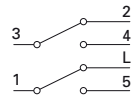

- 10AX 250V~, tip SQ63
- ustreza EN 60669-1
- brezvijačna pritrditev vodnikov 1.5-2.5mm²

SWITCH DOUBLE 2WAY 10AX 250V~

- 10AX 250V~, type SQ63
- in accordance with EN 60669-1
- plug-in contacts 1.5-2.5mm²



STIKALO KRIŽNO 10AX 250V~

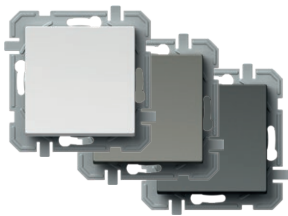

- SQ70PWXO
- SQ70TIXO
- SQ70ATXO



- 10AX 250V~, tip SQ70
- ustreza EN 60669-1
- brezvijačna pritrditev vodnikov 1.5-2.5mm²

SWITCH INTERMEDIATE 10AX 250V~

- 10AX 250V~, type SQ70
- in accordance with EN 60669-1
- plug-in contacts 1.5-2.5mm²



SQ10
SQ11

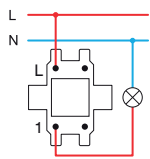

SQ22

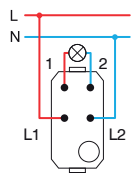

SQ50
SQ51

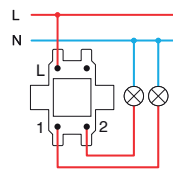

SQ52
SQ53

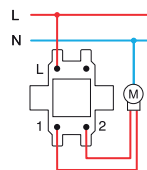

SQ60+SQ60

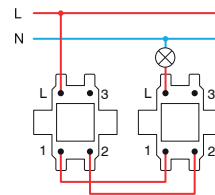

SQ63+SQ63

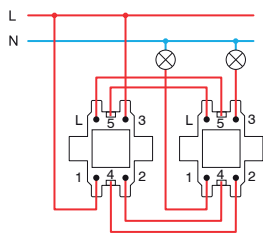

SQ60+SQ70+SQ60

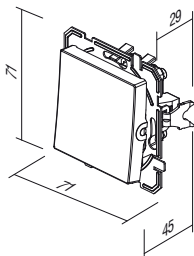
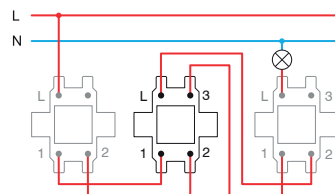

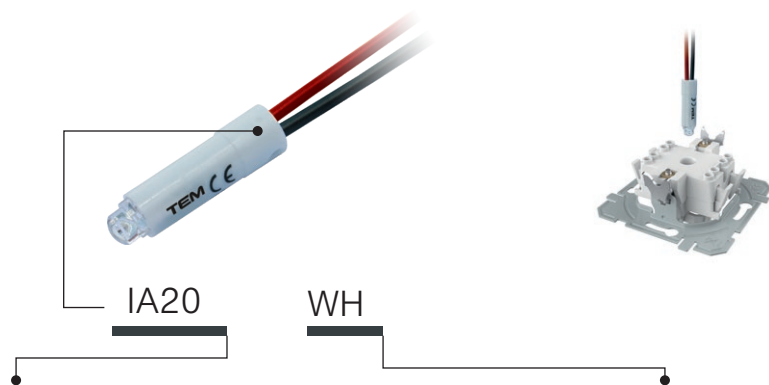

| tip type | naziv description | tehnični opis technical data | barva colour |
|-------------|--|---------------------------------|--|
| IA10 | TLIVKA NEON LAMP | 230V~ 0,34W | <input type="checkbox"/> WH bela white |
| IA20 | LED SIGNALIZACIJA LED SIGNALLING UNIT | 230V~ 0,40W | <input checked="" type="checkbox"/> BL modra blue |
| IA21 | LED SIGNALIZACIJA LED SIGNALLING UNIT | 24V AC/DC 0,20W | <input checked="" type="checkbox"/> RD rdeča red |
| . | . | . | <input checked="" type="checkbox"/> GR zelena green |
| . | . | . | <input checked="" type="checkbox"/> OR oranžna orange |

TLIVKA 230V~ 0,34W

 IA10OR

- za indikacijo, signalizacijo ali stalno signalizacijo stikala
- v kombinaciji s tipko z indikatorjem

NEON LAMP 230V~ 0,34W

- for indication, signalling or permanent signalling
- in combination with a button featuring an indicator

LED SIGNALIZACIJA 230V AC/DC 0,40W



IA20WH
 IA20GR
 IA20RD
 IA20BL

- za indikacijo, signalizacijo ali stalno signalizacijo stikala
- v kombinaciji s tipko z indikatorjem

LED SIGNALLING UNIT 230V AC/DC 0,40W

- for indication, signalling or permanent signalling
- in combination with a button featuring an indicator

LED SIGNALIZACIJA 24V AC/DC 0,20W



IA21WH
 IA21RD

- za indikacijo, signalizacijo ali stalno signalizacijo stikala
- v kombinaciji s tipko z indikatorjem

LED SIGNALLING UNIT 24V AC/DC 0,20W

- for indication, signalling or permanent signalling
- in combination with a button featuring an indicator

LED SIGNALIZACIJA 12V AC/DC 0,10W

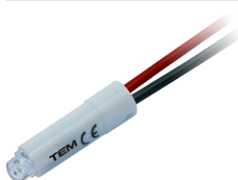

IA22WH
 IA22RD

- za indikacijo, signalizacijo ali stalno signalizacijo stikala
- v kombinaciji s tipko z indikatorjem

LED SIGNALLING UNIT 12V AC/DC 0,10W

- for indication, signalling or permanent signalling
- in combination with a button featuring an indicator

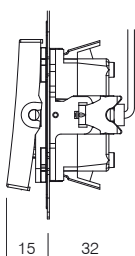

Indikacija /
Indication

*Signalizacija /
Signalization

Stalna signalizacija /
Permanent signalling

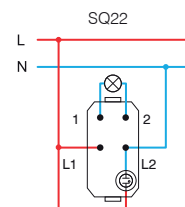
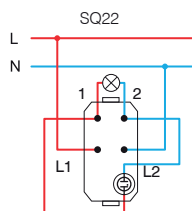
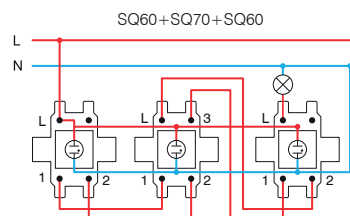
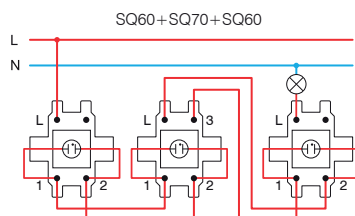
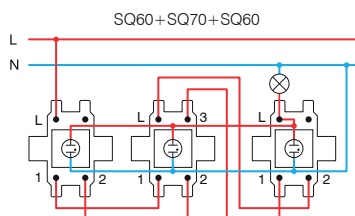
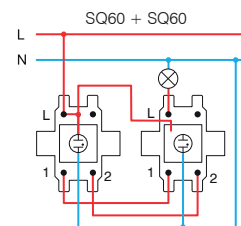
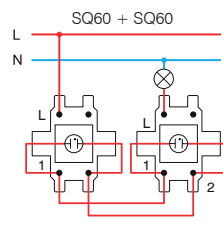
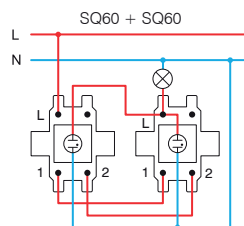
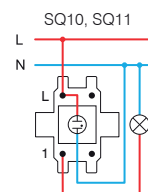
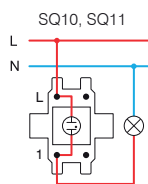
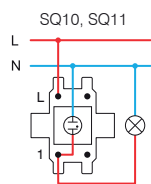

* vezave niso primerne za varčne (CFL, LED) sijalke /
the connections are not suitable for energy-saving bulbs (CFL, LED)

S O C K E T S V Q

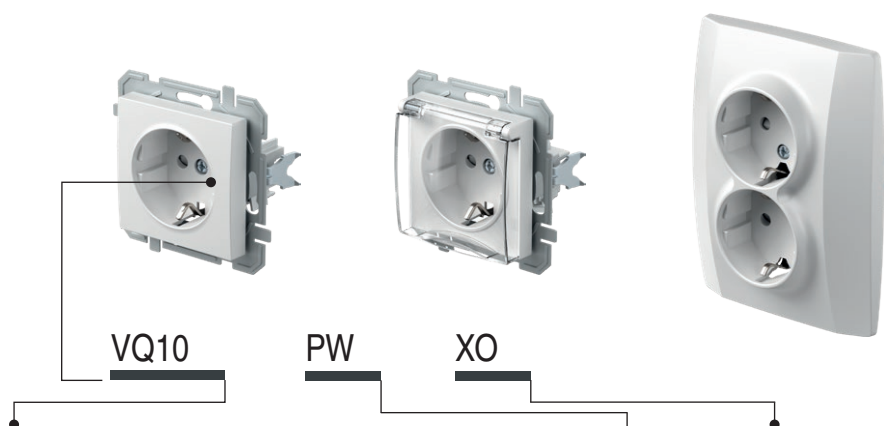

| tip type | naziv description | tehnični opis technical data | opsijski opis 1 optional data 1 |
|-------------|---|---------------------------------|--|
| VQ10 | VTIČNICA SCHUKO SOCKET SCHUKO | 2P+E 16A 250V~ | XO brez okvirja without cover plate |
| VQ11 | VTIČNICA SCHUKO+POKROV SOCKET SCHUKO+COVER | 2P+E 16A 250V~ | |
| VQ12 | VTIČNICA SCHUKO SOCKET SCHUKO | 2P+E 16A 250V~ BV | |
| : | : | : | |
| : | : | : | |

barva
colour

| | | | | | |
|----|-----------------------------|----|---|----|--|
| PW | bela - sijaj polar white | PT | bela+prozorna white+transparent | PP | bela+bela white+white |
| TI | titan titanium | TT | titan+prozorna titanium+transparent | TI | titan+titan titanium+titanium |
| AT | antracit anthracite | AT | antracit+prozorna anthracite+transparent | AA | antracit+antracit anthracite+anthracite |
| RD | rdeča red | RT | rdeča+prozorna red+transparent | RR | rdeča+rdeča red+red |
| GR | zelena green | GT | zelena+prozorna green+transparent | GG | zelena+zelena green+green |
| OR | oranžna orange | OT | oranžna+prozorna orange+transparent | OO | oranžna+oranžna orange+orange |



schuko - ustreza EN 60884-1, CEE7 (list III)

schuko - in accordance with EN 60884-1, CEE7 (standard sheet III)

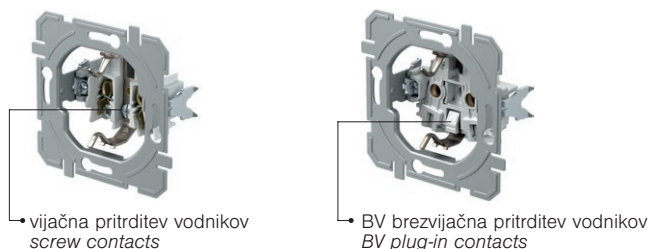

• vijajna pritržitev vodnikov
screw contacts

• BV brez vijajna pritržitev vodnikov
BV plug-in contacts

VITIČNICA SCHUKO 2P+E 16A 250V~ __ XO

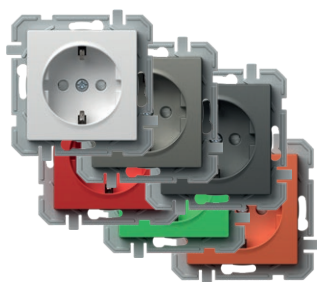

- VQ10PWXO
- VQ10TIXO
- VQ10ATXO
- VQ10RDXO
- VQ10GRXO
- VQ10ORXO

- vijajčna pritrditev vodnikov 1.5-2.5mm²
- XO brez okvirja
- 2P+E schuko
- 16A 250V~, tip VQ10
- vgrajena zaščita pred dotikom kontaktov



SOCKET SCHUKO 2P+E 16A 250V~ __ XO

- screw contacts 1.5-2.5mm²
- XO without surround
- 2P+E schuko
- 16A 250V~, type VQ10
- shuttered live contacts

VITIČNICA SCHUKO+POKROV 2P+E 16A 250V~ __ XO

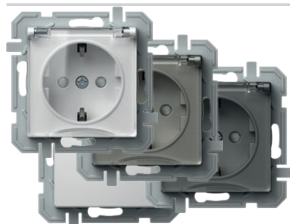

- VQ11PTXO
- VQ11TTXO
- VQ11ATXO
- VQ11PPXO

- vijajčna pritrditev vodnikov 1.5-2.5mm²
- XO brez okvirja
- 2P+E schuko+pokrov
- 16A 250V~, tip VQ11
- vgrajena zaščita pred dotikom kontaktov



SOCKET SCHUKO+COVER 2P+E 16A 250V~ __ XO

- screw contacts 1.5-2.5mm²
- XO without surround
- 2P+E schuko+cover
- 16A 250V~, type VQ11
- shuttered live contacts

VITIČNICA SCHUKO 2P+E 16A 250V~ BV __ XO

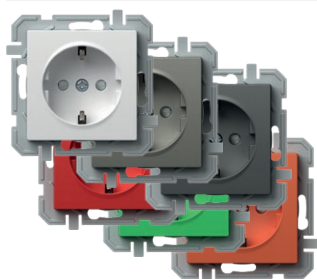

- VQ12PWXO
- VQ12TIXO
- VQ12ATXO
- VQ12RDXO
- VQ12GRXO
- VQ12ORXO

- BV brezvijajčna pritrditev vodnikov 1.5-2.5mm²
- XO brez okvirja
- 2P+E schuko
- 16A 250V~, tip VQ12
- vgrajena zaščita pred dotikom kontaktov



SOCKET SCHUKO 2P+E 16A 250V~ BV __ XO

- BV plug-in contacts 1.5-2.5mm²
- XO without surround
- 2P+E schuko
- 16A 250V~, type VQ12
- shuttered live contacts

VITIČNICA SCHUKO+POKROV 2P+E 16A 250V~ BV __ XO



- VQ13PTXO
- VQ13TTXO
- VQ13ATXO
- VQ13PPXO

- BV brezvijajčna pritrditev vodnikov 1.5-2.5mm²
- XO brez okvirja
- 2P+E schuko+pokrov
- 16A 250V~, tip VQ13
- vgrajena zaščita pred dotikom kontaktov



SOCKET SCHUKO+COVER 2P+E 16A 250V~ BV __ XO

- BV plug-in contacts 1.5-2.5mm²
- XO without surround
- 2P+E schuko+cover
- 16A 250V~, type VQ13
- shuttered live contacts

VITIČNICA SCHUKO DVOJNA 2P+E 16A 250V~



- VQ16PW
- VQ16TI
- VQ16AT

- 2P+E schuko dvojna
- 16A 250V~, tip VQ16
- ustreza IEC 60884-1, CEE7
- vijajčna pritrditev vodnikov 1.5-2.5 mm²
- vgrajena zaščita pred dotikom kontaktov



SOCKET SCHUKO DOUBLE 2P+E 16A 250V~

- 2P+E schuko double
- 16A 250V~, type VQ16
- in accordance with IEC 60884-1, CEE7
- screw contacts 1.5-2.5 mm²
- shuttered live contacts

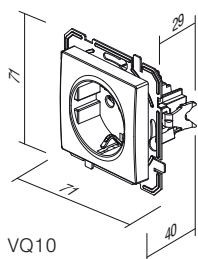

VQ10

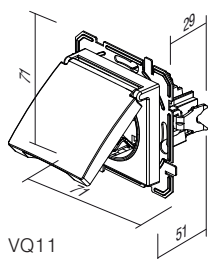

VQ11

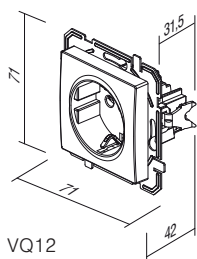

VQ12

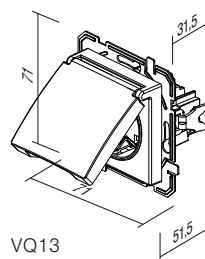

VQ13

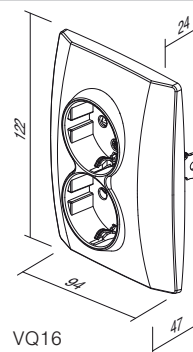

VQ16

S O C K E T S V Q



- VQ40PWXO
- VQ40TIXO
- VQ40ATXO
- VQ40RDXO
- VQ40GRXO
- VQ40ORXO

VTIČNICA FRANCOSKA 2P+E 16A 250V~ __ XO

- vijačna pritrditev vodnikov 1.5-2.5mm²
- XO brez okvirja
- 2P+E francoska
- 16A 250V~, tip VQ40
- vgrajena zaščita pred dotikom kontaktov



SOCKET FRENCH 2P+E 16A 250V~ __ XO

- screw contacts 1.5-2.5mm²
- XO without surround
- 2P+E French
- 16A 250V~, type VQ40
- shuttered live contacts



- VQ41PTXO
- VQ41TTXO
- VQ41ATXO
- VQ41PPXO

VTIČNICA FRANCOSKA+POKROV 2P+E 16A 250V~ __ XO

- vijačna pritrditev vodnikov 1.5-2.5mm²
- XO brez okvirja
- 2P+E francoska+pokrov
- 16A 250V~, tip VQ41
- vgrajena zaščita pred dotikom kontaktov



SOCKET FRENCH+COVER 2P+E 16A 250V~ __ XO

- screw contacts 1.5-2.5mm²
- XO without surround
- 2P+E French+cover
- 16A 250V~, type VQ41
- shuttered live contacts



- VQ42PWXO
- VQ42TIXO
- VQ42ATXO

VTIČNICA FRANCOSKA 2P+E 16A 250V~ BV __ XO

- BV brezvijačna pritrditev vodnikov 1.5-2.5mm²
- XO brez okvirja
- 2P+E francoska
- 16A 250V~, tip VQ42
- vgrajena zaščita pred dotikom kontaktov



SOCKET FRENCH 2P+E 16A 250V~ BV __ XO

- BV plug-in contacts 1.5-2.5mm²
- XO without surround
- 2P+E French
- 16A 250V~, type VQ42
- shuttered live contacts



- VQ43PTXO
- VQ43TTXO
- VQ43ATXO
- VQ43PPXO

VTIČNICA FRANCOSKA+POKROV 2P+E 16A 250V~ BV __ XO

- BV brezvijačna pritrditev vodnikov 1.5-2.5mm²
- XO brez okvirja
- 2P+E francoska+pokrov
- 16A 250V~, tip VQ43
- vgrajena zaščita pred dotikom kontaktov



SOCKET FRENCH+COVER 2P+E 16A 250V~ BV __ XO

- BV plug-in contacts 1.5-2.5mm²
- XO without surround
- 2P+E French+cover
- 16A 250V~, type VQ43
- shuttered live contacts



- VQ46PWXO
- VQ46TIXO
- VQ46ATXO

VTIČNICA FRANCOSKA DVOJNA 2P+E 16A 250V~

- 2P+E francoska dvojna
- 16A 250V~, tip VQ46
- ustreza IEC 60884-1, CEE7; NF C 61-314, ČSN 33 2318; PN-E 93201
- vijačna pritrditev vodnikov 1,5-2,5 mm²
- vgrajena zaščita pred dotikom kontaktov



SOCKET FRENCH DOUBLE 2P+E 16A 250V~

- 2P+E French double
- 16A 250V~, type VQ46
- in accordance with IEC 60884-1, CEE7; NF C 61-314, ČSN 33 2318; PN-E 93201
- screw contacts 1,5-2,5 mm²
- shuttered live contacts

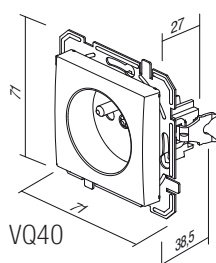

VQ40

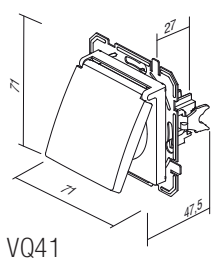

VQ41

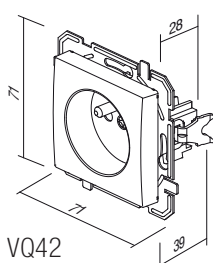

VQ42

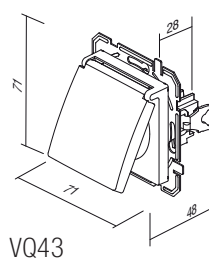

VQ43

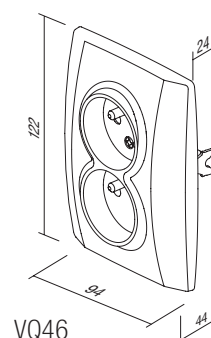

VQ46

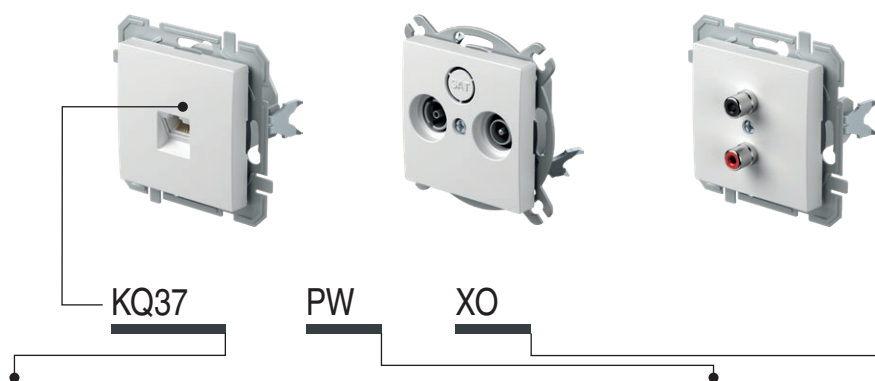

| tip type | naziv description | tehnični opis technical data | barva colour | opcijski opis 1 optional data 1 |
|-------------|--|---------------------------------|---|--|
| KQ11 | VTIČNICA TV-R KONČNA SOCKET TV-R END-LINE | 1dB | <input type="checkbox"/> PW bela - sijaj polar white | XO brez okvirja without cover plate |
| KQ12 | VTIČNICA TV-R PREHODNA SOCKET TV-R THROUGHPASS | 10dB | <input type="checkbox"/> TI titan titanium | |
| KQ16 | VTIČNICA SAT-TV-R KONČNA SOCKET SAT-TV-R END-LINE | 3dB | <input type="checkbox"/> AT antracit anthracite | |
| ... | ... | ... | | |

VTIČNICA TV OSNOVNA 0dB



- KQ10PWXO
- KQ10TIXO
- KQ10ATXO

- TV osnovna
- dušenje 0dB
- konektor zadaj – F standard

SOCKET TV BASIC 0dB

- TV basic
- reduction 0dB
- back connector – F standard



VTIČNICA TV-R KONČNA 1dB



- KQ11PWXO
- KQ11TIXO
- KQ11ATXO

- TV-R končna
- frekvenčni pas 5÷862 MHz
- dušenje: R-1.5dB, TV-1dB
- ustreza EN 50083-1
- vijajna priključitev

SOCKET TV-R END-LINE 1dB

- TV-R end-line
- frequency range 5÷862 MHz
- reduction: R-1.5dB, TV-1dB
- in accordance with EN 50083-1
- screw contact



VTIČNICA TV-R PREHODNA 10dB



- KQ12PWXO
- KQ12TIXO
- KQ12ATXO

- TV-R prehodna
- frekvenčni pas 5÷862 MHz
- dušenje: R-10dB, TV-10dB, prehod-2dB
- ustreza EN 50083-1
- vijajna priključitev

SOCKET TV-R TROUGHPASS 10dB

- TV-R troughpass
- frequency range 5÷862 MHz
- reduction: R-10dB, TV-10dB, trough-2dB
- in accordance with EN 50083-1
- screw contacts



VTIČNICA SAT-TV-R KONČNA 3dB



- KQ16PWXO
- KQ16TIXO
- KQ16ATXO

- SAT-TV-R končna
- frekvenčni pas 5÷2400 MHz
- dušenje: R-1dB, TV-1.5dB, SAT-3dB
- ustreza EN 50083-1
- vijajna priključitev

SOCKET SAT-TV-R END-LINE 3dB

- SAT-TV-R end-line
- frequency range 5÷2400 MHz
- reduction: R-1dB, TV-1.5dB, SAT-3dB
- in accordance with EN 50083-1
- screw contacts



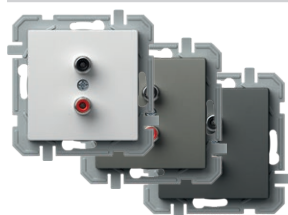

- KQ22PWXO
- KQ22TIXO
- KQ22ATXO

VTIČNICA AVDIO 2xRCA

- avdio 2xRCA
- pritrditev vodnikov s spajkanjem

SOCKET AUDIO 2xRCA

- audio 2xRCA
- soldering connection of cable



- KQ23PWXO
- KQ23TIXO
- KQ23ATXO

VTIČNICA AVDIO ZVOČNIŠKA

- avdio 2x Ø4mm
- za priklp zvočniškega vodnika, vtiča Ø4mm ali viličastega kabel čevlja
- pritrditev vodnikov zadaj s spajkanjem

SOCKET AUDIO LOUDSPEAKERS

- audio 2x Ø4mm
- to accommodate speaker wire, banana plug Ø4mm or spades
- soldering connection of cable at the back side

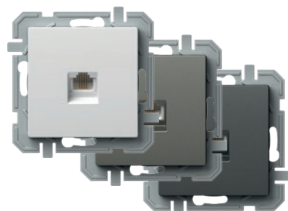

- KQ36PWXO
- KQ36TIXO
- KQ36ATXO

VTIČNICA TEL KS RJ11 6/4

- KS keystone pritrditveni standard
- RJ11 6/4
- ustreza IEC 60603-7

SOCKET TEL KS RJ11 6/4

- KS keystone fixing standard
- RJ11 6/4
- in accordance with IEC 60603-7

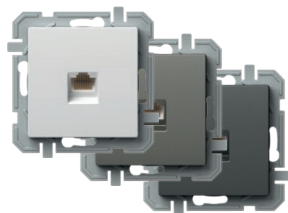

- KQ37PWXO
- KQ37TIXO
- KQ37ATXO

VTIČNICA CAT5e KS RJ45 8/8

- KS keystone pritrditveni standard
- CAT5e, RJ45 8/8
- ustreza IEC 60603-7

SOCKET CAT5e KS RJ45 8/8

- KS keystone fixing standard
- CAT5e, RJ45 8/8
- in accordance with IEC 60603-7

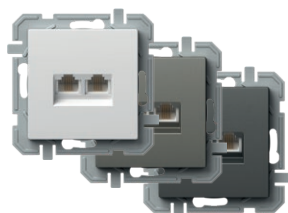

- KQ38PWXO
- KQ38TIXO
- KQ38ATXO

VTIČNICA TEL KS DVOJNA 2x RJ11 6/4

- KS keystone pritrditveni standard
- 2x RJ11, 6/4
- ustreza IEC 60603-7

SOCKET TEL KS DOUBLE 2x RJ11 6/4

- KS keystone fixing standard
- 2x RJ11, 6/4
- in accordance with IEC 60603-7

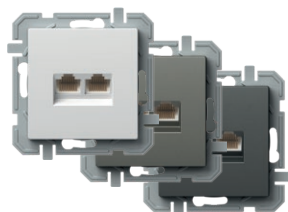

- KQ39PWXO
- KQ39TIXO
- KQ39ATXO

VTIČNICA CAT5e KS DVOJNA 2x RJ45 8/8

- KS keystone pritrditveni standard
- 2x CAT5e, RJ45 8/8
- ustreza IEC 60603-7

SOCKET CAT5e KS DOUBLE 2x RJ45 8/8

- KS keystone fixing standard
- 2x CAT5e, RJ45 8/8
- in accordance with IEC 60603-7

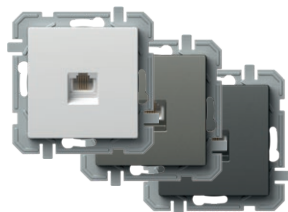

- KQ35PWXO
- KQ35TIXO
- KQ35ATXO

VTIČNICA TEL LT RJ11 6/4

- TEL LT vijak
- vijačna pritrditev vodnikov
- RJ11 6/4
- ustreza IEC 60603-7

SOCKET TEL LT RJ11 6/4

- TEL LT screw
- screw contacts
- RJ11 6/4
- in accordance with IEC 60603-7



VTIČNICA CAT6s KS RJ45 8/8 SLIM



- KQ40PWXO
- KQ40TIXO
- KQ40ATXO

- KS keystone pritrditveni standard
 - CAT6s, RJ45 8/8
 - ustreza IEC 60603-7

SOCKET CAT6s KS RJ45 8/8 SLIM

- KS keystone fixing standard
 - CAT6s, RJ45 8/8
 - in accordance with IEC 60603-7



VTIČNICA CAT6s KS DVOJNA 2x RJ45 8/8 SLIM

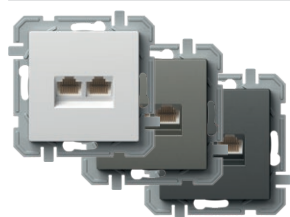

- KQ41PWXO
- KQ41TIXO
- KQ41ATXO

- KS keystone pritrditveni standard
 - 2xCAT6, RJ45 8/8
 - ustreza IEC 60603-7

SOCKET CAT6s KS DOUBLE 2x RJ45 8/8 SLIM

- KS keystone fixing standard
 - 2x CAT6s, RJ45 8/8
 - in accordance with IEC 60603-7

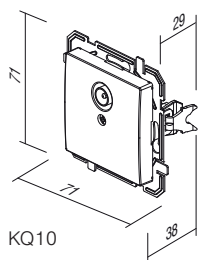

KQ10

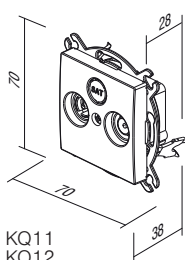

KQ11
KQ12

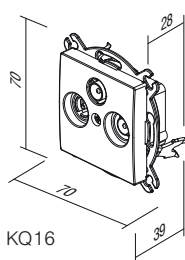

KQ16

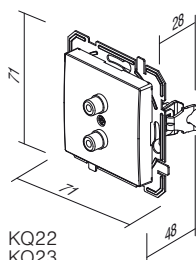

KQ22
KQ23

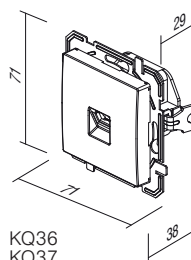

KQ36
KQ37
KQ35
KQ40

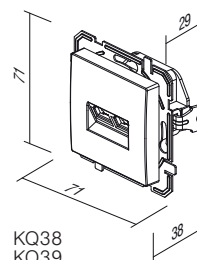

KQ38
KQ39
KQ41



EQ15

PW

XO

| tip type | naziv description | tehnični opis technical data | barva colour | opsijski opis 1 optional data 1 |
|-------------|--|---------------------------------|----------------------------------|--|
| EQ15 | ZATEMNILNIK ROTACIJSKI MEN DIMMER ROTATIVE 2WAY | RL 400W | □ PW bela - sijaj polar white | XO brez okvirja without cover plate |
| EQ16 | ZATEMNILNIK ROTACIJSKI MEN DIMMER ROTATIVE 2WAY | RLC 400W | ■ TI titan titanium | |
| EQ19 | ZATEMNILNIK ROTACIJSKI MEN DIMMER ROTATIVE 2WAY | LED 100W | ■ AT antracit anthracite | |
| ⋮ | ⋮ | ⋮ | | |

ZATEMNILNIK ROTACIJSKI MEN RL 400W

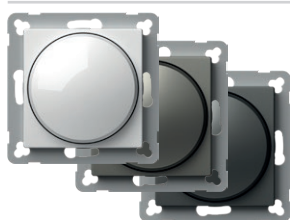

- EQ15PWXO
- EQ15TIXO
- EQ15ATXO

- rotacijski z menjalnim stikala
- breme RL, 40W - 400W
- možna vezava z menjalnim stikalom
- vezava več zatemnilnikov ni dovoljena
- ustreza EN 60669-1 in EN 60669-2-1
- brezvijačna pritrditev vodnikov 1.5mm²
- napajanje 230V[~] 50Hz
- zamenljiva varovalka vključena



DIMMER ROTATIVE 2WAY RL 400W

- rotation control with 2-way switch
- load RL, 40W - 400W
- 2-way switch combination is possible
- more dimmers combination is not allowed
- in accordance with EN 60669-1 and EN 60669-2-1
- plug-in contacts 1.5mm²
- supply 230V[~] 50Hz
- replaceable fuse included

ZATEMNILNIK ROTACIJSKI MEN RLC 400W

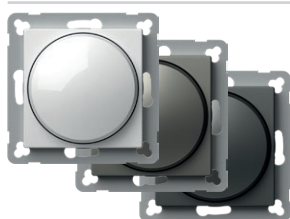

- EQ16PWXO
- EQ16TIXO
- EQ16ATXO

- rotacijski z menjalnim stikalom
- breme RLC, 20W - 400W
- možna vezava z menjalnim stikalom
- vezava več zatemnilnikov ni dovoljena
- ustreza EN 60669-1 in EN 60669-2-1
- brezvijačna pritrditev vodnikov 1.5mm²
- napajanje 230V[~] 50Hz
- elektronska varovalka



DIMMER ROTATIVE 2WAY RLC 400W

- rotation control with 2-way switch
- load RLC, 20W - 400W
- 2-way switch combination is possible
- more dimmers combination is not allowed
- in accordance with EN 60669-1 and EN 60669-2-1
- plug-in contacts 1.5mm²
- supply 230V[~] 50Hz
- electronic fuse

ZATEMNILNIK ROTACIJSKI MEN LED 100W



- EQ19PWXO
- EQ19TIXO
- EQ19ATXO

- rotacijski z menjalnim stikalom
- breme: LED, 0-100W (max. 10 LED sijalk)
GLS, 10-250W
- možna vezava z menjalnim stikalom
- vezava več zatemnilnikov ni dovoljena
- ustreza EN 60669-1 in EN 60669-2-1
- brezvijačna pritrditev vodnikov 1,5 mm²
- napajanje 230V[~] 50 Hz
- zamenljiva varovalka vključena



DIMMER ROTATIVE 2WAY LED 100W

- rotation control with 2-way switch
- load: LED, 0-100W (max. 10 LEDs)
GLS, 10-250W
- 2-way switch combination is possible
- more dimmers combination is not allowed
- in accordance with EN 60669-1 and EN 60669-2-1
- plug-in contacts 1.5mm²
- supply 230V[~] 50Hz
- replaceable fuse included

EQ15, EQ16, EQ19

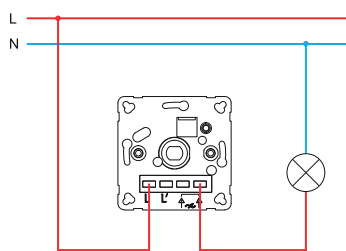

EQ15, EQ16, EQ19

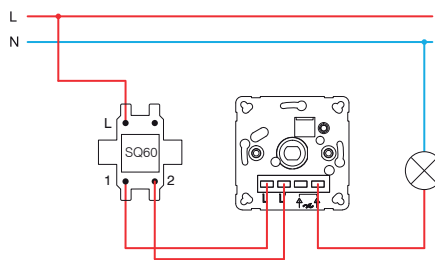

EQ15, EQ16, EQ19

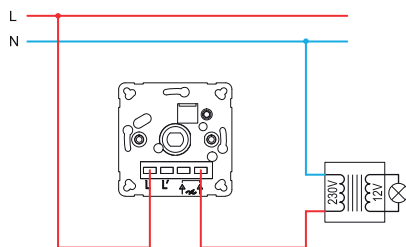

EQ15, EQ16, EQ19

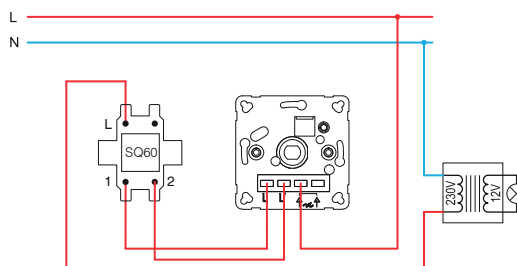

EQ16, EQ19

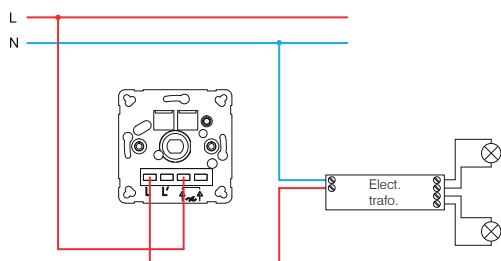

EQ16, EQ19

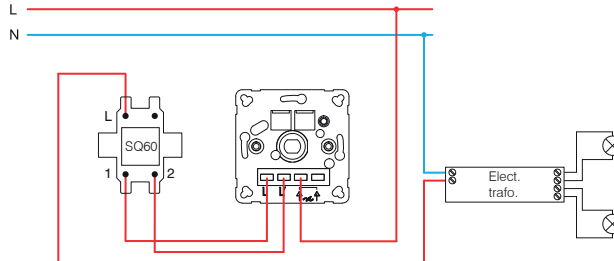

EQ15 (40÷400W)

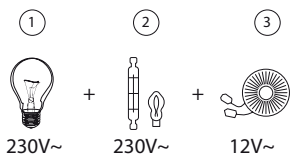

- 1 - žarnica z žarilno nitko / incandescent lamp
- 2 - halogenska žarnica / halogen lamp

EQ16 (20÷400W)

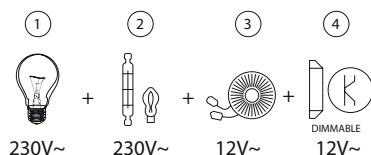

- 3 - klasični transformator / classical transformer
- 4 - zatemnilni el. transformator / dimmable electronic transformer

EQ19 (GLS 10÷250W ; LED 0÷100W)

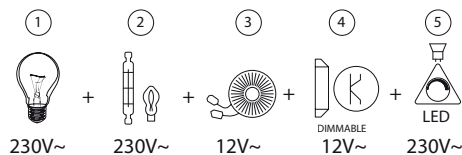

- 5 - zatemnilna LED sijalka / dimmable LED lamp



- EQ32PWXO
- EQ32TIXO
- EQ32ATXO

IR STIKALO 5A 230V~

- IR infrardeče stikalo
- napajanje: 230V~ ±10 % 50Hz
- rele: 5A / 250V~ zero crossing
- stopnja varnosti: IP40
- preseki žic pri stičniku: 0,75 - 2,5 mm²
- kot zaznavanja: do 110° pri 20°C
- območje zaznavanja: približno 8 m pri 20°C
- nastaviteljivost časovnega trajanja: od približno 5 s do 12 min
- nastaviteljivost osvetlitve: od približno 5 do 200 LUX
- temperatura delovanja: od 0°C do +40°C
- ni primeren za vgradnjo v doze, globine 45 mm
- samo za notranjo uporabo

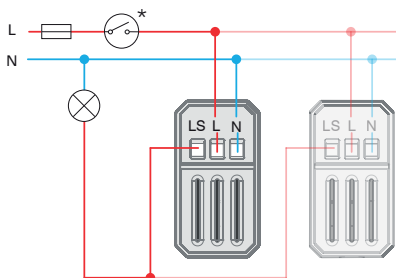

IR SWITCH 5A 230V~

- IR infrared switch
- supply voltage: 230V~ ±10 % 50Hz
- relay: 5A / 250V~ output for limited current with high resistance for zero crossing
- protection rating: IP40
- cross-section of wires at the contact terminal: 0.75 - 2.5 mm²
- detection angle: up to 110° at 20°C
- detection area: approx. 8 m at 20°C
- adjustability of duration: from approx. 5 s to 12 min
- adjustability of brightness: from approx. 5 to 200 LUX
- operating temperature: from 0°C to +40°C
- not suitable for installation in 45 mm deep boxes
- only for indoor usage

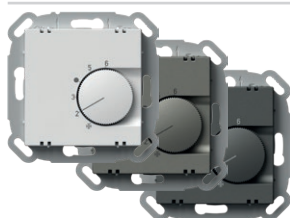

- EQ35PWXO
- EQ35TIXO
- EQ35ATXO

THERMOSTAT OGREVANJE 10A 230V~

- način delovanja: ogrevanje
- napajanje: 230 V~, 50 Hz
- izhod: 4 A (max. 10 A), 230 V~, 50 Hz
- izhodni priključek: NO (max. 10 aktuatorjev)
- območje regulacije: +5 °C do +30 °C
- histereza: 0,5 K
- zaščita: IP30
- vrsta tipala: bimetal
- vrsta električnega priključka: vzmetni kontakti
- vrsta vodnikov: 0,75 - 1,5mm² (mehko-žilni) ali 1,0 - 2,5 mm² (trdo-žilni)

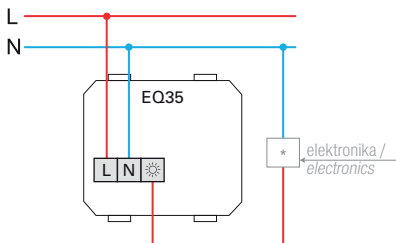

THERMOSTAT HEATING 10A 230V~

- operation mode: heating
- power supply: 230 V~, 50 Hz
- output: 4 A (max. 10 A), 230 V~, 50 Hz
- switching contact: NC (max. 10 actuators)
- regulation range: +5 °C to +30 °C
- hysteresis: 0,5 K
- protection: IP30
- sensor type: bimetal
- type of electrical connection: spring-loaded contacts
- type of conductors: 0,75 - 1,5mm² (flexible-stranded core) or 1,0 - 2,5 mm² (solid core)

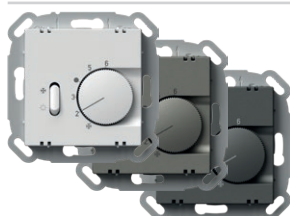

- EQ36PWXO
- EQ36TIXO
- EQ36ATXO

THERMOSTAT OGREVANJE / HLAJENJE 5A 230V~

- način delovanja: ogrevanje / hlajenje
- napajanje: 230 V~, 50 Hz
- izhod: 2 A (max. 5 A), 230 V~, 50 Hz
- izhodni priključek: preklopno stikalo (max. 5 aktuatorjev)
- območje regulacije: +5 °C do +30 °C
- histereza: 0,5 K
- zaščita: IP30
- vrsta tipala: bimetal
- vrsta električnega priključka: vzmetni kontakti
- vrsta vodnikov: 0,75 - 1,5mm² (mehko-žilni) ali 1,0 - 2,5 mm² (trdo-žilni)

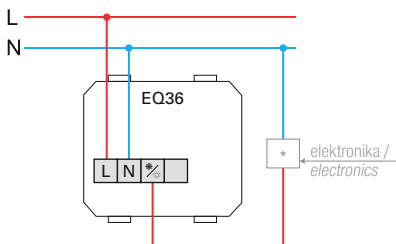

THERMOSTAT HEATING / COOLING 5A 230V~

- operation mode: heating / cooling
- power supply: 230 V~, 50 Hz
- output: 2 A (max. 5 A), 230 V~, 50 Hz
- switching contact: changeover switch (toggler, max. 5 actuators)
- regulation range: +5 °C to +30 °C
- hysteresis: 0,5 K
- protection: IP30
- sensor type: bimetal
- type of electrical connection: spring-loaded contacts
- type of conductors: 0,75 - 1,5mm² (flexible-stranded core) or 1,0 - 2,5 mm² (solid core)

TERMOSTAT TALNO OGREVANJE 16A 230V~

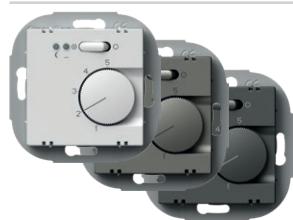

- EQ37PWXO
- EQ37TIXO
- EQ37ATXO

- način delovanja: talno ogrevanje
- napajanje: 230 V~, 50 Hz
- izhod: 2 A (max. 16 A), 230 V~, 50 Hz
- območje regulacije: +10 °C do +50 °C
- histereza: 1 K
- zaščita: IP30
- vrsta tipala: NTC v skladu z DIN EN 60730-2-1
- indikatorji:
 - rdeča LED za ogrevanje in
 - zelena LED za nočni zmanjšani način
- vrsta električnega priključka: vijaki kontakti
- vrsta vodnikov: 0,5 – 2,5 mm²

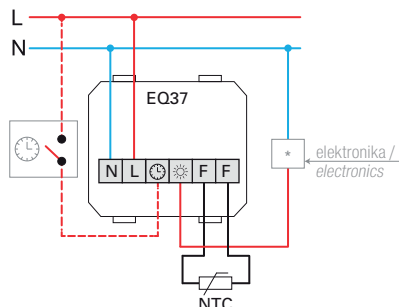

THERMOSTAT FLOOR HEATING 16A 230V~

- operation mode: floor heating
- power supply: 230 V~, 50 Hz
- output: 2 A (max. 16 A), 230 V~, 50 Hz
- regulation range: +10 °C to +50 °C
- hysteresis: 1 K
- protection: IP30
- sensor type: NTC in compliance with DIN EN 60730-2-1
- indicators: Red LED for heating and green LED for night decrease mode
- type of electrical connection: Screw contacts
- type of conductors: 0,5 – 2,5mm²

POLNILNIK USB 5V 3,0A



- EQ68PWXO
- EQ68TIXO
- EQ68ATXO

- za polnjenje elektronskih naprav prek standardnega USB priključka (kompatibilno tudi z Apple napravami)
- napajanje: 100-230 V~ 50/60 Hz
- poraba med delovanjem:
 - 300 mA pri 100 V~/150 mA pri 230 V~
- poraba v mirovanju: 30 mW pri 230 V~
- izhodna napetost: 5 VDC (±5 %) SELV
- nihanje izhodne napetosti: 150 mV
- nominalni izhodni tok: 3,0 A (±10 %)
- tip konektorja: USB A / USB C
- učinkovitost: maksimalno 77 %
- temperatura delovanja: 0 °C/+ 45 °C (notranja uporaba)
- IP zaščitni razred: IP20, samo za notranjo uporabo
- varnostni razred naprave II
- prenapetostna zaščita (EN 62109): razred III
- vijakna pritrditev vodnikov max. 2.5 mm²
- naprava z odmikom kontaktov min. 3 mm
- ustreza standardu EN 60950-1 in direktivam EMC in LVD



USB POWER SUPPLY UNIT 5V 3.0A

- for charging electronic devices via a standard USB port (also compatible with Apple devices)
- power supply: 100-230V~ 50/60Hz
- power consumption: 300mA at 100V~/150mA at 230V~
- standby power consumption: 30mW at 230V~
- nominal output voltage: 5 VCD (± 5%) SELV
- output ripple voltage: 150mV
- nominal output current: 3.0 A (±10%)
- connector type: USB A / USB C
- efficiency: maximum of 77%
- operating temperature: 0°C/+45°C (indoor use)
- IP protection class: IP20, indoor use only
- class device II
- overvoltage category (EN 62109): Class III
- screw contacts: max. 2.5 mm²
- device with a contact gap of at least 3mm
- in accordance with the EN 60950-1 and LVD & EMC directives

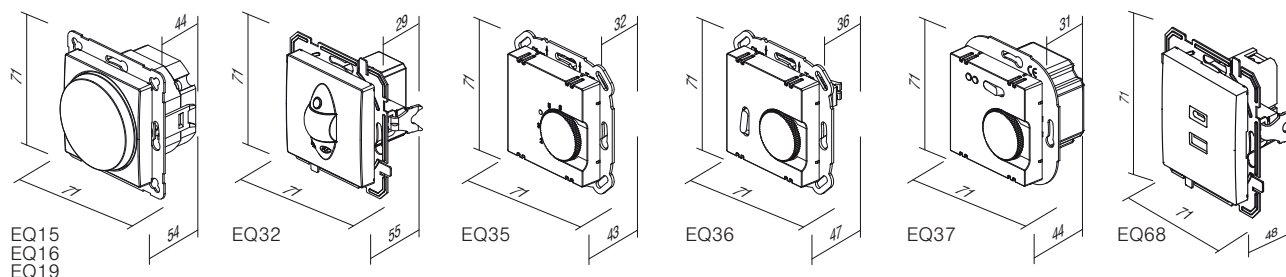

A C C E S S O R I E S P Q

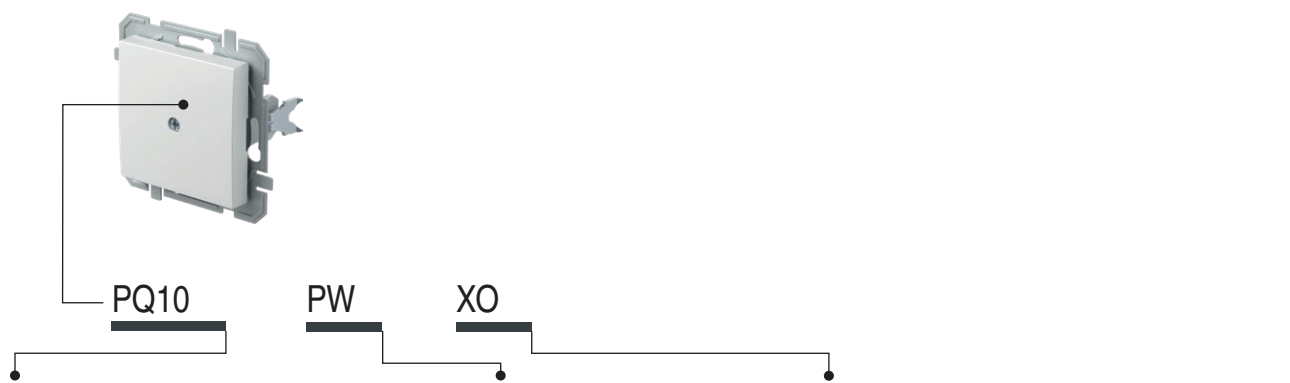

| tip type | naziv description | barva colour | opcijski opis 1 optional data 1 |
|-------------|---------------------------------|---|--|
| PQ10 | POLNILO BLANK | □ PW bela - sijaj polar white | XO brez okvirja without cover plate |
| PQ30 | POKROV TAE/TDO COVER TAE/TDO | ■ TI titan titanium ■ AT antracit anthracite | |

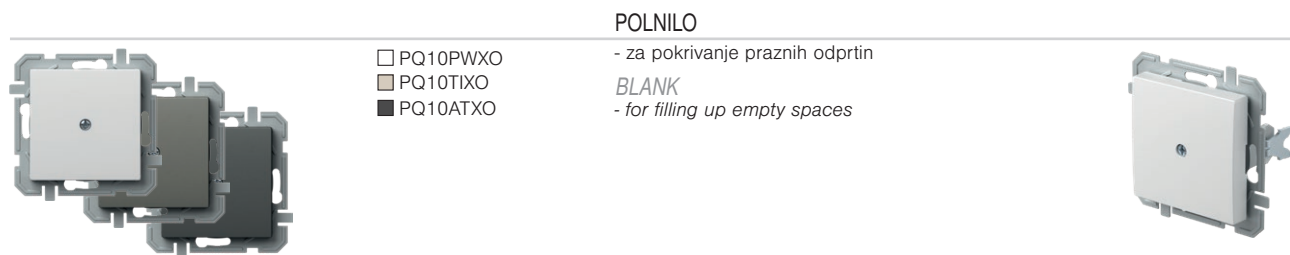

POLNILO

- za pokrivanje praznih odprtin

BLANK

- for filling up empty spaces

- PQ10PWXO
- PQ10TIXO
- PQ10ATXO



POKROV TAE/TDO

- TAE ali TDO pokrov z vijakom

COVER TAE/TDO

- TAE or TDO cover with screw

- PQ30PW
- PQ30TI
- PQ30AT

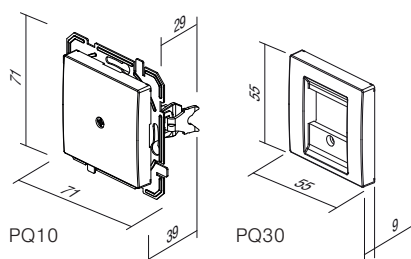

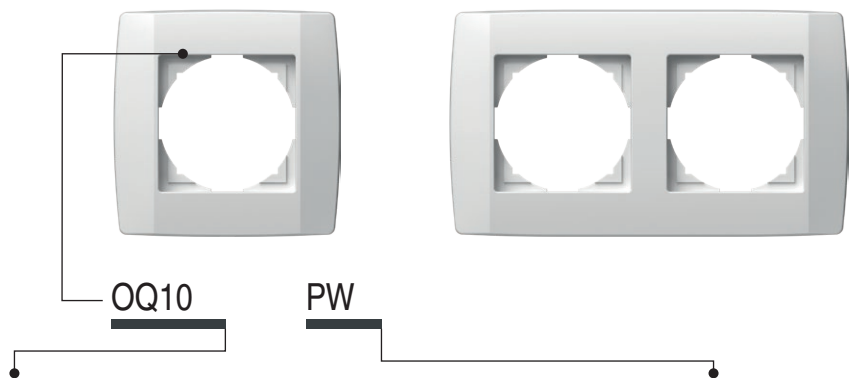

| tip type | naziv description | barva colour |
|-------------|--------------------------------------|--------------------------------|
| OQ10 | OKVIR LOGIQ 1 COVER PLATE LOGIQ 1 | PW bela - sijaj polar white |
| OQ20 | OKVIR LOGIQ 2 COVER PLATE LOGIQ 2 | TI titan titanium |
| OQ30 | OKVIR LOGIQ 3 COVER PLATE LOGIQ 3 | AT antracit anthracite |
| : | : | : |



- OQ10PW
- OQ10TI
- OQ10AT

OKVIR LOGIQ 1

- dekorativni enojni okvir
- ustreza EN 60669-1
COVER PLATE LOGIQ 1
- decorative cover plate 1-gang
- in accordance with EN 60669-1

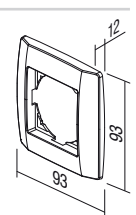

- OQ20PW
- OQ20TI
- OQ20AT

OKVIR LOGIQ 2

- dekorativni dvojni okvir
- ustreza EN 60669-1
COVER PLATE LOGIQ 2
- decorative cover plate 2-gang
- in accordance with EN 60669-1

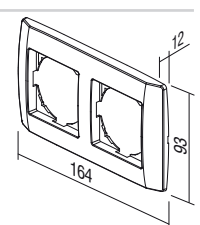

C O V E R P L A T E S O Q



OQ30PW
 OQ30TI
 OQ30AT

OKVIR LOGIQ 3

- dekorativni trojni okvir
- ustreza EN 60669-1

COVER PLATE LOGIQ 3
- decorative cover plate 3-gang
- in accordance with EN 60669-1

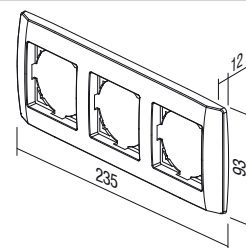

OQ40PW
 OQ40TI
 OQ40AT

OKVIR LOGIQ 4

- dekorativni četvorni okvir
- ustreza EN 60669-1

COVER PLATE LOGIQ 4
- decorative cover plate 4-gang
- in accordance with EN 60669-1

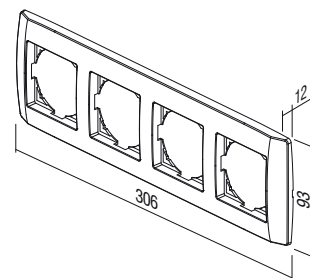

OQ50PW
 OQ50TI
 OQ50AT

OKVIR LOGIQ 5

- dekorativni 5-mestni okvir
- ustreza EN 60669-1

COVER PLATE LOGIQ 5
- decorative cover plate 5-gang
- in accordance with EN 60669-1

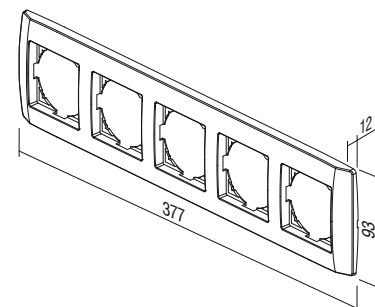

TEM

ekonomik





ekonomik

NAČRTOVANO ZA ODLIČNOST **Bistven je slog**

Nevtralen, kompakten, eleganten dizajn se prilagodi v vsako okolje, v katerem bivate ali delate. V interierju ne izstopa, temveč z njim harmonično zaživi.

PLANNED FOR EXCELLENCE **Style is essential**

A neutral, compact, elegant design is adjustable to every working or living area. It does not stick out from the interior, but rather harmonically fits into it.





ekonomik

HARMONIJA BARV Izberi svoj odtenek

Želje so različne. Zato smo za vas pozorno izbrali možnosti, ki vam nudijo pravi odgovor. Nevtralna paleta barv bo le dopolnila vaš ambient - ne bo vas omejevala.

HARMONY OF COLOURS Choose your hue

Desires can be very different. Therefore we have carefully selected possibilities for you, which can offer you the right answer. A neutral palette of colours will only complement your ambient - it will not restrict it.

| | | |
|-----------------------------|-----------------------|------------------------|
| <input type="checkbox"/> PW | bela-sijaj | <i>polar white</i> |
| <input type="checkbox"/> IW | bež-sijaj | <i>ivory white</i> |
| <input type="checkbox"/> ES | srebrna-mat | <i>elox silver</i> |
| <input type="checkbox"/> CO | beli duroplast | <i>white thermoset</i> |
| <input type="checkbox"/> NB | črna sijaj | <i>night black</i> |



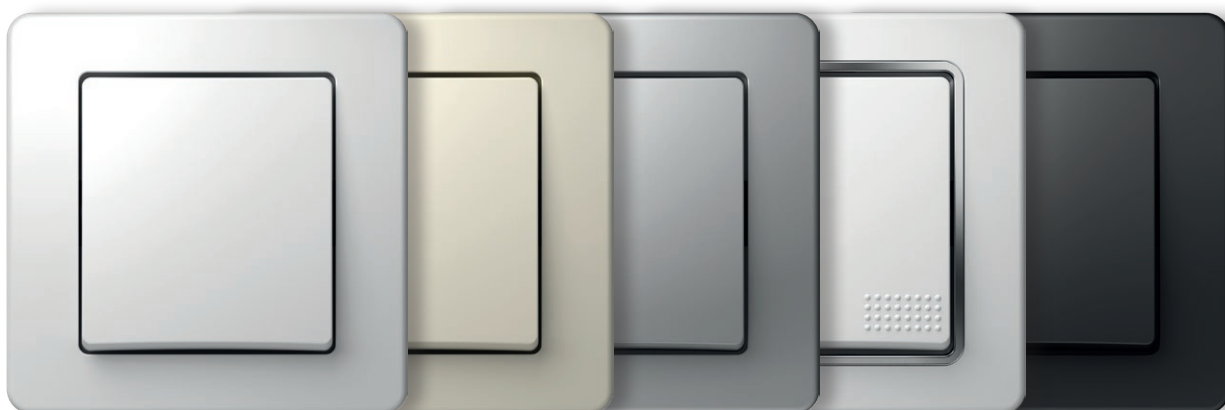

PREPROSTO ZA NAJZAHTEVNEJŠE

S skrbnim načrtovanjem smo poskrbeli, da so elementi pod napetostjo zaščiteni pred dotikom. Osnovno pritrjevanje mehanizmov s krepeljci (1) lahko dodatno utrdite z vijaki (2). Ta način je še posebej primeren za varno in zanesljivo pritrnitev vtičnice.

SIMPLE FOR THE MOST DEMANDING

By careful planning elements under voltage have been protected against touching. Basic fixing of mechanisms with fixing claws (1) allows additional strengthening with screws (2). This manner is especially appropriate for safe and reliable fixing of sockets.

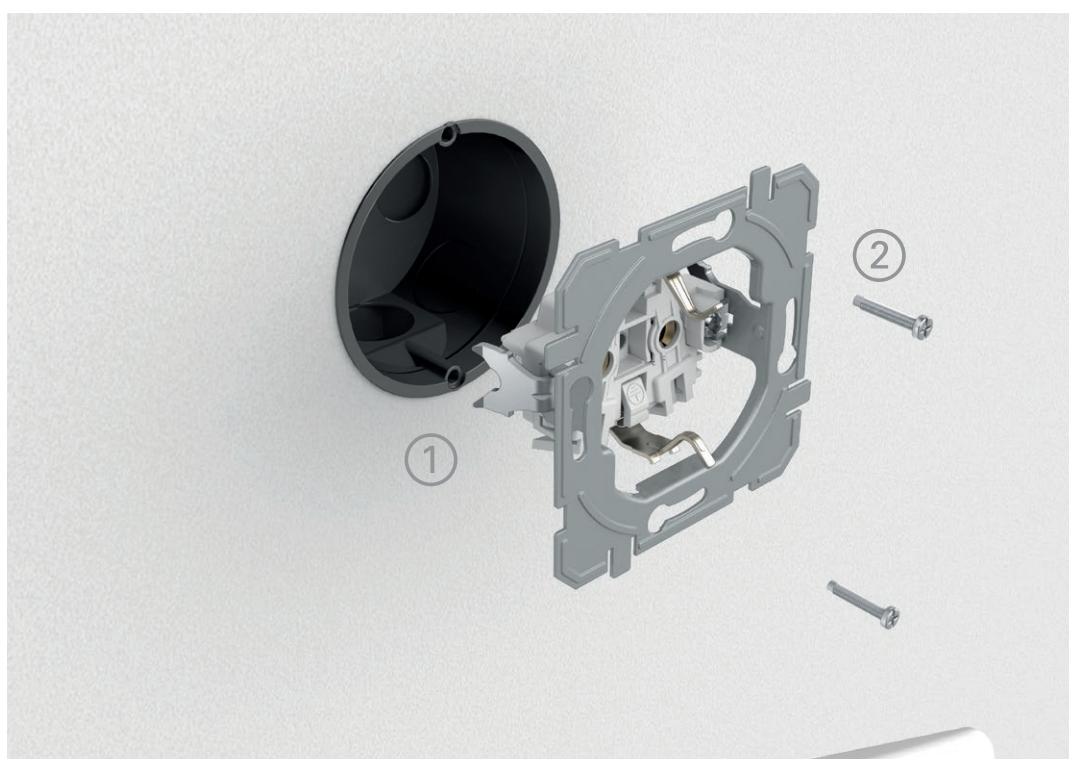

KOMBINIRAJTE KOT SAMI ŽELITE.

COMBINE AS YOU PLEASE.



S sestavljanjem prihranite prostor na steni.
Ko imate malo prostora, je navpično prava
odločitev.

With combining you save space on the wall.
When faced with a limited space, »vertically«
is the right decision.

ENOSTAVNA MONTAŽA

Ekonomik je rešitev za sistem standardnih okroglih doz. Z njim lahko načrtujete tako enostavne kot tudi zahtevnejše inštalacije, novogradnje in adaptacije. Sistem odlikujejo brezvijačni kontakti, ki vam prihranijo čas pri vgradnji elementov.

EASY INSTALLATION

Ekonomik is a solution for the system of standardized round installations boxes. It can be used for simple as well as more demanding installations, new buildings and adaptations. The system is characterised by plug-in contacts which save time during installation of elements.

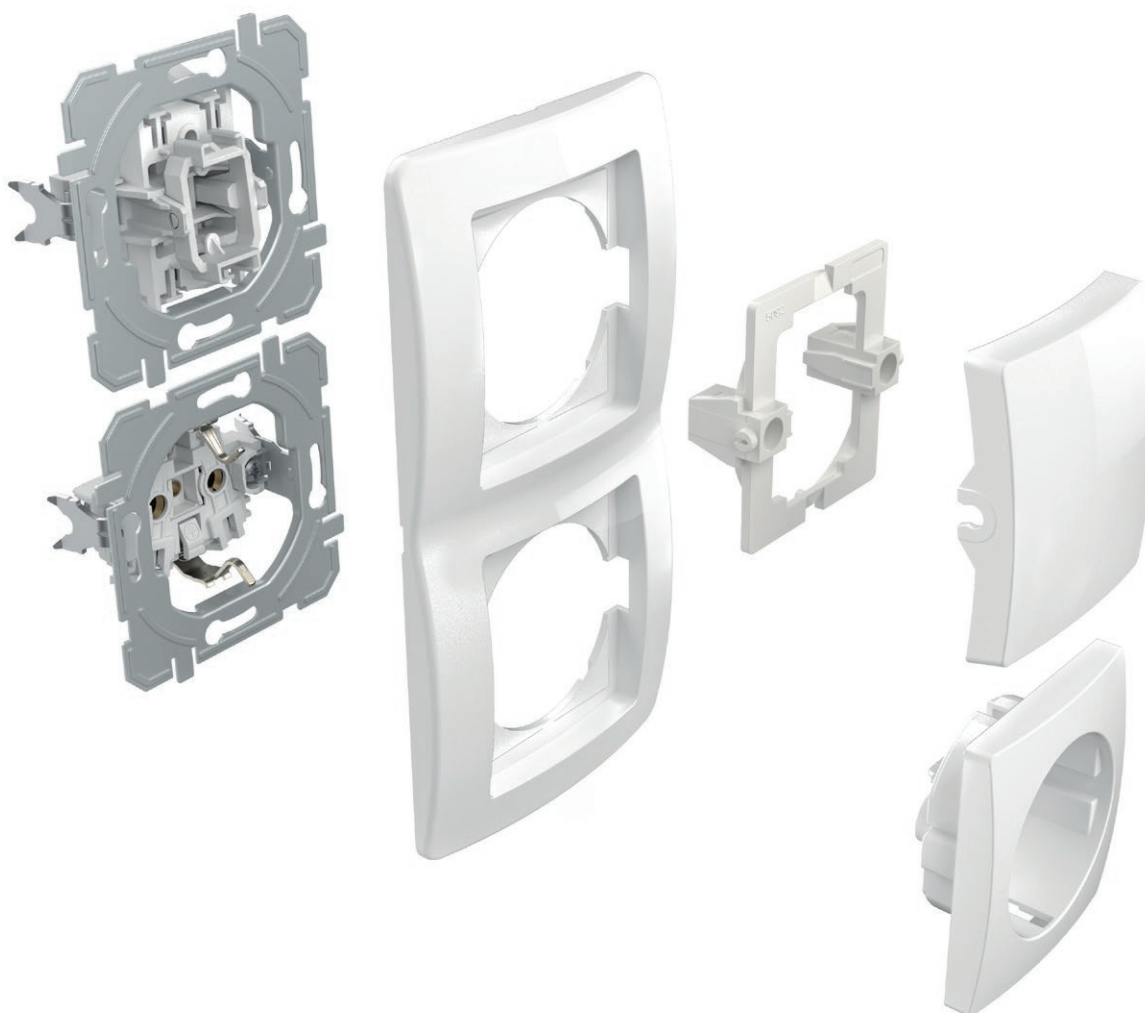

DOBRO JE VEDETI

GOOD TO KNOW



Vse vtičnice imajo vgrajeno varovalo pred dotikom elementov pod napetostjo.

All the sockets are equipped with a safety shutters assuring the protection to live contacts.



Dobro premišljena konstrukcija stikala omogoča enostavno indikacijo tudi naknadno.

The well-thought-out design of the switch enables the easy integration of the indication, including at a later time.



Za zanesljivost preklopa skrbijo kontakti iz srebrove zlitine.

Contacts made of silver alloy guarantee safe switching.



Brezvijačni kontakti omogočajo hitro in zanesljivo priključitev vodnikov. Na isti kontakt lahko pritrdite dva vodnika različnih premerov.

Plug-in contacts enable quick and reliable attachment of wires. Two wires of different diameters can be attached to the same contact.



Krepeljci omogočajo globljo pritrditev (tudi preko keramičnih ploščic ipd.).

Fixing claws enable deeper fixing (also through ceramic tiles, etc.)



Sestavljive doze vam bodo olajšale delo. Prave razdalje so vam zagotovljene.

Easy-fitting installation boxes will make your work easier. Proper lengths are guaranteed.

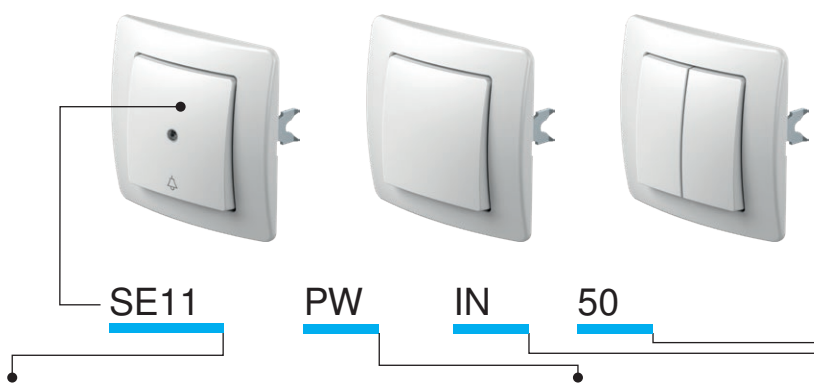

| tip type | naziv description | tehnični opis technical data | barva colour | opcijski opis 1 optional data 1 | opcijski opis 2 optional data 2 |
|-------------|--------------------------------------|---------------------------------|---|------------------------------------|------------------------------------|
| SE10 | STIKALO ENOPOLNO SWITCH 1WAY | 10AX 250V~ | <input type="checkbox"/> PW bela-sijaj polar white | NT nevtral neutral | 50 |
| SE11 | TIPKALO ENOPOLNO PUSH BUTTON 1WAY | 10A 250V~ | <input type="checkbox"/> IW bež-sijaj ivory white | IN indikator indicator | 51 |
| SE22 | STIKALO DVOPOLNO SWITCH 2POLE | 16AX 250V~ | <input type="checkbox"/> ES srebrna-mat elox silver | | 03 |
| ... | ... | ... | <input type="checkbox"/> CO beli duroplast white thermoset | | 04 |
| ... | ... | ... | <input type="checkbox"/> NB črna-sijaj night black | | ... |

STIKALO ENOPOLNO 10AX 250V~

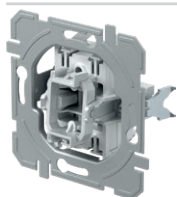

SE10

- 10AX 250V~, tip SE10
- ustreza EN 60669-1
- brezvijačna pritrditev vodnikov 1.5-2.5mm²



- SWITCH 1WAY 10AX 250V~
- 10AX 250V~, type SE10
 - in accordance with EN 60669-1
 - plug-in contacts 1.5-2.5mm²

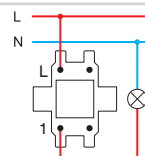

TIPKALO ENOPOLNO 10A 250V~

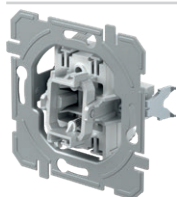

SE11

- 10A 250V~, tip SE11
- ustreza EN 60669-1
- brezvijačna pritrditev vodnikov 1.5-2.5mm²



- PUSH BUTTON 1WAY 10A 250V~
- 10A 250V~, type SE11
 - in accordance with EN 60669-1
 - plug-in contacts 1.5-2.5mm²

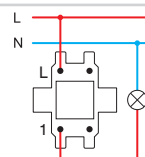

STIKALO DVOPOLNO 16AX 250V~

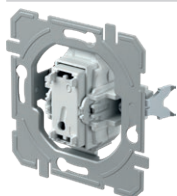

SE22

- 16AX 250V~, tip SE22
- ustreza EN 60669-1
- vijajna pritrditev vodnikov 1.5-2.5mm²
- samo v kombinaciji s tipko TE10_NT03

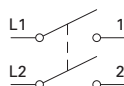

- SWITCH 2POLE 16AX 250V~
- 16AX 250V~, type SE22
 - in accordance with EN 60669-1
 - screw contacts 1.5-2.5mm²
 - only in combination with button TE10_NT03

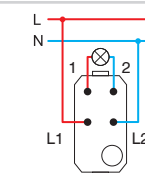

STIKALO SERIJSKO 10AX 250V~

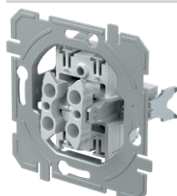

SE50

- 10AX 250V~, tip SE50
- ustreza EN 60669-1
- brezvijačna pritrditev vodnikov 1.5-2.5mm²

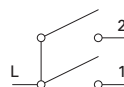

- SWITCH 2GANG-1WAY 10AX 250V~
- 10AX 250V~, type SE50
 - in accordance with EN 60669-1
 - plug-in contacts 1.5-2.5mm²

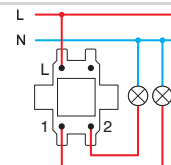

S W I T C H E S S E

TIPKALO SERIJSKO 10A 250V~

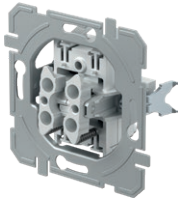

SE51

- 10A 250V~, tip SE51
- ustreza EN 60669-1
- brezvijačna pritrditev vodnikov 1.5-2.5mm²

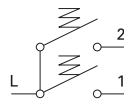

PUSH BUTTON 2GANG-1WAY 10A 250V~

- 10A 250V~, type SE51
- in accordance with EN 60669-1
- plug-in contacts 1.5-2.5mm²

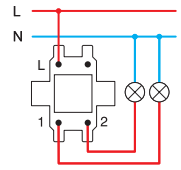

STIKALO ŽALUZIJSKO 10AX 250V~

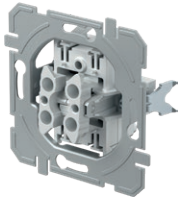

SE52

- 10AX 250V~, tip SE52
- ustreza EN 60669-1
- brezvijačna pritrditev vodnikov 1.5-2.5mm²
- z mehansko blokado hkratnega vklopa

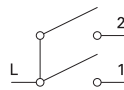

SWITCH SHUTTERS 10AX 250V~

- 10AX 250V~, type SE52
- in accordance with EN 60669-1
- plug-in contacts 1.5-2.5mm²
- with mechanical interblock

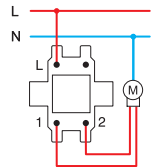

TIPKALO ŽALUZIJSKO 10A 250V~

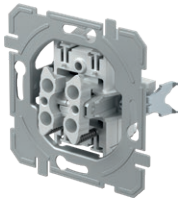

SE53

- 10A 250V~, tip SE53
- ustreza EN 60669-1
- brezvijačna pritrditev vodnikov 1.5-2.5mm²
- z mehansko blokado hkratnega vklopa

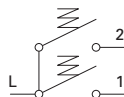

PUSH BUTTON SHUTTERS 10A 250V~

- 10A 250V~, type SE53
- in accordance with EN 60669-1
- plug-in contacts 1.5-2.5mm²
- with mechanical interblock

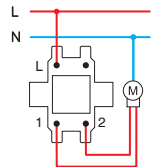

STIKALO MENJALNO 10AX 250V~

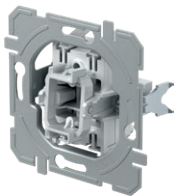

SE60

- 10AX 250V~, tip SE60
- ustreza EN 60669-1
- brezvijačna pritrditev vodnikov 1.5-2.5mm²

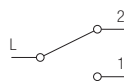

SWITCH 2WAY 10AX 250V~

- 10AX 250V~, type SE60
- in accordance with EN 60669-1
- plug-in contacts 1.5-2.5mm²

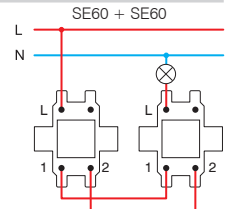

STIKALO DVOJNO MENJALNO 10AX 250V~

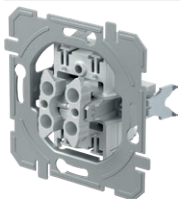

SE63

- 10AX 250V~, tip SE63
- ustreza EN 60669-1
- brezvijačna pritrditev vodnikov 1.5-2.5mm²



SWITCH DOUBLE 2WAY 10AX 250V~

- 10AX 250V~, type SE63
- in accordance with EN 60669-1
- plug-in contacts 1.5-2.5mm²

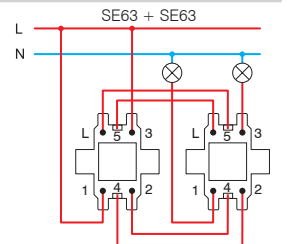

STIKALO KRIŽNO 10AX 250V~

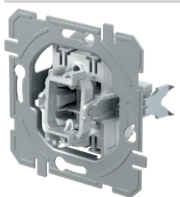

SE70

- 10AX 250V~, tip SE70
- ustreza EN 60669-1
- brezvijačna pritrditev vodnikov 1.5-2.5mm²



SWITCH INTERMEDIATE 10AX 250V~

- 10AX 250V~, type SE70
- in accordance with EN 60669-1
- plug-in contacts 1.5-2.5mm²

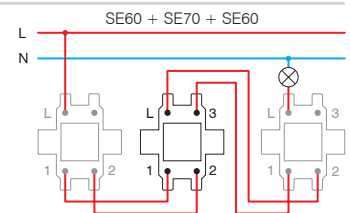

STIKALO ENOPOLNO 10AX 250V~



- SE10PW
- SE10IW
- SE10ES
- SE10CO
- SE10NB

- 10AX 250V~, tip SE10
 - ustreza EN 60669-1
 - brezvijačna pritrditev vodnikov 1.5-2.5mm²

SWITCH 1WAY 10AX 250V~
 - 10AX 250V~, type SE10
 - in accordance with EN 60669-1
 - plug-in contacts 1.5-2.5mm²



STIKALO ENOPOLNO 10AX 250V~ __ IN



- SE10PWIN
- SE10IWIN
- SE10ESIN
- SE10COIN
- SE10NBIN

- IN indikator
 - 10AX 250V~, tip SE10
 - ustreza EN 60669-1
 - brezvijačna pritrditev vodnikov 1.5-2.5mm²

SWITCH 1WAY 10AX 250V~ __ IN
 - IN indicator
 - 10AX 250V~, type SE10
 - in accordance with EN 60669-1
 - plug-in contacts 1.5-2.5mm²



TIPKALO ENOPOLNO 10A 250V~



- SE11PW
- SE11IW
- SE11ES
- SE11CO
- SE11NB

- 10A 250V~, tip SE11
 - ustreza EN 60669-1
 - brezvijačna pritrditev vodnikov 1.5-2.5mm²

PUSH BUTTON 1WAY 10A 250V~
 - 10A 250V~, type SE11
 - in accordance with EN 60669-1
 - plug-in contacts 1.5-2.5mm²



TIPKALO ENOPOLNO 10A 250V~ __ TI 50



- SE11PWTI50
- SE11IWTI50
- SE11ESTI50
- SE11COTI50
- SE11NBTI50

- TI 50 indikator zvonec+tlivka
 - 10A 250V~, tip SE11
 - ustreza EN 60669-1
 - brezvijačna pritrditev vodnikov 1.5-2.5mm²

PUSH BUTTON 1WAY 10A 250V~ __ TI 50
 - TI 50 indicator bell+neon lamp
 - 10A 250V~, type SE11
 - in accordance with EN 60669-1
 - plug-in contacts 1.5-2.5mm²



TIPKALO ENOPOLNO 10A 250V~ __ TI 51



- SE11PWTI51
- SE11IWTI51
- SE11ESTI51
- SE11COTI51
- SE11NBTI51

- TI 51 indikator luč+tlivka
 - 10A 250V~, tip SE11
 - ustreza EN 60669-1
 - brezvijačna pritrditev vodnikov 1.5-2.5mm²

PUSH BUTTON 1WAY 10A 250V~ __ TI 51
 - TI 51 indicator light+neon lamp
 - 10A 250V~, type SE11
 - in accordance with EN 60669-1
 - plug-in contacts 1.5-2.5mm²



TIPKALO ENOPOLNO 10A 250V~ __ IL



- SE11PWIL
- SE11IWIL
- SE11ESIL
- SE11COIL
- SE11NBIL

- IL napisna ploščica
 - 10A 250V~, tip SE11
 - ustreza EN 60669-1
 - brezvijačna pritrditev vodnikov 1.5-2.5mm²

PUSH BUTTON 1WAY 10A 250V~ __ IL
 - IL inscription plate
 - 10A 250V~, type SE11
 - in accordance with EN 60669-1
 - plug-in contacts 1.5-2.5mm²



STIKALO DVOPOLNO 16AX 250V~ __ IN 03



- SE22PWIN03
- SE22IWIN03
- SE22ESIN03
- SE22NBIN03

- IN 03 nevtral 0-1
 - 16AX 250V~, tip SE22
 - ustreza EN 60669-1
 - vijajna pritrditev vodnikov 1.5-2.5mm²

SWITCH 2POLE 16AX 250V~ __ IN 03
 - IN 03 neutral 0-1
 - 16AX 250V~, type SE22
 - in accordance with EN 60669-1
 - screw contacts 1.5-2.5mm²



| | | | |
|--|---|---|--|
| | <ul style="list-style-type: none"> <input type="checkbox"/> SE50PW <input type="checkbox"/> SE50IW <input type="checkbox"/> SE50ES <input type="checkbox"/> SE50CO <input type="checkbox"/> SE50NB | <p>STIKALO SERIJSKO 10AX 250V~</p> <ul style="list-style-type: none"> - 10AX 250V~, tip SE50 - ustreza EN 60669-1 - brezvijačna pritrditev vodnikov 1.5-2.5mm² <p><i>SWITCH 2GANG-1WAY 10AX 250V~</i></p> <ul style="list-style-type: none"> - 10AX 250V~, type SE50 - in accordance with EN 60669-1 - plug-in contacts 1.5-2.5mm² | |
| | <ul style="list-style-type: none"> <input type="checkbox"/> SE51PW <input type="checkbox"/> SE51IW <input type="checkbox"/> SE51ES <input type="checkbox"/> SE51CO <input type="checkbox"/> SE51NB | <p>TIPKALO SERIJSKO 10A 250V~</p> <ul style="list-style-type: none"> - 10A 250V~, tip SE51 - ustreza EN 60669-1 - brezvijačna pritrditev vodnikov 1.5-2.5mm² <p><i>PUSH BUTTON 2GANG-1WAY 10A 250V~</i></p> <ul style="list-style-type: none"> - 10A 250V~, type SE51 - in accordance with EN 60669-1 - plug-in contacts 1.5-2.5mm² | |
| | <ul style="list-style-type: none"> <input type="checkbox"/> SE52PWNT09 <input type="checkbox"/> SE52IWNT09 <input type="checkbox"/> SE52ESNT09 <input type="checkbox"/> SE52CONT09 <input type="checkbox"/> SE52NBNT09 | <p>STIKALO ŽALUZIJSKO 10AX 250V~ __ NT 09</p> <ul style="list-style-type: none"> - NT 09 nevtral gor-dol - 10AX 250V~, tip SE52 - ustreza EN 60669-1 - brezvijačna pritrditev vodnikov 1.5-2.5mm² - z mehansko blokado hkratnega vklopa <p><i>SWITCH SHUTTERS 10AX 250V~ __ NT 09</i></p> <ul style="list-style-type: none"> - NT 09 neutral up-down - 10AX 250V~, type SE52 - in accordance with EN 60669-1 - plug-in contacts 1.5-2.5mm² - with mechanical interblock | |
| | <ul style="list-style-type: none"> <input type="checkbox"/> SE53PWNT09 <input type="checkbox"/> SE53IWNT09 <input type="checkbox"/> SE53ESNT09 <input type="checkbox"/> SE53CONT09 <input type="checkbox"/> SE53NBNT09 | <p>TIPKALO ŽALUZIJSKO 10A 250V~ __ NT 09</p> <ul style="list-style-type: none"> - NT 09 nevtral gor-dol - 10A 250V~, tip SE53 - ustreza EN 60669-1 - brezvijačna pritrditev vodnikov 1.5-2.5mm² - z mehansko blokado hkratnega vklopa <p><i>PUSH BUTTON SHUTTERS 10A 250V~ __ NT 09</i></p> <ul style="list-style-type: none"> - NT 09 neutral up-down - 10A 250V~, type SE53 - in accordance with EN 60669-1 - plug-in contacts 1.5-2.5mm² - with mechanical interblock | |
| | <ul style="list-style-type: none"> <input type="checkbox"/> SE60PW <input type="checkbox"/> SE60IW <input type="checkbox"/> SE60ES <input type="checkbox"/> SE60CO <input type="checkbox"/> SE60NB | <p>STIKALO MENJALNO 10AX 250V~</p> <ul style="list-style-type: none"> - 10AX 250V~, tip SE60 - ustreza EN 60669-1 - brezvijačna pritrditev vodnikov 1.5-2.5mm² <p><i>SWITCH 2WAY 10AX 250V~</i></p> <ul style="list-style-type: none"> - 10AX 250V~, type SE60 - in accordance with EN 60669-1 - plug-in contacts 1.5-2.5mm² | |
| | <ul style="list-style-type: none"> <input type="checkbox"/> SE63PW <input type="checkbox"/> SE63IW <input type="checkbox"/> SE63ES <input type="checkbox"/> SE63CO <input type="checkbox"/> SE63NB | <p>STIKALO DVOJNO MENJALNO 10AX 250V~</p> <ul style="list-style-type: none"> - 10AX 250V~, tip SE63 - ustreza EN 60669-1 - brezvijačna pritrditev vodnikov 1.5-2.5mm² <p><i>SWITCH DOUBLE 2WAY 10AX 250V~</i></p> <ul style="list-style-type: none"> - 10AX 250V~, type SE63 - in accordance with EN 60669-1 - plug-in contacts 1.5-2.5mm² | |
| | <ul style="list-style-type: none"> <input type="checkbox"/> SE70PW <input type="checkbox"/> SE70IW <input type="checkbox"/> SE70ES <input type="checkbox"/> SE70CO <input type="checkbox"/> SE70NB | <p>STIKALO KRIŽNO 10AX 250V~</p> <ul style="list-style-type: none"> - 10AX 250V~, tip SE70 - ustreza EN 60669-1 - brezvijačna pritrditev vodnikov 1.5-2.5mm² <p><i>SWITCH INTERMEDIATE 10AX 250V~</i></p> <ul style="list-style-type: none"> - 10AX 250V~, type SE70 - in accordance with EN 60669-1 - plug-in contacts 1.5-2.5mm² | |

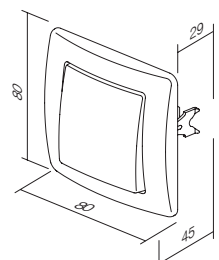
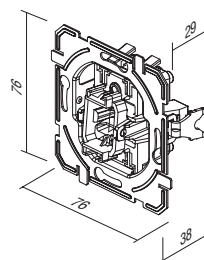

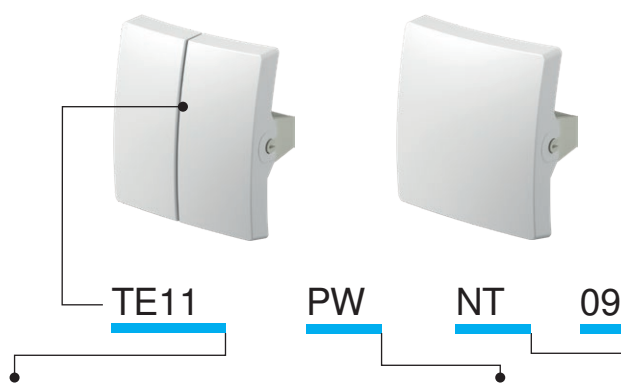

| tip type | naziv description | barva colour | opcijski opis 1 optional data 1 | opcijski opis 2 optional data 2 |
|-------------|--------------------------------|---|------------------------------------|------------------------------------|
| TE10 | TIPKA NAVADNA BUTTON 1GANG | <input type="checkbox"/> PW bela-sijaj polar white | NT nevtral neutral | 50 |
| TE11 | TIPKA SERIJSKA BUTTON 2GANG | <input type="checkbox"/> IW bež-sijaj ivory white | IN indikator indicator | 51 |
| ... | ... | <input type="checkbox"/> ES srebrna-mat elox silver | | 03 |
| ... | ... | <input type="checkbox"/> CO beli duroplast white thermoset | | 04 |
| ... | ... | <input type="checkbox"/> NB črna-sijaj night black | | ... |

TIPKA NAVADNA
- tipka skupaj z nosilcem
BUTTON 1GANG
- button together with carrier

- TE10PW
- TE10IW
- TE10ES
- TE10CO
- TE10NB

TIPKA INDIKATOR
- tipka skupaj z nosilcem
BUTTON INDICATOR
- button together with carrier

- TE10PWIN
- TE10IWIN
- TE10ESIN
- TE10COIN
- TE10NBIN

TIPKA Z NAPISNO PLOŠČICO
- tipka skupaj z nosilcem, z napisno ploščico
BUTTON WITH INSCRIPTION PLATE
- button together with carrier, with inscription plate

- TE13PWIL
- TE13IWIL
- TE13ESIL
- TE13NBIL

TIPKA SERIJSKA
- tipka serijska skupaj z nosilcem
BUTTON 2GANG
- button 2gang together with carrier

- TE11PW
- TE11IW
- TE11ES
- TE11CO
- TE11NB

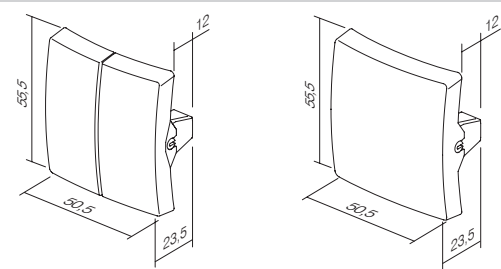

S I G N A L I Z A T I O N I A

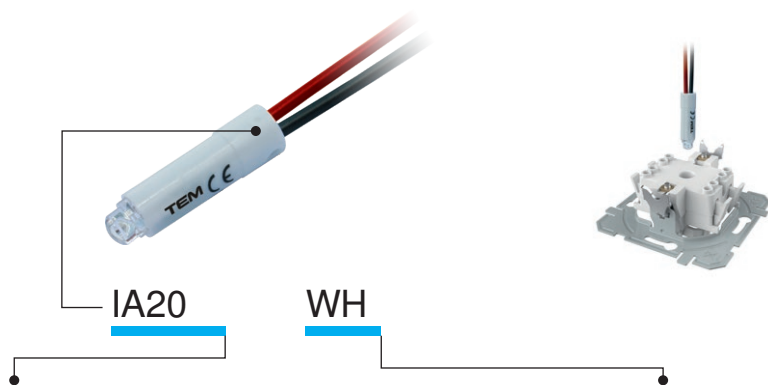

| tip type | naziv description | tehnični opis technical data | barva colour |
|-------------|--|---------------------------------|--|
| IA10 | TLIVKA NEON LAMP | 230V~ 0,34W | <input type="checkbox"/> WH bela white |
| IA20 | LED SIGNALIZACIJA LED SIGNALLING UNIT | 230V~ 0,40W | <input checked="" type="checkbox"/> BL modra blue |
| IA21 | LED SIGNALIZACIJA LED SIGNALLING UNIT | 24V AC/DC 0,20W | <input checked="" type="checkbox"/> RD rdeča red |
| ⋮ | ⋮ | ⋮ | <input checked="" type="checkbox"/> GR zelena green |
| ⋮ | ⋮ | ⋮ | <input checked="" type="checkbox"/> OR oranžna orange |

TLIVKA 230V~ 0,34W

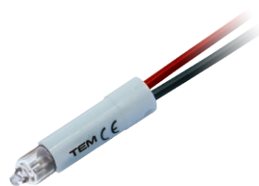
 IA10OR

- za indikacijo, signalizacijo ali stalno signalizacijo stikala
- v kombinaciji s tipko z indikatorjem

NEON LAMP 230V~ 0,34W

- for indication, signalling or permanent signalling
- in combination with a button featuring an indicator

LED SIGNALIZACIJA 230V AC/DC 0,40W

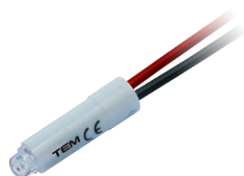

IA20WH
 IA20GR
 IA20RD
 IA20BL

- za indikacijo, signalizacijo ali stalno signalizacijo stikala
- v kombinaciji s tipko z indikatorjem

LED SIGNALLING UNIT 230V AC/DC 0,40W

- for indication, signalling or permanent signalling
- in combination with a button featuring an indicator

LED SIGNALIZACIJA 24V AC/DC 0,20W

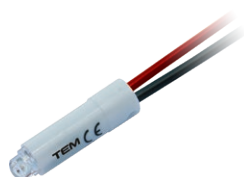

IA21WH
 IA21RD

- za indikacijo, signalizacijo ali stalno signalizacijo stikala
- v kombinaciji s tipko z indikatorjem

LED SIGNALLING UNIT 24V AC/DC 0,20W

- for indication, signalling or permanent signalling
- in combination with a button featuring an indicator

LED SIGNALIZACIJA 12V AC/DC 0,10W

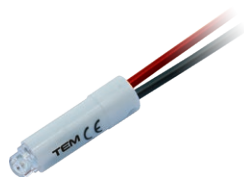

IA22WH
 IA22RD

- za indikacijo, signalizacijo ali stalno signalizacijo stikala
- v kombinaciji s tipko z indikatorjem

LED SIGNALLING UNIT 12V AC/DC 0,10W

- for indication, signalling or permanent signalling
- in combination with a button featuring an indicator

Indikacija /
Indication

* Signalizacija /
Signalization

Stalna signalizacija /
Permanent signalling

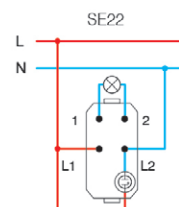
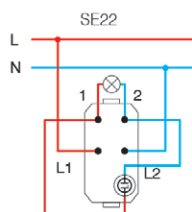
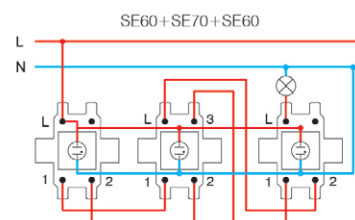
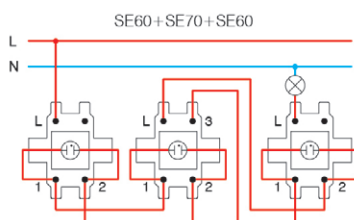
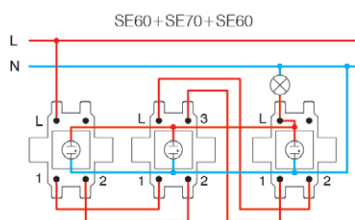
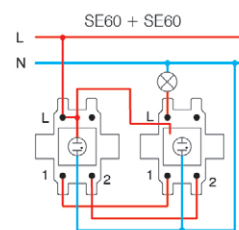
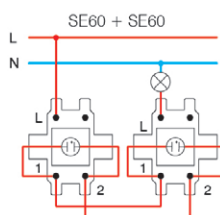
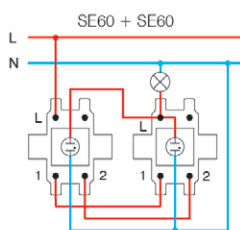
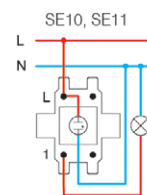
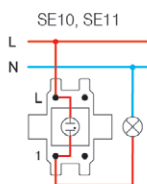
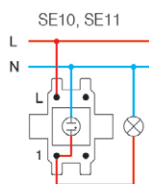

* vezave niso primerne za varčne (CFL, LED) sijalke /
the connections are not suitable for energy-saving bulbs (CFL, LED)

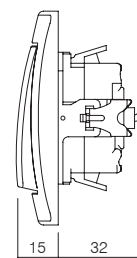

S O C K E T S V E



VE11



PT

XO

KS



| tip type | naziv description | tehnični opis technical data | opsijski opis 1 optional data 1 | opsijski opis 2 optional data 2 |
|-------------|---|---------------------------------|--|--|
| VE10 | VTIČNICA SCHUKO SOCKET SCHUKO | 2P+E 16A 250V~ | XO brez okvirja without cover plate | KS vgrajena zaščita pred dotikom kontaktov shuttered live contacts |
| VE11 | VTIČNICA SCHUKO+POKROV SOCKET SCHUKO+COVER | 2P+E 16A 250V~ | | |
| VE12 | VTIČNICA SCHUKO SOCKET SCHUKO | 2P+E 16A 250V~ BV | KS vgrajena zaščita pred dotikom kontaktov shuttered live contacts | |
| ⋮ | ⋮ | ⋮ | | |

barva
colour

| | | |
|--|---|---|
| <input type="checkbox"/> PW bela-sijaj polar white | <input checked="" type="checkbox"/> PT bela+prozorna white+transparent | <input type="checkbox"/> PP bela+bela white+white |
| <input checked="" type="checkbox"/> IW bež-sijaj ivory white | <input checked="" type="checkbox"/> IT bež+prozorna ivory+transparent | <input checked="" type="checkbox"/> II bež+bež ivory+ivory |
| <input type="checkbox"/> ES srebrna-mat elox silver | <input checked="" type="checkbox"/> ST srebrna+prozorna silver+transparent | <input type="checkbox"/> SS srebrna+srebrna silver+silver |
| <input type="checkbox"/> CO beli duroplast white thermoset | <input type="checkbox"/> CT bela+prozorna white+transparent | <input type="checkbox"/> BB črna+črna black+black |
| <input checked="" type="checkbox"/> NB črna-sijaj night black | <input checked="" type="checkbox"/> BT črna+prozorna black+transparent | <input checked="" type="checkbox"/> RR rdeča+rdeča red+red |
| <input checked="" type="checkbox"/> RD rdeča red | <input checked="" type="checkbox"/> RT rdeča+prozorna red+transparent | <input checked="" type="checkbox"/> GG zelena+zelena green+green |
| <input checked="" type="checkbox"/> GR zelena green | <input checked="" type="checkbox"/> GT zelena+prozorna green+transparent | <input checked="" type="checkbox"/> OO oranžna+oranžna orange+orange |
| <input checked="" type="checkbox"/> OR oranžna orange | <input checked="" type="checkbox"/> OT oranžna+prozorna orange+transparent | |



schuko - ustreza EN 60884-1, CEE7 (list III)

francoska - ustreza NF C 61-314 (list V)

schuko - in accordance with EN 60884-1, CEE7 (standard sheet III)

French - in accordance with NF C 61-314 (standard sheet V)

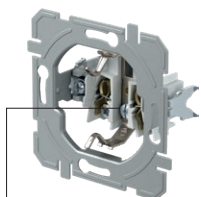
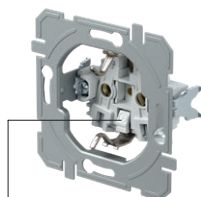
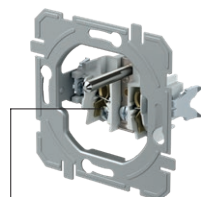
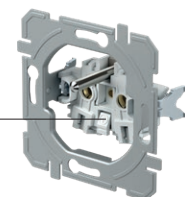
vijačna pritrnitev vodnikov
screw contactsBV brezvijačna pritrnitev vodnikov
BV plug-in contactsvijačna pritrnitev vodnikov
screw contactsBV brezvijačna pritrnitev vodnikov
BV plug-in contacts

VTIČNICA SCHUKO 2P+E 16A 250V~ __ XO

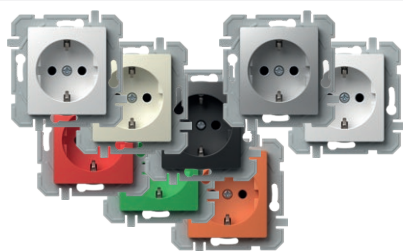

- VE10PWXO
- VE10IWXO
- VE10ESXO
- VE10COXO
- VE10NBXO
- VE10RDXO
- VE10GRXO
- VE10ORXO

- vijajna pritrditvev vodnikov 1.5-2.5mm²
- XO brez okvirja
- 2P+E schuko
- 16A 250V~, tip VE10

SOCKET SCHUKO 2P+E 16A 250V~ __ XO

- screw contacts 1.5-2.5mm²
- XO without surround
- 2P+E schuko
- 16A 250V~, type VE10



VTIČNICA SCHUKO+POKROV 2P+E 16A 250V~ __ XO



- VE11PTXO
- VE11ITXO
- VE11STXO
- VE11BTXO

- vijajna pritrditvev vodnikov 1.5-2.5mm²
- XO brez okvirja
- 2P+E schuko+pokrov
- 16A 250V~, tip VE11

SOCKET SCHUKO+COVER 2P+E 16A 250V~ __ XO

- screw contacts 1.5-2.5mm²
- XO without surround
- 2P+E schuko+cover
- 16A 250V~, type VE11



VTIČNICA SCHUKO 2P+E 16A 250V~ BV __ XO

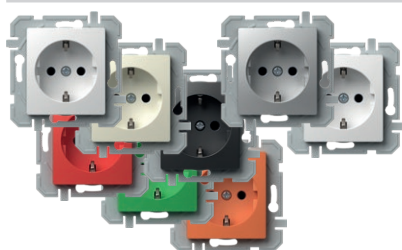

- VE12PWXO
- VE12IWXO
- VE12ESXO
- VE12COXO
- VE12NBXO
- VE12RDXO
- VE12GRXO
- VE12ORXO

- BV brezvijajna pritrditvev vodnikov 1.5-2.5mm²
- XO brez okvirja
- 2P+E schuko
- 16A 250V~, tip VE12

SOCKET SCHUKO 2P+E 16A 250V~ BV __ XO

- BV plug-in contacts 1.5-2.5mm²
- XO without surround
- 2P+E schuko
- 16A 250V~, type VE12



VTIČNICA SCHUKO+POKROV 2P+E 16A 250V~ BV __ XO



- VE13PTXO
- VE13ITXO
- VE13STXO
- VE13BTXO
- VE13PPXO

- BV brezvijajna pritrditvev vodnikov 1.5-2.5mm²
- XO brez okvirja
- 2P+E schuko+pokrov
- 16A 250V~, tip VE13

SOCKET SCHUKO+COVER 2P+E 16A 250V~ BV __ XO

- BV plug-in contacts 1.5-2.5mm²
- XO without surround
- 2P+E schuko+cover
- 16A 250V~, type VE13



VTIČNICA SCHUKO 2P+E 16A 250V~



- VE10PW
- VE10IW
- VE10ES
- VE10CO
- VE10NB

- vijajna pritrditvev vodnikov 1.5-2.5mm²
- 2P+E schuko
- 16A 250V~, tip VE10

SOCKET SCHUKO 2P+E 16A 250V~

- screw contacts 1.5-2.5mm²
- 2P+E schuko
- 16A 250V~, type VE10



VTIČNICA SCHUKO+POKROV 2P+E 16A 250V~



- VE11PT
- VE11IT
- VE11ST
- VE11CT
- VE11BT

- vijajna pritrditvev vodnikov 1.5-2.5mm²
- 2P+E schuko+pokrov
- 16A 250V~, tip VE11

SOCKET SCHUKO+COVER 2P+E 16A 250V~

- screw contacts 1.5-2.5mm²
- 2P+E schuko+cover
- 16A 250V~, type VE11



VTIČNICA SCHUKO 2P+E 16A 250V~ BV



- VE12PW
- VE12IW
- VE12ES
- VE12CO
- VE12NB

- BV brezvijajna pritrditvev vodnikov 1.5-2.5mm²
- 2P+E schuko
- 16A 250V~, tip VE12

SOCKET SCHUKO 2P+E 16A 250V~ BV

- BV plug-in contacts 1.5-2.5mm²
- 2P+E schuko
- 16A 250V~, type VE12



VTIČNICA SCHUKO+POKROV 2P+E 16A 250V~ BV



- VE13PT
- VE13IT
- VE13ST
- VE13CT
- VE13BT

- BV brezvijajna pritrditvev vodnikov 1.5-2.5mm²
- 2P+E schuko+pokrov
- 16A 250V~, tip VE13

SOCKET SCHUKO+COVER 2P+E 16A 250V~ BV

- BV plug-in contacts 1.5-2.5mm²
- 2P+E schuko+cover
- 16A 250V~, type VE13



S O C K E T S V E

VTIČNICA FRANCOSKA 2P+E 16A 250V~ __ XO

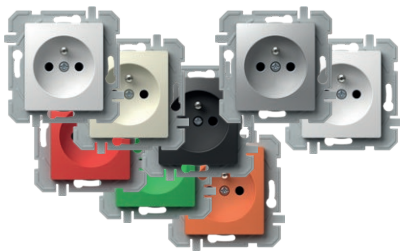

- VE40PWXO
- VE40IWXO
- VE40ESXO
- VE40COXO
- VE40NBXO
- VE40RDXO
- VE40GRXO
- VE40ORXO

- vijajna pritrnitev vodnikov 1.5-2.5mm²
- XO brez okvirja
- 2P+E francoska
- 16A 250V~, tip VE40

SOCKET FRENCH 2P+E 16A 250V~ __ XO

- screw contacts 1.5-2.5mm²
- XO without surround
- 2P+E French
- 16A 250V~, type VE40



VTIČNICA FRANCOSKA+POKROV 2P+E 16A 250V~ __ XO

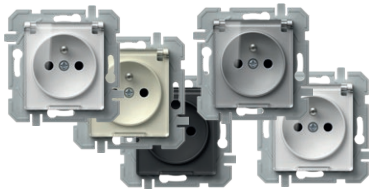

- VE41PTXO
- VE41ITXO
- VE41STXO
- VE41BTXO

- vijajna pritrnitev vodnikov 1.5-2.5mm²
- XO brez okvirja
- 2P+E francoska+pokrov
- 16A 250V~, tip VE41

SOCKET FRENCH+COVER 2P+E 16A 250V~ __ XO

- screw contacts 1.5-2.5mm²
- XO without surround
- 2P+E French+cover
- 16A 250V~, type VE41



VTIČNICA FRANCOSKA 2P+E 16A 250V~ BV __ XO



- VE42PWXO
- VE42IWXO
- VE42ESXO
- VE42COXO
- VE42NBXO
- VE42RDXO
- VE42GRXO
- VE42ORXO

- BV brezvijajna pritrnitev vodnikov 1.5-2.5mm²
- XO brez okvirja
- 2P+E francoska
- 16A 250V~, tip VE42

SOCKET FRENCH 2P+E 16A 250V~ BV __ XO

- BV plug-in contacts 1.5-2.5mm²
- XO without surround
- 2P+E French
- 16A 250V~, type VE42



VTIČNICA FRANCOSKA+POKROV 2P+E 16A 250V~ BV __ XO



- VE43PTXO
- VE43ITXO
- VE43STXO
- VE43BTXO

- BV brezvijajna pritrnitev vodnikov 1.5-2.5mm²
- XO brez okvirja
- 2P+E francoska+pokrov
- 16A 250V~, tip VE43

SOCKET FRENCH+COVER 2P+E 16A 250V~ BV __ XO

- BV plug-in contacts 1.5-2.5mm²
- XO without surround
- 2P+E French+cover
- 16A 250V~, type VE43



VTIČNICA FRANCOSKA 2P+E 16A 250V~



- VE40PW
- VE40IW
- VE40ES
- VE40CO
- VE40NB

- vijajna pritrnitev vodnikov 1.5-2.5mm²
- 2P+E francoska
- 16A 250V~, tip VE40

SOCKET FRENCH 2P+E 16A 250V~

- screw contacts 1.5-2.5mm²
- 2P+E French
- 16A 250V~, type VE40



VTIČNICA FRANCOSKA+POKROV 2P+E 16A 250V~



- VE41PT
- VE41IT
- VE41BT
- VE41ST

- vijajna pritrnitev vodnikov 1.5-2.5mm²
- 2P+E francoska+pokrov
- 16A 250V~, tip VE41

SOCKET FRENCH+COVER 2P+E 16A 250V~

- screw contacts 1.5-2.5mm²
- 2P+E French+cover
- 16A 250V~, type VE41



VTIČNICA FRANCOSKA 2P+E 16A 250V~ BV



- VE42PW
- VE42IW
- VE42ES
- VE42CO
- VE42NB

- BV brezvijajna pritrnitev vodnikov 1.5-2.5mm²
- 2P+E francoska
- 16A 250V~, tip VE42

SOCKET FRENCH 2P+E 16A 250V~ BV

- BV plug-in contacts 1.5-2.5mm²
- 2P+E French
- 16A 250V~, type VE42



VTIČNICA FRANCOSKA+KS+POKROV 2P+E 16A 250V~ BV



- VE43PT
- VE43IT
- VE43BT
- VE43ST

- BV brezvijajna pritrnitev vodnikov 1.5-2.5mm²
- 2P+E francoska+pokrov
- 16A 250V~, tip VE43

SOCKET FRENCH+COVER 2P+E 16A 250V~ BV

- BV plug-in contacts 1.5-2.5mm²
- 2P+E French+cover
- 16A 250V~, type VE43



VTIČNICA SCHUKO DVOJNA 2P+E 16A 250V~



- VE16PWKS
- VE16IWKS
- VE16ESKS
- VE16NBKS

- 2P+E schuko dvojna
 - 16A 250V~, tip VE16
 - ustreza IEC 60884-1, CEE7
 - vijačna pritrditev vodnikov 1.5-2.5 mm²
 - vgrajena zaščita pred dotikom kontaktov

SOCKET SCHUKO DOUBLE 2P+E 16A 250V~

- 2P+E schuko double
 - 16A 250V~, type VE16
 - in accordance with IEC 60884-1, CEE7
 - screw contacts 1.5-2.5 mm²
 - shuttered live contacts



VTIČNICA FRANCOSKA DVOJNA 2P+E 16A 250V~



- VE46PWKS
- VE46IWKS
- VE46ESKS
- VE46NBKS

- 2P+E francoska dvojna
 - 16A 250V~, tip VE46
 - ustreza IEC 60884-1, CEE7; NF C 61-314,
 ČSN 33 2318; PN-E 93201
 - vijačna pritrditev vodnikov 1,5-2,5 mm²
 - vgrajena zaščita pred dotikom kontaktov

SOCKET FRENCH DOUBLE 2P+E 16A 250V~

- 2P+E French double
 - 16A 250V~, type VE46
 - in accordance with IEC 60884-1, CEE7; NF C 61-314,
 ČSN 33 2318; PN-E 93201
 - screw contacts 1,5-2,5 mm²
 - shuttered live contacts



VTIČNICA 2P 16A 250V~



- VE30PW
- VE30IW
- VE30ES
- VE30NB

- 2P brez ozemljitvenega kontakta
 - 16A 250V~
 - ustreza EN 60884-1, CEE7 (list I)
 - vijačna pritrditev vodnikov 1.5-2.5mm²

SOCKET 2P 16A 250V~

- 2P without earthing contact
 - 16A 250V~
 - in accordance with EN 60884-1, CEE7 (standard sheet I)
 - screw contacts 1.5-2.5mm²

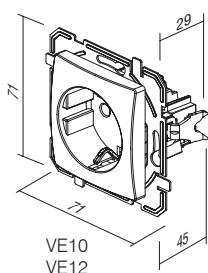

VE10
VE12

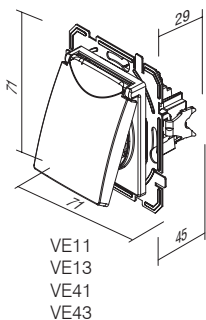

VE11
VE13
VE41
VE43

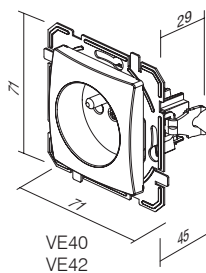

VE40
VE42

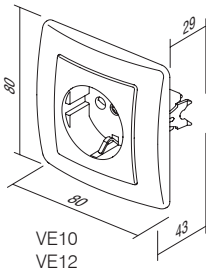

VE10
VE12

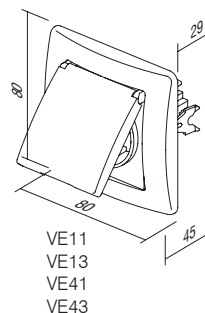

VE11
VE13
VE41
VE43

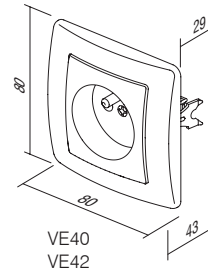

VE40
VE42

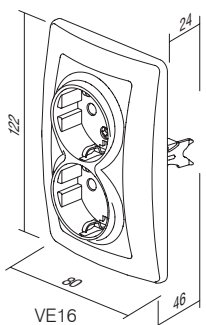

VE16

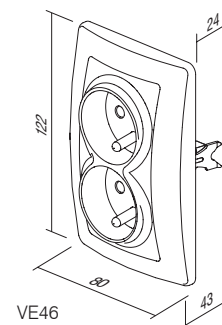

VE46



KE37

PW

| tip type | naziv description | tehnični opis technical data | barva colour |
|-------------|--|---------------------------------|---|
| KE11 | VTIČNICA TV-R KONČNA SOCKET TV-R END-LINE | 1dB | <input type="checkbox"/> PW bela-sijaj polar white |
| KE12 | VTIČNICA TV-R PREHODNA SOCKET TV-R THROUGHPASS | 10dB | <input type="checkbox"/> IW bež-sijaj ivory white |
| KE16 | VTIČNICA SAT-TV-R KONČNA SOCKET SAT-TV-R END-LINE | 3dB | <input type="checkbox"/> ES srebrna-mat elox silver |
| ⋮ | ⋮ | ⋮ | <input type="checkbox"/> CO beli duroplast white thermoset |
| ⋮ | ⋮ | ⋮ | <input type="checkbox"/> NB črna-sijaj night black |

VTIČNICA TV-R KONČNA 1dB



KE11

- TV-R končna
- frekvenčni pas 5÷862MHz
- dušenje: R-1,5dB, TV-1dB
- ustreza EN 50083-1
- vijajna priključitev

SOCKET TV-R END-LINE 1dB

- TV-R end-line
- frequency range 5÷862MHz
- reduction: R-1,5dB, TV-1dB
- in accordance with EN 50083-1
- screw contacts

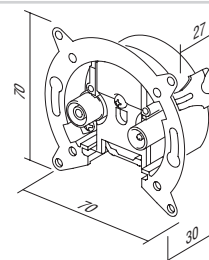
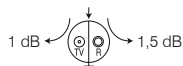

VTIČNICA TV-R PREHODNA 10dB



KE12

- TV-R prehodna vtičnica
- frekvenčni pas 5÷862MHz
- dušenje: R-10dB, TV-10dB, prehod-2dB
- ustreza EN 50083-1
- vijajna priključitev

SOCKET TV-R TROUGHPASS 10dB

- TV-R troughpass
- frequency range 5÷862MHz
- reduction: R-10dB, TV-10dB, trough-2dB
- in accordance with EN 50083-1
- screw contacts

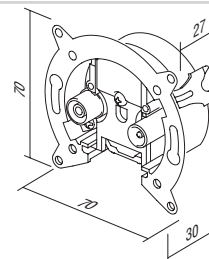
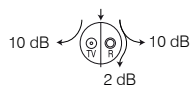

VTIČNICA SAT-TV-R KONČNA 3dB



KE16

- SAT-TV-R končna
- frekvenčni pas 5÷2400MHz
- dušenje: R-1dB, TV-1,5dB, SAT-3dB
- vgradnja v dozo Ø60 s krepeljci ali vijaki
- ustreza EN 50083-1
- vijajna pritrditev vodnikov

SOCKET SAT-TV-R END-LINE 3dB

- SAT-TV-R end-line
- frequency range 5÷2400MHz
- reduction: R-1dB, TV-1,5dB, SAT-3dB
- for mounting in round box Ø60 with claws or screws
- in accordance with EN 50083-1
- screw contacts

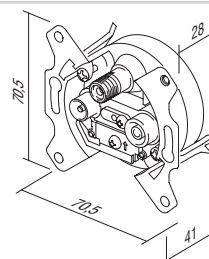
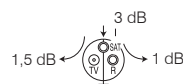

VTIČNICA TEL KS RJ11 6/4

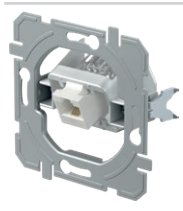

KE36

- KS keystone pritrditveni standard
- RJ11 6/4
- ustreza IEC 60603-7

SOCKET TEL KS RJ11 6/4

- KS keystone fixing standard
- RJ11 6/4
- in accordance with IEC 60603-7

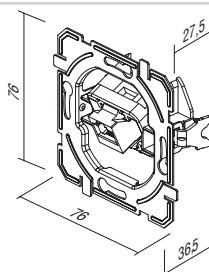

VTIČNICA CAT5e KS RJ45 8/8

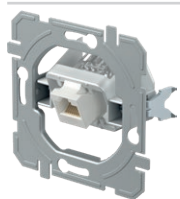

KE37

- KS keystone pritrditveni standard
- CAT5e, RJ45 8/8
- ustreza IEC 60603-7

SOCKET CAT5e KS RJ45 8/8
 - KS keystone fixing standard
 - CAT5e, RJ45 8/8
 - in accordance with IEC 60603-7

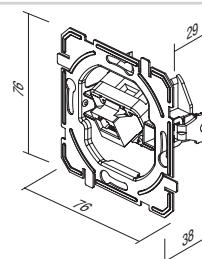

VTIČNICA CAT6s KS RJ45 8/8 SLIM

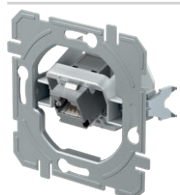

KE40

- KS keystone pritrditveni standard
- CAT6s, RJ45 8/8
- ustreza IEC 60603-7

SOCKET CAT6s KS RJ45 8/8 SLIM
 - KS keystone fixing standard
 - CAT6s, RJ45 8/8
 - in accordance with IEC 60603-7

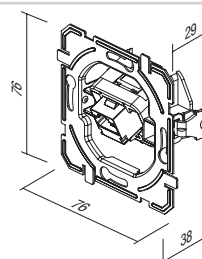

VTIČNICA TEL KS DVOJNA 2x RJ11 6/4

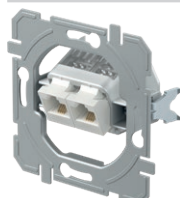

KE38

- KS keystone pritrditveni standard
- 2x RJ11 6/4
- ustreza IEC 60603-7

SOCKET TEL KS DOUBLE 2x RJ11 6/4
 - KS keystone fixing standard
 - 2x RJ11 6/4
 - in accordance with IEC 60603-7

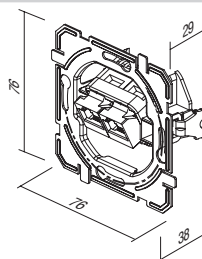

VTIČNICA CAT5e KS DVOJNA 2x RJ45 8/8



KE39

- KS keystone pritrditveni standard
- 2x CAT5e, RJ45 8/8
- ustreza IEC 60603-7

SOCKET CAT5e KS DOUBLE 2x RJ45 8/8
 - KS keystone fixing standard
 - 2x CAT5e, RJ45 8/8
 - in accordance with IEC 60603-7

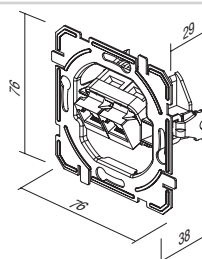

VTIČNICA CAT6s KS DVOJNA 2x RJ45 8/8 SLIM

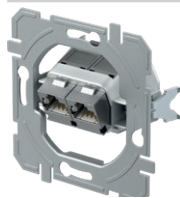

KE41

- KS keystone pritrditveni standard
- 2x CAT6s, RJ45 8/8
- ustreza IEC 60603-7

SOCKET CAT6s KS DOUBLE 2x RJ45 8/8 SLIM
 - KS keystone fixing standard
 - 2x CAT6s, RJ45 8/8
 - in accordance with IEC 60603-7

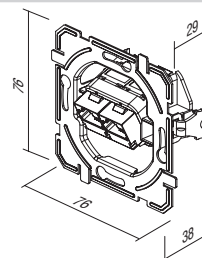

ADAPTER KS ENOJNI

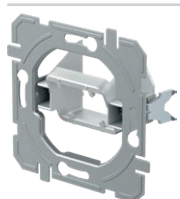

KE45

- KS keystone pritrditveni standard - enojni
- AMP, Avaya, Brandrex, FMT, Mfico, Tyco, ...
- komunikacijski modul ni vgrajen

ADAPTER KS SINGLE
 - KS keystone fixing standard - single
 - AMP, Avaya, Brandrex, FMT, Mfico, Tyco, ...
 - communication module not included

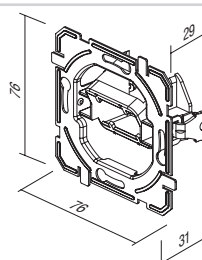

ADAPTER KS DVOJNI

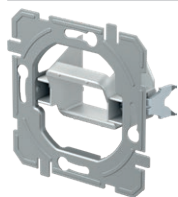

KE46

- KS keystone pritrditveni standard - dvojni
- AMP, Tyco, ...
- komunikacijski modul ni vgrajen

ADAPTER KS DOUBLE

- KS keystone fixing standard - double
- AMP, Tyco, ...
- communication module not included

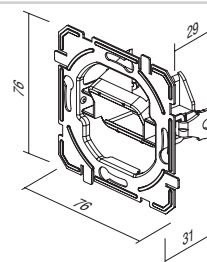

ADAPTER PD DVOJNI

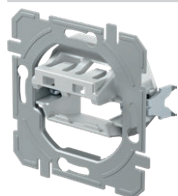

KE47

- PD Panduit MiniCOM pritrditveni standard - dvojni
- komunikacijski modul ni vgrajen

ADAPTER PD DOUBLE

- PD Panduit Mini-COM fixing standard - double
- communication module not included

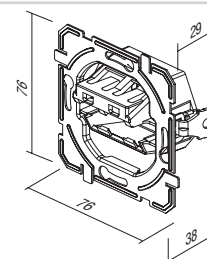

VTIČNICA TV OSNOVNA 0dB



- KE10PW
- KE10IW
- KE10ES
- KE10CO
- KE10NB

- TV osnovna
- dušenje 0dB
- konektor zadaj – F standard

SOCKET TV BASIC 0dB

- TV basic
- reduction 0dB
- back connector – F standard



VTIČNICA TV-R KONČNA 1dB



- KE11PW
- KE11IW
- KE11ES
- KE11CO
- KE11NB

- TV-R končna
- frekvenčni pas 5÷862 MHz
- dušenje: R-1.5dB, TV-1dB
- ustreza EN 50083-1
- vijačna priključitev

SOCKET TV-R END-LINE 1dB

- TV-R end-line
- frequency range 5÷862 MHz
- reduction: R-1.5dB, TV-1dB
- in accordance with EN 50083-1
- screw contact



VTIČNICA TV-R PREHODNA 10dB



- KE12PW
- KE12IW
- KE12ES
- KE12CO
- KE12NB

- TV-R prehodna
- frekvenčni pas 5÷862 MHz
- dušenje: R-10dB, TV-10dB, prehod-2dB
- ustreza EN 50083-1
- vijačna priključitev

SOCKET TV-R TROUGH-PASS 10dB

- TV-R troughpass
- frequency range 5÷862 MHz
- reduction: R-10dB, TV-10dB, trough-2dB
- in accordance with EN 50083-1
- screw contacts



VTIČNICA SAT-TV-R KONČNA 3dB



- KE16PW
- KE16IW
- KE16ES
- KE16CO
- KE16NB

- SAT-TV-R končna
- frekvenčni pas 5÷2400 MHz
- dušenje: R-1dB, TV-1.5dB, SAT-3dB
- ustreza EN 50083-1
- vijačna priključitev

SOCKET SAT-TV-R END-LINE 3dB

- SAT-TV-R end-line
- frequency range 5÷2400 MHz
- reduction: R-1dB, TV-1.5dB, SAT-3dB
- in accordance with EN 50083-1
- screw contacts



VTIČNICA AVDIO 2xRCA



- KE22PW
- KE22IW
- KE22ES
- KE22CO
- KE22NB

- avdio 2xRCA
- pritrditve vodnikov s spajkanjem

SOCKET AUDIO 2xRCA

- audio 2xRCA
- soldering connection of cable



VTIČNICA AVDIO ZVOČNIŠKA



- KE23PW
- KE23IW
- KE23ES
- KE23CO
- KE23NB

- avdio 2x Ø4mm
- za priklop zvočniškega vodnika, vtiča Ø4mm ali viličastega kabel čevlja
- pritrditve vodnikov zadaj s spajkanjem

SOCKET AUDIO LOUDSPEAKERS

- audio 2x Ø4mm
- to accommodate speaker wire, banana plug Ø4mm or spades
- soldering connection of cable at the back side



VTIČNICA TEL KS RJ11 6/4

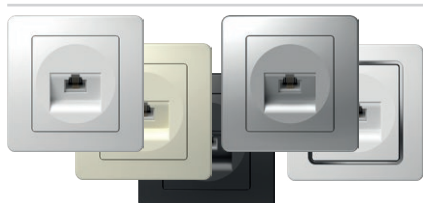

- KE36PW
- KE36IW
- KE36ES
- KE36CO
- KE36NB

- KS keystone pritrditveni standard
- RJ11 6/4
- ustreza IEC 60603-7

SOCKET TEL KS RJ11 6/4

- KS keystone fixing standard
- RJ11 6/4
- in accordance with IEC 60603-7



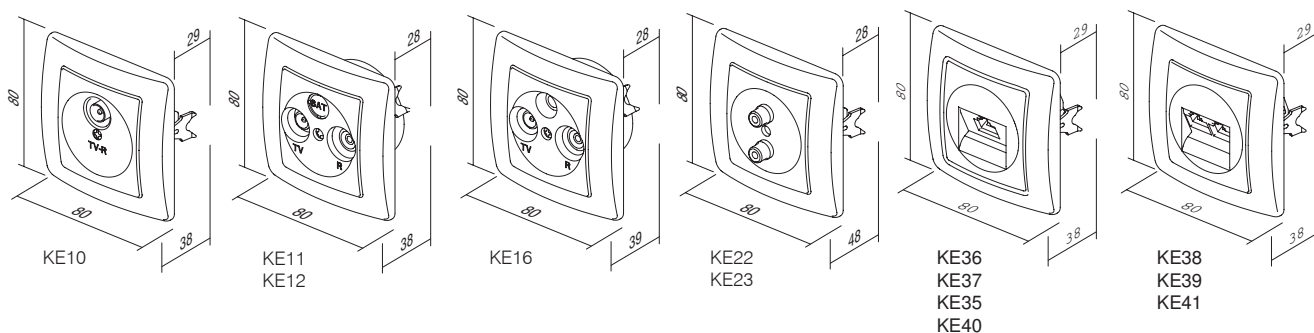
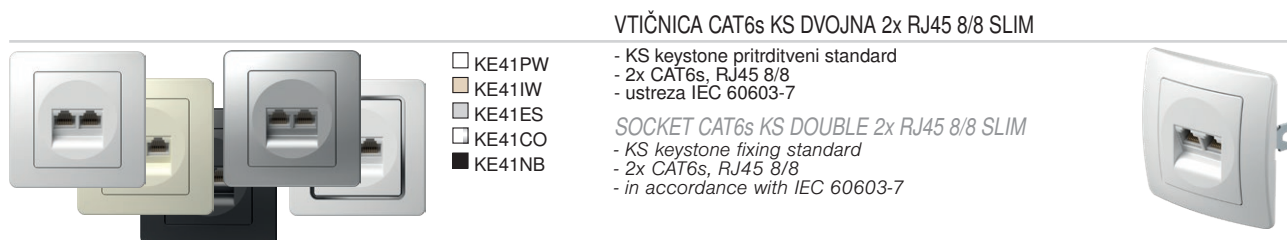
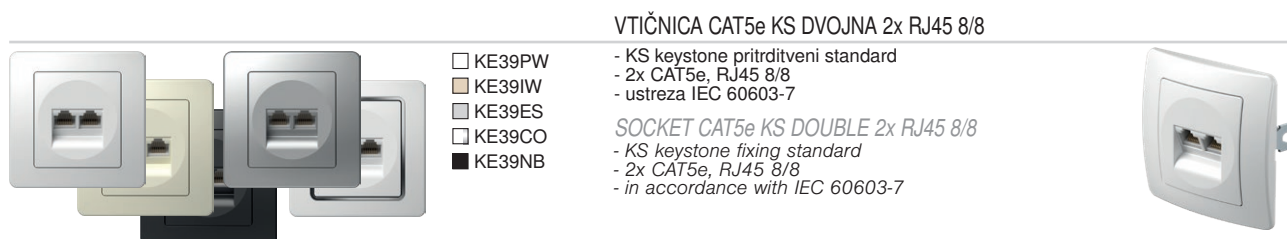
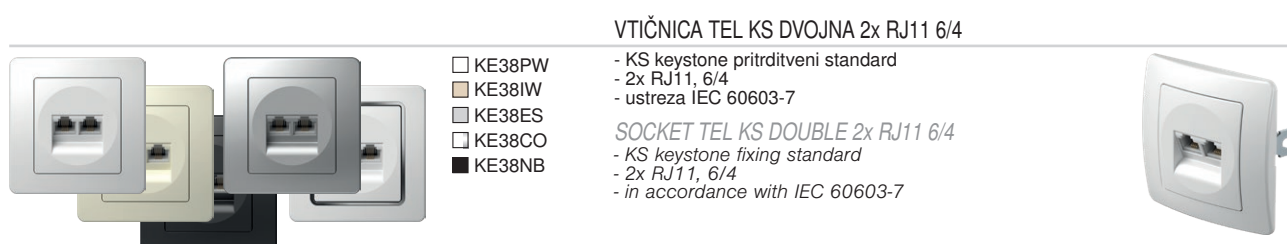
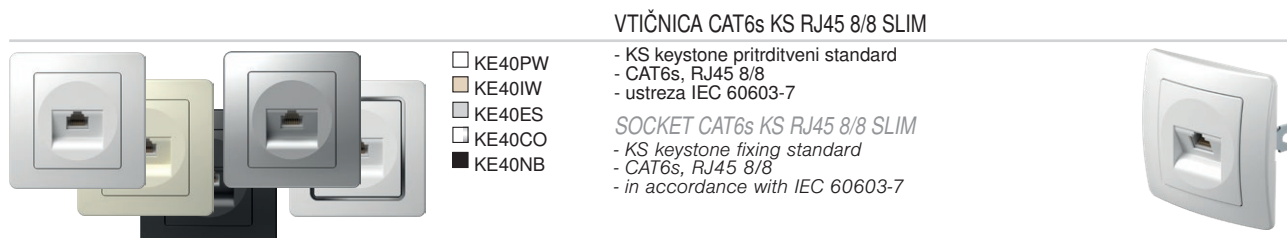
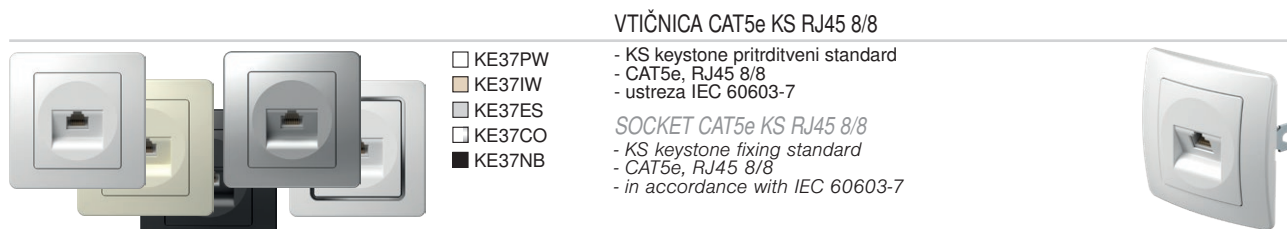

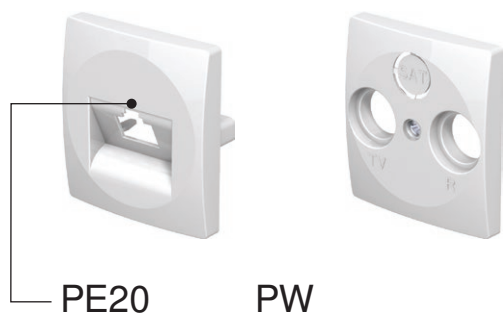

| tip type | naziv description | tehnični opis technical data | barva colour |
|-------------|-------------------------------------|---------------------------------|---|
| PE10 | POKROV TV-R COVER TV-R | 2P/3P | <input type="checkbox"/> PW bela-sijaj polar white |
| PE20 | POKROV KS ENOJNI COVER KS SINGLE | | <input type="checkbox"/> IW bež-sijaj ivory white |
| PE21 | POKROV KS DVOJNI COVER KS DOUBLE | | <input type="checkbox"/> ES srebrna-mat elox silver |
| ⋮ | ⋮ | ⋮ | <input type="checkbox"/> CO beli duroplast white thermoset |
| | | | <input type="checkbox"/> NB črna-sijaj night black |

POKROV TV-R 2P/3P



- PE10PW
- PE10IW
- PE10ES
- PE10CO
- PE10NB

- TV-R pokrov, 2P ali 3P z vijakom

COVER TV-R 2P/3P

- TV-R cover, 2P or 3P with screw



POKROV KS ENOJNI

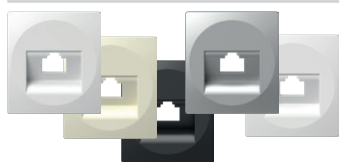

- PE20PW
- PE20IW
- PE20ES
- PE20CO
- PE20NB

- KS pokrov enojni

COVER KS SINGLE

- KS cover single



POKROV KS DVOJNI

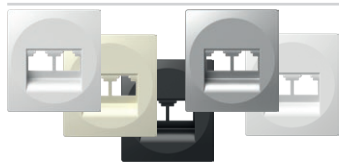

- PE21PW
- PE21IW
- PE21ES
- PE21NB

- KS pokrov dvojni

COVER KS DOUBLE

- KS cover double



POKROV TAE/TDO



- PE30PW
- PE30IW
- PE30ES
- PE30NB

- TAE ali TDO pokrov z vijakom

COVER TAE/TDO

- TAE or TDO cover with screw

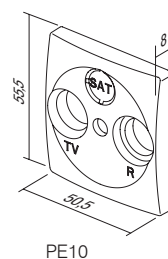
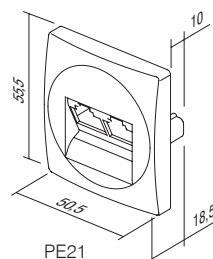
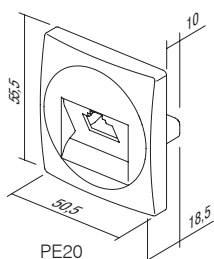
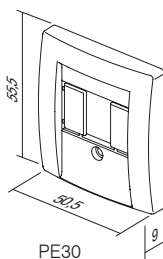



EE15

PW

| tip type | naziv description | tehnični opis technical data | barva colour |
|-------------|---|---------------------------------|--|
| EE15 | ZATEMNILNIK ROTACIJSKI MEN <i>DIMMER ROTATIVE 2WAY</i> | RL 400W | <input type="checkbox"/> PW bela-sijaj <i>polar white</i> |
| EE16 | ZATEMNILNIK ROTACIJSKI MEN <i>DIMMER ROTATIVE 2WAY</i> | RLC 400W | <input type="checkbox"/> IW bež-sijaj <i>ivory white</i> |
| EE19 | ZATEMNILNIK ROTACIJSKI MEN <i>DIMMER ROTATIVE 2WAY</i> | LED 100W | <input type="checkbox"/> ES srebrna-mat <i>elox silver</i> |
| ⋮ | ⋮ | ⋮ | <input type="checkbox"/> CO beli duroplast <i>white thermoset</i> |
| ⋮ | ⋮ | ⋮ | <input type="checkbox"/> NB črna-sijaj <i>night black</i> |

ZATEMNILNIK ROTACIJSKI MEN RL 400W



EE15

- rotacijski z menjalnim stikalom
- breme RL, 40W - 400W
- možna vezava z menjalnim stikalom
- vezava večih zatemnilnikov ni dovoljena
- ustreza EN 60669-1 in EN 60669-2-1
- brezvijačna pritrditev vodnikov 1.5mm²
- napajanje 230V~ 50Hz
- premer nastavka gumba Ø6mm
- zamenljiva varovalka vključena

DIMMER ROTATIVE 2WAY RL 400W

- rotation control with 2-way switch
- load RL, 40W - 400W
- 2-way switch combination is possible
- more dimmers combination is not allowed
- in accordance with EN 60669-1 and EN 60669-2-1
- plug-in contacts 1.5mm²
- supply 230V~ 50Hz
- button inner diameter Ø6mm
- replaceable fuse included

ZATEMNILNIK ROTACIJSKI MEN RLC 400W



EE16

- rotacijski z menjalnim stikalom
- breme RLC, 20W - 400W
- možna vezava z menjalnim stikalom
- vezava večih zatemnilnikov ni dovoljena
- ustreza EN 60669-1 in EN 60669-2-1
- brezvijačna pritrditev vodnikov 1.5mm²
- napajanje 230V~ 50Hz
- premer nastavka gumba Ø6mm
- elektronska varovalka

DIMMER ROTATIVE 2WAY RLC 400W

- rotation control with 2-way switch
- load RLC, 20W - 400W
- 2-way switch combination is possible
- more dimmers combination is not allowed
- in accordance with EN 60669-1 and EN 60669-2-1
- plug-in contacts 1.5mm²
- supply 230V~ 50Hz
- button inner diameter Ø6mm
- electronic fuse

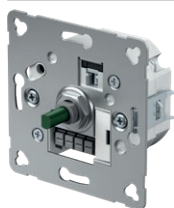

EE19

ZATEMNILNIK ROTACIJSKI MEN LED 100W

- rotacijski z menjalnim stikalom
- breme: LED, 0-100W (max. 10 LED sijalk)
GLS, 10-250W
- možna vezava z menjalnim stikalom
- vezava več zatemnilnikov ni dovoljena
- ustreza EN 60669-1 in EN 60669-2-1
- brezvijačna pritrditev vodnikov 1,5 mm²
- napajanje 230V~ 50 Hz
- zamenljiva varovalka vključena
- premer nastavka gumba Ø6mm

DIMMER ROTATIVE 2WAY LED 100W

- rotation control with 2-way switch
- load: LED, 0-100W (max. 10 LEDs)
GLS, 10-250W
- 2-way switch combination is possible
- more dimmers combination is not allowed
- in accordance with EN 60669-1 and EN 60669-2-1
- plug-in contacts 1.5mm²
- supply 230V~ 50Hz
- replaceable fuse included
- button inner diameter Ø6mm

IR STIKALO 5A 230V~

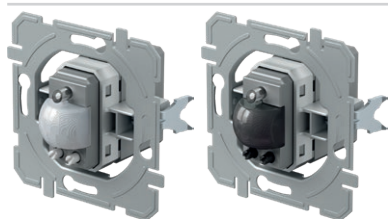

- EE32A1
- EE32A2

- IR infrardeče stikalo
- napajanje: 230V~ ±10 % 50Hz
- rele: 5A / 250V~ (zero crossing)
- stopnja varnosti: IP40
- presek žic pri stičniku: 0,75 - 2,5 mm²
- kot zaznavanja: do 110° pri 20°C
- območje zaznavanja: približno 8 m pri 20°C
- nastavljivost časovnega trajanja: od približno 5 s do 12 min
- nastavljivost osvetlitve: od približno 5 do 200 LUX
- temperatura delovanja: od 0°C do +40°C
- ni primeren za vgradnjo v doze, globine 45 mm
- samo za notranjo uporabo

IR SWITCH 5A 230V~

- IR infrared switch
- supply voltage: 230V~ ±10 % 50Hz
- relay: 5A / 250V~ (zero crossing)
- protection rating: IP40
- cross-section of wires at the contact terminal: 0.75 - 2.5 mm²
- detection angle: up to 110° at 20°C
- detection area: approx. 8 m at 20°C
- adjustability of duration: from approx. 5 s to 12 min
- adjustability of brightness: from approx. 5 to 200 LUX
- operating temperature: from 0°C to +40°C
- not suitable for installation in 45 mm deep boxes
- only for indoor usage

POLNILNIK USB 5V 2,4A

 EE67

- za polnjenje elektronskih naprav prek standardnega USB priključka (kompatibilno tudi z Apple napravami)
- napajanje:
100-230 V~ 50/60 Hz
- poraba med delovanjem:
300 mA pri 100 V~/150 mA pri 230 V~
- poraba v mirovanju:
30 mW pri 230 V~
- izhodna napetost:
5 VDC (±5 %) SELV
- nihanje izhodne napetosti: 150 mV
- nominalni izhodni tok: 2,4 A (±10 %)
- tip konektorja: USB A / USB A
- učinkovitost: maksimalno 77 %
- temperatura delovanja: 0 °C/+ 45 °C (notranja uporaba)
- IP zaščitni razred: IP20, samo za notranjo uporabo
- varnostni razred naprave II
- prenapetostna zaščita (EN 62109): razred III
- vijačna pritrditev vodnikov max. 2.5 mm²
- naprava z odmikom kontaktov min. 3 mm
- ustreza standardu EN 60950-1 in direktivam EMC in LVD

USB POWER SUPPLY UNIT 5V 2.4A

- for charging electronic devices via a standard USB port (also compatible with Apple devices)
- power supply: 100-230V~ 50/60Hz
- power consumption: 300mA at 100V~/150mA at 230V~
- standby power consumption: 30mW at 230V~
- nominal output voltage: 5 VCD (± 5%) SELV
- output ripple voltage: 150mV
- nominal output current: 2.4A (±10%)
- connector type: USB A / USB A
- efficiency: maximum of 77%
- operating temperature: 0°C/+45°C (indoor use)
- IP protection class: IP20, indoor use only
- class device II
- overvoltage category (EN 62109): Class III
- screw contacts: max. 2.5 mm²
- device with a contact gap of at least 3mm
- in accordance with the EN 60950-1 and LVD & EMC directives



- EE15PW
- EE15IW
- EE15ES
- EE15CO
- EE15NB

ZATEMNILNIK ROTACIJSKI MEN RL 400W

- rotacijski z menjalnim stikalom
- breme RL, 40W - 400W
- možna vezava z menjalnim stikalom
- vezava večih zatemnilnikov ni dovoljena
- ustreza EN 60669-1 in EN 60669-2-1
- brezvijačna pritrditev vodnikov 1.5mm²
- napajanje 230V~ 50Hz
- zamenljiva varovalka vključena



DIMMER ROTATIVE 2WAY RL 400W

- rotation control with 2-way switch
- load RL, 40W - 400W
- 2-way switch combination is possible
- more dimmers combination is not allowed
- in accordance with EN 60669-1 and EN 60669-2-1
- plug-in contacts 1.5mm²
- supply 230V~ 50Hz
- replaceable fuse included



- EE16PW
- EE16IW
- EE16ES
- EE16CO
- EE16NB

ZATEMNILNIK ROTACIJSKI MEN RLC 400W

- rotacijski z menjalnim stikalom
- breme RLC, 20W - 400W
- možna vezava z menjalnim stikalom
- vezava večih zatemnilnikov ni dovoljena
- ustreza EN 60669-1 in EN 60669-2-1
- brezvijačna pritrditev vodnikov 1.5mm²
- napajanje 230V~ 50Hz
- elektronska varovalka



DIMMER ROTATIVE 2WAY RLC 400W

- rotation control with 2-way switch
- load RLC, 20W - 400W
- 2-way switch combination is possible
- more dimmers combination is not allowed
- in accordance with EN 60669-1 and EN 60669-2-1
- plug-in contacts 1.5mm²
- supply 230V~ 50Hz
- electronic fuse



- EE19PW
- EE19IW
- EE19ES
- EE19CO
- EE19NB

ZATEMNILNIK ROTACIJSKI MEN LED 100W

- rotacijski z menjalnim stikalom
- breme: LED, 0-100W (max. 10 LED sijalk)
GLS, 10-250W
- možna vezava z menjalnim stikalom
- vezava več zatemnilnikov ni dovoljena
- ustreza EN 60669-1 in EN 60669-2-1
- brezvijačna pritrditev vodnikov 1,5 mm²
- napajanje 230V~ 50 Hz
- zamenljiva varovalka vključena



DIMMER ROTATIVE 2WAY LED 100W

- rotation control with 2-way switch
- load: LED, 0-100W (max. 10 LEDs)
GLS, 10-250W
- 2-way switch combination is possible
- more dimmers combination is not allowed
- in accordance with EN 60669-1 and EN 60669-2-1
- plug-in contacts 1.5mm²
- supply 230V~ 50Hz
- replaceable fuse included



- EE32PW
- EE32IW
- EE32ES
- EE32CO
- EE32NB

IR STIKALO 5A 230V~

- IR infrardeče stikalo
- napajanje: 230V~ ±10 % 50Hz
- rele: 5A / 250V~ (zero crossing)
- stopnja varnosti: IP40
- presek žic pri stičniku: 0,75 - 2,5 mm²
- kot zaznavanja: do 110° pri 20°C
- območje zaznavanja: približno 8 m pri 20°C
- nastaviteljnost časovnega trajanja: od približno 5 s do 12 min
- nastaviteljnost osvetlitve: od približno 5 do 200 LUX
- temperatura delovanja: od 0°C do +40°C
- ni primeren za vgradnjo v doze, globine 45 mm
- samo za notranjo uporabo



IR SWITCH 5A 230V~

- IR infrared switch
- supply voltage: 230V~ ±10 % 50Hz
- relay: 5A / 250V~ (zero crossing)
- protection rating: IP40
- cross-section of wires at the contact terminal: 0.75 - 2.5 mm²
- detection angle: up to 110° at 20°C
- detection area: approx. 8 m at 20°C
- adjustability of duration: from approx. 5 s to 12 min
- adjustability of brightness: from approx. 5 to 200 LUX
- operating temperature: from 0°C to +40°C
- not suitable for installation in 45 mm deep boxes
- only for indoor usage



- EE67PW
- EE67IW
- EE67NB
- EE67ES

POLNILNIK USB 5V 2,4A

- za polnjenje elektronskih naprav prek standardnega USB priključka (kompatibilno tudi z Apple napravami)
- napajanje: 100-230 V~ 50/60 Hz
- poraba med delovanjem: 300 mA pri 100 V~/150 mA pri 230 V~
- poraba v mirovanju: 30 mW pri 230 V~
- izhodna napetost: 5 VDC ($\pm 5\%$) SELV
- nihanje izhodne napetosti: 150 mV
- nominalni izhodni tok: 2,4 A ($\pm 10\%$)
- tip konektorja: USB A / USB A
- učinkovitost: maksimalno 77 %
- temperatura delovanja: 0 °C/+ 45 °C (notranja uporaba)
- IP zaščitni razred: IP20, samo za notranjo uporabo
- varnostni razred naprave II
- prenapetostna zaščita (EN 62109): razred III
- vijačna pritrditev vodnikov max. 2.5 mm²
- naprava z odmikom kontaktov min. 3 mm
- ustreza standardu EN 60950-1 in direktivam EMC in LVD



USB POWER SUPPLY UNIT 5V 2.4A

- for charging electronic devices via a standard USB port (also compatible with Apple devices)
- power supply: 100-230V~ 50/60Hz
- power consumption: 300mA at 100V~/150mA at 230V~
- standby power consumption: 30mW at 230V~
- nominal output voltage: 5 VCD ($\pm 5\%$) SELV
- output ripple voltage: 150mV
- nominal output current: 2.4A ($\pm 10\%$)
- connector type: USB A / USB A
- efficiency: maximum of 77%
- operating temperature: 0°C/+45°C (indoor use)
- IP protection class: IP20, indoor use only
- class device II
- overvoltage category (EN 62109): Class III
- screw contacts: max. 2.5 mm²
- device with a contact gap of at least 3mm
- in accordance with the EN 60950-1 and LVD & EMC directives

EE15, EE16, EE19

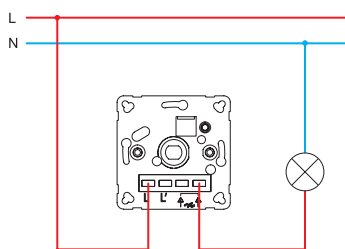

EE15, EE16, EE19

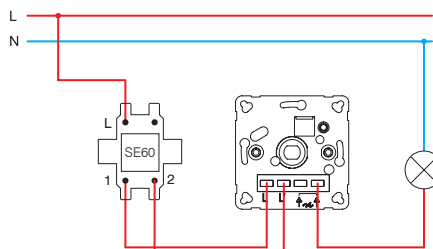

EE15, EE16, EE19

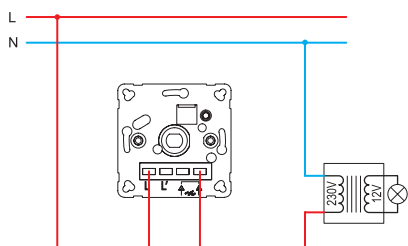

EE15, EE16, EE19

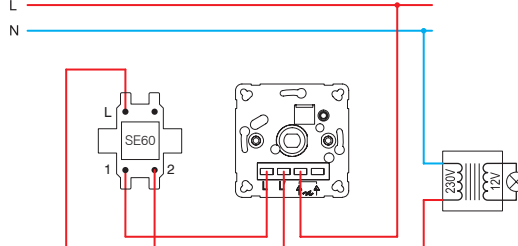

EE16, EE19

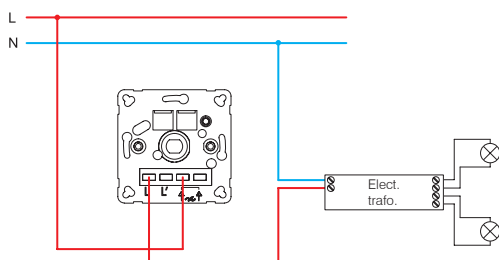

EE16, EE19

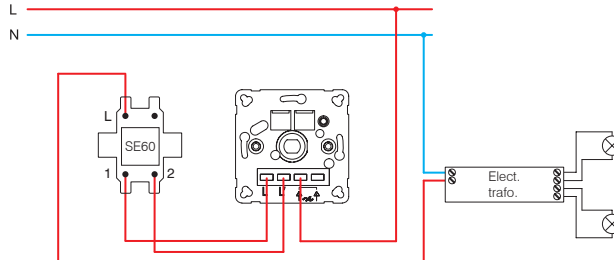

EE15 (40÷400W)

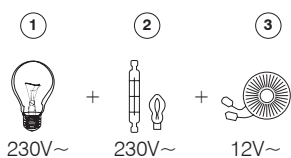

- 1 - žarnica z žarilno nitko /
incandescent lamp
2 - halogenska žarnica /
halogen lamp

EE16 (20÷400W)

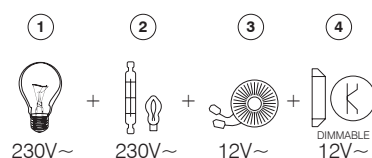

- 3 - klasični transformator /
classical transformer
4 - zatemnilni elektronski transformator /
dimmable electronic transformer

EE19 (GLS 10÷250W ; LED 0÷100W)

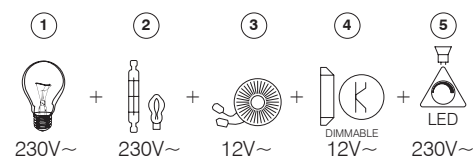

- 5 - zatemnilna LED sijalka /
dimmable LED lamp

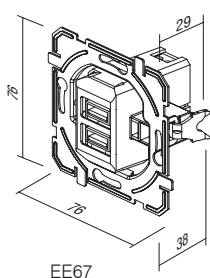

EE67

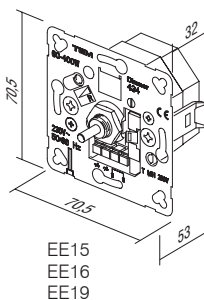
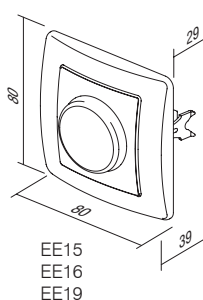
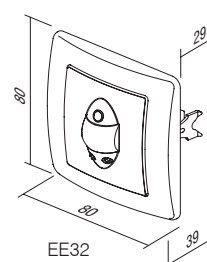
EE15
EE16
EE19EE15
EE16
EE19

EE32



PE41

PW

| tip type | naziv description | barva colour |
|-------------|---|---|
| PE41 | POKROV ZATEMNILNO STIKALO COVER DIMMER | <input type="checkbox"/> PW bela-sijaj polar white <input type="checkbox"/> IW bež-sijaj ivory white <input type="checkbox"/> ES srebrna-mat elox silver <input type="checkbox"/> CO beli duroplast white thermoset <input type="checkbox"/> NB črna-sijaj night black |

POKROV ZATEMNILNO STIKALO Ø6



- PE41PW
- PE41IW
- PE41NB
- PE41ES
- PE41CO

- pokrov zatemnilno stikalo Ø6mm
- za EE15, EE16, EE19

COVER DIMMER Ø6
- cover dimmer Ø6mm
- for EE15, EE16, EE19



POKROV IR STIKALO



- PE32PW
- PE32IW
- PE32NB
- PE32ES

- pokrov IR stikalo

COVER IR SWITCH
- cover IR switch



POKROV USB POLNILNIK



- PE67PW
- PE67IW
- PE67NB
- PE67ES

- USB polnilnik pokrov

USB SUPPLY UNIT COVER
- USB supply unit cover

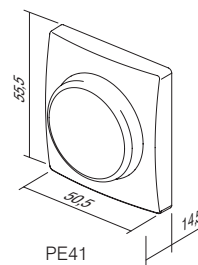
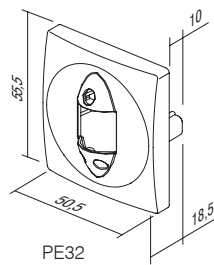
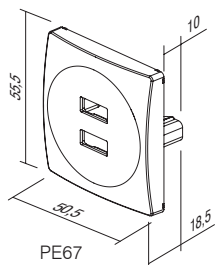

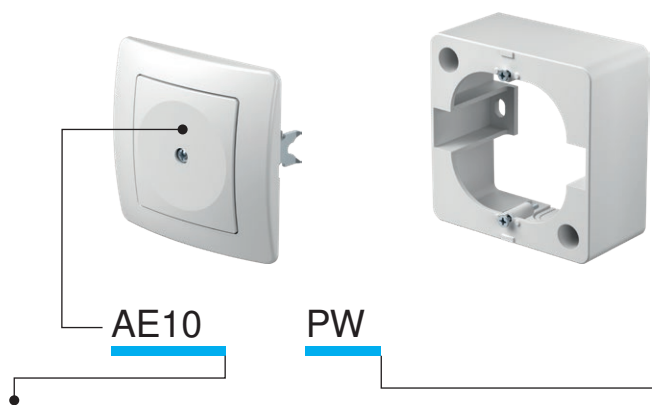

| tip type | naziv description | barva colour |
|-------------|--|---|
| AE10 | POLNILO BLANK | <input type="checkbox"/> PW bela-sijaj polar white |
| AE20 | PRIKLJUČEK PETPOLNI STALNI 3P+N+E 5X4mm ² CONNECTION BOX 3P+N+E 5X4mm ² | <input type="checkbox"/> IW bež-sijaj ivory white |
| AE30 | OHIŠJE NO 1 SURFACE MOUNT BOX | <input type="checkbox"/> ES srebrna-mat elox silver |
| ⋮ | ⋮ | <input type="checkbox"/> CO beli duroplast white thermoset |
| ⋮ | ⋮ | <input type="checkbox"/> NB črna-sijaj night black |

POLNILO



- AE10PW
- AE10IW
- AE10NB
- AE10ES
- AE10CO

- za pokrivanje praznih odprtín

BLANK

- for filling up empty spaces

PRIKLJUČEK PETPOLNI STALNI 3P+N+E 5x4mm²

- AE20PW
- AE20IW

- 3P+N+E stalni priključek

- 16A 400V~

- ustreza VDE 0601-1:2000

- vijajčna pritrditev vodnikov 1.5-4mm²CONNECTION BOX 5POLE 3P+N+E 5x4mm²

- 3P+N+E connection box

- 16A 400V~

- in accordance with VDE 0606-1:2000

- screw contacts 1.5-4mm²

OHIŠJE NADOMETNO 1

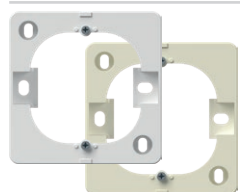

- AE30PW
- AE30IW

- nadometno ohišje

SURFACE MOUNT BOX 1

- surface mounting box



OHIŠJE NADOMETNO ZA DVOJNO VTIČNICO EKONOMIK

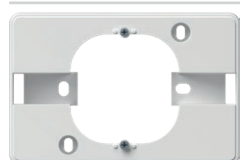

- AE31PW

- nadometno ohišje

SURFACE MOUNT BOX FOR

EKONOMIK DOUBLE SOCKET

- surface mounting box



STENSKI ŠČITNIK

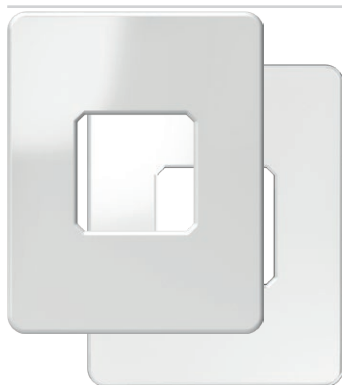

- AE50PW
- AE50TS

- ščitnik stene okoli stikala ali vtičnice

WALL PROTECTION

- protects surface around socket or switch

OTROŠKA ZAŠČITA KS



- AE51PW
- AE51IW

- KS otroška zaščita pred dotikom kontaktov

CHILD PROTECTION KS

- KS additional child protection insert - shuttered live contacts

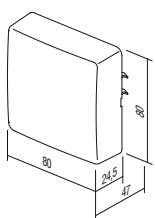

AE20

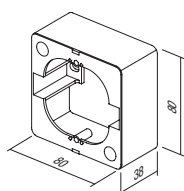

AE30

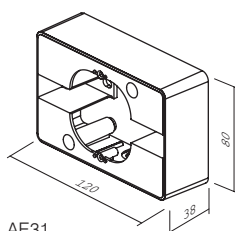

AE31

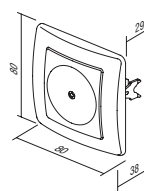

AE10

S U R R O U N D S O E



OE10



PW

| tip type | naziv description | barva colour |
|-------------|---|---|
| OE10 | OKVIR EKONOMIK 1 SURROUND EKONOMIK 1 | <input type="checkbox"/> PW bela-sijaj polar white |
| OE20 | OKVIR EKONOMIK 2 HORIZONTALNI SURROUND EKONOMIK 2 HORIZONTAL | <input type="checkbox"/> IW bež-sijaj ivory white |
| OE30 | OKVIR EKONOMIK 3 HORIZONTALNI SURROUND EKONOMIK 3 HORIZONTAL | <input type="checkbox"/> ES srebrna-mat elox silver |
| ⋮ | ⋮ | <input type="checkbox"/> CO beli duroplast white thermoset |
| ⋮ | ⋮ | <input type="checkbox"/> NB črna-sijaj night black |

OKVIR EKONOMIK 1



- OE10PW
- OE10IW
- OE10ES
- OE10CO
- OE10NB

- dekorativni enojni okvir
- ustreza EN 60669-1

SURROUND EKONOMIK 1
- decorative surround 1-gang
- in accordance with EN 60669-1

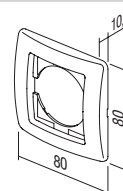

OKVIR EKONOMIK 2 HORIZONTALNI



- OE20PW
- OE20IW
- OE20ES
- OE20CO
- OE20NB

- dekorativni dvojni horizontalni okvir
- ustreza EN 60669-1

SURROUND EKONOMIK 2 HORIZONTAL
- decorative surround 2-gang horizontal
- in accordance with EN 60669-1

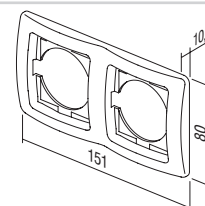

OKVIR EKONOMIK 2 VERTIKALNI



- OE21PW
- OE21IW
- OE21ES
- OE21CO
- OE21NB

- dekorativni dvojni vertikalni okvir
- ustreza EN 60669-1

SURROUND EKONOMIK 2 VERTICAL
- decorative surround 2-gang vertical
- in accordance with EN 60669-1

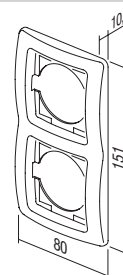

OKVIR EKONOMIK 3 HORIZONTALNI



- OE30PW
- OE30IW
- OE30ES
- OE30CO
- OE30NB

- dekorativni trojni horizontalni okvir
- ustreza EN 60669-1

SURROUND EKONOMIK 3 HORIZONTAL
- decorative surround 3-gang horizontal
- in accordance with EN 60669-1

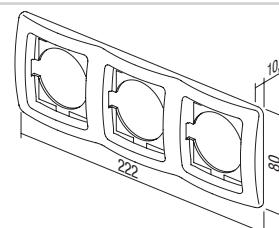



- OE31PW
- OE31IW
- OE31ES
- OE31CO
- OE31NB

OKVIR EKONOMIK 3 VERTIKALNI

- dekorativni trojni vertikalni okvir
- ustreza EN 60669-1

SURROUND EKONOMIK 3 VERTICAL

- decorative surround 3-gang vertical
- in accordance with EN 60669-1

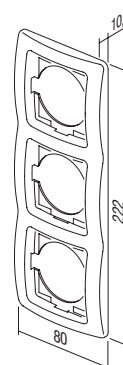

- OE40PW
- OE40IW
- OE40ES
- OE40NB

OKVIR EKONOMIK 4 HORIZONTALNI

- dekorativni četvorni horizontalni okvir
- ustreza EN 60669-1

SURROUND EKONOMIK 4 HORIZONTAL

- decorative surround 4-gang horizontal
- in accordance with EN 60669-1

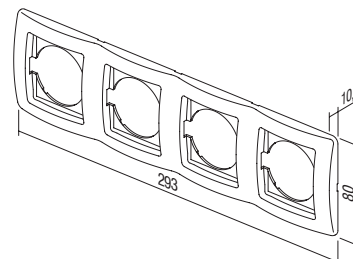

- OE41PW
- OE41IW
- OE41ES
- OE41NB

OKVIR EKONOMIK 4 VERTIKALNI

- dekorativni četvorni vertikalni okvir
- ustreza EN 60669-1

SURROUND EKONOMIK 4 VERTICAL

- decorative surround 4-gang vertical
- in accordance with EN 60669-1

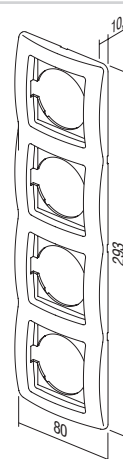

- OE50PW
- OE50IW
- OE50ES
- OE50NB

OKVIR EKONOMIK 5 HORIZONTALNI

- dekorativni 5-mestni horizontalni okvir
- ustreza EN 60669-1

SURROUND EKONOMIK 5 HORIZONTAL

- decorative surround 5-gang horizontal
- in accordance with EN 60669-1

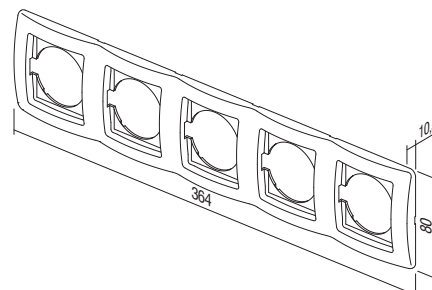

DEKORATIVNI OKVIRČKI COLOR /
 COLOR DECORATIVE FRAMES



OE90GR ZELENA /
 GREEN
 OE90BL MODRA /
 BLUE
 OE90VO VIJOLA /
 VIOLET
 OE90PI ROZA /
 PINK
 OE90RD RDEČA /
 RED

OE90YL RUMENA /
 YELLOW
 OE90WH BELA /
 WHITE
 OE90GY SIVA /
 GREY
 OE90BK ČRNA /
 BLACK

OE90MB MET. MODRA /
 MET. BLUE
 OE90BZ BRON /
 BRONZE
 OE90CR SREBRNA /
 SILVER
 OE90GO ZLATA /
 GOLD





fontana



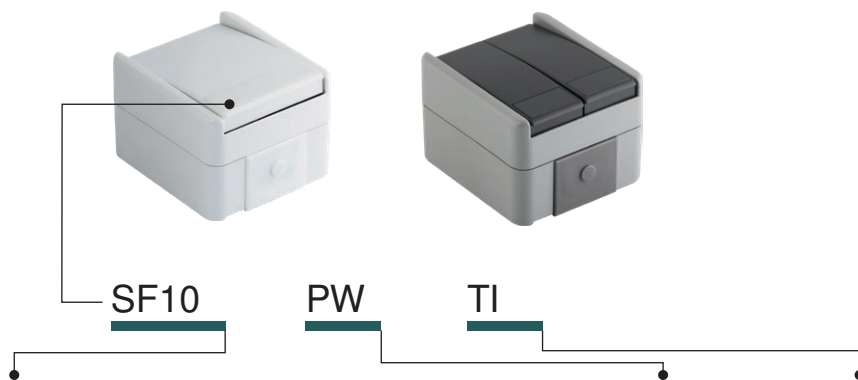

| tip type | naziv description | tehnični opis technical data | barva colour | opsijski opis 1 optional data 1 |
|-------------|--------------------------------------|---------------------------------|---|---|
| SF10 | STIKALO ENOPOLNO SWITCH 1WAY | IP44 10AX 250V~ | <input type="checkbox"/> PW bela-mat white-mat | TI tlivka+indikator neon lamp+indication |
| SF11 | TIPKALO ENOPOLNO PUSH BUTTON 1WAY | IP44 10A 250V~ | <input type="checkbox"/> GY siva-mat grey-mat | |
| SF20 | STIKALO DVOPOLNO SWITCH 2POLE | IP44 10AX 250V~ | | |
| : | : | : | | |
| : | : | : | | |

STIKALO ENOPOLNO IP44 10AX 250V~



- SF10PW
- SF10GY

- 10AX 250V~, tip SF10
- ustreza EN 60669-1
- brezvijačna pritrditev vodnikov 1.5-2.5mm²

SWITCH 1WAY IP44 10AX 250V~
- 10AX 250V~, type SF10
- in accordance with EN 60669-1
- plug-in contacts 1.5-2.5mm²



STIKALO ENOPOLNO IP44 10AX 250V~ __ TI



- SF10PWTI
- SF10GYTI

- TI indikator+tlivka
- 10AX 250V~, tip SF10
- ustreza EN 60669-1
- brezvijačna pritrditev vodnikov 1.5-2.5mm²

SWITCH 1WAY IP44 10AX 250V~ __ TI
- TI indicator+neon lamp
- 10AX 250V~, type SF10
- in accordance with EN 60669-1
- plug-in contacts 1.5-2.5mm²



TIPKALO ENOPOLNO IP44 10A 250V~ __ TI



- SF11PWTI
- SF11GYTI

- TI indikator+tlivka
- 10A 250V~, tip SF11
- ustreza EN 60669-1
- brezvijačna pritrditev vodnikov 1.5-2.5mm²

PUSH BUTTON 1WAY IP44 10A 250V~ __ TI
- TI indicator+neon lamp
- 10A 250V~, type SF11
- in accordance with EN 60669-1
- plug-in contacts 1.5-2.5mm²



STIKALO DVOPOLNO IP44 10AX 250V~















- SF20PW
- SF20GY

- 10AX 250V~, tip SF20
- ustreza EN 60669-1
- brezvijačna pritrditev vodnikov 1.5-2.5mm²

SWITCH 2POLE IP44 10AX 250V~
- 10AX 250V~, type SF20
- in accordance with EN 60669-1
- plug-in contacts 1.5-2.5mm²



| | | | |
|---|--|--|---|
|  | <ul style="list-style-type: none"> <input type="checkbox"/> SF50PW <input type="checkbox"/> SF50GY | <p>STIKALO SERIJSKO IP44 10AX 250V~</p> <ul style="list-style-type: none"> - 10AX 250V~, tip SF50 - ustreza EN 60669-1 - brezvijačna pritrditev vodnikov 1.5-2.5mm² <p><i>SWITCH 2GANG-1WAY IP44 10AX 250V~</i></p> <ul style="list-style-type: none"> - 10AX 250V~, type SF50 - in accordance with EN 60669-1 - plug-in contacts 1.5-2.5mm² |  |
|  | <ul style="list-style-type: none"> <input type="checkbox"/> SF51PW <input type="checkbox"/> SF51GY | <p>TIPKALO SERIJSKO IP44 10A 250V~</p> <ul style="list-style-type: none"> - 10A 250V~, tip SF51 - ustreza EN 60669-1 - brezvijačna pritrditev vodnikov 1.5-2.5mm² <p><i>PUSH BUTTON 2GANG-1WAY IP44 10A 250V~</i></p> <ul style="list-style-type: none"> - 10A 250V~, type SF51 - in accordance with EN 60669-1 - plug-in contacts 1.5-2.5mm² |  |
|  | <ul style="list-style-type: none"> <input type="checkbox"/> SF60PW <input type="checkbox"/> SF60GY | <p>STIKALO MENJALNO IP44 10AX 250V~</p> <ul style="list-style-type: none"> - 10AX 250V~, tip SF60 - ustreza EN 60669-1 - brezvijačna pritrditev vodnikov 1.5-2.5mm² <p><i>SWITCH 2WAY IP44 10AX 250V~</i></p> <ul style="list-style-type: none"> - 10AX 250V~, type SF60 - in accordance with EN 60669-1 - plug-in contacts 1.5-2.5mm² |  |
|  | <ul style="list-style-type: none"> <input type="checkbox"/> SF60PWTI <input type="checkbox"/> SF60GYTI | <p>STIKALO MENJALNO IP44 10AX 250V~ __ TI</p> <ul style="list-style-type: none"> - TI indikator+tlivka - 10AX 250V~, tip SF60 - ustreza EN 60669-1 - brezvijačna pritrditev vodnikov 1.5-2.5mm² <p><i>SWITCH 2WAY IP44 10AX 250V~ __ TI</i></p> <ul style="list-style-type: none"> - TI indicator+neon lamp - 10AX 250V~, type SF60 - in accordance with EN 60669-1 - plug-in contacts 1.5-2.5mm² |  |
|  | <ul style="list-style-type: none"> <input type="checkbox"/> SF63PW <input type="checkbox"/> SF63GY | <p>STIKALO DVOJNO MENJALNO IP44 10AX 250V~</p> <ul style="list-style-type: none"> - 10AX 250V~, tip SF63 - ustreza EN 60669-1 - brezvijačna pritrditev vodnikov 1.5-2.5mm² <p><i>SWITCH 2WAY DOUBLE IP44 10AX 250V~</i></p> <ul style="list-style-type: none"> - 10AX 250V~, type SF63 - in accordance with EN 60669-1 - plug-in contacts 1.5-2.5mm² |  |
|  | <ul style="list-style-type: none"> <input type="checkbox"/> SF70PW <input type="checkbox"/> SF70GY | <p>STIKALO KRIŽNO IP44 10AX 250V~</p> <ul style="list-style-type: none"> - 10AX 250V~, tip SF70 - ustreza EN 60669-1 - brezvijačna pritrditev vodnikov 1.5-2.5mm² <p><i>SWITCH INTERMEDIATE IP44 10AX 250V~</i></p> <ul style="list-style-type: none"> - 10AX 250V~, type SF70 - in accordance with EN 60669-1 - plug-in contacts 1.5-2.5mm² |  |

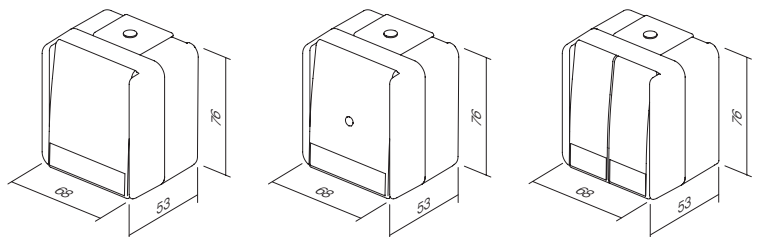



VF10

PW

| tip type | naziv description | tehnični opis technical data | barva colour |
|-------------|---|---------------------------------|---|
| VF10 | VTIČNICA SCHUKO+POKROV SOCKET SCHUKO+COVER | IP44 2P+E 16A 250V~ | <input type="checkbox"/> PW bela-mat white-mat <input type="checkbox"/> GY siva-mat grey-mat |



- VF10PW
- VF10GY

VTIČNICA SCHUKO+POKROV IP44 2P+E 16A 250V~

- vijajna pritrditev vodnikov 1.5-2.5mm²
- 2P+E schuko+pokrov
- 16A 250V~, tip VF10
- ustreza EN 60884-1, CEE7

SOCKET SCHUKO+COVER IP44 2P+E 16A 250V~

- screw contacts 1.5-2.5mm²
- 2P+E schuko+cover
- 16A 250V~, type VF10
- in accordance with EN 60884-1, CEE7



- VF12PW
- VF12GY

VTIČNICA SCHUKO+POKROV IP44 2P+E 16A 250V~ BV

- BV brezvijajna pritrditev vodnikov 1.5-2.5mm²
- 2P+E schuko+pokrov
- 16A 250V~, tip VF12
- ustreza EN 60884-1, CEE7

SOCKET SCHUKO+COVER IP44 2P+E 16A 250V~ BV

- BV plug-in contacts 1.5-2.5mm²
- 2P+E schuko+cover
- 16A 250V~, type VF12
- in accordance with EN 60884-1, CEE7

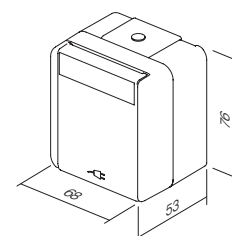

VF10
VF12

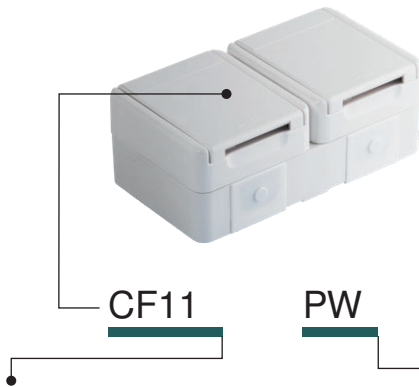

| tip type | naziv description | tehnični opis technical data | barva colour |
|-------------|--|---------------------------------|---|
| CF10 | SET VTIČNICA SCHUKO DVOJNA HORIZ SOCKET SET SCHUKO DOUBLE HORIZ | 2x 2P+E 16A 250V~ IP44 | <input type="checkbox"/> PW bela-mat white-mat |
| CF11 | SET VTIČNICA SCHUKO DVOJNA VERT SOCKET SET SCHUKO DOUBLE VERT | 2x 2P+E 16A 250V~ IP44 | <input checked="" type="checkbox"/> GY siva-mat grey-mat |
| CF12 | SET VTIČNICA SCH + STIKALO MEN HORIZ SOCKET SCH+SWITCH 2WAY HORIZ | 16A + 10A 250V~ IP44 | |
| ⋮ | ⋮ | ⋮ | |
| ⋮ | ⋮ | ⋮ | |

SET VTIČNICA SCHUKO DVOJNI HORIZONTALNI IP44 2x 2P+E 16A 250V~



- CF10PW
 CF10GY

- vijačna pritrditev vodnikov 1.5-2.5mm²
- 2x 2P+E schuko+pokrov horizontalni
- 16A 250V~, tip CF10
- ustreza EN 60884-1, CEE7

SOCKET SET SCHUKO DOUBLE
HORIZONTAL IP44 2x 2P+E 16A 250V~
- screw contacts 1.5-2.5mm²
- 2x 2P+E schuko+cover horizontal
- 16A 250V~, type CF10
- in accordance with EN 60884-1, CEE7



SET VTIČNICA SCHUKO DVOJNI VERTIKALNI IP44 2x 2P+E 16A 250V~



- CF11PW
 CF11GY

- vijačna pritrditev vodnikov 1.5-2.5mm²
- 2x 2P+E schuko+pokrov vertikalni
- 16A 250V~, tip CF11
- ustreza EN 60884-1, CEE7

SOCKET SET SCHUKO DOUBLE VERTICAL
IP44 2x 2P+E 16A 250V~
- screw contacts 1.5-2.5mm²
- 2x 2P+E schuko+cover vertical
- 16A 250V~, type CF11
- in accordance with EN 60884-1, CEE7



SET VTIČNICA SCH + STIKALO MEN HORIZONTALNI IP44 16A + 10AX 250V~



- CF12PW
 CF12GY

- vijačna (vtičnica), brezvijačna (stikalo) pritrditev vodnikov 1.5-2.5mm²
- 2P+E schuko+pokrov + stikalo menjalno horizontalni
- 16A + 10AX 250V~, tip CF12
- ustreza EN 60884-1, CEE7, EN 60669-1

SOCKET SCH+SWITCH SET 2WAY
HORIZONTAL IP44 16A + 10AX 250V~
- screw (socket), plug-in (switch)
contacts 1.5-2.5mm²
- 2P+E schuko+cover + switch 2-way horizontal
- 16A + 10AX 250V~, type CF12
- in accordance with EN 60884-1, CEE7, EN 60669-1



SET VTIČNICA SCH + STIKALO MEN VERTIKALNI IP44 16A + 10AX 250V~



- CF13PW
- CF13GY

- vijačna (vtičnica), brezvijačna (stikalo) pritrđitev vodnikov 1.5-2.5mm²
- 2P+E schuko+pokrov + stikalo menjalno vertikalni
- 16A + 10AX 250V~, tip CF13
- ustreza EN 60884-1, CEE7, EN 60669-1

SOCKET SCH+SWITCH 2WAY SET VERTICAL IP44 16A + 10AX 250V~

- screw (socket), plug-in (switch) contacts 1.5-2.5mm²
- 2P+E schuko+cover + switch 2-way vertical
- 16A + 10AX 250V~, type CF13
- in accordance with EN 60884-1, CEE7, EN 60669-1



SET VTIČNICA SCHUKO DVOJNI HORIZONTALNI IP44 2x 2P+E 16A 250V~ BV



- CF14PW
- CF14GY

- BV brezvijačna pritrđitev vodnikov 1.5-2.5mm²
- 2x 2P+E schuko+pokrov horizontalna
- 16A 250V~, tip CF14
- ustreza EN 60884-1, CEE7

SOCKET SET SCHUKO DOUBLE HORIZONTAL IP44 2x 2P+E 16A 250V~ BV

- BV plug-in contacts 1.5-2.5mm²
- 2x 2P+E schuko+cover horizontal
- 16A 250V~, type CF14
- in accordance with EN 60884-1, CEE7



SET VTIČNICA SCHUKO DVOJNI VERTIKALNI IP44 2x 2P+E 16A 250V~ BV



- CF15PW
- CF15GY

- BV brezvijačna pritrđitev vodnikov 1.5-2.5mm²
- 2x 2P+E schuko+pokrov vertikalna
- 16A 250V~, tip CF15
- ustreza EN 60884-1, CEE7

SOCKET SET SCHUKO DOUBLE VERTICAL IP44 2x 2P+E 16A 250V~ BV

- BV plug-in contacts 1.5-2.5mm²
- 2x 2P+E schuko+cover vertical
- 16A 250V~, type CF15
- in accordance with EN 60884-1, CEE7



SET VTIČNICA SCH + STIKALO MEN HORIZONTALNI IP44 16A + 10AX 250V~ BV



- CF16PW
- CF16GY

- BV brezvijačna pritrđitev vodnikov 1.5-2.5mm²
- 2P+E schuko+pokrov + stikalo menjalno horizontalni
- 16A + 10AX 250V~, tip CF16
- ustreza EN 60884-1, CEE7, EN 60669-1

SOCKET+SWITCH SET SCH+2WAY HORIZONTAL IP44 16A + 10AX 250V~ BV

- BV plug-in contacts 1.5-2.5mm²
- 2P+E schuko+cover + switch 2-way horizontal
- 16A + 10AX 250V~, type CF16
- in accordance with EN 60884-1, CEE7, EN 60669-1



SET VTIČNICA SCH+STIKALO MEN VERTIKALNI IP44 16A + 10AX 250V~ BV



- CF17PW
- CF17GY

- BV brezvijačna pritrđitev vodnikov 1.5-2.5mm²
- 2P+E schuko+pokrov + stikalo menjalno vertikalni
- 16A + 10AX 250V~, tip CF17
- ustreza EN 60884-1, CEE7, EN 60669-1

SOCKET SCH+SWITCH 2WAY SET VERTICAL IP44 16A + 10AX 250V~ BV

- BV plug-in contacts 1.5-2.5mm²
- 2P+E schuko+cover + switch 2-way vertical
- 16A + 10AX 250V~, type CF17
- in accordance with EN 60884-1, CEE7, EN 60669-1



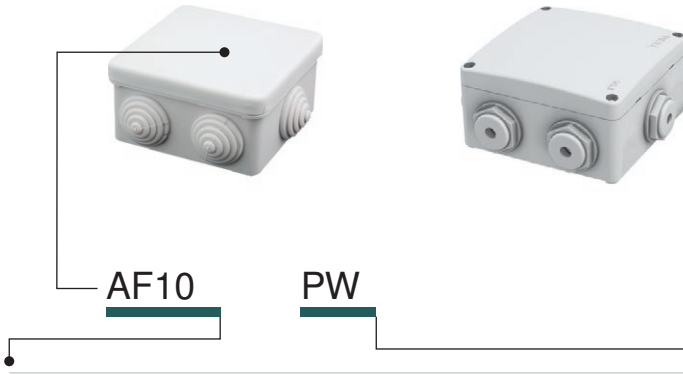

| tip type | naziv description | tehnični opis technical data | barva colour |
|-------------|--------------------------------|---------------------------------|---|
| AF10 | RAZVODNICA DISTRIBUTION BOX | IP44 RN01 | <input type="checkbox"/> PW bela-mat white-mat |
| AF20 | RAZVODNICA DISTRIBUTION BOX | IP55 NDO1 | <input type="checkbox"/> GY siva-mat grey-mat |

RAZVODNICA IP44 RN01



- AF10PW
- AF10GY

- nadometna razvodnica IP44
- 16A 400V~
- ustreza IEC/EN 60670-1, IEC/EN 60670-22

DISTRIBUTION BOX IP44 RN01

- surface mounting distribution box IP44
- 16A 400V~
- in accordance with IEC/EN 60670-1, IEC/EN 60670-22

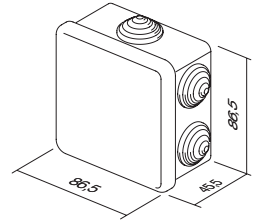

RAZVODNICA IP55 ND01



- AF20PW
- AF20GY

- nadometna razvodnica IP55
- uvodnice priložene
- ustreza IEC/EN 60670-1, IEC/EN 60670-22

DISTRIBUTION BOX IP55 ND01

- surface mounting connection box IP55
- glands included
- in accordance with IEC/EN 60670-1, IEC/EN 60670-22

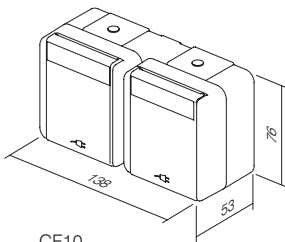
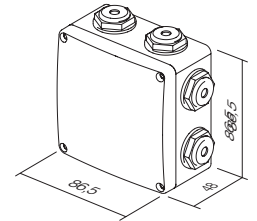

CF10
CF14

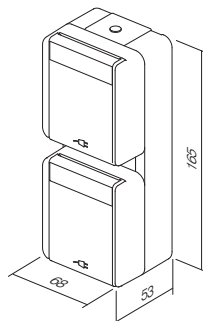

CF11
CF15

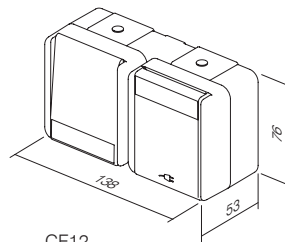

CF12
CF16

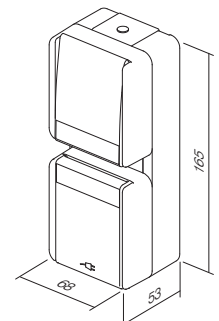

CF13
CF17

| šifra | opis izdelka | stran | šifra | opis izdelka | stran |
|-------------------------|---|-------|---------------------------------|---|-------|
| STIKALA SM | | | KOMUNIKACIJE KM | | |
| SM10 | STIKALO ENOPOLNO 16AX 250V- 1M | 50 | KM10-- | VTIČNICA TV OSNOVNA 0dB 1M | 64 |
| SM11 | TIPKALO ENOPOLNO 16A 250V- 1M | 50 | KM20-- | VTIČNICA TV OSNOVNA 0dB 2M | 64 |
| SM12 | STIKALO ENOPOLNO 20A 250V- 1M | 50 | KM11-- | VTIČNICA TV KONČNA 1dB 1M | 64 |
| SM20 | STIKALO DVOPOLNO 16AX 250V- 1M | 50 | KM12-- | VTIČNICA TV PREHODNA 10dB 1M | 64 |
| SM40 | STIKALO ŽALUZIJSKO 1-0-2 16AX 250V- 1M | 51 | KM15-- | VTIČNICA SAT OSNOVNA 0dB 1M | 65 |
| SM41 | TIPKALO ŽALUZIJSKO 1-0-2 16A 250V- 1M | 51 | KM24-- | VTIČNICA SAT OSNOVNA 0dB 2M | 65 |
| SM60 | STIKALO MENJALNO 16AX 250V- 1M | 51 | KM16-- | VTIČNICA SAT KONČNA 1dB 1M | 65 |
| SM61 | TIPKALO MENJALNO 16A 250V- 1M | 51 | KM19-- | VTIČNICA R OSNOVNA 0dB 1M | 65 |
| SM70 | STIKALO KRIŽNO 16AX 250V- 1M | 51 | KM29-- | VTIČNICA R OSNOVNA 0dB 2M | 65 |
| SM10-- | STIKALO ENOPOLNO 16AX 250V- 1M | 52 | KM25-- | VTIČNICA SAT-TV KONČNA 1dB 2M | 65 |
| SM10--IN | STIKALO ENOPOLNO 16AX 250V- 1M IN | 52 | KM22-- | VTIČNICA AVDIO 2xRCA 1M | 66 |
| SM11-- | TIPKALO ENOPOLNO 16A 250V- 1M | 52 | KM23-- | VTIČNICA AVDIO ZVOČNIŠKA 1M | 66 |
| SM11--IN01 | TIPKALO ENOPOLNO 16A 250V- 1M IN 01 | 52 | KM26-- | VTIČNICA AVDIO ZVOČNIŠKA 2M | 66 |
| SM11--IN02 | TIPKALO ENOPOLNO 16A 250V- 1M IN 02 | 53 | KM30-- | VTIČNICA TEL LT RJ11 6/4 1M | 67 |
| SM20--NT03 | STIKALO DVOPOLNO 16AX 250V- 1M NT 03 | 53 | KM31-- | VTIČNICA TEL BT SEC 6/6 1M | 67 |
| SM20--IN | STIKALO DVOPOLNO 16AX 250V- 1M IN | 53 | KM36-- | VTIČNICA TEL KS RJ11 6/4 1M | 67 |
| SM40--NT10 | STIKALO ŽALUZIJSKO 1-0-2 16AX 250V- 1M NT 10 | 53 | KM37-- | VTIČNICA CAT5e KS RJ45 8/8 1M | 67 |
| SM41--NT10 | TIPKALO ŽALUZIJSKO 1-0-2 16A 250V- 1M NT 10 | 53 | KM35-- | ADAPTER KS 1M | 67 |
| SM60-- | STIKALO MENJALNO 16AX 250V- 1M | 53 | KM38-- | ADAPTER KS S PRAŠNO ZAŠČITO 1M | 67 |
| SM61-- | TIPKALO MENJALNO 16A 250V- 1M | 54 | KM39-- | VTIČNICA CAT6 SCH KS RJ45 8/8 1M | 68 |
| SM62--CD | TIPKALO MENJALNO Z VRVICO 16A 250V- 1M CD | 54 | KM50-- | ADAPTER KS UNIVERZALNI 1M | 68 |
| SM70-- | STIKALO KRIŽNO 16AX 250V- 1M | 54 | KM40-- | ADAPTER PD 1M | 68 |
| TIPKE TM | | | KM43-- | ADAPTER PD S PRAŠNO ZAŠČITO 1M | 68 |
| TM11-- | TIPKA 1M | 55 | KM46-- | ADAPTER R&M 1M | 68 |
| TM11--IN | TIPKA 1M IN | 55 | KM52-- | ADAPTER R&M CAT6A 1M | 68 |
| TM12-- | TIPKA 2M | 55 | KM47-- | ADAPTER R&M S PRAŠNO ZAŠČITO 1M | 69 |
| TM12--IN | TIPKA 2M IN | 55 | KM53-- | ADAPTER R&M CAT6A S PRAŠNO ZAŠČITO 1M | 69 |
| TM13--IL | TIPKA 2M Z NAPISNO PLOŠČICO | 56 | KM45-- | ADAPTER LK 1M | 70 |
| TM15-- | TIPKA 1M DVOPOLNA | 56 | KA26 | ADAPTER NEXANS/SCRACK 2M | 70 |
| TM21-- | POLNILO 1M | 56 | KM48-- | ADAPTER AT&T SYSTIMAX S PRAŠNO ZAŠČITO 1M | 70 |
| TM22-- | POLNILO 2M | 56 | KM51-- | VTIČNICA USB TIP A 1M | 70 |
| TM31-- | UVODNICA 1M | 56 | KOMUNIKACIJSKI PRIBOR KA | | |
| SIGNALIZACIJA IA | | | KA10 | KONEKTOR KS CAT3 RJ11 6/4 | 71 |
| IA100R | TLIVKA 230V- 0,34W | 58 | KA11 | KONEKTOR KS CAT5e RJ45 8/8 | 71 |
| IA20-- | LED SIGNALIZACIJA 230V AC/DC 0,4W | 58 | KA12 | KONEKTOR KS CAT5eS RJ45 8/8 | 71 |
| IA21-- | LED SIGNALIZACIJA 24V AC/DC 0,2W | 58 | KA15 | KONEKTOR KS CAT6 SCHRACK RJ45 8/8 | 71 |
| IA22-- | LED SIGNALIZACIJA 12V AC/DC 0,10W | 58 | KA16 | KONEKTOR KS CAT6S SCHRACK RJ45 8/8 | 71 |
| IA50 | RC VEZJE 250V | 58 | KA17 | KONEKTOR KS CAT6a SCHRACK RJ45 8/8 | 71 |
| VTIČNICE VM | | | KA18 | KONEKTOR SLIM KS CAT6S SCHRACK RJ45 8/8 | 72 |
| VM10-- | VTIČNICA SCHUKO+KS 2P+E 16A 250V- 2M | 60 | KA27 | KONEKTOR KS HDMI | 72 |
| VM11-- | VTIČNICA SCHUKO+KS+POKROV 2P+E 16A 250V- 2M | 60 | KA28 | KABEL KS HDMI | 72 |
| VM20-- | VTIČNICA EURO+KS 2P 10A 250V- 1M | 61 | ELEKTRONIKA EM | | |
| VM40-- | VTIČNICA FRANCOSKA+KS 2P+E 16A 250V- 2M | 61 | EM12-- | ZATEMNILNIK ROTACIJSKI/MENJALNI RL 300W 1M | 73 |
| VM41-- | VTIČNICA FRANCOSKA+KS+POKROV 2P+E 16A 250V- 2M | 61 | EM13-- | ZATEMNILNIK ROTACIJSKI/MENJALNI LED 60W 1M | 73 |
| VM30-- | VTIČNICA ITALJANSKA P17/11+KS 2P+E 16A 250V- 1M | 61 | EM14-- | ZATEMNILNIK ROTACIJSKI/MENJALNI LED 180W 1M | 74 |
| VM31-- | VTIČNICA SCHUKO/ITA P17/11+KS 2P+E 16A 250V- 2M | 61 | EM15-- | ZATEMNILNIK ROTACIJSKI R 250W 1M | 74 |
| VM32-- | VTIČNICA SCHUKO/ITA P30+KS 2P+E 16A 250V- 2M | 62 | EM16-- | 1-10 V ZATEMNILNIK ROTACIJSKI MENJALNI | 75 |
| VM33-- | VTIČNICA ITALJANSKA P11+KS 2P+E 10A 250V- 1M | 62 | EM23 | ZATEMNILNIK VGRADNI R (250 W), (RC,RL 200VA) | 75 |
| VM21-- | VTIČNICA EURO/AMERIŠKA+KS 2P 16A 250V- 1M | 62 | EM17 | KRMILNI MODUL MZC za EM18 | 76 |
| VM52-- | VTIČNICA BRITANSKA BS 1363+KS 2P+E 13A 250V- 2M | 62 | EM18 | ZATEMNILNIK VGRADNI LED 250W | 76 |
| VM55-- | VTIČNICA VEČSTANDARDNA+KS 2P+E 13A 250V- 2M | 62 | EM19 | ZATEMNILNIK VGRADNI DC LED 96W | 77 |
| VM80 | PRENAPETOSTNA ZAŠČITA MPE MINI 275V/50Hz | 62 | EM25-- | STIKALO/ZATEMNILNIK UNIVERZALNI RLC 0-300W 2M | 78 |
| | | | EM26-- | TIPKALO UPRAVLJALNO 2M | 81 |
| | | | EM27 | FILTER OMRÉŽNIH MOTENJ | 81 |
| | | | EM25PPOL20 | SET STIKALO / ZATEMNILNIK UNIVERZALNI RLC 0-300W 2M PP OL20 | 81 |
| | | | EM31-- | IR STIKALO 5A 230V- 1M | 82 |
| | | | EM32-- | IR STIKALO 5A 230V- 2M | 82 |
| | | | EM37-- | TERMOSTAT OSNOVNI 6A 230V-2M | 84 |
| | | | EM38-- | TERMOSTAT OGREVANJE 5(2)A 230V- 2M | 85 |
| | | | EM39-- | TERMOSTAT OGREVANJE/HLAJENJE 3(1,5)A 230V- 2M | 85 |
| | | | NM39 | NOSILEC Z VIJAKI ZA TERMOSTATE FANTINI COSMI 3M | 86 |
| | | | EM40-- | KARTIČNO STIKALO ZA VARČEVANJE Z ENERGIJO 3A 250V- 3M | 86 |
| | | | EM47 | KARTIČA ISO | 86 |
| | | | EM44-- | KARTIČNO STIKALO ZA VARČEVANJE Z ENERGIJO RF HF 13,56MHz 3M | 87 |
| | | | EM49 | RELE ENOTA ZA KARTIČNO STIKALO 2x16A 250V | 87 |
| | | | EM45 | RAZDELILNIK SPL-1 | 87 |
| | | | EM60-- | VTIČNICA ZA BRIVNIK 230V~/120V- 3M | 88 |
| | | | EM67-- | POLNILNIK USB 5V 2,4A 1M | 88 |
| | | | EM68-- | POLNILNIK USB 5V 3,0A | 89 |
| | | | EM55 | LED ZASILNA SVETILKA 250V- 0,9W, NiCd 3h 7M | 89 |
| | | | EM57 | LED ZASILNA SVETILKA 230V- 50 Hz 0,5W, NIMH 2h 2M | 89 |
| | | | EM50-- | LED AMBIENTALNA ENOTA ENOBARVNA | 90 |
| | | | EM51-- | SVETILKA LED DVOBARVNA 250V- 2x0,4W 2M | 90 |
| | | | EM52-- | SVETILKA LED 3D DVOBARVNA 250V- 2x0,4W 2M | 90 |
| | | | EM71-- | STIKALO NA PRSTNI ODTIS BIOPASS 2M | 91 |
| | | | EM82-- | VEČOPRAVILNO ČASOVNO STIKALO EM82 | 92 |
| | | | EM80-- | STIKALO BREZDOTIČNO 10A 240V- | 94 |
| | | | EM81-- | STIKALO BREZDOTIČNO UPRAVLJALNO | 94 |
| | | | EM90-- | BRENČAČ 8VA 230V- 1M | 95 |
| | | | EM91-- | BRENČAČ 8VA 12V 1M | 95 |
| | | | EM92-- | ZVONEC 8VA 230V- 1M | 95 |
| | | | EM93-- | ZVONEC 8VA 12V 1M | 95 |
| | | | EM94-- | ELEKTRONSKI ZVONEC 230V- 6mA rms 1M | 96 |
| | | | EM95-- | REGULATOR GLASNOSTI ZA 100V AVDIO LINIJO 35W 2M | 96 |
| | | | EM96-- | REGULATOR GLASNOSTI NIZKOOHMSKI 4-8 Ω 35W 2M | 96 |

| šifra | opis izdelka | stran |
|-----------------------------------|---|-------|
| SETI CM | | |
| CM10-- | SET VTIČNIC 2x SCHUKO 2P+E 16A 250V- 4M | 97 |
| CM11-- | SET VTIČNIC 3x SCHUKO 2P+E 16A 250V- 7M | 97 |
| CM15 | SET VEZNIKOV BARVNI 3x1,5mm ² 1M | 98 |
| CM16 | SET VEZNIKOV BARVNI 3x2,5mm ² 2M | 98 |
| CM17 | SET VIJAKOV 3,5x20 | 98 |
| CM18 | SET VIJAKOV 3,5x35 | 98 |
| CM19 | SET VIJAKOV 3,5x50 | 98 |
| CM22-- | SET ZA STIKALA IP44 2M | 98 |
| CM23-- | SET ZA VTIČNICE IP44 2M | 98 |
| CM25--OL | KOPALNIŠKI SET 3x20A 250V- 4M OL | 98 |
| CM25--OS | KOPALNIŠKI SET 3x20A 250V- 4M OS | 98 |
| NM41 | NOSILEC KOPALNIŠKI SET 4M | 99 |
| OL41-- | OKVIR LINE KOPALNIŠKI SET | 99 |
| OS41-- | OKVIR SOFT KOPALNIŠKI SET | 99 |
| ANTIBAKTERIJSKI PROGRAM AW | | |
| TM11AW | TIPKA 1M | 101 |
| TM11AWIN | TIPKA 1M IN | 101 |
| TM12AW | TIPKA 2M | 101 |
| TM12AWIN | TIPKA 2M IN | 101 |
| TM21AW | POLNILO 1M | 101 |
| TM22AW | POLNILO 2M | 101 |
| VM10AW | VTIČNICA SCHUKO+KS 2P+E 16A 250V- 2M | 102 |
| VM11AW | VTIČNICA SCHUKO+KS+POKROV 2P+E 16A 250V- 2M | 102 |
| VM20AW | VTIČNICA EURO+KS 2P 10A 250V- 1M | 102 |
| KM11AW | VTIČNICA TV KONČNA 1dB 1M | 102 |
| KM35AW | ADAPTER KS 1M | 102 |
| OS20AW | OKVIR SOFT 2M | 103 |
| OS24AW | OKVIR SOFT 2x2M | 103 |
| OS26AW | OKVIR SOFT 3x2M | 103 |
| OS30AW | OKVIR SOFT 3M | 103 |
| OS40AW | OKVIR SOFT 4M | 103 |
| OS70AW | OKVIR SOFT 7M | 103 |
| OKVIRJI PURE OP | | |
| OP20-- | OKVIR PURE 2M | 106 |
| OP24-- | OKVIR PURE 2x2M | 106 |
| OP26-- | OKVIR PURE 3x2M | 106 |
| OP28-- | OKVIR PURE 4x2M | 106 |
| OP30-- | OKVIR PURE 3M | 107 |
| OP40-- | OKVIR PURE 4M | 107 |
| OP70-- | OKVIR PURE 7M | 107 |
| OP13-- | OKVIR PURE 1/3M | 107 |
| OP23-- | OKVIR PURE 2/3M | 107 |
| OKVIRJI LINE OL | | |
| OL20-- | OKVIR LINE 2M | 110 |
| OL24-- | OKVIR LINE 2x2M | 110 |
| OL26-- | OKVIR LINE 3x2M | 110 |
| OL28-- | OKVIR LINE 4x2M | 110 |
| OL29-- | OKVIR LINE 5x2M | 110 |
| OL30-- | OKVIR LINE 3M | 111 |
| OL40-- | OKVIR LINE 4M | 111 |
| OL70-- | OKVIR LINE 7M | 111 |
| OL71-- | OKVIR LINE 2x7M | 111 |
| OL10-- | OKVIR LINE 1/2M | 111 |
| OL13-- | OKVIR LINE 1/3M | 111 |
| OL23-- | OKVIR LINE 2/3M | 111 |
| OKVIRJI SOFT OS | | |
| OS20-- | OKVIR SOFT 2M | 114 |
| OS24-- | OKVIR SOFT 2x2M | 114 |
| OS26-- | OKVIR SOFT 3x2M | 114 |
| OS28-- | OKVIR SOFT 4x2M | 114 |
| OS30-- | OKVIR SOFT 3M | 115 |
| OS40-- | OKVIR SOFT 4M | 115 |
| OS70-- | OKVIR SOFT 7M | 115 |
| OS71 | OKVIR SOFT 2x7M | 115 |
| OS72-- | OKVIR SOFT 2x7M | 115 |
| OS10-- | OKVIR SOFT 1/2M | 116 |
| OS13-- | OKVIR SOFT 1/3M | 116 |
| OS23-- | OKVIR SOFT 2/3M | 116 |
| NOSILCI NM | | |
| NM20 | NOSILEC S KREMPELJCI 2M | 120 |
| NM21 | NOSILEC BREZ VIJAKOV 2M | 120 |
| NM24 | NOSILEC KOVINSKI S KREMPELJCI 2M | 120 |
| NM25 | NOSILEC KOVINSKI BREZ VIJAKOV 2M | 120 |
| NM10 | NOSILEC S KREMPELJCI 1/2M | 121 |
| NM11 | NOSILEC BREZ VIJAKOV 1/2M | 121 |
| NM23 | NOSILEC S KREMPELJCI 2/3M | 121 |
| NM30 | NOSILEC Z VIJAKI 3M | 122 |
| NM40 | NOSILEC Z VIJAKI 4M | 122 |
| NM70 | NOSILEC Z VIJAKI 7M | 122 |
| NM72 | NOSILEC Z VIJAKI 2x7M | 122 |
| NM32 | NOSILEC Z VIJAKI 2/3M | 122 |

D O Z E

| šifra | opis izdelka | stran |
|---------------------------|--|-------|
| OKROGLE DOZE | | |
| DE10 | DOZA OKROGLA ZA ZID SM60-01 | 126 |
| DE11 | DOZA OKROGLA ZA ZID GLOBOKA SM60-06 | 126 |
| DE30 | VEZNI ČLEN DOZE ZA ZID SM60-03 | 126 |
| DE31 | VEZNI ČLEN DOZE ZA ZID SM60-04 | 126 |
| DE12 | DOZA OKROGLA ZA ZID 65-46 | 127 |
| DE13 | DOZA OKROGLA ZA ZID 65-60 | 127 |
| DE14 | PODALJŠEK DOZE ZA ZID 65-46 | 127 |
| DE32 | VEZNI ČLEN DOZE ZA ZID 65-71 | 127 |
| DE33 | VEZNI ČLEN DOZE ZA ZID 65-91 | 127 |
| DE20 | POKROV DOZE ZAŠČITNI 60 | 127 |
| DE21 | POKROV DOZE ZAŠČITNI 65 | 127 |
| DE22 | POKROV DOZE DEKORATIVNI SM60 | 127 |
| HE10 | DOZA OKROGLA ZA VOTLE STENE SM68x40 | 130 |
| HE11 | DOZA OKROGLA ZA VOTLE STENE SM68x55 | 130 |
| BE10 | DOZA OKROGLA ZA BETON 60-49 | 130 |
| BE11 | DOZA OKROGLA ZA BETON 60-77 | 130 |
| BE20 | NOSILEC DOZE ZA BETON | 130 |
| BE21 | UVODNICA DOZE ZA BETON 16 | 130 |
| PRAVOKOTNE DOZE | | |
| DM30 | DOZA PRAVOKOTNA ZA ZID PM3 | 134 |
| DM31 | DOZA PRAVOKOTNA ZA ZID PM3-65 | 134 |
| DM40 | DOZA PRAVOKOTNA ZA ZID PM4 | 134 |
| DM41 | DOZA PRAVOKOTNA ZA ZID PM4-65 | 134 |
| DM70 | DOZA PRAVOKOTNA ZA ZID PM7 | 135 |
| DM71 | DOZA PRAVOKOTNA ZA ZID PM7-65 | 135 |
| DM72 | DOZA PRAVOKOTNA ZA ZID PM72-65 | 135 |
| DM80 | VEZNI ČLEN DOZE PM | 135 |
| DM33 | POKROV DOZE ZAŠČITNI PM3 | 136 |
| DM34 | POKROV DOZE DEKORATIVNI PM3 | 136 |
| DM43 | POKROV DOZE ZAŠČITNI PM4 | 136 |
| DM44 | POKROV DOZE DEKORATIVNI PM4 | 136 |
| DM73 | POKROV DOZE ZAŠČITNI PM7 | 136 |
| DM74 | POKROV DOZE DEKORATIVNI PM7 | 136 |
| DM75 | POKROV DOZE DEKORATIVNI PM72 | 137 |
| HM30 | DOZA PRAVOKOTNA ZA VOTLE STENE VM3 | 138 |
| HM40 | DOZA PRAVOKOTNA ZA VOTLE STENE VM4 | 138 |
| HM70 | DOZA PRAVOKOTNA ZA VOTLE STENE VM7 | 138 |
| HM72 | DOZA PRAVOKOTNA ZA VOTLE STENE VM72 | 138 |
| BM30 | DOZA PRAVOKOTNA ZA BETON BM3 | 139 |
| BM40 | DOZA PRAVOKOTNA ZA BETON BM4 | 139 |
| BM70 | DOZA PRAVOKOTNA ZA BETON BM7 | 139 |
| BM80 | PRITRDILNI ČLEN DOZ BM | 139 |
| BM82 | DISTANČNI PROFIL ZA DOZE | 139 |
| RAZVODNE DOZE | | |
| DW10 | RAZVODNA DOZA OKROGLA ZA ZID DSM78 | 142 |
| HW10 | RAZVODNA DOZA OKROGLA ZA VOTLE STENE SM78x45 | 142 |
| DE23 | POKROV DOZE DEKORATIVNI SM78 | 142 |
| DE24 | POKROV DOZE ZAŠČITNI 78 | 142 |
| HW20 | RAZVODNA DOZA KVADRATNA ZA ZID SM105x105 | 142 |
| PRIBOR ZA OŽIČENJE | | |
| UW10-- | ENOREDNE SPONKE ZAPRTE PC 2x2,5mm ² 10P | 144 |
| UW11-- | ENOREDNE SPONKE ZAPRTE PC 2x4mm ² 10P | 144 |
| UW12-- | ENOREDNE SPONKE ZAPRTE PC 2x6mm ² 10P | 144 |
| UW15-- | ENOREDNE SPONKE PA 2x2,5mm ² 12P | 144 |
| UW16-- | ENOREDNE SPONKE PA 2x4mm ² 12P | 144 |
| UW17-- | ENOREDNE SPONKE PA 2x6mm ² 12P | 144 |
| UW29-- | DVOREDNE SPONKE PP 1.0-4.0mm ² 12P | 144 |
| UW30-- | DVOREDNE SPONKE PP 1.5-6.0mm ² 12P | 144 |
| UW31-- | DVOREDNE SPONKE PP 2.5-10mm ² 12P | 144 |
| UW32-- | DVOREDNE SPONKE PP 4.0-16mm ² 12P | 144 |
| UW25-- | DVOREDNE SPONKE PA 1.0-4.0mm ² 12P | 145 |
| UW26-- | DVOREDNE SPONKE PA 1.5-6.0mm ² 12P | 145 |
| UW27-- | DVOREDNE SPONKE PA 2.5-10mm ² 12P | 145 |
| UW28-- | DVOREDNE SPONKE PA 4.0-16mm ² 12P | 145 |
| UW40-- | BREZVIJAČNE SPONKE PA 1.5mm ² 3P | 145 |
| UW41-- | BREZVIJAČNE SPONKE PA 1.5mm ² 5P | 145 |
| UW42-- | BREZVIJAČNE SPONKE PA 1.5mm ² 8P | 145 |
| UW45-- | BREZVIJAČNE SPONKE PA 2.5mm ² 3P | 145 |
| UW46-- | BREZVIJAČNE SPONKE PA 2.5mm ² 4P | 145 |
| UW47-- | BREZVIJAČNE SPONKE PA 2.5mm ² 5P | 145 |
| UW50-- | BREZVIJAČNE SPONKE PA 2.5mm ² 2/1P | 145 |

distribucija —

LOGIQ —

| šifra | opis izdelka | stran |
|--|--|-------|
| OHIŠJA CUBO IP20 AC | | |
| AC11-- | OHIŠJE NO CUBO Z DNOM IP20 1M | 148 |
| AC21-- | OHIŠJE NO CUBO Z DNOM IP20 2M | 148 |
| AC41-- | OHIŠJE NO CUBO Z DNOM IP20 4M | 148 |
| AC61-- | OHIŠJE NO CUBO Z DNOM IP20 6M | 148 |
| OHIŠJA CUBO IP55 AQ | | |
| AQ20-- | OHIŠJE NO CUBO IP55 2M | 149 |
| AQ22-- | OHIŠJE NO CUBO IP55 2x2M | 149 |
| AQ30-- | OHIŠJE NO CUBO IP55 3M | 149 |
| AQ21-- | OHIŠJE PO CUBO IP55 2M | 150 |
| AQ31-- | OHIŠJE PO CUBO IP55 3M | 150 |
| PARAPETNI KANALI ALUMINIJSKI MA | | |
| RT10 | ADAPTER MA 92 | 151 |
| RT12-- | OKVIR MA 92 2/3M | 151 |
| RT14-- | OKVIR MA 92 4M | 151 |
| RT17-- | OKVIR MA 92 7M | 151 |
| RT20-- | OSNOVA KANALA MA 130x65 | 152 |
| RT21-- | OSNOVA KANALA MA 165x65 | 152 |
| RT25-- | POKROV KANALA MA 92 | 152 |
| RT30 | PREGRAĐA MA 43 | 152 |
| RT31 | PREGRAĐA MA 43 AL | 152 |
| RT32 | PREGRAĐA MA 43 AL DVOJNA | 152 |
| RT35-- | KONČNI ELEMENT MA 130x65 | 153 |
| RT36-- | KONČNI ELEMENT MA 165x65 | 153 |
| RT38 | SET RAVNI VEZNI ELEMENT MA 65 | 153 |
| RT40-- | UNIVERZALNI KOT MA 130x65 | 153 |
| RT41-- | UNIVERZALNI KOT MA 165x65 | 153 |
| RT42 | OZEMLJITVENA SPONKA MA 2x A6.3 | 153 |
| RT43-- | L KOTNI ELEMENT MA 130x65 / 130 | 153 |
| RT44-- | L KOTNI ELEMENT MA 165x65 / 130 | 154 |
| RT47-- | L KOTNI ELEMENT MA 165x65 / 165 | 154 |
| RT45-- | T ELEMENT MA 130x65 / 130 | 154 |
| RT46-- | T ELEMENT MA 165x65 / 130 | 154 |
| RT48-- | T ELEMENT MA 165x65 / 165 | 154 |
| RT50-- | NOSILEC STEBRIČKA MA ENOJNI 130x65 / 130 | 155 |
| RT51-- | NOSILEC STEBRIČKA MA DVOJNI 130x65 | 155 |
| RT52-- | STEBRIČEK MA 130x65x500 | 155 |
| RT53-- | STEBRIČEK MA DVOJNI 130x65x500 | 155 |
| TALNE DOZE MT | | |
| RB50 | VGRADNO OHIŠJE TALNE DOZE 4M | 157 |
| RB60 | VLOŽEK TALNE DOZE 4M | 157 |
| RB65S1 | POKROV TALNE DOZE 4M | 157 |
| RB51 | VGRADNO OHIŠJE TALNE DOZE 7M | 157 |
| RB61 | VLOŽEK TALNE DOZE 7M | 157 |
| RB66S1 | POKROV TALNE DOZE 7M | 157 |
| RB52 | VGRADNO OHIŠJE TALNE DOZE 2X7M | 158 |
| RB62 | VLOŽEK TALNE DOZE 2X7M | 158 |
| RB67S2 | POKROV TALNE DOZE 2X7M | 158 |
| RB53 | VGRADNO OHIŠJE TALNE DOZE 4X7M | 158 |
| RB62 | VLOŽEK TALNE DOZE 2X7M | 158 |
| RB68S2 | POKROV TALNE DOZE 4X7M | 158 |
| RB55S1 | TALNA DOZA ZA DVOJNA TLA S POKROVOM 4M | 159 |
| RB60 | VLOŽEK TALNE DOZE 4M | 159 |
| RB56S1 | TALNA DOZA ZA DVOJNA TLA S POKROVOM 7M | 160 |
| RB61 | VLOŽEK TALNE DOZE 7M | 160 |
| RB57S2 | TALNA DOZA ZA DVOJNA TLA S POKROVOM 2X7M | 160 |
| RB62 | VLOŽEK TALNE DOZE 2X7M | 160 |
| RB58S2 | TALNA DOZA ZA DVOJNA TLA S POKROVOM 4X7M | 160 |
| RB62 | VLOŽEK TALNE DOZE 2X7M | 160 |
| RB10 | ADAPTER ZA DIN LETEV 35mm 1M | 161 |
| RB11 | ADAPTER ZA DIN LETEV 35mm 2M | 161 |

| šifra | opis izdelka | stran |
|-------------------------|---|-------|
| STIKALA SQ | | |
| SQ10--XO | STIKALO ENOPOLNO 10AX 250V- | 174 |
| SQ10--INXO | STIKALO ENOPOLNO 10AX 250V- __ IN | 174 |
| SQ11--XO | TIPKALO ENOPOLNO 10A 250V- | 174 |
| SQ11--IN01XO | TIPKALO ENOPOLNO 10A 250V- __ IN 01 | 174 |
| SQ11--IN02XO | TIPKALO ENOPOLNO 10A 250V- __ IN 02 | 175 |
| SQ22--IN03XO | STIKALO DVOPOLNO 16AX 250V- __ IN 03 | 175 |
| SQ50--XO | STIKALO SERIJSKO 10AX 250V- | 175 |
| SQ51--XO | TIPKALO SERIJSKO 10A 250V- | 175 |
| SQ52--NT09XO | STIKALO ŽALUZIJSKO 10AX 250V- __ NT 09 | 175 |
| SQ53--NT09XO | TIPKALO ŽALUZIJSKO 10A 250V- __ NT 09 | 175 |
| SQ60--XO | STIKALO MENJALNO 10AX 250V- | 175 |
| SQ63--XO | STIKALO DVOJNO MENJALNO 10AX 250V- | 176 |
| SQ70--XO | STIKALO KRIŽNO 10AX 250V- | 176 |
| SIGNALIZACIJA IA | | |
| IA10-- | TLIVKA 230V- 0,34W | 177 |
| IA20-- | LED SIGNALIZACIJA 230V- AC/DC 0,4W | 177 |
| IA21-- | LED SIGNALIZACIJA 24V AC/DC 0,2W | 177 |
| IA22-- | LED SIGNALIZACIJA 12V AC/DC 0,1W | 177 |
| VTIČNICE VQ | | |
| VQ10--XO | VTIČNICA SCHUKO 2P+E 16A 250V- __ XO | 180 |
| VQ11--XO | VTIČNICA SCHUKO+POKROV 2P+E 16A 250V- __ XO | 180 |
| VQ12--XO | VTIČNICA SCHUKO 2P+E 16A 250V- BV __ XO | 180 |
| VQ13--XO | VTIČNICA SCHUKO+POKROV 2P+E 16A 250V- BV __ XO | 180 |
| VQ16-- | VTIČNICA SCHUKO DVOJNA 2P+E 16A 250V- | 180 |
| VQ40--XO | VTIČNICA FRANCOŠKA 2P+E 16A 250V- __ XO | 181 |
| VQ41--XO | VTIČNICA FRANCOŠKA+POKROV 2P+E 16A 250V- __ XO | 181 |
| VQ42--XO | VTIČNICA FRANCOŠKA 2P+E 16A 250V- BV __ XO | 181 |
| VQ43--XO | VTIČNICA FRANCOŠKA+POKROV 2P+E 16A 250V- BV __ XO | 181 |
| VQ46--XO | VTIČNICA FRANCOŠKA DVOJNA 2P+E 16A 250V- | 181 |
| KOMUNIKACIJE KQ | | |
| KQ10--XO | VTIČNICA TV OSNOVNA 0dB | 182 |
| KQ11--XO | VTIČNICA TV-R KONČNA 1dB | 182 |
| KQ12--XO | VTIČNICA TV-R PREHODNA 10dB | 182 |
| KQ16--XO | VTIČNICA SAT-TV-R KONČNA 3dB | 182 |
| KQ22--XO | VTIČNICA AVDIO 2xRCA | 183 |
| KQ23--XO | VTIČNICA AVDIO ZVOČNIŠKA | 183 |
| KQ36--XO | VTIČNICA TEL KS RJ11 6/4 | 183 |
| KQ37--XO | VTIČNICA CAT5e KS RJ45 8/8 | 183 |
| KQ38--XO | VTIČNICA TEL KS DVOJNA 2x RJ11 6/4 | 183 |
| KQ39--XO | VTIČNICA CAT5e KS DVOJNA 2x RJ45 8/8 | 183 |
| KQ35--XO | VTIČNICA TEL LT RJ11 6/4 | 183 |
| KQ40--XO | VTIČNICA CAT6s KS RJ45 8/8 SLIM | 184 |
| KQ41--XO | VTIČNICA CAT6s KS DVOJNA 2x RJ45 8/8 SLIM | 184 |
| ELEKTRONIKA EQ | | |
| EQ15--XO | ZATEMNILNIK ROTACIJSKI MEN RL 400W | 185 |
| EQ16--XO | ZATEMNILNIK ROTACIJSKI MEN RLC 400W | 185 |
| EQ19--XO | ZATEMNILNIK ROTACIJSKI MEN LED 100W | 185 |
| EQ32--XO | IR STIKALO 5A 230V- | 187 |
| EQ35--XO | TERMOSTAT OGREVANJE 10A 230V- | 187 |
| EQ36--XO | TERMOSTAT OGREVANJE / HLAJENJE 5A 230V- | 187 |
| EQ37--XO | TERMOSTAT TALNO OGREVANJE 16A 230V- | 188 |
| EQ68--XO | POLNILNIK USB 5V 3,0A | 188 |
| PRIBOR PQ | | |
| PQ10--XO | POLNILO | 189 |
| PQ30-- | POKROV TAE/TDO | 189 |
| OKVIRJI OQ | | |
| OQ10-- | OKVIR LOGIQ 1 | 190 |
| OQ20-- | OKVIR LOGIQ 2 | 190 |
| OQ30-- | OKVIR LOGIQ 3 | 191 |
| OQ40-- | OKVIR LOGIQ 4 | 191 |
| OQ50-- | OKVIR LOGIQ 5 | 191 |

ekonomik

| šifra | opis izdelka | stran |
|-------------------------|--|-------|
| STIKALA SE | | |
| SE10 | STIKALO ENOPOLNO 10AX 250V- | 202 |
| SE11 | TIPKALO ENOPOLNO 10A 250V- | 202 |
| SE22 | STIKALO DVOPOLNO 16AX 250V- | 202 |
| SE50 | STIKALO SERIJSKO 10AX 250V- | 202 |
| SE51 | TIPKALO SERIJSKO 10A 250V- | 203 |
| SE52 | STIKALO ŽALUZIJSKO 10AX 250V- | 203 |
| SE53 | TIPKALO ŽALUZIJSKO 10A 250V- | 203 |
| SE60 | STIKALO MENJALNO 10AX 250V- | 203 |
| SE63 | STIKALO DVOJNO MENJALNO 10AX 250V- | 203 |
| SE70 | STIKALO KRIŽNO 10AX 250V- | 203 |
| SE10-- | STIKALO ENOPOLNO 10AX 250V- | 204 |
| SE10--IN | STIKALO ENOPOLNO 10AX 250V- IN | 204 |
| SE11-- | TIPKALO ENOPOLNO 10A 250V- | 204 |
| SE11--TI50 | TIPKALO ENOPOLNO 10A 250V- TI 50 | 204 |
| SE11--TI51 | TIPKALO ENOPOLNO 10A 250V- TI 51 | 204 |
| SE11--IL | TIPKALO ENOPOLNO 10A 250V- IL | 204 |
| SE22--IN03 | STIKALO DVOPOLNO 16AX 250V- IN 03 | 204 |
| SE50-- | STIKALO SERIJSKO 10AX 250V- | 205 |
| SE51-- | TIPKALO SERIJSKO 10A 250V- | 205 |
| SE52--NT09 | STIKALO ŽALUZIJSKO 10AX 250V- NT 09 | 205 |
| SE53--NT09 | TIPKALO ŽALUZIJSKO 10A 250V- NT 09 | 205 |
| SE60-- | STIKALO MENJALNO 10AX 250V- | 205 |
| SE63-- | STIKALO DVOJNO MENJALNO 10AX 250V- | 205 |
| SE70-- | STIKALO KRIŽNO 10AX 250V- | 205 |
| TIPKE TE | | |
| TE10-- | TIPKA NAVADNA | 206 |
| TE10--IN | TIPKA INDIKATOR | 206 |
| TE13--IL | TIPKA Z NAPISNO PLOŠČICO IL | 206 |
| TE11-- | TIPKA SERIJSKA | 206 |
| SIGNALIZACIJA IA | | |
| IA10-- | TLIVKA 230V- 0,34W | 207 |
| IA20-- | LED SIGNALIZACIJA 230V- AC/DC 0,4W | 207 |
| IA21-- | LED SIGNALIZACIJA 24V AC/DC 0,2W | 207 |
| IA22-- | LED SIGNALIZACIJA 12V AC/DC 0,1W | 207 |
| VTIČNICE VE | | |
| VE10--XO | VTIČNICA SCHUKO 2P+E 16A 250V- XO | 210 |
| VE11--XO | VTIČNICA SCHUKO+POKROV 2P+E 16A 250V- XO | 210 |
| VE12--XO | VTIČNICA SCHUKO 2P+E 16A 250V- BV XO | 210 |
| VE13--XO | VTIČNICA SCHUKO+POKROV 2P+E 16A 250V- BV XO | 210 |
| VE10-- | VTIČNICA SCHUKO 2P+E 16A 250V- | 210 |
| VE11-- | VTIČNICA SCHUKO+POKROV 2P+E 16A 250V- | 210 |
| VE12-- | VTIČNICA SCHUKO 2P+E 16A 250V- BV | 210 |
| VE13-- | VTIČNICA SCHUKO+POKROV 2P+E 16A 250V- BV | 210 |
| VE40--XO | VTIČNICA FRANCOSKA 2P+E 16A 250V- XO | 211 |
| VE41--XO | VTIČNICA FRANCOSKA+POKROV 2P+E 16A 250V- XO | 211 |
| VE42--XO | VTIČNICA FRANCOSKA 2P+E 16A 250V- BV XO | 211 |
| VE43--XO | VTIČNICA FRANCOSKA+POKROV 2P+E 16A 250V- BV XO | 211 |
| VE40-- | VTIČNICA FRANCOSKA 2P+E 16A 250V- | 211 |
| VE41-- | VTIČNICA FRANCOSKA+POKROV 2P+E 16A 250V- | 211 |
| VE42-- | VTIČNICA FRANCOSKA 2P+E 16A 250V- BV | 211 |
| VE43-- | VTIČNICA FRANCOSKA+KS+POKROV 2P+E 16A 250V- BV | 211 |
| VE16-- | VTIČNICA SCHUKO DVOJNA 2P+E 16A 250V- | 212 |
| VE46-- | VTIČNICA FRANCOSKA DVOJNA 2P+E 16A 250V- | 212 |
| VE30-- | VTIČNICA 2P 16A 250V- | 212 |
| KOMUNIKACIJE KE | | |
| KE11 | VTIČNICA TV-R KONČNA 1dB | 213 |
| KE12 | VTIČNICA TV-R PREHODNA 10dB | 213 |
| KE16 | VTIČNICA SAT-TV-R KONČNA 3dB | 213 |
| KE36 | VTIČNICA TEL KS RJ11 6/4 | 213 |
| KE37 | VTIČNICA CAT5e KS RJ45 8/8 | 214 |
| KE40 | VTIČNICA CAT6s KS RJ45 8/8 SLIM | 214 |
| KE38 | VTIČNICA TEL KS DVOJNA 2x RJ11 6/4 | 214 |
| KE39 | VTIČNICA CAT5e KS DVOJNA 2x RJ45 8/8 | 214 |
| KE41 | VTIČNICA CAT6s KS DVOJNA 2x RJ45 8/8 SLIM | 214 |
| KE45 | ADAPTER KS ENOJNI | 214 |
| KE46 | ADAPTER KS DVOJNI | 215 |
| KE47 | ADAPTER PD DVOJNI | 215 |
| KE10-- | VTIČNICA TV OSNOVNA 0dB | 216 |
| KE11-- | VTIČNICA TV-R KONČNA 1dB | 216 |
| KE12-- | VTIČNICA TV-R PREHODNA 10dB | 216 |
| KE16-- | VTIČNICA SAT-TV-R KONČNA 3dB | 216 |
| KE22-- | VTIČNICA AVDIO 2xRČA | 216 |
| KE23-- | VTIČNICA AVDIO ZVOČNIŠKA | 216 |
| KE36-- | VTIČNICA TEL KS RJ11 6/4 | 216 |
| KE37-- | VTIČNICA CAT5e KS RJ45 8/8 | 217 |
| KE40-- | VTIČNICA CAT6s KS RJ45 8/8 SLIM | 217 |
| KE38-- | VTIČNICA TEL KS DVOJNA 2x RJ11 6/4 | 217 |
| KE39-- | VTIČNICA CAT5e KS DVOJNA 2x RJ45 8/8 | 217 |
| KE41-- | VTIČNICA CAT6s KS DVOJNA 2x RJ45 8/8 SLIM | 217 |
| KE35-- | VTIČNICA TEL LT RJ11 6/4 | 217 |

| šifra | opis izdelka | stran |
|-------------------|-------------------|-------|
| POKROVI PE | | |
| PE10-- | POKROV TV-R 2P/3P | 218 |
| PE20-- | POKROV KS ENOJNI | 218 |
| PE21-- | POKROV KS DVOJNI | 218 |
| PE30-- | POKROV TAE/TDO | 218 |

| šifra | opis izdelka | stran |
|-----------------------|-------------------------------------|-------|
| ELEKTRONIKA EE | | |
| EE15 | ZATEMNILNIK ROTACIJSKI MEN RL 400W | 219 |
| EE16 | ZATEMNILNIK ROTACIJSKI MEN RLC 400W | 219 |
| EE19 | ZATEMNILNIK ROTACIJSKI MEN LED 100W | 220 |
| EE32 | IR STIKALO 5A 230V- | 220 |
| EE67 | POLNILNIK USB 5V 2,4A | 220 |
| EE15-- | ZATEMNILNIK ROTACIJSKI MEN RL 400W | 221 |
| EE16-- | ZATEMNILNIK ROTACIJSKI MEN RLC 400W | 221 |
| EE19-- | ZATEMNILNIK ROTACIJSKI MEN LED 100W | 221 |
| EE32-- | IR STIKALO 5A 230V- | 221 |
| EE67-- | POLNILNIK USB 5V 2,4A | 222 |

| šifra | opis izdelka | stran |
|-------------------------------|------------------------------|-------|
| POKROVI ELEKTRONIKE PE | | |
| PE41-- | POKROV ZATEMNILNO STIKALO Ø6 | 224 |
| PE32-- | POKROV IR STIKALO | 224 |
| PE67-- | POKROV USB POLNILNIK | 224 |

| šifra | opis izdelka | stran |
|------------------|--|-------|
| PRIBOR AE | | |
| AE10-- | POLNILO | 225 |
| AE20-- | PRIKLJUČEK PETPOLNI STALNI 3P+N+E 5x4mm ² | 225 |
| AE30-- | OHIŠJE NADOMETNO 1 | 225 |
| AE31-- | OHIŠJE NADOMETNO ZA DVOJNO VTIČNICO EKONOMIK | 225 |
| AE50-- | STENSKI ŠČITNIK | 226 |
| AE51-- | OTROŠKA ZAŠČITA KS | 226 |

| šifra | opis izdelka | stran |
|-------------------|-------------------------------|-------|
| OKVIRJI OE | | |
| OE10-- | OKVIR EKONOMIK 1 | 227 |
| OE20-- | OKVIR EKONOMIK 2 HORIZONTALNI | 227 |
| OE21-- | OKVIR EKONOMIK 2 VERTIKALNI | 227 |
| OE30-- | OKVIR EKONOMIK 3 HORIZONTALNI | 227 |
| OE31-- | OKVIR EKONOMIK 3 VERTIKALNI | 228 |
| OE40-- | OKVIR EKONOMIK 4 HORIZONTALNI | 228 |
| OE41-- | OKVIR EKONOMIK 4 VERTIKALNI | 228 |
| OE50-- | OKVIR EKONOMIK 5 HORIZONTALNI | 228 |
| OE90-- | DEKORATIVNI OKVIRČKI COLOR | 229 |

fontana

| šifra | opis izdelka | stran |
|--------------------|--|-------|
| STIKALA SF | | |
| SF10-- | STIKALO ENOPOLNO IP44 10AX 250V- | 232 |
| SF10--TI | STIKALO ENOPOLNO IP44 10AX 250V- TI | 232 |
| SF11--TI | TIPKALO ENOPOLNO IP44 10A 250V- TI | 232 |
| SF20-- | STIKALO DVOPOLNO IP44 10AX 250V- | 232 |
| SF50-- | STIKALO SERIJSKO IP44 10AX 250V- | 233 |
| SF51-- | TIPKALO SERIJSKO IP44 10A 250V- | 233 |
| SF60-- | STIKALO MENJALNO IP44 10AX 250V- | 233 |
| SF60--TI | STIKALO MENJALNO IP44 10AX 250V- TI | 233 |
| SF63-- | STIKALO DVOJNO MENJALNO 10AX 250V- | 233 |
| SF70-- | STIKALO KRIŽNO IP44 10AX 250V- | 233 |
| VTIČNICE VF | | |
| VF10-- | VTIČNICA SCHUKO+POKROV IP44 2P+E 16A 250V- | 234 |
| VF12-- | VTIČNICA SCHUKO+POKROV IP44 2P+E 16A 250V- BV | 234 |
| SETI CF | | |
| CF10-- | SET VTIČNICA SCHUKO DVOJNI HORIZONTALNI IP44 2x2P+E 16A 250V- | 235 |
| CF11-- | SET VTIČNICA SCHUKO DVOJNI VERTIKALNI IP44 2x2P+E 16A 250V- | 235 |
| CF12-- | SET VTIČNICA SCH + STIKALO MEN HORIZONTALNI IP44 16A + 10AX 250V- | 235 |
| CF13-- | SET VTIČNICA SCH + STIKALO MEN VERTIKALNI IP44 16A + 10AX 250V- | 236 |
| CF14-- | SET VTIČNICA SCHUKO DVOJNI HORIZONTALNI IP44 2x 2P+E 16A 250V-BV | 236 |
| CF15-- | SET VTIČNICA SCHUKO DVOJNI VERTIKALNI IP44 2x 2P+E 16A 250V- BV | 236 |
| CF16-- | SET VTIČNICA SCH + STIKALO MEN HORIZONTALNI IP44 16A + 10AX 250V- BV | 236 |
| CF17-- | SET VTIČNICA SCH+STIKALO MEN VERTIKALNI IP44 16A + 10AX 250V- BV | 236 |

| šifra | opis izdelka | stran |
|------------------|----------------------|-------|
| PRIBOR AF | | |
| AF10-- | RAZVODNICA IP44 RN01 | 237 |
| AF20-- | RAZVODNICA IP55 ND01 | 237 |



TEM

On/Off and everything in between

100% ELEKTRICNA

www.tem.si



TEM

On/Off and everything in between



[www](http://www.tem.si)



TEM

TEM ČATEŽ d.o.o.
Čatež 13, 8212 VELIKA LOKA
SLOVENIJA
tem@tem.si
www.tem.si

T +386(0)7 348 99 00

TEM

SLO

www.tem.si

